

Stationary Louver K Blade

Application and Design

EDK-402 is a weather louver designed to protect air intake and exhaust openings in building exterior walls. Design incorporates drainable head, K style blades, sloped sill and high free area to provide maximum resistance to rain and weather while providing minimum resistance to airflow. The EDK-402 is an extremely efficient louver with **AMCA LICENSED PERFORMANCE DATA** enabling designers to select and apply with confidence.

Standard Construction

- Frame** Heavy gauge extruded 6063-T5 aluminum, 4 in. x 0.081 in. nominal wall thickness
- Blades** K style, heavy gauge extruded 6063-T5 aluminum, 0.081 in. nominal wall thickness, positioned at 37° and 45° angles on approximately 4 in. centers
- Construction** . . . Mechanically fastened
- Birdscreen** 3/4 in. x 0.051 in. flattened expanded aluminum in removable frame, inside mount (rear)
- Finish** Mill
- Minimum Size** . . 12 in. W x 12 in. H
- Maximum Single Section Size** . . . 120 in. W or 120 in. H. (limited to 70 ft. sq.)

Options (at additional cost)

- A variety of bird and insect screens
- Blank off panel
- Clip angles
- Extended sill
- Filter rack
- Flanged frame
- Glazing adaptor
- Hinged frame
- Security bars
- Welded construction
- 0.125 in. nominal wall thickness
- A variety of architectural finishes including:
 - Clear anodize
 - Integral color anodize
 - Baked enamel paint
 - Kynar paint

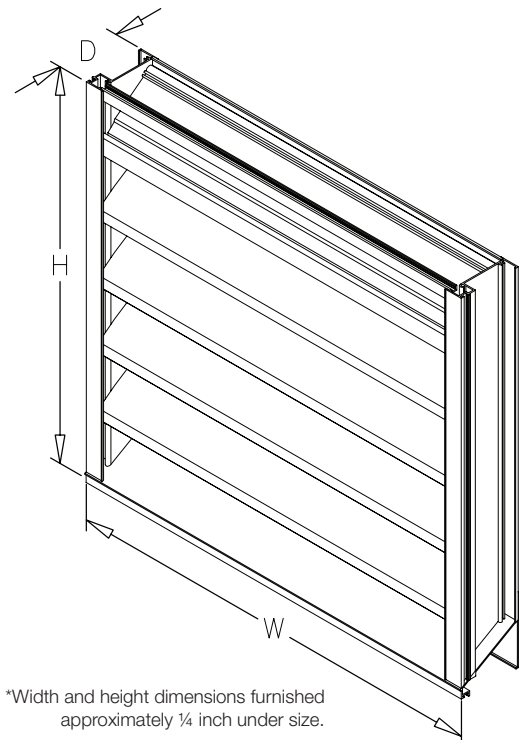
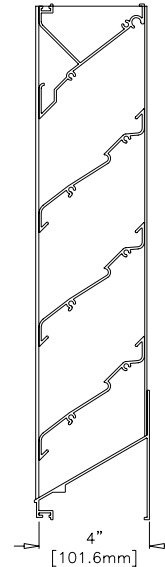

*Width and height dimensions furnished approximately 1/4 inch under size.

PERFORMANCE DATA

EDK-402

Stationary Louver K Blade
Extruded Aluminum

Free Area Chart (Sq. ft.)

Height in Inches	Width in Inches																		
	12	18	24	30	36	42	48	54	60	66	72	78	84	90	96	102	108	114	120
12	0.31	0.51	0.71	0.91	1.11	1.32	1.46	1.66	1.87	2.07	2.27	2.47	2.67	2.87	3.07	3.22	3.42	3.62	3.82
18	0.53	0.87	1.22	1.56	1.90	2.25	2.51	2.85	3.19	3.54	3.88	4.22	4.57	4.91	5.25	5.5	5.84	6.19	6.53
24	0.80	1.32	1.85	2.37	2.89	3.41	3.80	4.33	4.85	5.37	5.89	6.41	6.93	7.45	7.97	8.35	8.87	9.39	9.91
30	1.04	1.71	2.38	3.05	3.72	4.39	4.90	5.57	6.25	6.92	7.59	8.26	8.93	9.60	10.28	10.76	11.43	12.10	12.77
36	1.30	2.14	2.98	3.82	4.67	5.51	6.15	6.99	7.83	8.67	9.51	10.35	11.20	12.04	12.88	13.48	14.33	15.17	16.01
42	1.58	2.61	3.63	4.66	5.69	6.71	7.49	8.52	9.54	10.57	11.60	12.62	13.65	14.68	15.70	16.44	17.46	18.49	19.52
48	1.79	2.96	4.12	5.29	6.45	7.61	8.49	9.66	10.82	11.99	13.15	14.31	15.48	16.64	17.80	18.64	19.80	20.97	22.13
54	2.07	3.42	4.77	6.11	7.46	8.80	9.82	11.17	12.51	13.86	15.21	16.55	17.90	19.24	20.59	21.55	22.90	24.24	25.59
60	2.29	3.77	5.26	6.74	8.23	9.71	10.84	12.32	13.81	15.29	16.78	18.26	19.74	21.23	22.71	23.78	25.26	26.75	28.23
66	2.57	4.23	5.90	7.56	9.23	10.89	12.15	13.82	15.49	17.15	18.82	20.48	22.15	23.81	25.48	26.67	28.33	30.00	31.66
72	2.78	4.59	6.39	8.20	10.00	11.81	13.18	14.98	16.78	18.59	20.39	22.20	24.00	25.81	27.61	28.91	30.71	32.52	34.32
78	3.06	5.04	7.03	9.01	11.00	12.98	14.49	16.47	18.46	20.44	22.43	24.41	26.40	28.38	30.37	31.79	33.77	35.76	37.74
84	3.28	5.41	7.54	9.67	11.79	13.92	15.54	17.66	19.79	21.92	24.05	26.18	28.31	30.43	32.56	34.09	36.22	38.34	40.47
90	3.55	5.86	8.16	10.47	12.77	15.08	16.83	19.13	21.44	23.74	26.04	28.35	30.65	32.96	35.26	36.92	39.22	41.53	43.83
96	4.01	6.61	9.22	11.82	14.42	17.02	19.00	21.60	24.20	26.80	29.41	32.01	34.61	37.21	39.81	41.68	44.28	46.88	49.49
102	1.05	6.67	9.30	11.92	14.55	17.18	19.17	21.79	24.42	27.04	29.67	32.30	34.92	37.55	40.17	42.05	44.68	47.31	49.93
108	4.33	7.14	9.95	12.76	15.57	18.38	20.51	23.32	26.13	28.94	31.75	35.56	37.37	40.18	42.99	45.00	47.81	50.62	53.43
114	1.54	7.49	10.44	13.39	16.34	19.28	21.52	24.47	27.42	30.36	33.31	36.26	39.21	42.15	45.10	47.22	50.16	53.11	56.06
120	4.82	7.95	11.08	14.21	17.34	20.47	22.84	25.97	29.10	32.23	35.36	38.49	41.62	44.75	47.87	50.12	53.25	56.38	59.50



Greenheck Fan Corporation certifies that the EDK-402 louvers shown herein are licensed to bear the AMCA Seal. The ratings shown are based on tests and procedures performed in accordance with AMCA Publication 511 and comply with the requirements of the AMCA Certified Ratings Program. The AMCA Certified Ratings Seal applies to air performance and water penetration ratings.

Airflow Resistance (Standard Air - .075 lb/ft³)

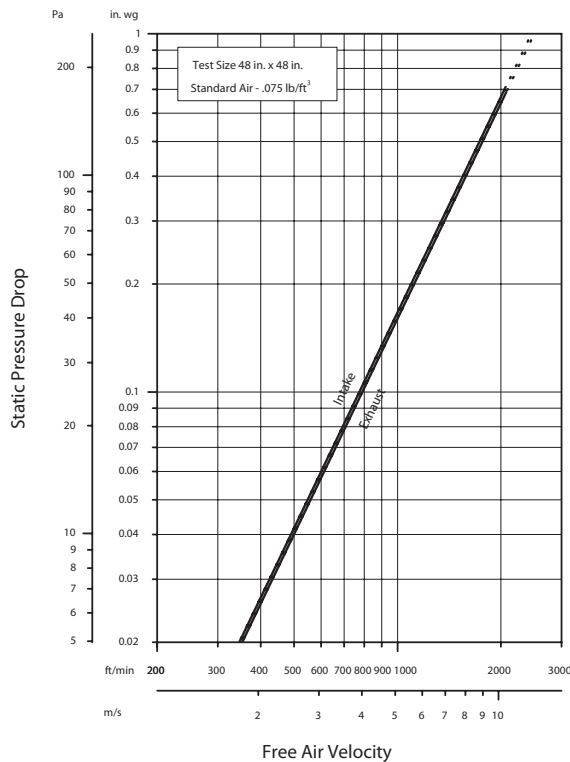

Model EDK-402 resistance to airflow (pressure drop) varies depending on louver application (air intake or air exhaust). Free area velocities (shown) are higher than average velocity through the overall louver size. See louver selection information.

Water Penetration (Standard Air - .075 lb/ft³)

Test size 48 in. x 48 in. Test duration of 15 min.

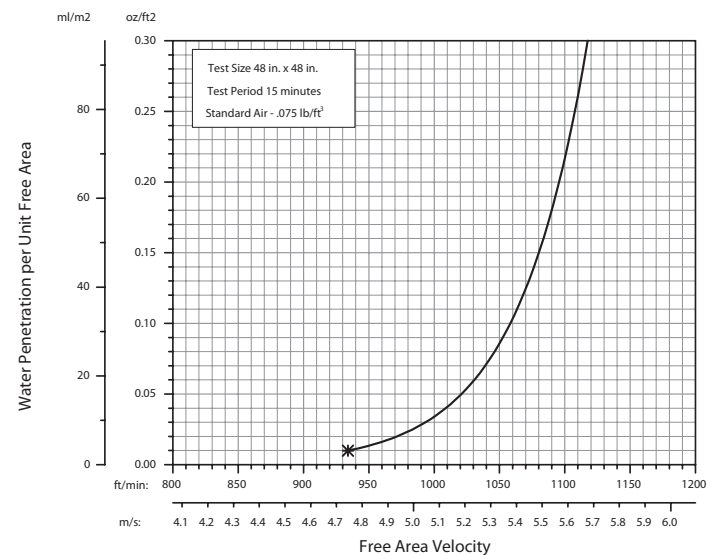

The AMCA Water Penetration Test provides a method for comparing various louver models and designs as to their efficiency in resisting the penetration of rainfall under specific laboratory test conditions. The beginning point of water penetration is defined as that velocity where the water penetration curve projects through .01 oz. of water (penetration) per sq. ft. of louver free area. ***The beginning point of water penetration for Model EDK-402 is 934 fpm free area velocity.** These performance ratings do not guarantee a louver to be weatherproof or stormproof and should be used in combination with other factors including good engineering judgement in selecting louvers.



INSTALLATION DETAILS

EDK-402

Stationary Louver K Blade
Extruded Aluminum

Maximum Size and Installation Information

Maximum single section size for model EDK-402 is 120 in. W x 84 in. H or 84 in. W x 120 in. H (70 sq. ft). Larger openings require field assembly of multiple louver sections to make up the overall opening size. Individual louver sections are designed to withstand a 25 PSF wind load (please consult Greenheck if the louvers must withstand higher wind-loads). Structural reinforcing members may be required to adequately support and install multiple louver sections within a large opening. Structural reinforcing members along with any associated installation hardware is not provided by Greenheck unless indicated otherwise by Greenheck. Options and accessories including, but not limited to, screens, filter racks, louver doors, and blank off panels are not subject to structural analysis unless indicated otherwise by Greenheck. Additional information on louver installation may be found in AMCA Publication #501, Louver Application Manual.

SINGLE SECTION
W/ SUPPORT ANGLES

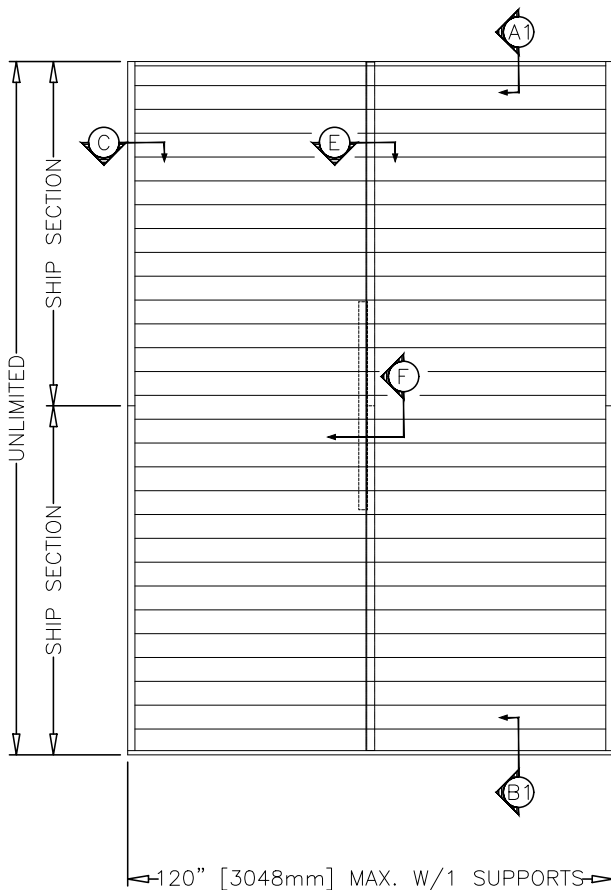

MULTIPLE SECTION W/ MULLION

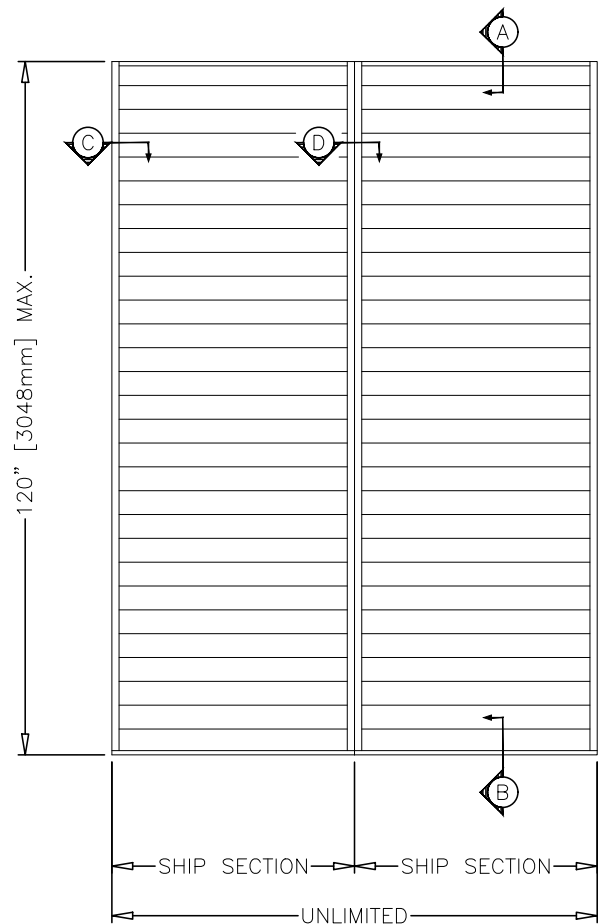

Minimum Single Section Size
12 in. W x 12 in. H

Maximum Single Section Size
70 ft. sq.

PRODUCT DETAILS

EDK-402

Stationary Louver K Blade
Extruded Aluminum

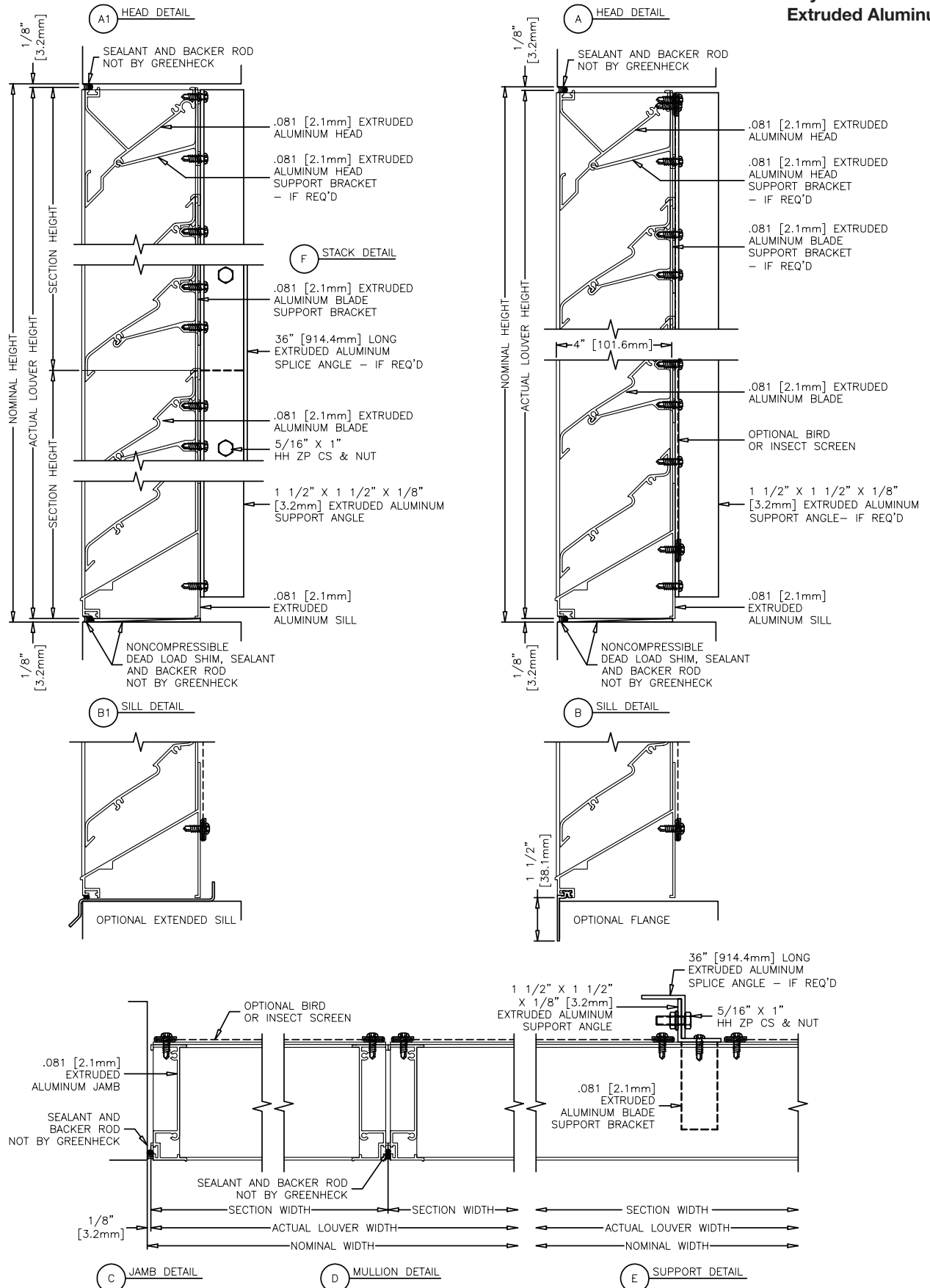

OPTION DRAWINGS

EDK-402 Stationary Louver K Blade Extruded Aluminum

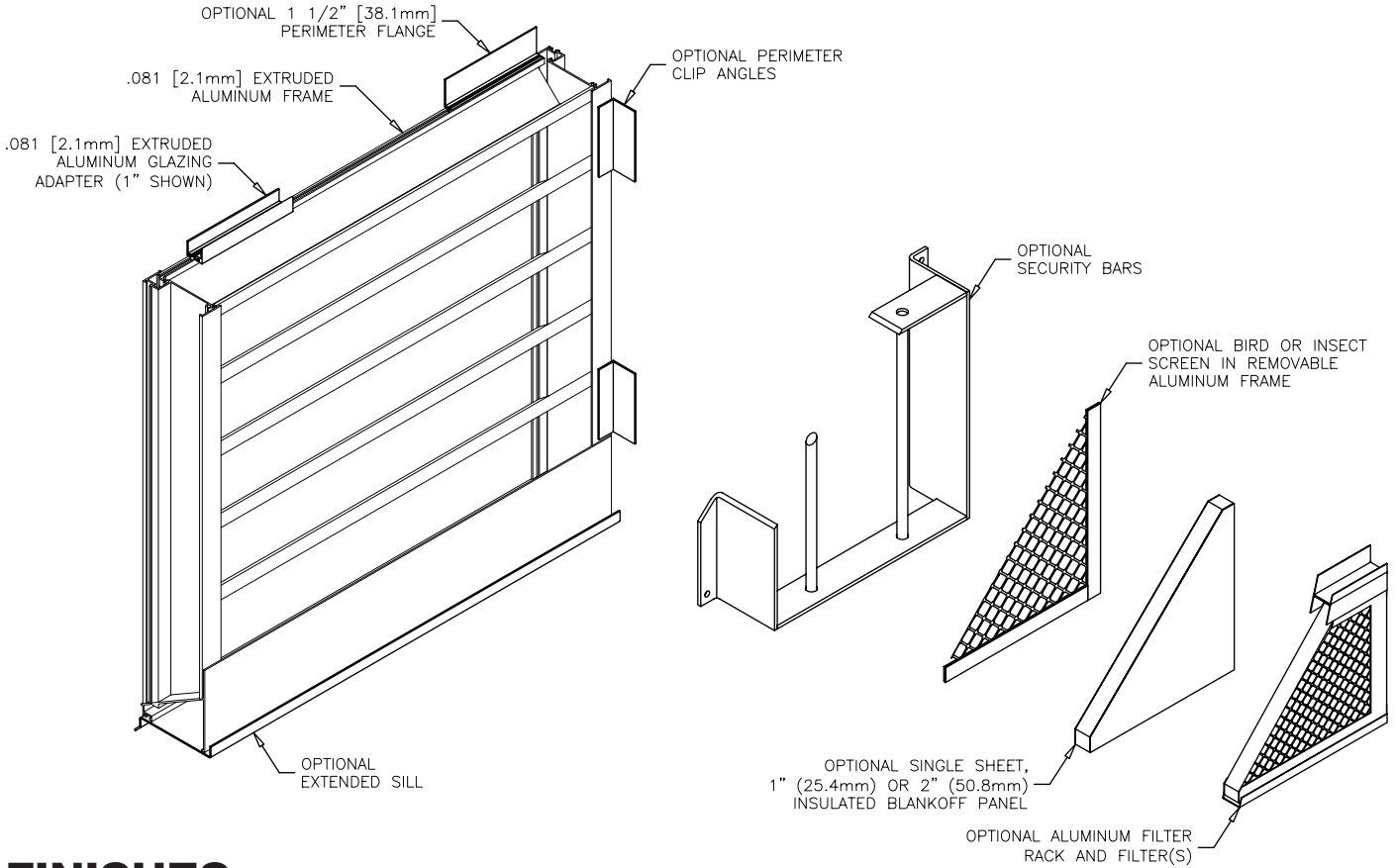

FINISHES

Finish Type	Description/Application	Color Selection	Standard Warranty (Aluminum)
AAMA 2605 100% Fluoropolymer (FEVE) 2-Coat 70% Kynar® (PVDF) 3-Coat 70% Kynar® (PVDF) 4-Coat 70% Kynar® (PVDF)	"Best." The premier finish for extruded aluminum. Tough, long-lasting coating has superior color retention and abrasive properties. Resists chalking, fading, chemical abrasion and weathering.	Standard Colors: Any of the 27 standard colors shown can be furnished in 70% or 50% Kynar®, 100% Fluoropolymer or Baked Enamel.	10 Years (20 Years Optional)
AAMA 2604 50% Kynar® / Acroflur®	"Better." Tough, long-lasting coating has excellent color retention and abrasive properties. Resists chalking, fading, chemical abrasion and weathering.	Mica Colors: Greenheck offers 6 standard Mica colors for 70% Kynar® or 100% Fluoropolymer.	5 Years
AAMA 2603 Baked Enamel	"Good." Provides good adhesion and resistance to weathering, corrosion and chemical stain.	Custom Colors: Custom color matching is available. Consult your Greenheck representative for cost and/or lead-time implications if a custom color is required.	1 Year
AA-M10C22A42 Integral Color Anodize	"Two-step" anodizing is produced by following the normal anodizing step with a second, colorfast process.	Light, Medium, Dark or Extra Dark Bronze; Champagne; Black	5 years
AA-M10C22A41 Clear Anodize 215 R-1	Clear, colorless and hard oxide aluminum coating that resists weathering and chemical attack.	Clear	5 years
AA-M10C22A31 Clear Anodize 204	Clear, colorless and hard oxide aluminum coating that resists weathering and chemical attack.	Clear	1 Year
Prime Coat	Louvers or architectural products shall be cleaned, pre-treated and receive a prime coat finish suitable for field painting. Greenheck does not recommend prime coat or field painting of materials.		n/a
Mill	Materials may be supplied in natural aluminum or galvanized steel finish when normal weathering is acceptable and there is no concern for color or color change.		n/a

Finishes meet or exceed AAMA 2605, AAMA 2604, and AAMA 2603 requirements. Please consult www.greenheck.com for complete information on standard and extended paint warranties. Paint finish warranties are not applicable to steel products.

