

IN PARTNERSHIP WITH YOU

JAESUNG ALUMINUM CURTAIN WALL & LOUVER



JEASUNG ALUMINUM.CO.LTD.



Leading the Era of Technology and Quality, JAESUNG Aluminum CO., Ltd.



Established in 1992 as Jaesung Aluminum LLC, Jaesung Aluminum Co., Ltd. becomes an expert of aluminum window system, growing continuously for 20 years.



Based on the accumulated aluminum window design and construction technology, we continuously grow with manufacturing and construction for various types of windows such as curtain wall of building, window of condensation preventing system, louver of nuclear power plant, and etc.



We promise to provide satisfaction and trust with high-technology and high-quality manufacturing and construction

CEO SEUNG-GOO, BAEG

-Company History -

- 1992.06 Established JAESUNG Aluminum Ltd. By representative
- 2000.09 Changed organization as JAESUNG Aluminum Co., Ltd. (capital 1.1 million won)
- 2000.12 Changed trade name as JAESUNG Aluminum Co., Ltd.
- 2004.12 Increased capital to 2 million won.
- 2008.03 Moved location of main office to #913, 1144-5 Guwol-dong, Namdong-gu, Incheon City.
- 2012.09 Moved location of main office to 45-43 No.225gil Gyeondalsan-ro Ilsandong-gu, Goyang City, Gyeonggi province.
- 2015.11 AMCA Membership.

- I N D E X -

1	JSA-A-100 Series	4
2	JSA-A'-100 Series	9
3	JSA-C-100 Series	14
4	JSA-D-100 Series	20
5	JSA-E-100 Series	25
6	JSA-F-100 Series	30

- DELIVERY PERFORMANCE -



Gyeong-In National University
of Education #2 Campus

Construction company
Hyundai Engineering & Construction



Dorasan Station

Construction company
Hyundai Development



Geumgang Mt. Myeonhoeso

Construction company
Hyundai Engineering & Construction



Cheon-An Museum

Construction company
Hyundai Engineering & Construction



Chang-Won FC

Construction company
Hyundai Engineering & Construction

- DELIVERY PERFORMANCE -



KT Gwa-Cheon Smart Tower

Construction company
Dong-bu Construction



Dongbu hwajae Data Center

Construction company
Dong-bu Construction



Incheon Children Science
Museum

Construction company
Dong-bu Construction



Seoul Womens University

Construction company
Hyundai Engineering & Construction



Hwaseong Sports Complex

Construction company
Hyundai Engineering & Construction

- DELIVERY PERFORMANCE -



VHS Medical Center

Construction company
Hyundai Engineering & Construction



Goyang Sports Complex

Construction company
Hyundai Engineering & Construction



Ahn LAB & Solid

Construction company
Hyundai Engineering & Construction



Seoul Womens University

Construction company
Hyundai Engineering & Construction



SHIN-KORI NUCLEAR POWER
PLANT UNIT NO. 3,4

Construction company
Hyundai Engineering & Construction
SK Construction
Doosan Heavy Industries & Construction

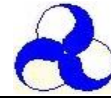

Stationary and Adjustable Louvers

JSA-A-100s



Jaesung Aluminum Co.,Ltd certifies that Model JSA-A-100s Louver shown herein is licensed to bear the AMCA Seal for Model JSA-A-100s. The ratings shown are based on tests and procedures performed in accordance with AMCA Publication 511 and comply with the requirements of the AMCA Certified Ratings Program.

The AMCA Certified Ratings Seal applies to Air Performance and Water Penetration Ratings.

Test Information

Test for air performance in accordance with ANSI/AMCA Standard 500-L-12(Pressure Drop), Figure 5.5.

Test for water penetration in accordance with ANSI/AMCA Standard 500-L-07, Figure 5.6.

Construction Standard

FRAME:

Gauge 12(3.2mm thick) formed extruded aluminum profiles.(A6063-T5)

BLADES:

Gauge 15(2.0mm thick) formed extruded aluminum profiles.(A6063-T5)

SCREEN:

Stainless steel bird screen 1/2"~3/4"(12~19) fiexd infont or behind the blades.

Please note that Pressure Drop Data is obtained form Test without bird screen.

Pressure drop of bird screen is additive and to be caculated separately.

MINIMUM SIZE:

300 X 300mm(12in X 12in) - Neck Size

MAXIMUM SIZE:

2100 X 2900mm as single section(Neck Size)
2 section more module consult JAS for multiple section assembly details.

Catalog ID : JSA-A-100 July 2016

JSA-A-100s



Optional Extras

***Code A**

Finished to Anodizing.

***Code P**

Painted to PVDF.

***Code I**

Insect screen in aluminum.

***Code B**

Bird screen in stainless steel.

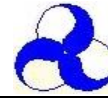

Stationary and Adjustable Louvers

JSA-A-100s



Jaesung Aluminum Co.,Ltd certifies that Model JSA-A-100s Louver shown herein is licensed to bear the AMCA Seal for Model JSA-A-100s. The ratings shown are based on tests and procedures performed in accordance with AMCA Publication 511 and comply with the requirements of the AMCA Certified Ratings Program.

The AMCA Certified Ratings Seal applies to Air Performance and Water Penetration Ratings.

Test Information

Test for Air Performance in accordance with ANSI/AMCA Standard 500-L-12(Pressure Drop), Figure 5.5.

Test sample size is 48 in X 48 in.(W1 X H1). Data at standard air density.

Air Performance

Pressure Drop

Intake Air Performance

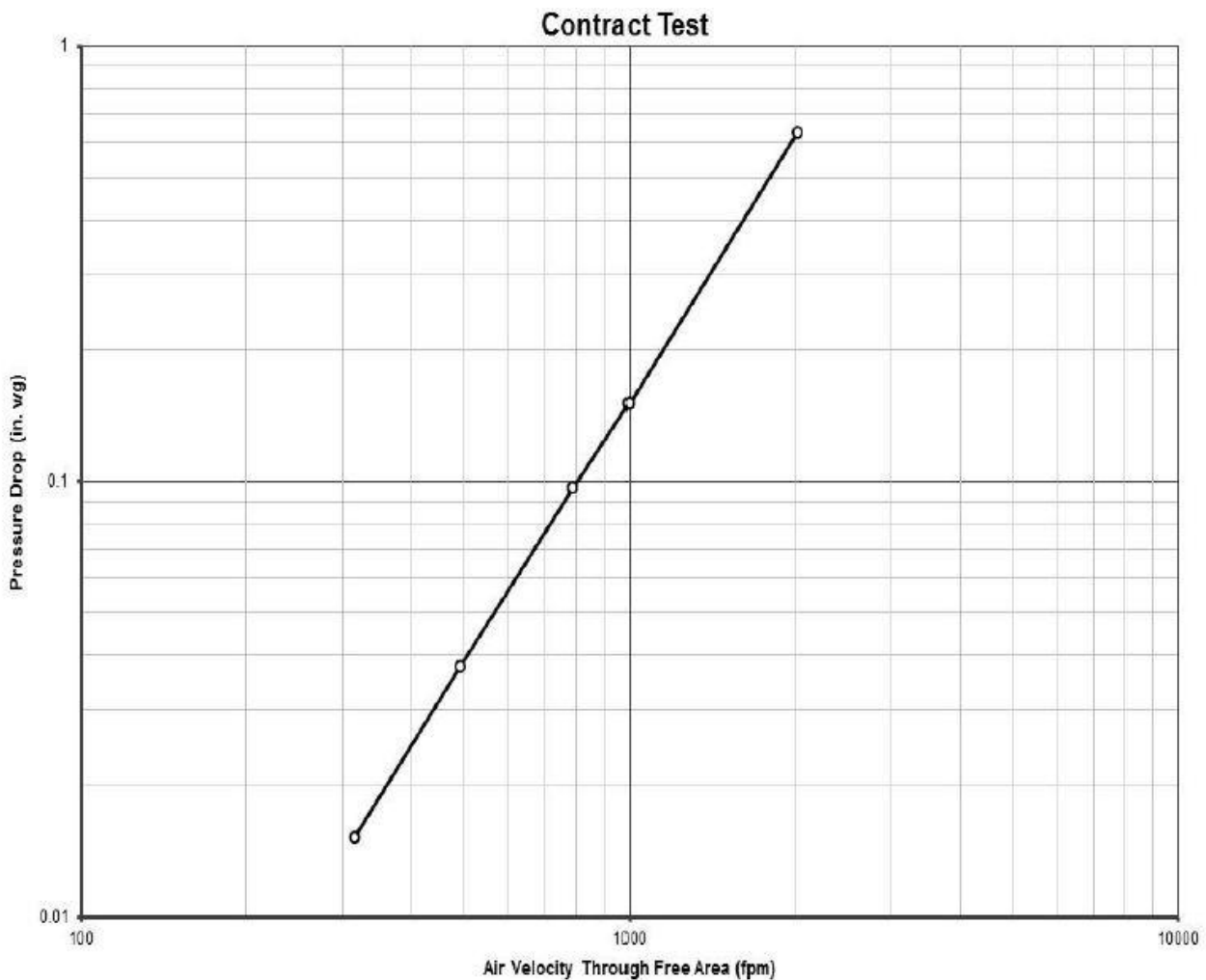



Stationary and Adjustable Louvers

JSA-A-100s



Jaesung Aluminum Co.,Ltd certifies that Model JSA-A-100s Louver shown herein is licensed to bear the AMCA Seal for Model JSA-A-100s. The ratings shown are based on tests and procedures performed in accordance with AMCA Publication 511 and comply with the requirements of the AMCA Certified Ratings Program.

The AMCA Certified Ratings Seal applies to Air Performance and Water Penetration Ratings.

Test Information

Test for Air Performance in accordance with ANSI/AMCA Standard 500-L-12(Pressure Drop), Figure 5.5.

Test sample size is 48 in X 48 in.(W1 X H1)

Air Performance

Free Area Chart(Sq.Ft.)

H" \ W"	12	18	24	30	36	42	48	54	60	66	72	78	84	90	96	102	108	114
12	4.3% 0.043	7.6% 0.113	9.2% 0.184	10.2% 0.255	10.9% 0.326	11.3% 0.396	11.7% 0.467	12.0% 0.538	12.0% 0.599	12.2% 0.670	12.3% 0.741	12.5% 0.812	12.6% 0.882	12.7% 0.953	12.8% 1.024	12.9% 1.095	12.9% 1.165	13.0% 1.236
18	8.4% 0.125	14.8% 0.334	18.1% 0.542	20.0% 0.750	21.3% 0.959	22.2% 1.167	22.9% 1.375	23.5% 1.584	23.5% 1.765	23.9% 1.973	24.2% 2.181	24.5% 2.390	24.7% 2.598	24.9% 2.806	25.1% 3.015	25.3% 3.223	25.4% 3.431	25.5% 3.640
24	10.4% 0.209	18.5% 0.555	22.5% 0.901	24.9% 1.247	26.6% 1.594	27.7% 1.940	28.6% 2.286	29.2% 2.632	29.3% 2.933	29.8% 3.279	30.2% 3.626	30.6% 3.972	30.8% 4.318	31.1% 4.664	31.3% 5.011	31.5% 5.357	31.7% 5.703	31.8% 6.049
30	14.4% 0.359	25.5% 0.955	31.0% 1.552	34.4% 2.148	36.6% 2.744	38.2% 3.340	39.4% 3.937	40.3% 4.533	40.4% 5.051	41.1% 5.647	41.6% 6.243	42.1% 6.840	42.5% 7.436	42.8% 8.032	43.1% 8.628	43.4% 9.225	43.6% 9.821	43.9% 10.417
36	14.7% 0.442	26.1% 1.176	31.8% 1.909	35.2% 2.643	37.5% 3.377	39.1% 4.111	40.4% 4.844	41.3% 5.578	41.4% 6.216	42.1% 6.949	42.7% 7.683	43.2% 8.417	43.6% 9.151	43.9% 9.884	44.2% 10.618	44.5% 11.352	44.8% 12.086	45.0% 12.819
42	15.0% 0.525	26.6% 1.397	32.4% 2.268	35.9% 3.140	38.2% 4.012	39.9% 4.883	41.1% 5.755	42.1% 6.627	42.2% 7.384	42.9% 8.256	43.5% 9.127	44.0% 9.999	44.4% 10.871	44.7% 11.742	45.1% 12.614	45.3% 13.486	45.6% 14.357	45.8% 15.229
48	15.2% 0.608	27.0% 1.618	32.8% 2.627	36.4% 3.637	38.7% 4.646	40.4% 5.656	41.7% 6.666	42.6% 7.675	42.8% 8.552	43.5% 9.562	44.0% 10.571	44.5% 11.581	45.0% 12.591	45.3% 13.600	45.7% 14.610	45.9% 15.619	46.2% 16.629	46.4% 17.639
54	15.4% 0.691	27.2% 1.838	33.2% 2.985	36.7% 4.132	39.1% 5.279	40.8% 6.426	42.1% 7.573	43.1% 8.721	43.2% 9.717	43.9% 10.864	44.5% 12.011	45.0% 13.158	45.4% 14.305	45.8% 15.453	46.1% 16.600	46.4% 17.747	46.7% 18.894	46.9% 20.041
60	15.5% 0.774	27.5% 2.059	33.4% 3.344	37.0% 4.629	39.4% 5.914	41.1% 7.199	42.4% 8.484	43.4% 9.769	43.5% 10.885	44.3% 12.170	44.9% 13.455	45.4% 14.740	45.8% 16.025	46.2% 17.310	46.5% 18.595	46.8% 19.880	47.0% 21.165	47.3% 22.450
66	15.6% 0.857	27.6% 2.280	33.7% 3.703	37.3% 5.126	39.7% 6.549	41.4% 7.972	42.7% 9.395	43.7% 10.818	43.8% 12.054	44.6% 13.477	45.2% 14.900	45.7% 16.322	46.1% 17.745	46.5% 19.168	46.8% 20.591	47.1% 22.014	47.3% 23.437	47.6% 24.860
72	15.7% 0.940	27.8% 2.501	33.8% 4.062	37.5% 5.623	39.9% 7.184	41.6% 8.744	42.9% 10.305	43.9% 11.866	44.1% 13.222	44.8% 14.783	45.4% 16.344	45.9% 17.905	46.3% 19.465	46.7% 21.026	47.1% 22.587	47.3% 24.148	47.6% 25.709	47.8% 27.270
78	15.7% 1.023	27.9% 2.721	34.0% 4.420	37.6% 6.118	40.1% 7.816	41.8% 9.515	43.1% 11.213	44.1% 12.911	44.3% 14.387	45.0% 16.085	45.6% 17.783	46.1% 19.482	46.5% 21.180	46.9% 22.878	47.3% 24.577	47.6% 26.275	47.8% 27.973	48.1% 29.672
84	15.8% 1.104	28.0% 2.938	34.1% 4.771	37.7% 6.604	40.2% 8.438	41.9% 10.271	43.2% 12.104	44.2% 13.938	44.4% 15.530	45.1% 17.364	45.7% 19.197	46.2% 21.030	46.7% 22.864	47.0% 24.697	47.4% 26.530	47.7% 28.364	47.9% 30.197	48.2% 32.030

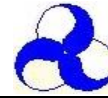

Stationary and Adjustable Louvers

JSA-A-100s



Jaesung Aluminum Co.,Ltd certifies that Model JSA-A-100s Louver shown herein is licensed to bear the AMCA Seal for Model JSA-A-100s. The ratings shown are based on tests and procedures performed in accordance with AMCA Publication 511 and comply with the requirements of the AMCA Certified Ratings Program.

The AMCA Certified Ratings Seal applies to Air Performance and Water Penetration Ratings.

Test Information

Test for water penetration in accordance with ANSI/AMCA Standard 500-L-07, Figure 5.6.

Test sample size is 48 in X 48 in.(W1 X H1). Test Period 15 minutes. Data at standard air density.

Water Penetration

JSA-A-100s

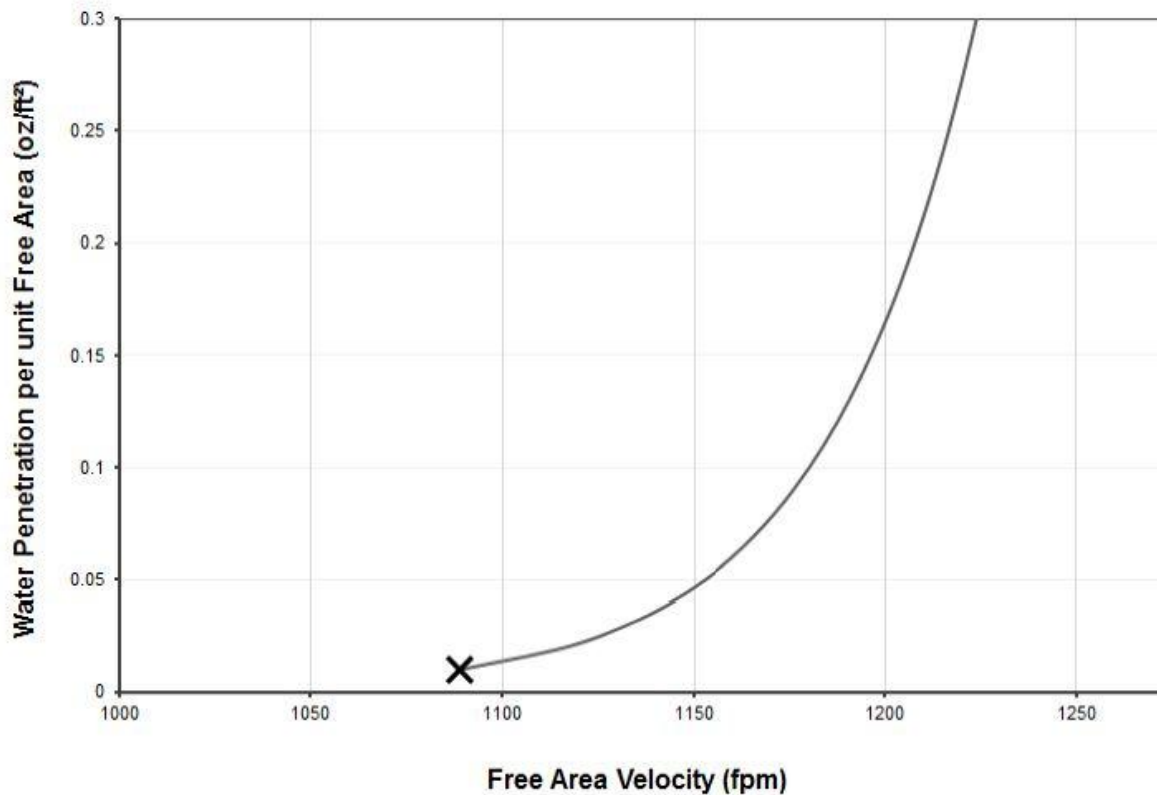

— Water Penetration per Free Area x Beginning of Water Penetration

The beginning point of water penetration for Model JSA-A-100s is 1086 fpm free area velocity.

Construction - Dimension and details

- | | | |
|-----------------|-------------------|-----------------------|
| 1. UPP-FRAME | 5. FIXED BLAED | 9. SCREEN SUPPORT BAR |
| 2. LOW-FRAME | 6. SCREEN BAR | 10. LOW-BAFFLE |
| 3. SIDE FRAME | 7. SIDE BAFFLE | 11. BIRD SCREEN |
| 4. SIDE FRAME-1 | 8. SCREEN SUPPORT | |

Vertical Section

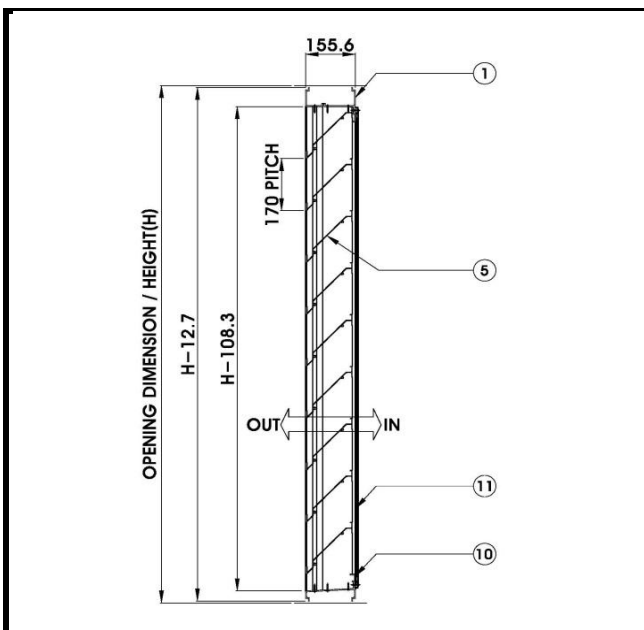

Horizontal Section

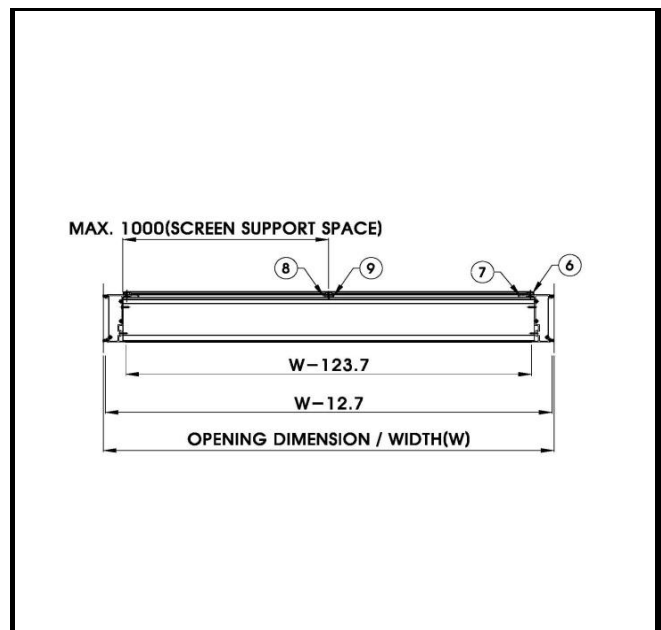

Louver Front View

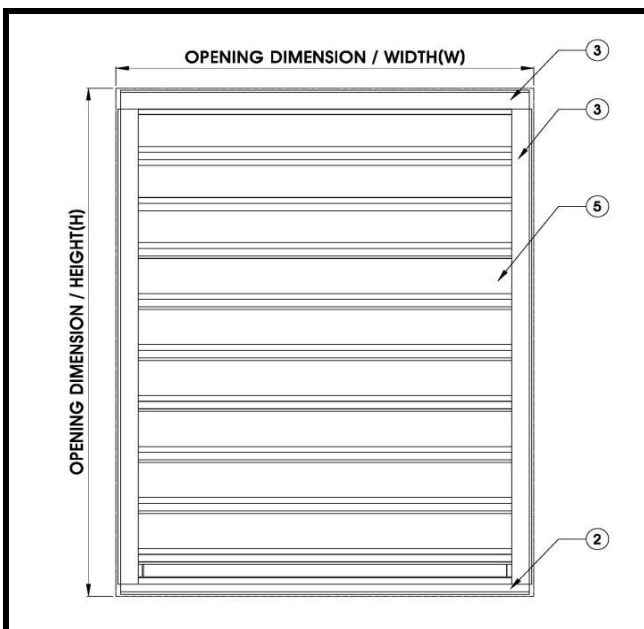

Mullion of Multiple Module

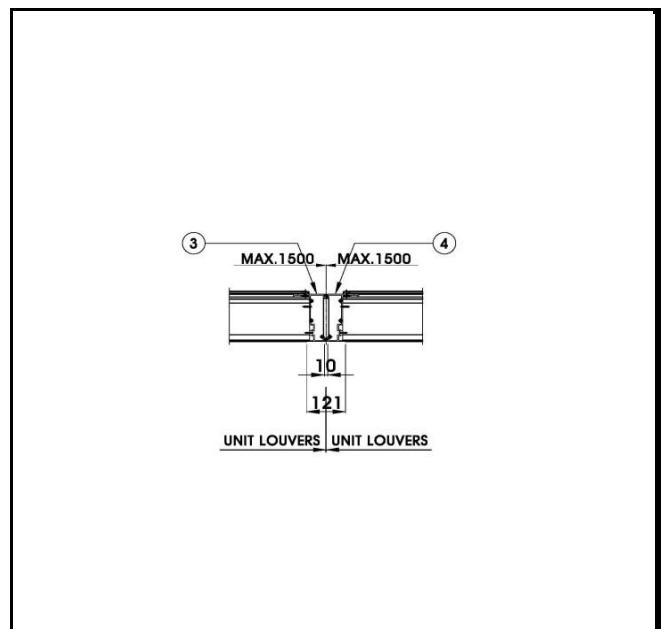

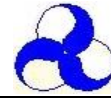

Stationary and Adjustable Louvers

JSA-A'-100s



Jaesung Aluminum Co.,Ltd certifies that Model JSA-A'-100s Louver shown herein is licensed to bear the AMCA Seal for Model JSA-A'-100s. The ratings shown are based on tests and procedures performed in accordance with AMCA Publication 511 and comply with the requirements of the AMCA Certified Ratings Program.

The AMCA Certified Ratings Seal applies to Air Performance and Water Penetration Ratings.

Test Information

Test for air performance in accordance with ANSI/AMCA Standard 500-L-12(Pressure Drop), Figure 5.5.

Test for water penetration in accordance with ANSI/AMCA Standard 500-L-07, Figure 5.6.

Construction Standard

FRAME:

Gauge 15(2.0mm thick) formed extruded aluminum profiles.(A6063-T5)

BLADES:

Gauge 15(2.0mm thick) formed extruded aluminum profiles.(A6063-T5)

SCREEN:

Stainless steel bird screen 1/2"~3/4"(12~19) fixed in front or behind the blades.

Please note that Pressure Drop Data is obtained from Test without bird screen.

Pressure drop of bird screen is additive and to be calculated separately.

MINIMUM SIZE:

300 X 300mm(12in X 12in) - Neck Size

MAXIMUM SIZE:

2100 X 2900mm as single section(Neck Size)
2 section more module consult JAS for multiple section assembly details.

Catalog ID : JSA-A'-100 July 2016

JSA-A'-100s



Optional Extras

***Code A**

Finished to Anodizing.

***Code P**

Painted to PVDF.

***Code I**

Insect screen in aluminum.

***Code B**

Bird screen in stainless steel.



Stationary and Adjustable Louvers

JSA-A'-100s



Jaesung Aluminum Co.,Ltd certifies that Model JSA-A'-100s Louver shown herein is licensed to bear the AMCA Seal for Model JSA-A'-100s. The ratings shown are based on tests and procedures performed in accordance with AMCA Publication 511 and comply with the requirements of the AMCA Certified Ratings Program.

The AMCA Certified Ratings Seal applies to Air Performance and Water Penetration Ratings.

Test Information

Test for Air Performance in accordance with ANSI/AMCA Standard 500-L-12(Pressure Drop), Figure 5.5.

Test sample size is 48 in X 48 in.(W1 X H1). Data at standard air density.

Air Performance

Pressure Drop

Intake Air Performance

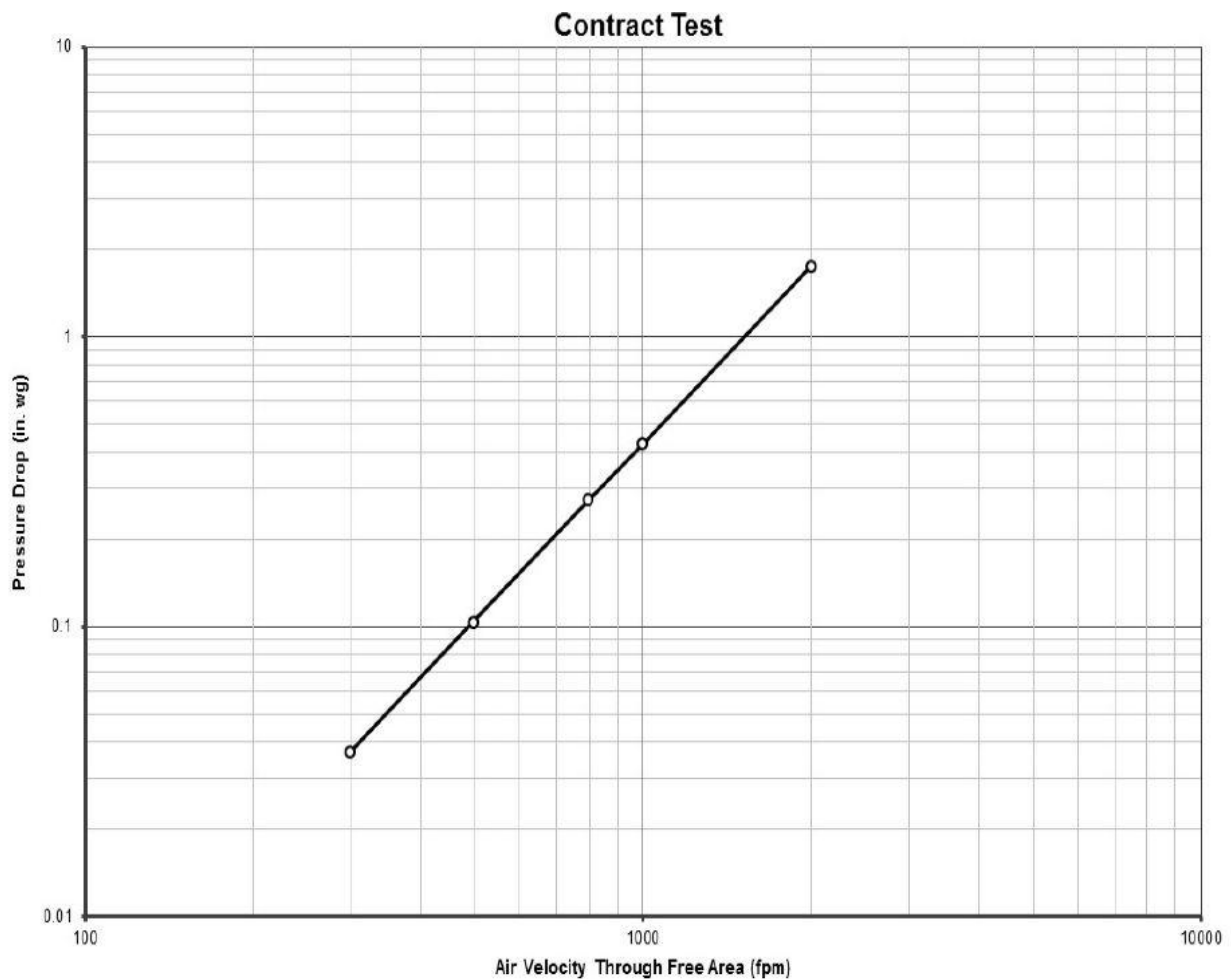

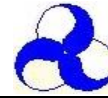

Stationary and Adjustable Louvers

JSA-A'-100s



Jaesung Aluminum Co.,Ltd certifies that Model JSA-A'-100s Louver shown herein is licensed to bear the AMCA Seal for Model JSA-A'-100s. The ratings shown are based on tests and procedures performed in accordance with AMCA Publication 511 and comply with the requirements of the AMCA Certified Ratings Program.

The AMCA Certified Ratings Seal applies to Air Performance and Water Penetration Ratings.

Test Information

Test for Air Performance in accordance with ANSI/AMCA Standard 500-L-12(Pressure Drop), Figure 5.5.

Test sample size is 48 in X 48 in.(W1 X H1)

Air Performance

Free Area Chart(Sq.Ft.)

H" \ W"	12	18	24	30	36	42	48	54	60	66	72	78	84	90	96	102	108	114
12	15.9%	20.0%	22.0%	23.2%	24.0%	24.6%	25.0%	25.4%	25.3%	25.5%	25.7%	25.9%	26.1%	26.2%	26.3%	26.4%	26.5%	26.6%
	0.159	0.299	0.440	0.580	0.720	0.861	1.001	1.141	1.263	1.403	1.544	1.684	1.824	1.964	2.105	2.245	2.385	2.526
18	21.2%	26.6%	29.3%	30.9%	32.0%	32.8%	33.4%	33.8%	33.7%	34.0%	34.3%	34.5%	34.7%	34.9%	35.1%	35.2%	35.3%	35.4%
	0.318	0.599	0.879	1.160	1.440	1.721	2.002	2.282	2.526	2.807	3.087	3.368	3.648	3.929	4.209	4.490	4.771	5.051
24	24.9%	31.3%	34.4%	36.3%	37.6%	38.5%	39.2%	39.7%	39.6%	40.0%	40.3%	40.6%	40.8%	41.0%	41.2%	41.4%	41.5%	41.7%
	0.498	0.938	1.378	1.817	2.257	2.697	3.136	3.576	3.958	4.397	4.837	5.277	5.716	6.156	6.596	7.035	7.475	7.914
30	27.1%	34.0%	37.4%	39.5%	40.9%	41.9%	42.6%	43.2%	43.0%	43.4%	43.8%	44.1%	44.4%	44.6%	44.8%	45.0%	45.1%	45.3%
	0.677	1.274	1.871	2.468	3.065	3.662	4.259	4.856	5.375	5.972	6.569	7.166	7.763	8.360	8.957	9.554	10.151	10.748
36	28.5%	35.8%	39.4%	41.6%	43.0%	44.1%	44.8%	45.5%	45.3%	45.7%	46.1%	46.4%	46.7%	46.9%	47.2%	47.3%	47.5%	47.7%
	0.855	1.610	2.364	3.118	3.873	4.627	5.382	6.136	6.791	7.546	8.300	9.054	9.809	10.563	11.318	12.072	12.826	13.581
42	29.5%	37.1%	40.8%	43.1%	44.6%	45.7%	46.5%	47.1%	46.9%	47.4%	47.8%	48.1%	48.4%	48.6%	48.9%	49.1%	49.2%	49.4%
	1.034	1.946	2.858	3.770	4.682	5.593	6.505	7.417	8.209	9.121	10.033	10.945	11.857	12.769	13.681	14.593	15.505	16.417
48	29.8%	37.4%	41.2%	43.5%	45.0%	46.1%	46.9%	47.5%	47.4%	47.8%	48.2%	48.6%	48.9%	49.1%	49.3%	49.5%	49.7%	49.8%
	1.193	2.245	3.297	4.350	5.402	6.454	7.506	8.558	9.472	10.525	11.577	12.629	13.681	14.733	15.786	16.838	17.890	18.942
54	30.0%	37.7%	41.5%	43.8%	45.3%	46.4%	47.3%	47.9%	47.7%	48.2%	48.6%	48.9%	49.2%	49.5%	49.7%	49.9%	50.1%	50.2%
	1.352	2.545	3.737	4.930	6.122	7.314	8.507	9.699	10.735	11.928	13.120	14.313	15.505	16.698	17.890	19.083	20.275	21.468
60	30.3%	38.0%	41.9%	44.2%	45.8%	46.9%	47.7%	48.3%	48.2%	48.6%	49.0%	49.4%	49.7%	49.9%	50.2%	50.4%	50.5%	50.7%
	1.516	2.854	4.191	5.528	6.866	8.203	9.540	10.878	12.040	13.377	14.714	16.052	17.389	18.726	20.064	21.401	22.739	24.076
66	30.8%	38.7%	42.6%	44.9%	46.5%	47.6%	48.5%	49.1%	48.9%	49.4%	49.8%	50.2%	50.5%	50.7%	51.0%	51.2%	51.3%	51.5%
	1.695	3.190	4.684	6.179	7.674	9.168	10.663	12.158	13.456	14.951	16.446	17.941	19.435	20.930	22.425	23.920	25.414	26.909
72	31.2%	39.2%	43.1%	45.5%	47.1%	48.3%	49.1%	49.8%	49.6%	50.1%	50.5%	50.8%	51.1%	51.4%	51.6%	51.8%	52.0%	52.2%
	1.873	3.525	5.177	6.830	8.482	10.134	11.786	13.438	14.873	16.525	18.177	19.830	21.482	23.134	24.786	26.438	28.090	29.742
78	31.6%	39.6%	43.6%	46.0%	47.6%	48.8%	49.6%	50.3%	50.1%	50.6%	51.0%	51.4%	51.7%	52.0%	52.2%	52.4%	52.6%	52.8%
	2.052	3.861	5.671	7.480	9.290	11.099	12.909	14.718	16.290	18.100	19.909	21.718	23.528	25.337	27.147	28.956	30.766	32.575
84	31.8%	39.9%	44.0%	46.4%	48.0%	49.2%	50.0%	50.7%	50.5%	51.0%	51.5%	51.8%	52.1%	52.4%	52.6%	52.8%	53.0%	53.2%
	2.227	4.191	6.155	8.119	10.083	12.047	14.011	15.976	17.682	19.646	21.610	23.574	25.538	27.502	29.466	31.430	33.395	35.359

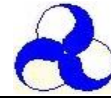

Stationary and Adjustable Louvers

JSA-A'-100s



Jaesung Aluminum Co.,Ltd certifies that Model JSA-A'-100s Louver shown herein is licensed to bear the AMCA Seal for Model JSA-A'-100s. The ratings shown are based on tests and procedures performed in accordance with AMCA Publication 511 and comply with the requirements of the AMCA Certified Ratings Program.

The AMCA Certified Ratings Seal applies to Air Performance and Water Penetration Ratings.

Test Information

Test for water penetration in accordance with ANSI/AMCA Standard 500-L-07, Figure 5.6.

Test sample size is 48 in X 48 in.(W1 X H1). Test Period 15 minutes. Data at standard air density.

Water Penetration

JSA-A'-100s

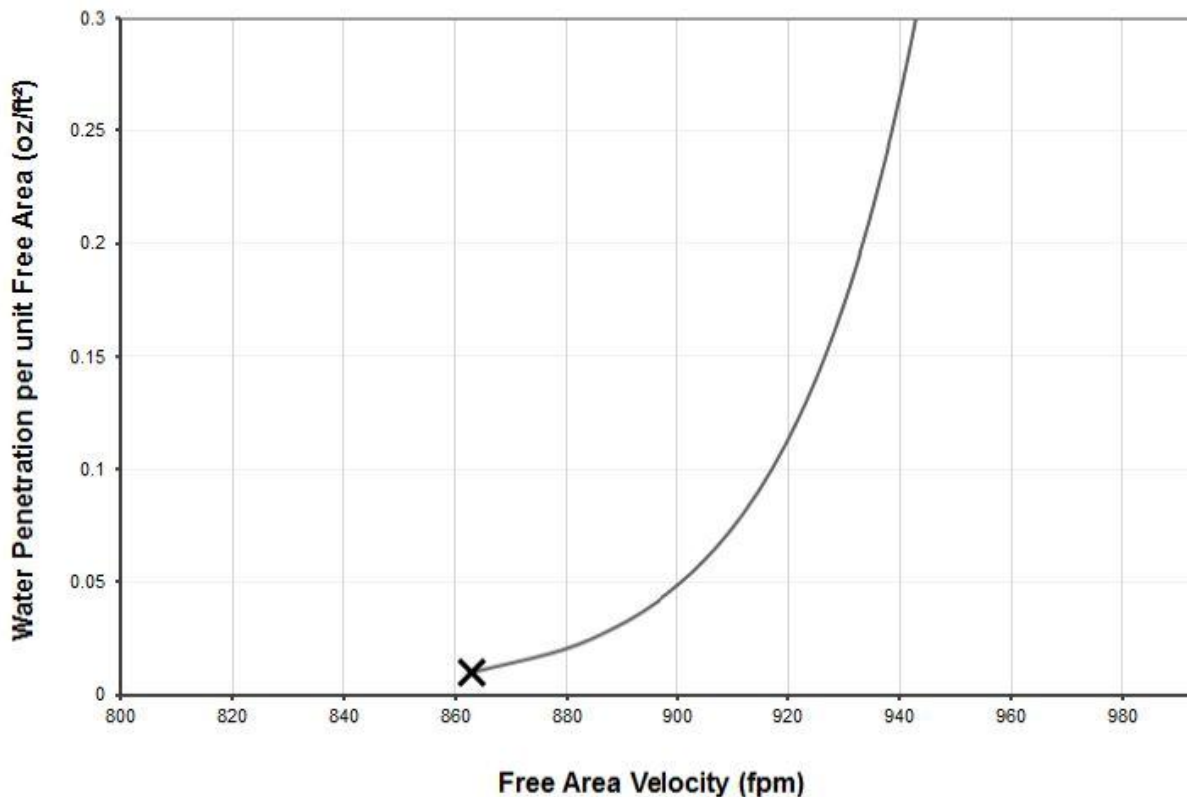

— Water Penetration per Free Area x Beginning of Water Penetration

The beginning point of water penetration for Model JSA-A'-100s is 864.3 fpm free area velocity.

Construction - Dimension and details

1. UPP-FRAME
2. LOW-FRAME
3. SIDE FRAME
4. FIXDE BLAED

Vertical Section

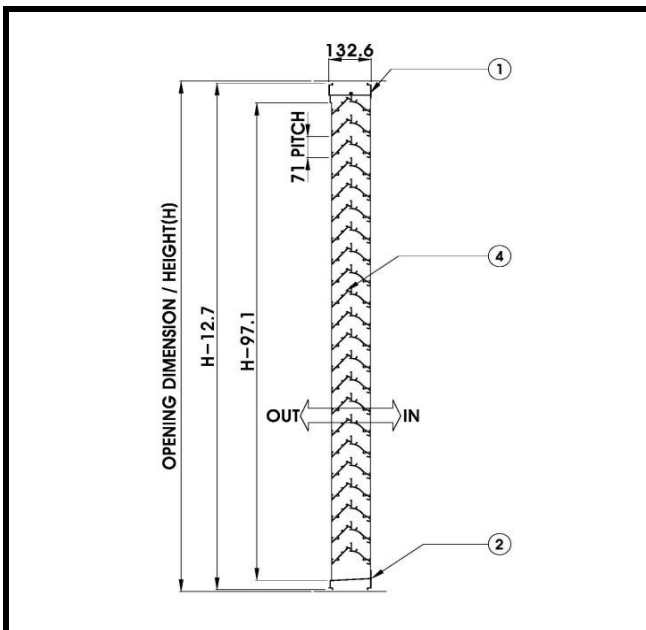

Horizontal Section

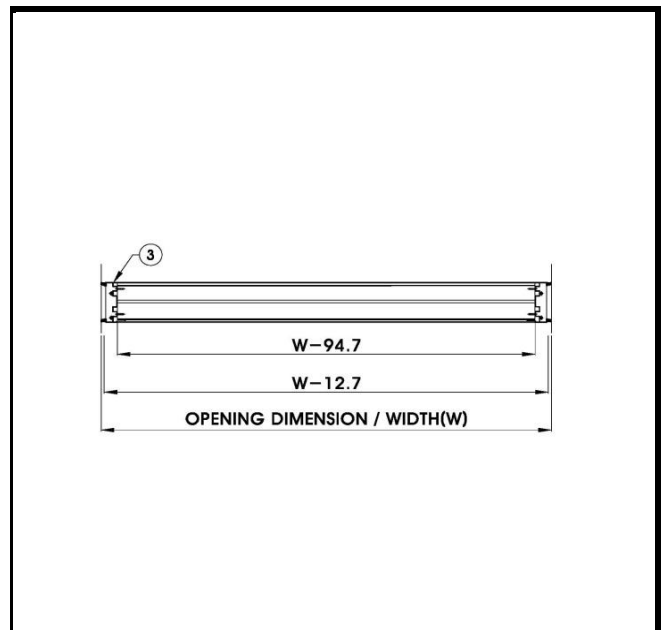

Louver Front View

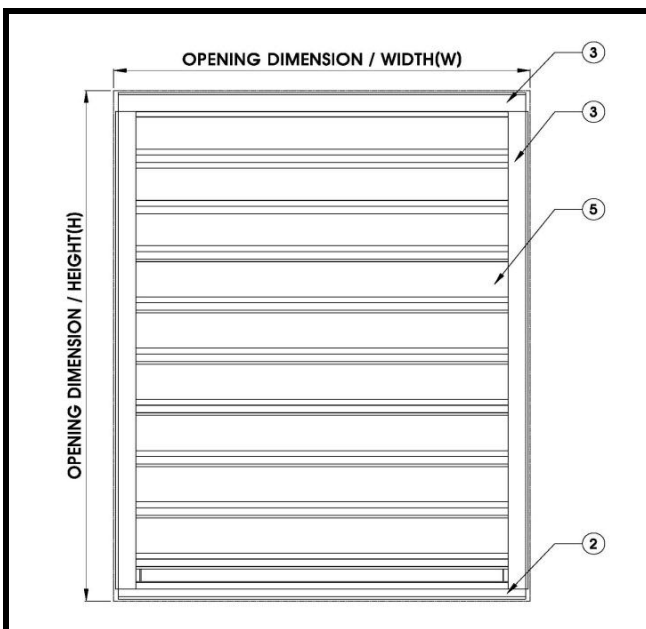

Mullion of Multiple Module

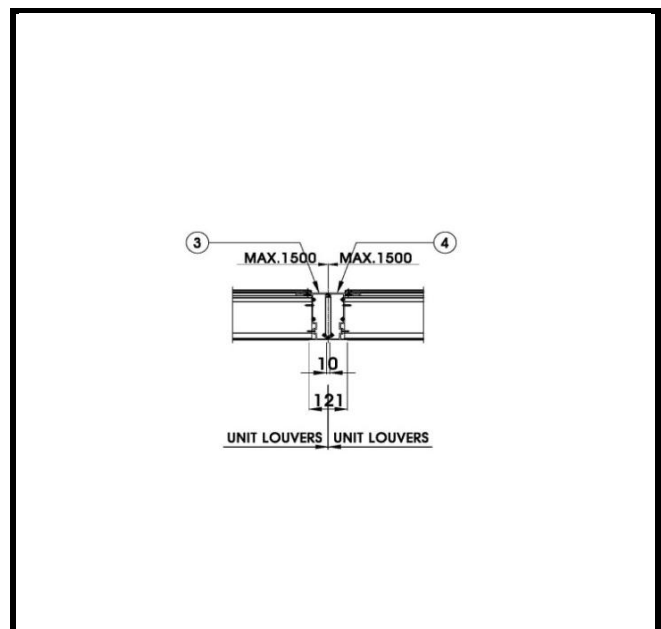



Stationary and Adjustable Louvers

JSA-C-100s



Jaesung Aluminum Co.,Ltd certifies that Model JSA-C-100s Louver shown herein is licensed to bear the AMCA Seal for Model JSA-C-100s. The ratings shown are based on tests and procedures performed in accordance with AMCA Publication 511 and comply with the requirements of the AMCA Certified Ratings Program.

The AMCA Certified Ratings Seal applies to Air Performance and Water Penetration and Air Leakage Ratings.

Test Information

Test for Air Performance in accordance with ANSI/AMCA Standard 500-L-12(Pressure Drop), Figure 5.5.

Test for water penetration in accordance with ANSI/AMCA Standard 500-L-07, Figure 5.6.

Construction Standard

FRAME:

Gauge 12(3.2mm thick) formed extruded aluminum profiles.(A6063-T5)

BLADES:

Gauge 15(2.0mm thick) formed extruded aluminum profiles.(A6063-T5)

SCREEN:

Stainless steel bird screen 1/2"~3/4"(12~19) fixed in front or behind the blades.

Please note that Pressure Drop Data is obtained from Test without bird screen.

Pressure drop of bird screen is additive and to be calculated separately.

MINIMUM SIZE:

300 X 300mm(12in X 12in) - Neck Size

MAXIMUM SIZE:

2100 X 2900mm as single section(Neck Size)
2 section more module consult JAS for multiple section assembly details.

Catalog ID : JSA-C-100 July 2016

JSA-C-100s



Optional Extras

*Code A

Finished to Anodizing.

*Code P

Painted to PVDF.

*Code I

Insect screen in aluminum.

*Code B

Bird screen in stainless steel.

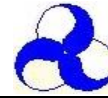

Stationary and Adjustable Louvers

JSA-C-100s

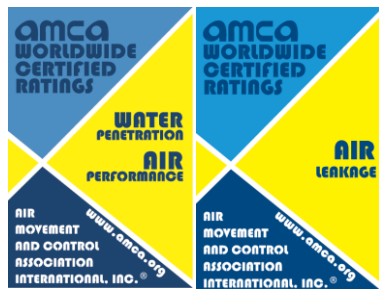

Jaesung Aluminum Co.,Ltd certifies that Model JSA-C-100s Louver shown herein is licensed to bear the AMCA Seal for Model JSA-C-100s. The ratings shown are based on tests and procedures performed in accordance with AMCA Publication 511 and comply with the requirements of the AMCA Certified Ratings Program.

The AMCA Certified Ratings Seal applies to Air Performance and Water Penetration and Air Leakage Ratings.

Test Information

Test for Air Performance in accordance with ANSI/AMCA Standard 500-L-12(Pressure Drop), Figure 5.5.

Test sample size is 48 in X 48 in.(W1 X H1). Data at standard air density.

Air Performance

Pressure Drop

Intake Air Performance

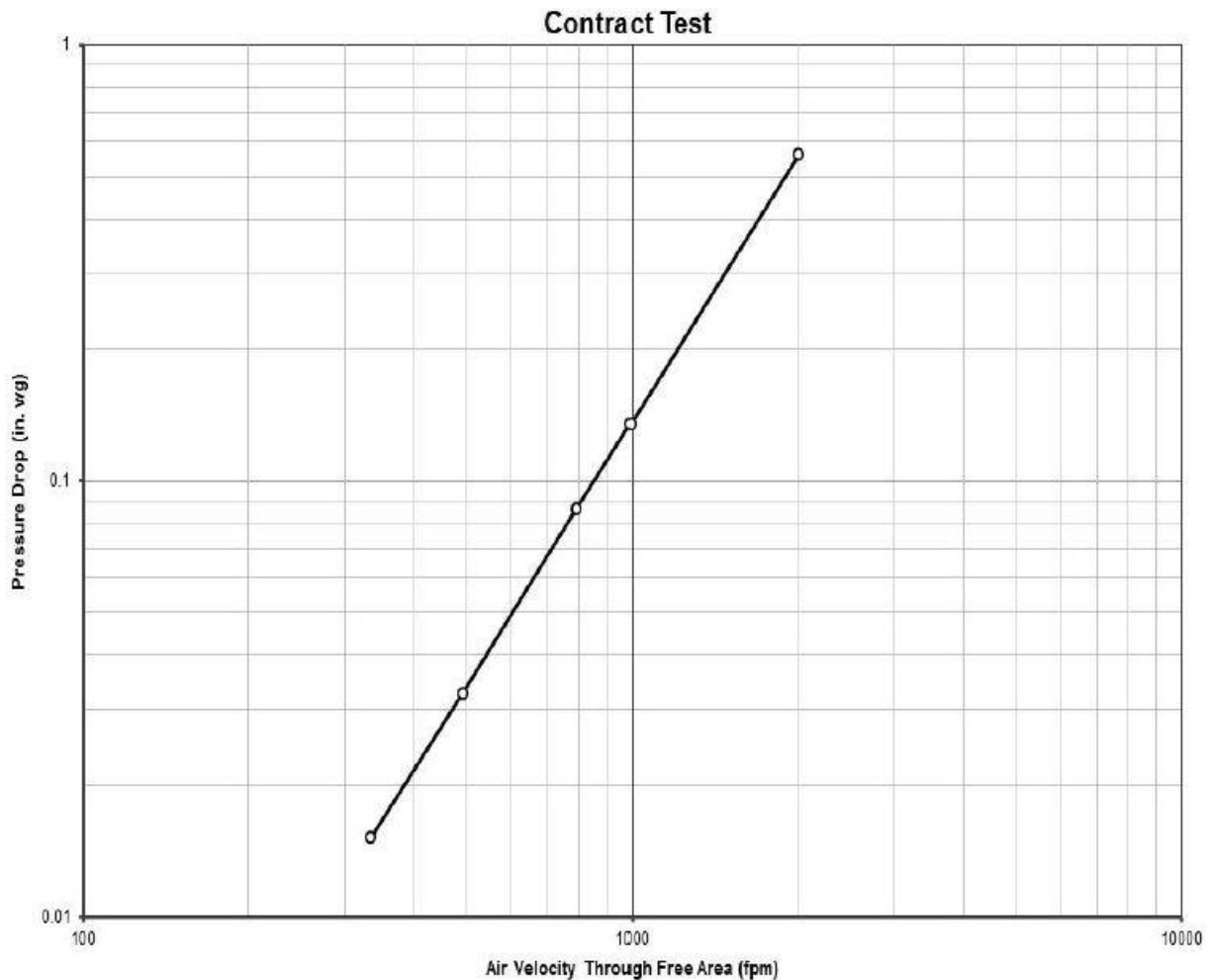

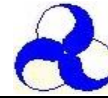

Stationary and Adjustable Louvers

JSA-C-100s



Jaesung Aluminum Co.,Ltd certifies that Model JSA-C-100s Louver shown herein is licensed to bear the AMCA Seal for Model JSA-C-100s. The ratings shown are based on tests and procedures performed in accordance with AMCA Publication 511 and comply with the requirements of the AMCA Certified Ratings Program.

The AMCA Certified Ratings Seal applies to Air Performance and Water Penetration and Air Leakage Ratings.

Test Information

Test for Air Performance in accordance with ANSI/AMCA Standard 500-L-12(Pressure Drop), Figure 5.5.

Test sample size is 48 in X 48 in.(W1 X H1).

Air Performance

Free Area Chart(Sq.Ft.)

H" \ W"	12	18	24	30	36	42	48	54	60	66	72	78	84	90	96	102	108	114
12	4.3%	7.6%	9.2%	10.2%	10.9%	11.3%	11.7%	12.0%	12.0%	12.2%	12.3%	12.5%	12.6%	12.7%	12.8%	12.9%	12.9%	13.0%
	0.043	0.113	0.184	0.255	0.326	0.396	0.467	0.538	0.599	0.670	0.741	0.812	0.882	0.953	1.024	1.095	1.165	1.236
18	1.7%	3.0%	3.6%	4.0%	4.3%	4.4%	4.6%	4.7%	4.7%	4.8%	4.8%	4.9%	4.9%	5.0%	5.0%	5.1%	5.1%	5.1%
	0.025	0.067	0.108	0.150	0.192	0.233	0.275	0.317	0.353	0.395	0.436	0.478	0.520	0.561	0.603	0.645	0.686	0.728
24	10.0%	17.8%	21.7%	24.0%	25.6%	26.7%	27.5%	28.1%	28.2%	28.7%	29.1%	29.4%	29.7%	29.9%	30.1%	30.3%	30.5%	30.6%
	0.201	0.534	0.867	1.200	1.534	1.867	2.200	2.533	2.823	3.156	3.489	3.823	4.156	4.489	4.822	5.155	5.489	5.822
30	14.1%	24.9%	30.4%	33.6%	35.8%	37.3%	38.5%	39.4%	39.5%	40.2%	40.7%	41.2%	41.6%	41.9%	42.2%	42.5%	42.7%	42.9%
	0.351	0.935	1.518	2.101	2.684	3.267	3.851	4.434	4.941	5.524	6.107	6.690	7.274	7.857	8.440	9.023	9.606	10.190
36	14.4%	25.5%	31.0%	34.4%	36.6%	38.2%	39.4%	40.3%	40.4%	41.1%	41.6%	42.1%	42.5%	42.8%	43.1%	43.4%	43.6%	43.9%
	0.431	1.147	1.862	2.578	3.293	4.009	4.724	5.440	6.061	6.777	7.492	8.208	8.923	9.639	10.354	11.070	11.785	12.501
42	14.6%	25.9%	31.5%	34.9%	37.2%	38.8%	40.0%	40.9%	41.1%	41.7%	42.3%	42.8%	43.2%	43.5%	43.8%	44.1%	44.4%	44.6%
	0.511	1.359	2.207	3.056	3.904	4.752	5.600	6.449	7.185	8.034	8.882	9.730	10.578	11.427	12.275	13.123	13.971	14.820
48	14.8%	26.2%	31.9%	35.3%	37.6%	39.3%	40.5%	41.4%	41.5%	42.2%	42.8%	43.3%	43.7%	44.0%	44.4%	44.6%	44.9%	45.1%
	0.591	1.572	2.553	3.534	4.515	5.496	6.477	7.457	8.310	9.291	10.272	11.252	12.233	13.214	14.195	15.176	16.157	17.138
54	14.9%	26.4%	32.2%	35.6%	38.0%	39.6%	40.8%	41.8%	41.9%	42.6%	43.2%	43.7%	44.1%	44.4%	44.7%	45.0%	45.3%	45.5%
	0.671	1.784	2.897	4.010	5.123	6.237	7.350	8.463	9.430	10.544	11.657	12.770	13.883	14.996	16.110	17.223	18.336	19.449
60	15.0%	26.6%	32.4%	35.9%	38.2%	39.9%	41.1%	42.1%	42.2%	42.9%	43.5%	44.0%	44.4%	44.8%	45.1%	45.4%	45.6%	45.8%
	0.751	1.996	3.242	4.488	5.734	6.980	8.226	9.472	10.554	11.800	13.046	14.292	15.538	16.784	18.030	19.276	20.522	21.768
66	15.1%	26.8%	32.6%	36.1%	38.5%	40.1%	41.4%	42.3%	42.5%	43.2%	43.7%	44.2%	44.7%	45.0%	45.3%	45.6%	45.9%	46.1%
	0.830	2.209	3.588	4.966	6.345	7.724	9.102	10.481	11.679	13.057	14.436	15.815	17.193	18.572	19.951	21.329	22.708	24.086
72	15.2%	26.9%	32.8%	36.3%	38.6%	40.3%	41.6%	42.6%	42.7%	43.4%	44.0%	44.5%	44.9%	45.2%	45.6%	45.8%	46.1%	46.3%
	0.910	2.422	3.933	5.444	6.956	8.467	9.979	11.490	12.803	14.314	15.826	17.337	18.848	20.360	21.871	23.382	24.894	26.405
78	15.2%	27.0%	32.9%	36.4%	38.8%	40.5%	41.7%	42.7%	42.8%	43.5%	44.1%	44.6%	45.1%	45.4%	45.7%	46.0%	46.3%	46.5%
	0.990	2.634	4.277	5.921	7.565	9.208	10.852	12.496	13.924	15.567	17.211	18.854	20.498	22.142	23.785	25.429	27.073	28.716
84	15.3%	27.1%	33.0%	36.5%	38.9%	40.6%	41.8%	42.8%	42.9%	43.6%	44.2%	44.7%	45.1%	45.5%	45.8%	46.1%	46.4%	46.6%
	1.068	2.842	4.615	6.389	8.162	9.935	11.709	13.482	15.023	16.796	18.570	20.343	22.117	23.890	25.664	27.437	29.211	30.984

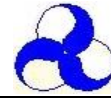

Stationary and Adjustable Louvers

JSA-C-100s

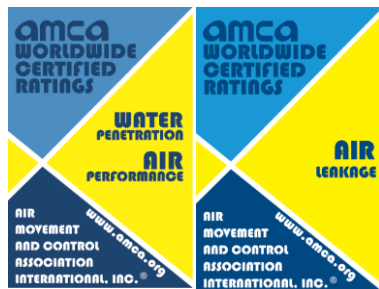

Jaesung Aluminum Co.,Ltd certifies that Model JSA-C-100s Louver shown herein is licensed to bear the AMCA Seal for Model JSA-C-100s. The ratings shown are based on tests and procedures performed in accordance with AMCA Publication 511 and comply with the requirements of the AMCA Certified Ratings Program.

The AMCA Certified Ratings Seal applies to Air Performance and Water Penetration and Air Leakage Ratings.

Test Information

Test sample size is 48 in X 48 in.(W1 X H1). Test Period 15 minutes. Data at standard air density.

Water Penetration

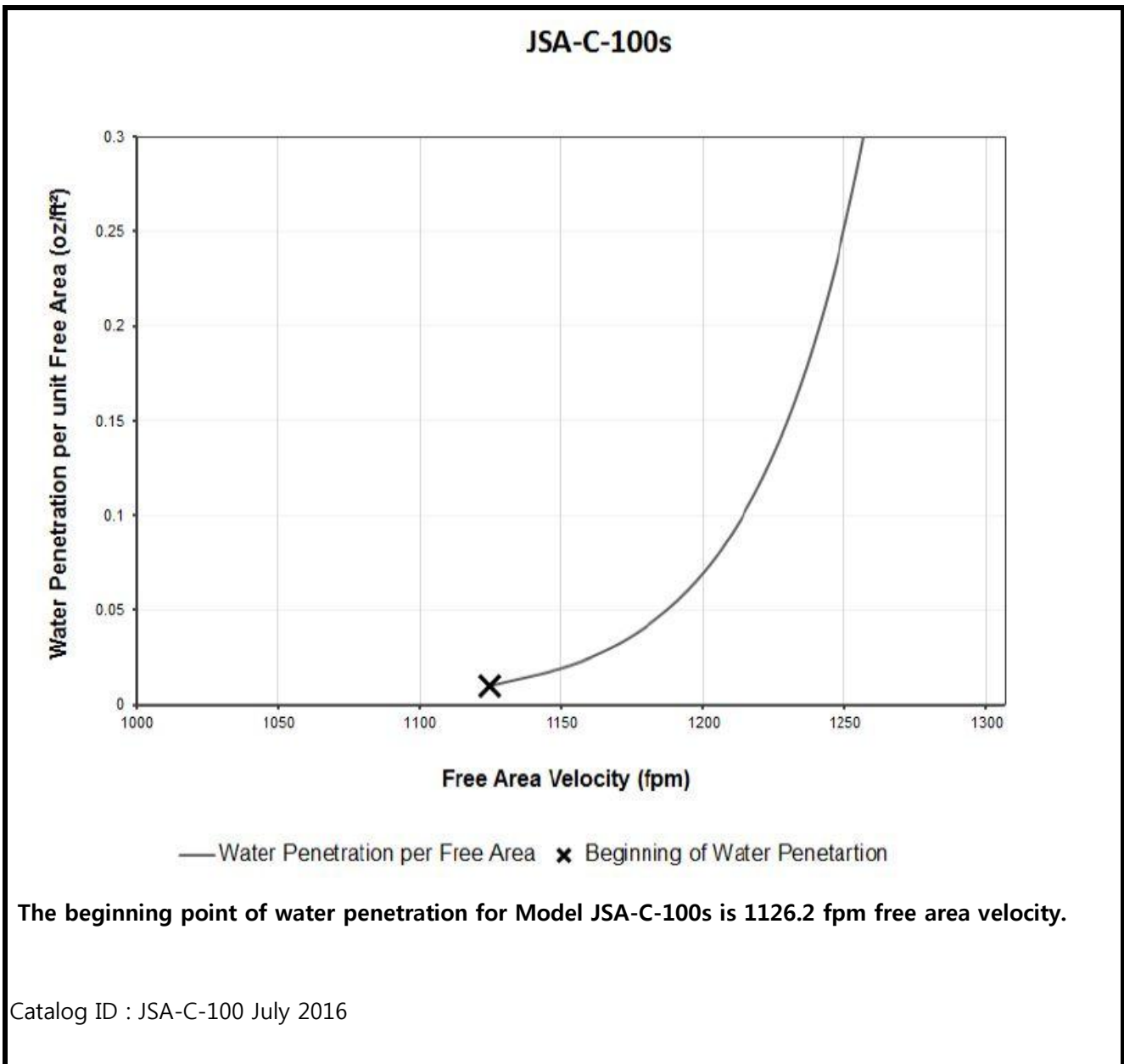

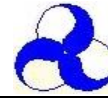

Stationary and Adjustable Louvers

JSA-C-100s



Jaesung Aluminum Co.,Ltd certifies that Model JSA-C-100s Louver shown herein is licensed to bear the AMCA Seal for Model JSA-C-100s. The ratings shown are based on tests and procedures performed in accordance with AMCA Publication 511 and comply with the requirements of the AMCA Certified Ratings Program. The AMCA Certified Ratings Seal applies to Air Performance and Water Penetration and Air Leakage Ratings.

Test Information

Test Figure 5.4. Test sample size is 48 in X 48 in. Data at standard air density. Air leakage is based on operation between 10°C – 40°C. Data are based on a torque of 5.7 in.-lb/ft² applied to close and seat the damper during the test.

Air Leakage

Intake Leakage

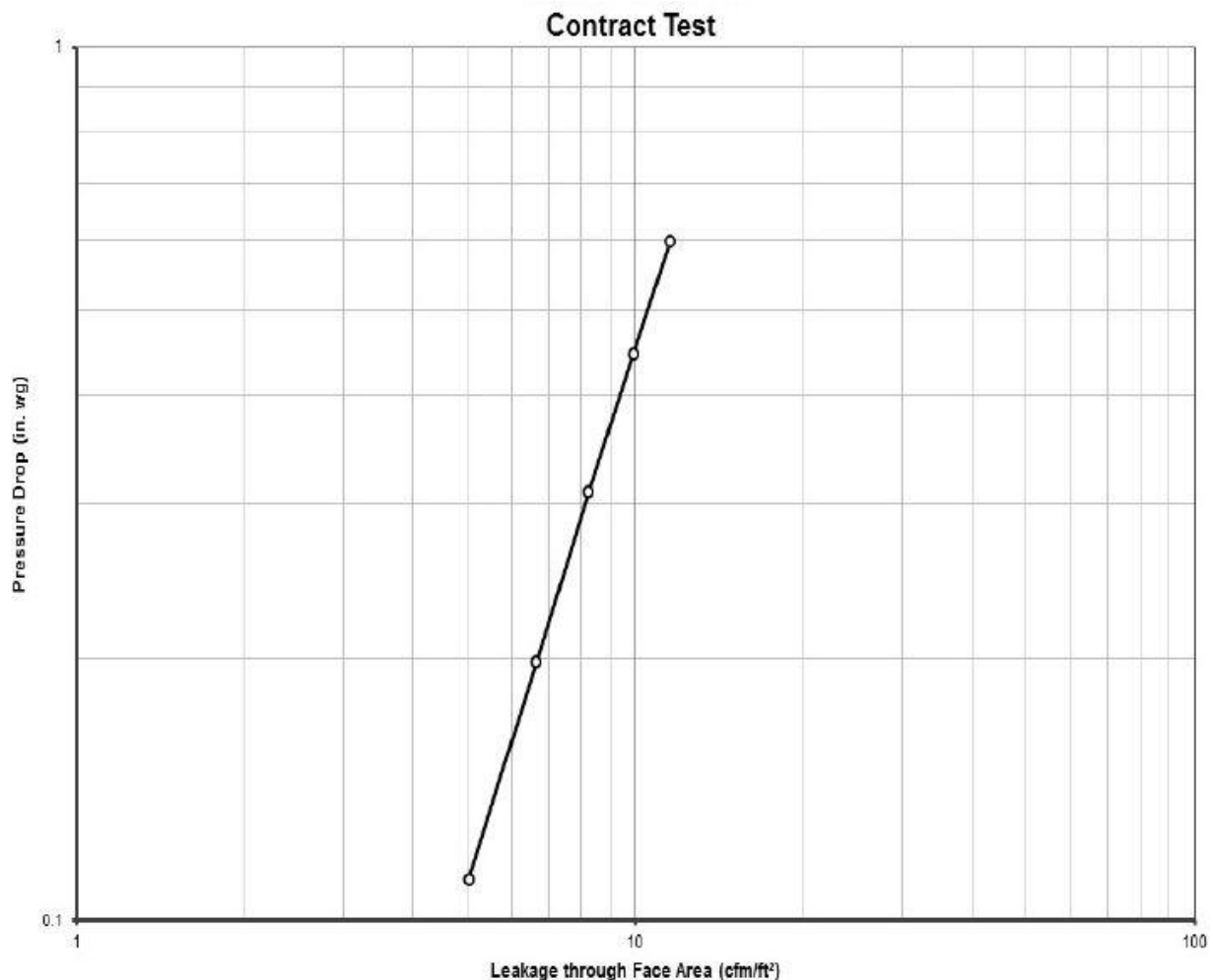

Construction - Dimension and details

1. UPP-FRAME	5. FIXED BLAED	9. SCREEN SUPPORT BAR	13. BLADE SEAL
2. LOW-FRAME	6. SCREEN BAR	10. LOW-BAFFLE	14. SHAFT 15. BUSHING
3. SIDE FRAME	7. SIDE BAFFLE	11. BIRD SCREEN	16. LINK ARM 17. LINKAGE
4. SIDE FRAME-1	8. SCREEN SUPPORT	12. OPERATING BLADE	18. HANDEL

Vertical Section

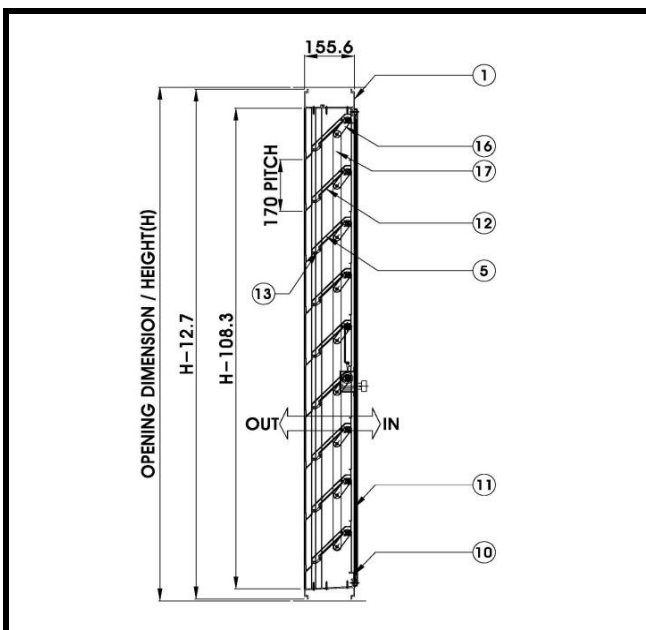

Horizontal Section

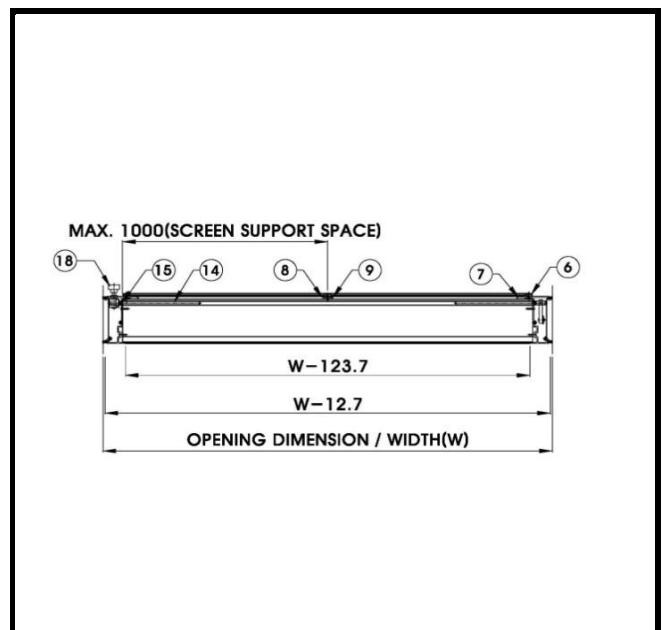

Louver Front View

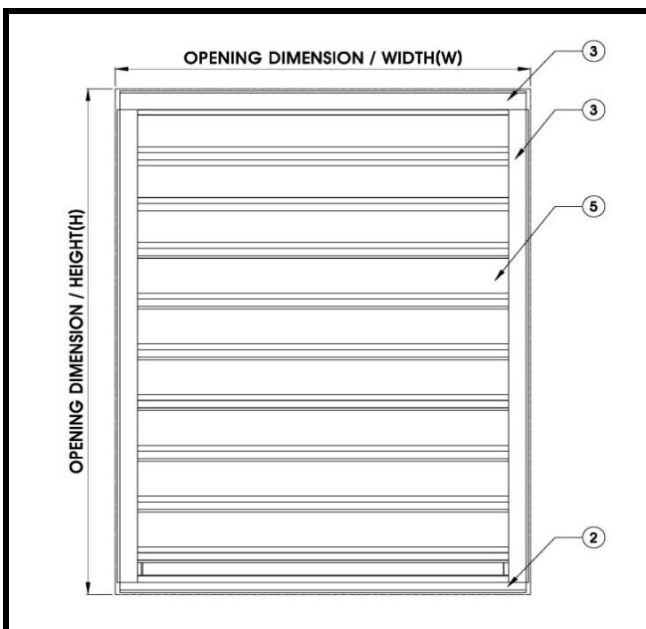

Mullion of Multiple Module

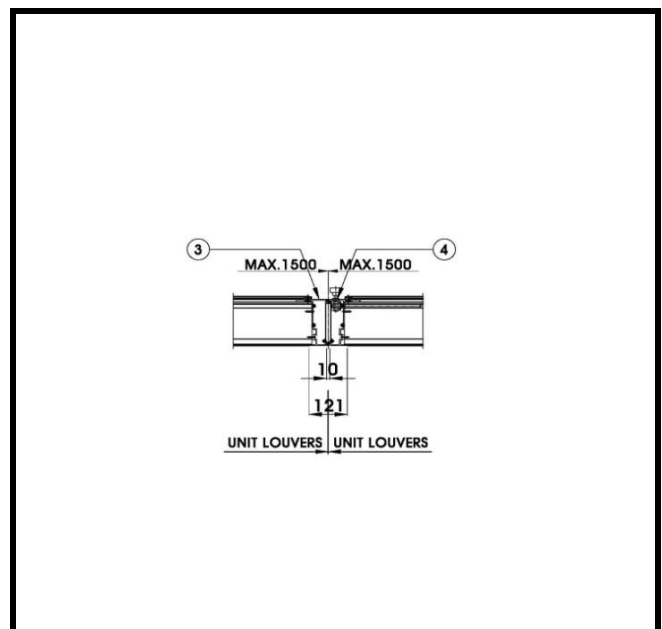

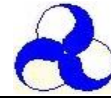

Stationary and Adjustable Louvers

JSA-D-100s



Jaesung Aluminum Co.,Ltd certifies that Model JSA-D-100s Louver shown herein is licensed to bear the AMCA Seal for Model JSA-D-100s. The ratings shown are based on tests and procedures performed in accordance with AMCA Publication 511 and comply with the requirements of the AMCA Certified Ratings Program.

The AMCA Certified Ratings Seal applies to Air Performance and Water Penetration Ratings.

Test Information

Test for air performance in accordance with ANSI/AMCA Standard 500-L-12(Pressure Drop), Figure 5.5.

Test for water penetration in accordance with ANSI/AMCA Standard 500-L-07, Figure 5.6.

Construction Standard

FRAME:

Gauge 12(3.2mm thick) formed extruded aluminum profiles.(A6063-T5)

BLADES:

Gauge 15(2.0mm thick) formed extruded aluminum profiles.(A6063-T5)

SCREEN:

Stainless steel bird screen 1/2"~3/4"(12~19) fixed in front or behind the blades.

Please note that Pressure Drop Data is obtained from Test without bird screen.

Pressure drop of bird screen is additive and to be calculated separately.

MINIMUM SIZE:

300 X 300mm(12in X 12in) - Neck Size

MAXIMUM SIZE:

2100 X 2900mm as single section(Neck Size)
2 section more module consult JAS for multiple section assembly details.

Catalog ID : JSA-D-100 July 2016

JSA-D-100s



Optional Extras

***Code A**

Finished to Anodizing.

***Code P**

Painted to PVDF.

***Code I**

Insect screen in aluminum.

***Code B**

Bird screen in stainless steel.



Stationary and Adjustable Louvers

JSA-D-100s



Jaesung Aluminum Co.,Ltd certifies that Model JSA-D-100s Louver shown herein is licensed to bear the AMCA Seal for Model JSA-D-100s. The ratings shown are based on tests and procedures performed in accordance with AMCA Publication 511 and comply with the requirements of the AMCA Certified Ratings Program.

The AMCA Certified Ratings Seal applies to Air Performance and Water Penetration Ratings.

Test Information

Test for Air Performance in accordance with ANSI/AMCA Standard 500-L-12(Pressure Drop), Figure 5.5.

Test sample size is 48 in X 48 in.(W1 X H1). Data at standard air density.

Air Performance

Pressure Drop

Intake Air Performance

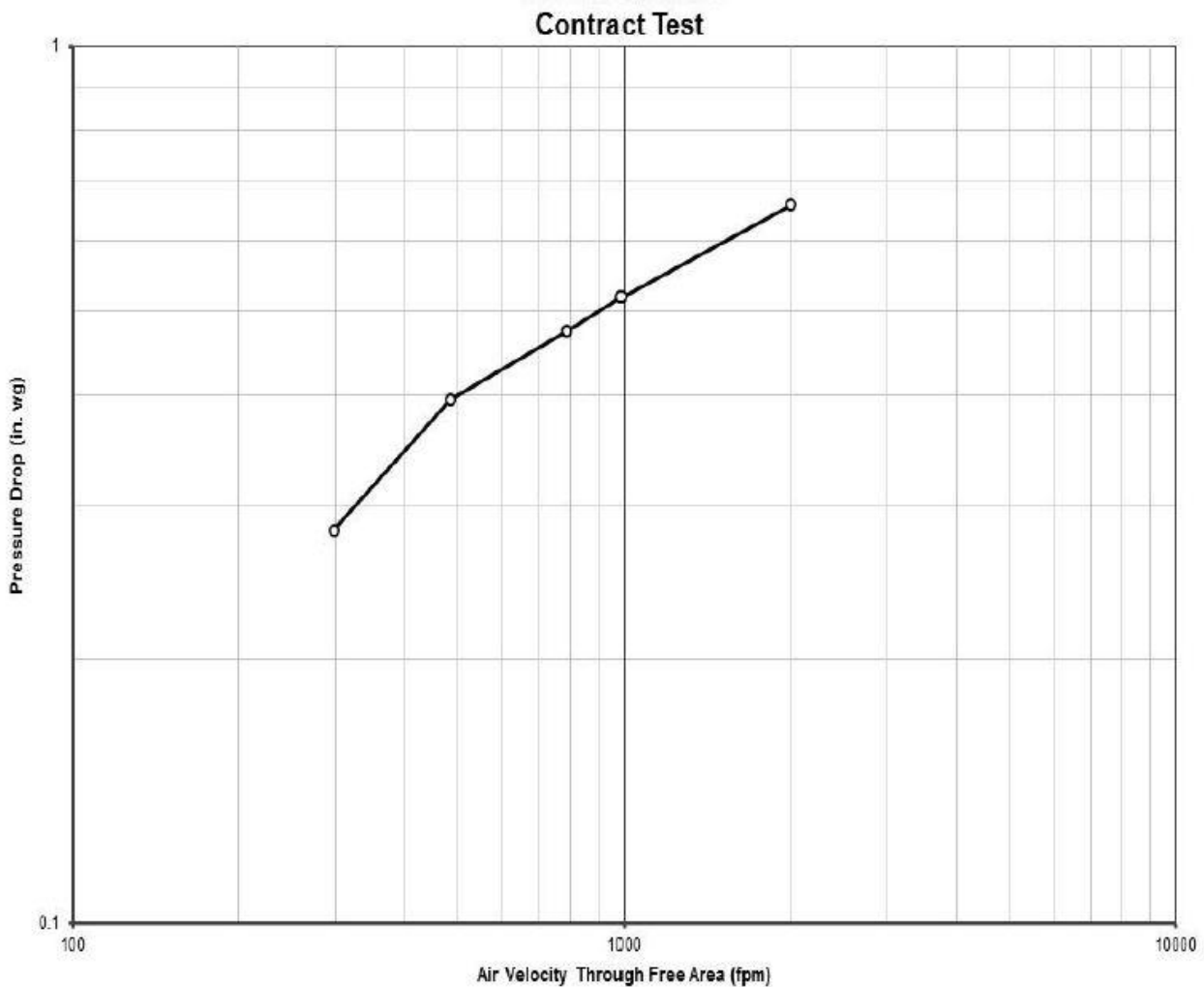



Stationary and Adjustable Louvers

JSA-D-100s



Jaesung Aluminum Co.,Ltd certifies that Model JSA-D-100s Louver shown herein is licensed to bear the AMCA Seal for Model JSA-D-100s. The ratings shown are based on tests and procedures performed in accordance with AMCA Publication 511 and comply with the requirements of the AMCA Certified Ratings Program.

The AMCA Certified Ratings Seal applies to Air Performance and Water Penetration Ratings.

Test Information

Test for Air Performance in accordance with ANSI/AMCA Standard 500-L-12(Pressure Drop), Figure 5.5.

Test sample size is 48 in X 48 in.(W1 X H1)

Air Performance

Free Area Chart(Sq.Ft.)

H" \ W"	12	18	24	30	36	42	48	54	60	66	72	78	84	90	96	102	108	114
12	5.1%	6.3%	6.8%	7.1%	7.4%	7.5%	7.6%	7.7%	7.7%	7.8%	7.8%	7.9%	7.9%	8.0%	8.0%	8.0%	8.0%	8.1%
	0.051	0.094	0.136	0.179	0.221	0.263	0.306	0.348	0.385	0.427	0.470	0.512	0.555	0.597	0.639	0.682	0.724	0.767
18	20.5%	24.9%	27.1%	28.5%	29.3%	30.0%	30.5%	30.8%	30.7%	31.0%	31.2%	31.4%	31.6%	31.7%	31.8%	32.0%	32.1%	32.1%
	0.307	0.561	0.814	1.067	1.321	1.574	1.827	2.081	2.301	2.554	2.807	3.061	3.314	3.567	3.821	4.074	4.327	4.581
24	18.2%	22.1%	24.1%	25.3%	26.1%	26.6%	27.0%	27.4%	27.2%	27.5%	27.7%	27.9%	28.0%	28.2%	28.3%	28.4%	28.5%	28.5%
	0.364	0.664	0.964	1.264	1.564	1.864	2.164	2.464	2.724	3.024	3.324	3.624	3.924	4.224	4.524	4.824	5.124	5.424
30	21.7%	26.5%	28.8%	30.2%	31.2%	31.8%	32.3%	32.7%	32.6%	32.9%	33.1%	33.3%	33.5%	33.7%	33.8%	33.9%	34.0%	34.1%
	0.544	0.992	1.440	1.889	2.337	2.785	3.234	3.682	4.071	4.520	4.968	5.416	5.865	6.313	6.761	7.210	7.658	8.106
36	20.0%	24.4%	26.5%	27.8%	28.7%	29.3%	29.8%	30.1%	30.0%	30.3%	30.5%	30.7%	30.9%	31.0%	31.1%	31.2%	31.3%	31.4%
	0.601	1.096	1.592	2.087	2.582	3.078	3.573	4.069	4.499	4.994	5.490	5.985	6.481	6.976	7.472	7.967	8.462	8.958
42	22.0%	26.8%	29.2%	30.6%	31.6%	32.2%	32.8%	33.2%	33.0%	33.3%	33.6%	33.8%	33.9%	34.1%	34.2%	34.4%	34.5%	34.6%
	0.771	1.407	2.043	2.679	3.314	3.950	4.586	5.222	5.774	6.410	7.046	7.682	8.318	8.953	9.589	10.225	10.861	11.497
48	20.9%	25.5%	27.7%	29.1%	30.0%	30.7%	31.1%	31.5%	31.4%	31.7%	31.9%	32.1%	32.3%	32.4%	32.6%	32.7%	32.8%	32.9%
	0.838	1.529	2.219	2.910	3.601	4.292	4.983	5.674	6.274	6.965	7.655	8.346	9.037	9.728	10.419	11.110	11.800	12.491
54	22.2%	27.0%	29.4%	30.8%	31.8%	32.5%	33.0%	33.4%	33.2%	33.5%	33.8%	34.0%	34.2%	34.4%	34.5%	34.6%	34.7%	34.8%
	0.998	1.822	2.645	3.468	4.292	5.115	5.938	6.762	7.477	8.300	9.124	9.947	10.770	11.594	12.417	13.240	14.064	14.887
60	20.0%	24.3%	26.5%	27.8%	28.6%	29.2%	29.7%	30.1%	29.9%	30.2%	30.4%	30.6%	30.8%	30.9%	31.1%	31.2%	31.3%	31.4%
	0.999	1.823	2.646	3.470	4.294	5.118	5.941	6.765	7.481	8.305	9.128	9.952	10.776	11.600	12.423	13.247	14.071	14.895
66	22.3%	27.1%	29.5%	31.0%	31.9%	32.6%	33.1%	33.5%	33.4%	33.7%	33.9%	34.2%	34.3%	34.5%	34.6%	34.8%	34.9%	35.0%
	1.226	2.237	3.247	4.258	5.269	6.280	7.291	8.302	9.180	10.191	11.201	12.212	13.223	14.234	15.245	16.256	17.266	18.277
72	21.9%	26.6%	29.0%	30.4%	31.3%	32.0%	32.5%	32.9%	32.7%	33.0%	33.3%	33.5%	33.7%	33.8%	34.0%	34.1%	34.2%	34.3%
	1.312	2.393	3.475	4.557	5.638	6.720	7.802	8.883	9.823	10.905	11.986	13.068	14.150	15.231	16.313	17.395	18.476	19.558
78	21.1%	25.6%	27.9%	29.3%	30.2%	30.8%	31.3%	31.7%	31.5%	31.8%	32.1%	32.3%	32.4%	32.6%	32.7%	32.9%	33.0%	33.0%
	1.369	2.497	3.626	4.755	5.883	7.012	8.141	9.269	10.250	11.379	12.507	13.636	14.765	15.893	17.022	18.151	19.279	20.408
84	22.1%	26.9%	29.3%	30.7%	31.7%	32.4%	32.9%	33.3%	33.1%	33.4%	33.7%	33.9%	34.1%	34.3%	34.4%	34.5%	34.6%	34.7%
	1.549	2.826	4.103	5.380	6.657	7.934	9.211	10.488	11.598	12.875	14.152	15.429	16.706	17.983	19.260	20.537	21.814	23.091



Stationary and Adjustable Louvers

JSA-D-100s



Jaesung Aluminum Co.,Ltd certifies that Model JSA-D-100s Louver shown herein is licensed to bear the AMCA Seal for Model JSA-D-100s. The ratings shown are based on tests and procedures performed in accordance with AMCA Publication 511 and comply with the requirements of the AMCA Certified Ratings Program.

The AMCA Certified Ratings Seal applies to Air Performance and Water Penetration Ratings.

Test Information

Test for Air Performance in accordance with ANSI/AMCA Standard 500-L-12(Pressure Drop), Figure 5.5.

Test sample size is 48 in X 48 in.(W1 X H1). Test Period 15 minutes. Data at standard air density.

Water Penetration

JSA-D-100s

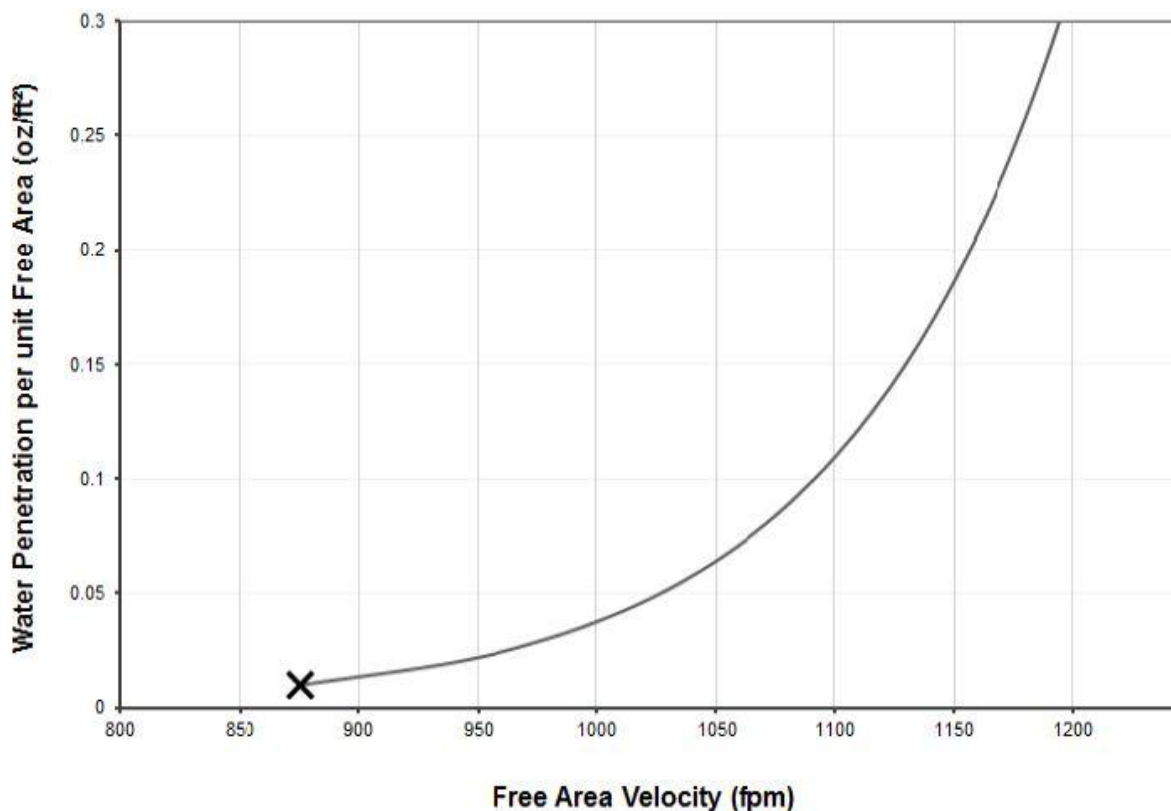

— Water Penetration per Free Area x Beginning of Water Penetration

The beginning point of water penetration for Model JSA-D-100s is 877.5 fpm free area velocity.

Construction - Dimension and details

- | | | |
|----------------|--------------------|-----------------|
| 1. UPP-FRAME | 5. OPERATING BLADE | 9. BUSHING |
| 2. LOW-FRAME | 6. SCREEN FRAME | 10. BIRD SCREEN |
| 3. SIDE FRAME | 7. FRAME COVER | 11. BLADE SEAL |
| 4. FIXED BLADE | 8. SHAFT | |

Vertical Section

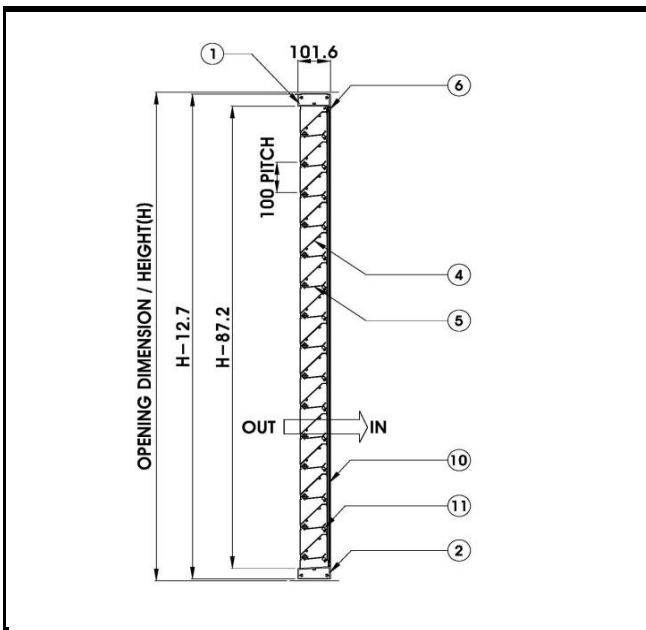

Horizontal Section

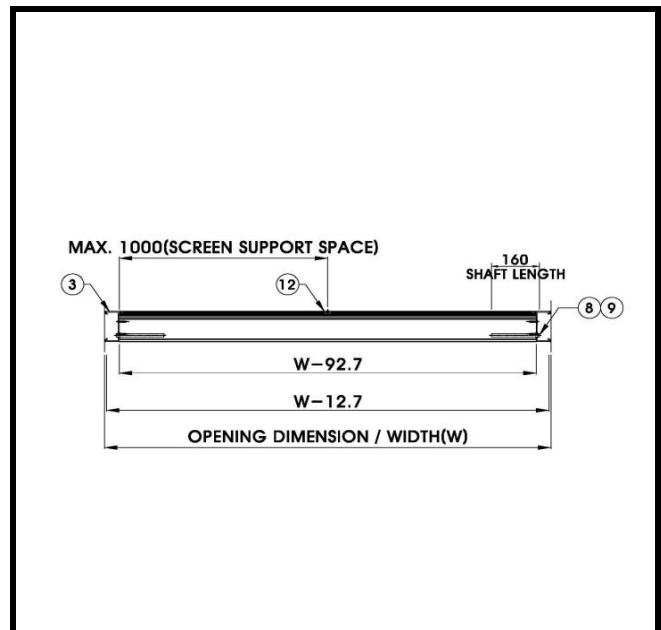

Louver Front View

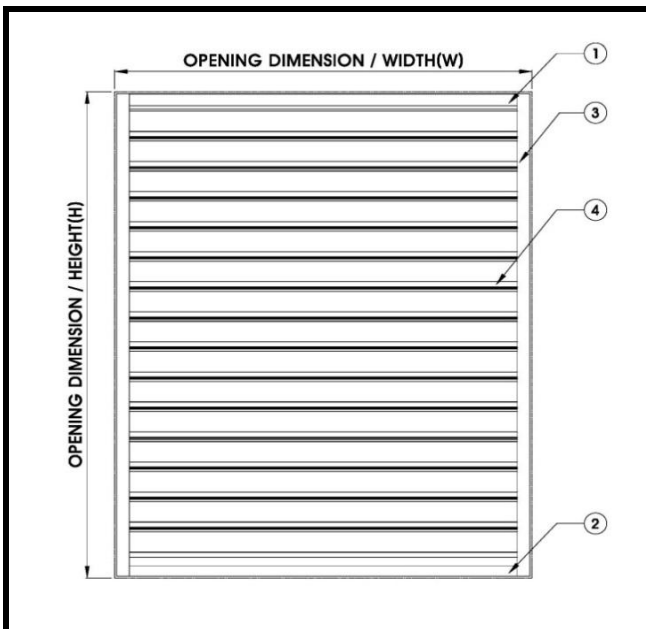

Mullion of Multiple Module

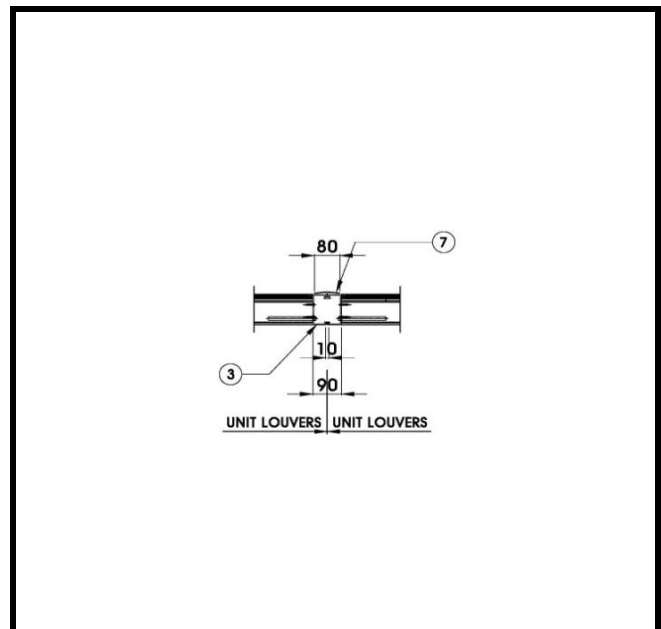

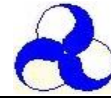

Stationary and Adjustable Louvers

JSA-E-100s



Jaesung Aluminum Co.,Ltd certifies that Model JSA-E-100s Louver shown herein is licensed to bear the AMCA Seal for Model JSA-E-100s. The ratings shown are based on tests and procedures performed in accordance with AMCA Publication 511 and comply with the requirements of the AMCA Certified Ratings Program.

The AMCA Certified Ratings Seal applies to Air Performance and Air Leakage Ratings.

Test Information

Test for air performance in accordance with ANSI/AMCA Standard 500-L-12(Pressure Drop), Figure 5.5.

Test for water penetration in accordance with ANSI/AMCA Standard 500-L-07, Figure 5.6.

Construction Standard

FRAME:

Gauge 12(3.2mm thick) formed extruded aluminum profiles.(A6063-T5)

BLADES:

Gauge 15(2.0mm thick) formed extruded aluminum profiles.(A6063-T5)

SCREEN:

Stainless steel bird screen 1/2"~3/4"(12~19) fixed in front or behind the blades.

Please note that Pressure Drop Data is obtained from Test without bird screen.

Pressure drop of bird screen is additive and to be calculated separately.

MINIMUM SIZE:

300 X 300mm(12in X 12in) - Neck Size

MAXIMUM SIZE:

2100 X 2900mm as single section(Neck Size)
2 section more module consult JAS for multiple section assembly details.

Catalog ID : JSA-E-100 July 2016

JSA-E-100s



Optional Extras

***Code A**

Finished to Anodizing.

***Code P**

Painted to PVDF.

***Code I**

Insect screen in aluminum.

***Code B**

Bird screen in stainless steel.



Stationary and Adjustable Louvers

JSA-E-100s



Jaesung Aluminum Co.,Ltd certifies that Model JSA-E-100s Louver shown herein is licensed to bear the AMCA Seal for Model JSA-E-100s. The ratings shown are based on tests and procedures performed in accordance with AMCA Publication 511 and comply with the requirements of the AMCA Certified Ratings Program.

The AMCA Certified Ratings Seal applies to Air Performance and Air Leakage Ratings.

Test Information

Test for air performance in accordance with ANSI/AMCA Standard 500-L-12(Pressure Drop), Figure 5.5.

Test sample size is 48 in X 48 in.(W1 X H1). Data at standard air density.

Air Performance

Pressure Drop

Exhaust Air Performance

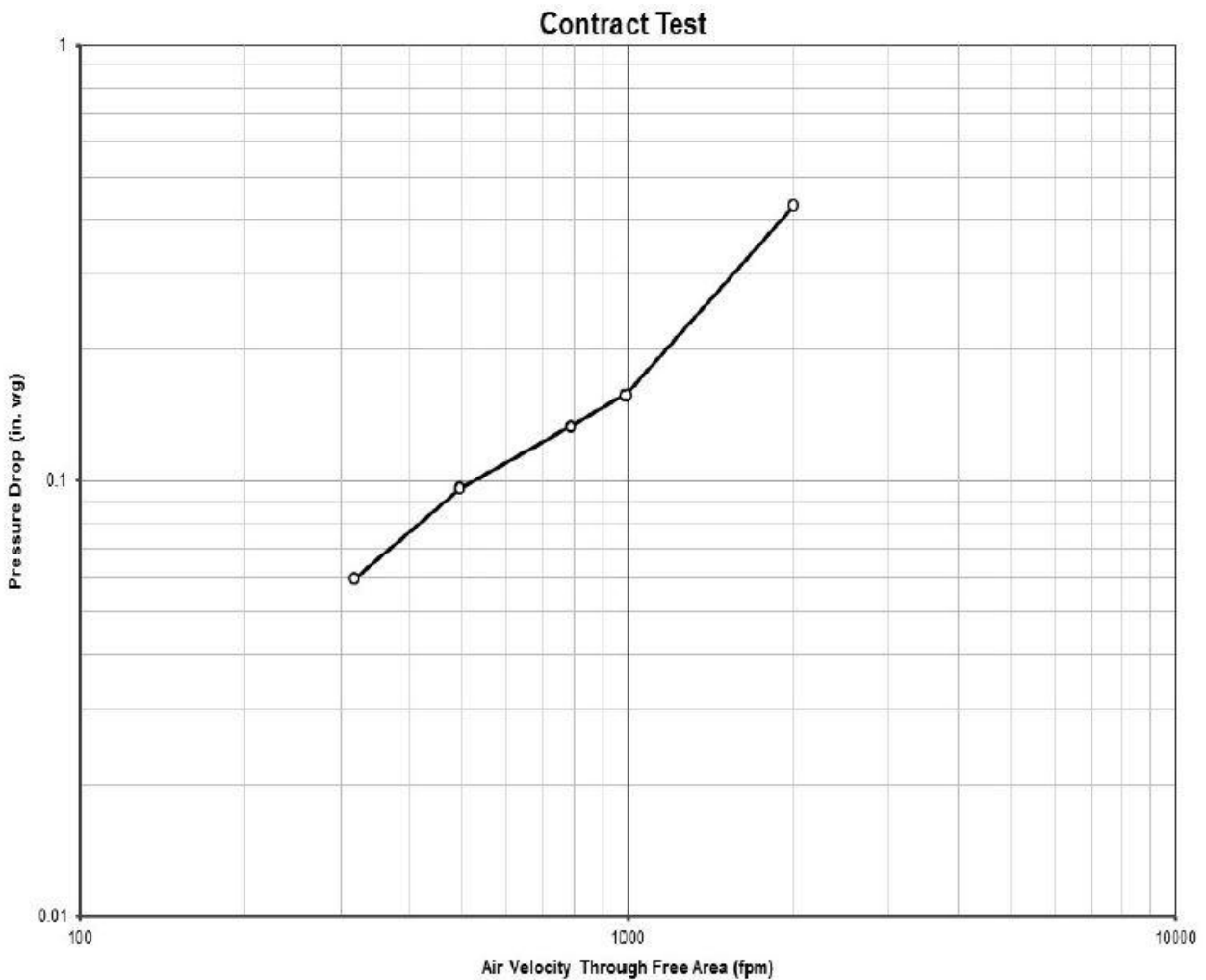

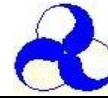

Stationary and Adjustable Louvers

JSA-E-100s



Jaesung Aluminum Co.,Ltd certifies that Model JSA-E-100s Louver shown herein is licensed to bear the AMCA Seal for Model JSA-E-100s. The ratings shown are based on tests and procedures performed in accordance with AMCA Publication 511 and comply with the requirements of the AMCA Certified Ratings Program.

The AMCA Certified Ratings Seal applies to Air Performance and Air Leakage Ratings.

Test Information

Test for air performance in accordance with ANSI/AMCA Standard 500-L-12(Pressure Drop), Figure 5.5.

Test sample size is 48 in. X 48 in.(W1 X H1).

Air Performance

Free Area Chart(Sq.Ft.)

H" \ W"	12	18	24	30	36	42	48	54	60	66	72	78	84	90	96	102	108	114
12	19.1% 0.191	23.3% 0.349	25.3% 0.507	26.6% 0.665	27.4% 0.823	28.0% 0.980	28.5% 1.138	28.8% 1.296	28.7% 1.433	28.9% 1.591	29.1% 1.749	29.3% 1.907	29.5% 2.064	29.6% 2.222	29.8% 2.380	29.9% 2.538	30.0% 2.696	30.0% 2.853
18	24.1% 0.382	29.4% 0.661	32.0% 0.959	33.5% 1.258	34.6% 1.556	35.3% 1.855	35.9% 2.154	36.3% 2.452	36.2% 2.712	36.5% 3.010	36.8% 3.309	37.0% 3.607	37.2% 3.906	37.4% 4.204	37.5% 4.503	37.7% 4.802	37.8% 5.100	37.9% 5.399
24	20.1% 0.401	24.4% 0.732	26.6% 1.064	27.9% 1.395	28.8% 1.726	29.4% 2.057	29.8% 2.388	30.2% 2.719	30.1% 3.006	30.3% 3.337	30.6% 3.668	30.8% 3.999	30.9% 4.330	31.1% 4.662	31.2% 4.993	31.3% 5.324	31.4% 5.655	31.5% 5.986
30	22.9% 0.572	27.9% 1.045	30.3% 1.517	31.8% 1.989	32.8% 2.461	33.5% 2.933	34.0% 3.405	34.5% 3.877	34.3% 4.287	34.6% 4.759	34.9% 5.231	35.1% 5.703	35.3% 6.175	35.5% 6.648	35.6% 7.120	35.7% 7.592	35.8% 8.064	35.9% 8.536
36	20.4% 0.611	24.8% 1.116	27.0% 1.620	28.3% 2.124	29.2% 2.628	29.8% 3.132	30.3% 3.636	30.7% 4.141	30.5% 4.579	30.8% 5.083	31.0% 5.587	31.2% 6.091	31.4% 6.595	31.6% 7.099	31.7% 7.604	31.8% 8.108	31.9% 8.612	32.0% 9.116
42	22.1% 0.773	26.9% 1.411	29.3% 2.049	30.7% 2.686	31.7% 3.324	32.3% 3.962	32.9% 4.600	33.3% 5.237	33.1% 5.791	33.4% 6.429	33.7% 7.067	33.9% 7.704	34.0% 8.342	34.2% 8.980	34.3% 9.618	34.5% 10.255	34.6% 10.893	34.7% 11.531
48	20.5% 0.822	25.0% 1.499	27.2% 2.177	28.5% 2.855	29.4% 3.533	30.1% 4.210	30.6% 4.888	30.9% 5.566	30.8% 6.155	31.1% 6.832	31.3% 7.510	31.5% 8.188	31.7% 8.865	31.8% 9.543	31.9% 10.221	32.1% 10.898	32.2% 11.576	32.2% 12.254
54	21.6% 0.974	26.3% 1.777	28.7% 2.581	30.1% 3.384	31.0% 4.187	31.7% 4.991	32.2% 5.794	32.6% 6.597	32.4% 7.295	32.7% 8.099	33.0% 8.902	33.2% 9.705	33.4% 10.509	33.5% 11.312	33.7% 12.115	33.8% 12.919	33.9% 13.722	34.0% 14.525
60	20.6% 1.032	25.1% 1.883	27.3% 2.735	28.7% 3.586	29.6% 4.437	30.2% 5.288	30.7% 6.140	31.1% 6.991	30.9% 7.731	31.2% 8.582	31.4% 9.433	31.6% 10.284	31.8% 11.136	32.0% 11.987	32.1% 12.838	32.2% 13.689	32.3% 14.541	32.4% 15.392
66	21.4% 1.175	26.0% 2.144	28.3% 3.113	29.7% 4.082	30.6% 5.051	31.3% 6.020	31.8% 6.989	32.2% 7.958	32.0% 8.799	32.3% 9.768	32.5% 10.737	32.7% 11.706	32.9% 12.675	33.1% 13.644	33.2% 14.613	33.3% 15.582	33.4% 16.551	33.5% 17.520
72	20.7% 1.243	25.2% 2.267	27.4% 3.292	28.8% 4.317	29.7% 5.342	30.3% 6.367	30.8% 7.391	31.2% 8.416	31.0% 9.307	31.3% 10.331	31.5% 11.356	31.7% 12.381	31.9% 13.406	32.1% 14.430	32.2% 15.455	32.3% 16.480	32.4% 17.505	32.5% 18.530
78	19.7% 1.282	24.0% 2.339	26.1% 3.397	27.4% 4.454	28.3% 5.511	28.9% 6.569	29.3% 7.626	29.7% 8.683	29.5% 9.602	29.8% 10.659	30.0% 11.716	30.2% 12.774	30.4% 13.831	30.5% 14.888	30.7% 15.945	30.8% 17.003	30.9% 18.060	31.0% 19.117
84	20.8% 1.453	25.3% 2.651	27.5% 3.850	28.8% 5.048	29.7% 6.246	30.4% 7.445	30.9% 8.643	31.2% 9.841	31.1% 10.883	31.4% 12.081	31.6% 13.279	31.8% 14.478	32.0% 15.676	32.1% 16.874	32.3% 18.073	32.4% 19.271	32.5% 20.469	32.6% 21.668

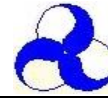

Stationary and Adjustable Louvers

JSA-E-100s



Jaesung Aluminum Co.,Ltd certifies that Model JSA-E-100s Louver shown herein is licensed to bear the AMCA Seal for Model JSA-E-100s. The ratings shown are based on tests and procedures performed in accordance with AMCA Publication 511 and comply with the requirements of the AMCA Certified Ratings Program. The AMCA Certified Ratings Seal applies to Air Performance and Air Leakage Ratings.

Test Information

Test Figure 5.4. Test sample size is 48 in X 48 in. Data at standard air density. Air leakage is based on operation between 10°C – 40°C. Gravity applied to close and seat the damper during the test.

Air Leakage

Exhaust Leakage

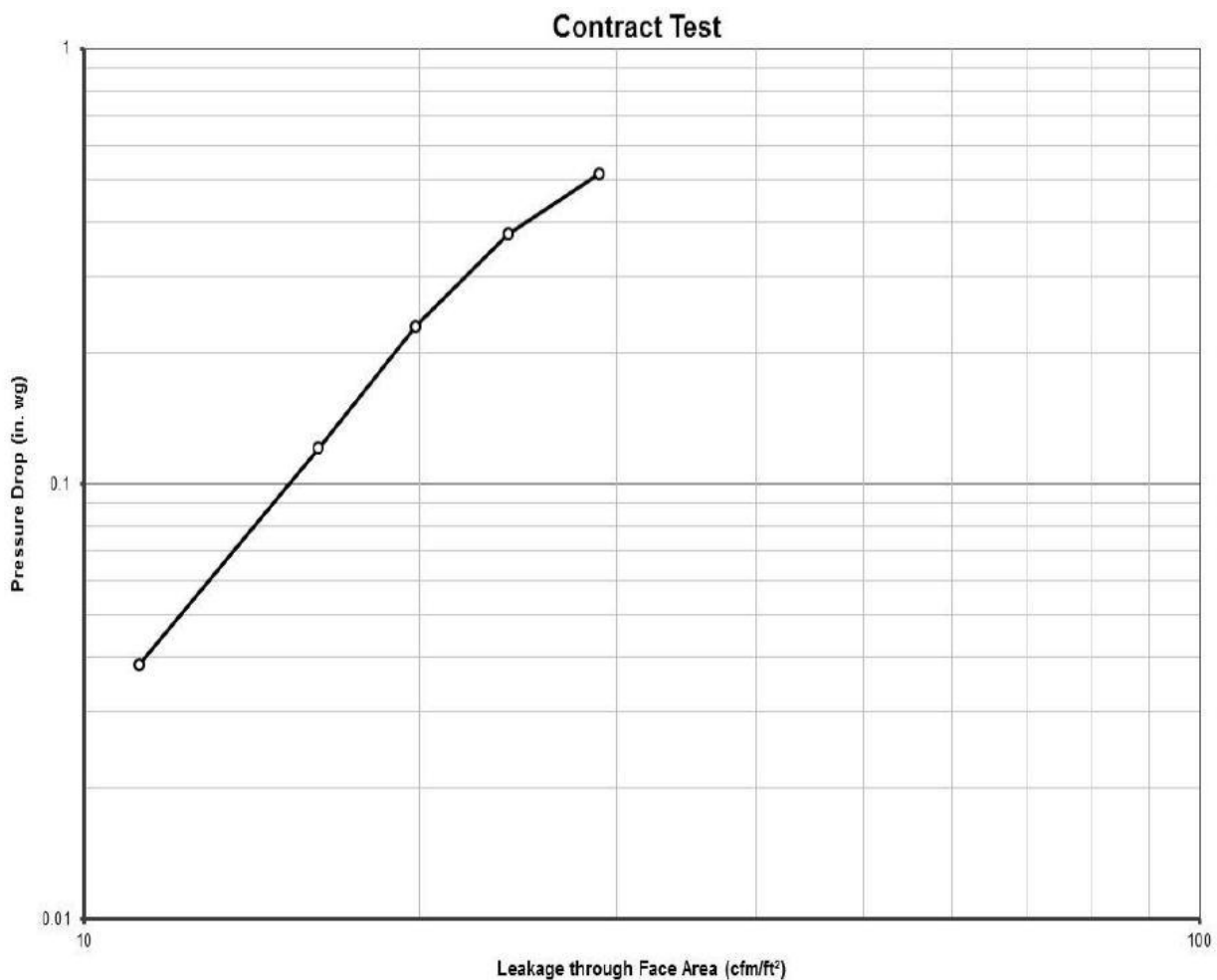

Construction - Dimension and details

- | | | |
|----------------|--------------------|-----------------|
| 1. UPP-FRAME | 5. OPERATING BLADE | 9. BUSHING |
| 2. LOW-FRAME | 6. SCREEN FRAME | 10. BIRD SCREEN |
| 3. SIDE FRAME | 7. FRAME COVER | 11. BLADE SEAL |
| 4. FIXED BLADE | 8. SHAFT | |

Vertical Section

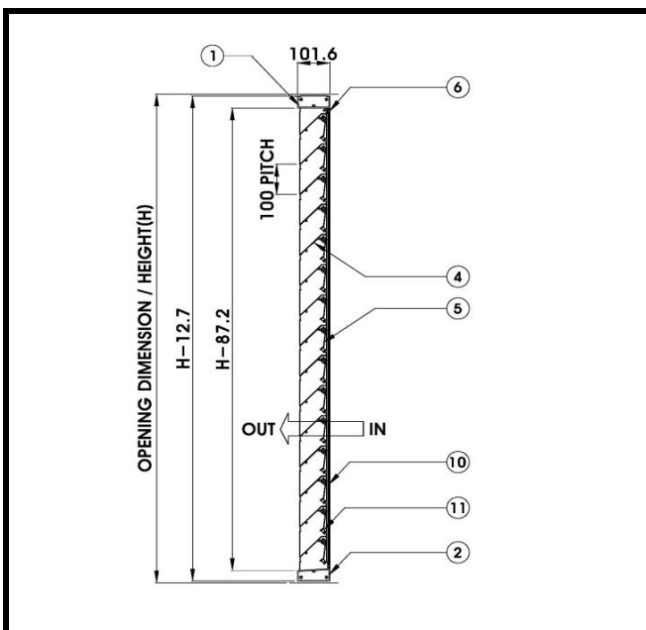

Horizontal Section

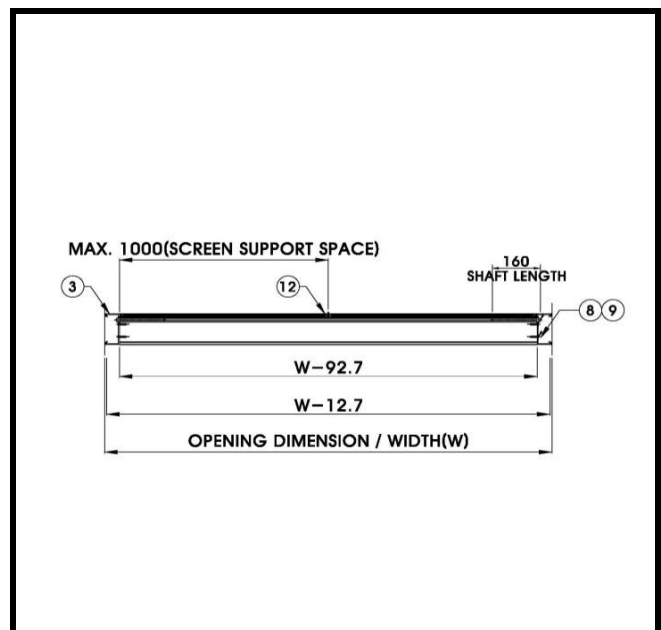

Louver Front View

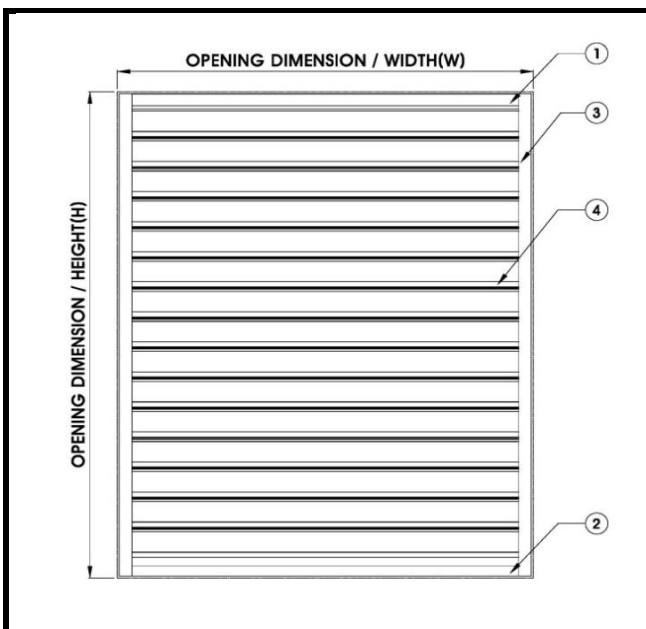

Mullion of Multiple Module

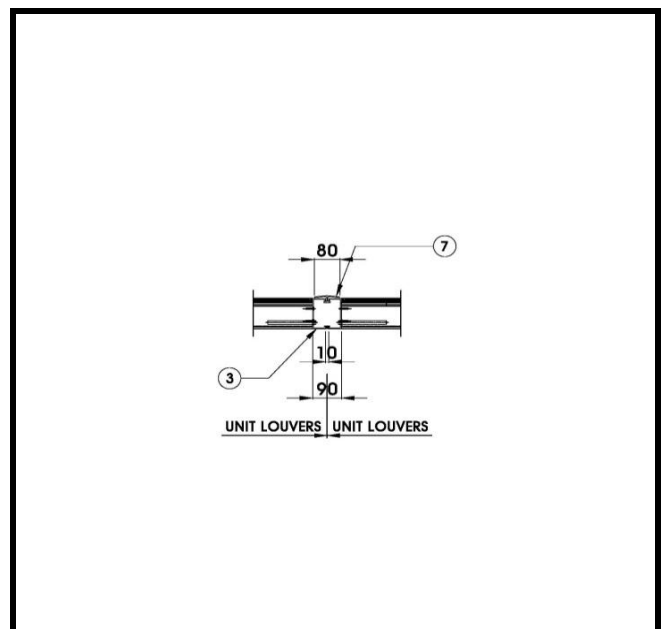

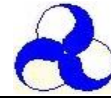

Stationary and Adjustable Louvers

JSA-F-100s

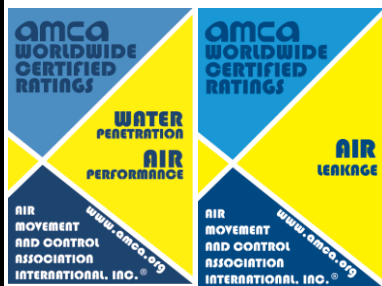

Jaesung Aluminum Co.,Ltd certifies that Model JSA-F-100s Louver shown herein is licensed to bear the AMCA Seal for Model JSA-F-100s. The ratings shown are based on tests and procedures performed in accordance with AMCA Publication 511 and comply with the requirements of the AMCA Certified Ratings Program.

The AMCA Certified Ratings Seal applies to Air Performance and Water Penetration and Air Leakage Ratings.

Test Information

Test for Air Performance in accordance with ANSI/AMCA Standard 500-L-12(Pressure Drop), Figure 5.5.

Test for water penetration in accordance with ANSI/AMCA Standard 500-L-07, Figure 5.6.

Construction Standard

FRAME:

Gauge 12(3.2mm thick) formed extruded aluminum profiles.(A6063-T5)

BLADES:

Gauge 15(2.0mm thick) formed extruded aluminum profiles.(A6063-T5)

SCREEN:

Stainless steel bird screen 1/2"~3/4"(12~19) fixed in front or behind the blades.

Please note that Pressure Drop Data is obtained from Test without bird screen.

Pressure drop of bird screen is additive and to be calculated separately.

MINIMUM SIZE:

300 X 300mm(12in X 12in) - Neck Size

MAXIMUM SIZE:

2100 X 2900mm as single section(Neck Size)
2 section more module consult JAS for multiple section assembly details.

Catalog ID : JSA-F-100 July 2016

JSA-F-100s



Optional Extras

*Code A

Finished to Anodizing.

*Code P

Painted to PVDF.

*Code I

Insect screen in aluminum.

*Code B

Bird screen in stainless steel.

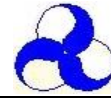

Stationary and Adjustable Louvers

JSA-F-100s



Jaesung Aluminum Co.,Ltd certifies that Model JSA-F-100s Louver shown herein is licensed to bear the AMCA Seal for Model JSA-F-100s. The ratings shown are based on tests and procedures performed in accordance with AMCA Publication 511 and comply with the requirements of the AMCA Certified Ratings Program.

The AMCA Certified Ratings Seal applies to Air Performance and Water Penetration and Air Leakage Ratings.

Test Information

Test for Air Performance in accordance with ANSI/AMCA Standard 500-L-12(Pressure Drop), Figure 5.5.

Test sample size is 48 in X 48 in.(W1 X H1). Data at standard air density.

Air Performance

Pressure Drop

Intake Air Performance

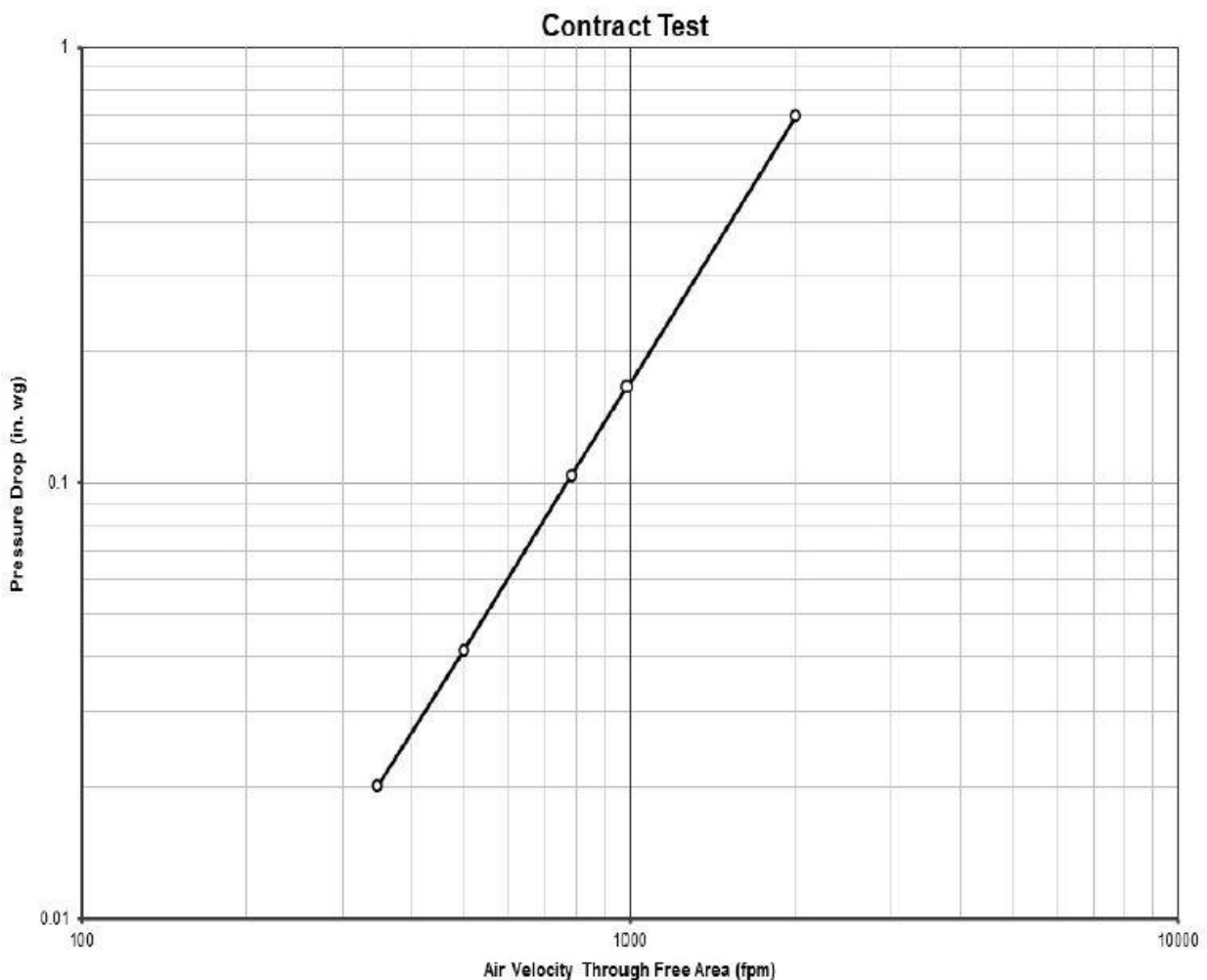

Catalog ID : JSA-F-100 July 2016

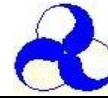

Stationary and Adjustable Louvers

JSA-F-100s

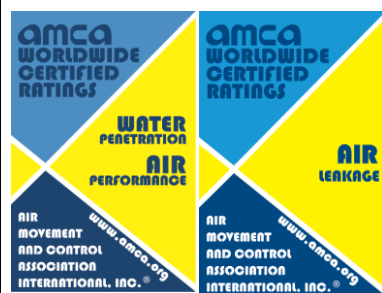

Jaesung Aluminum Co.,Ltd certifies that Model JSA-F-100s Louver shown herein is licensed to bear the AMCA Seal for Model JSA-F-100s. The ratings shown are based on tests and procedures performed in accordance with AMCA Publication 511 and comply with the requirements of the AMCA Certified Ratings Program.

The AMCA Certified Ratings Seal applies to Air Performance and Water Penetration and Air Leakage Ratings.

Test Information

Test for Air Performance in accordance with ANSI/AMCA Standard 500-L-12(Pressure Drop), Figure 5.5.

Test sample size is 48 in X 48 in.(W1 X H1).

Air Performance

Free Area Chart(Sq.Ft.)

H" \ W"	12	18	24	30	36	42	48	54	60	66	72	78	84	90	96	102	108	114
12	4.3%	7.6%	9.2%	10.2%	10.8%	11.3%	11.7%	11.9%	12.0%	12.2%	12.3%	12.5%	12.6%	12.7%	12.8%	12.9%	12.9%	13.0%
	0.043	0.113	0.184	0.255	0.325	0.396	0.467	0.538	0.599	0.670	0.740	0.811	0.882	0.953	1.023	1.094	1.165	1.235
18	7.6%	13.5%	16.4%	18.2%	19.3%	20.2%	20.8%	21.3%	21.4%	21.7%	22.0%	22.3%	22.5%	22.7%	22.8%	23.0%	23.1%	23.2%
	0.114	0.303	0.492	0.681	0.871	1.060	1.249	1.438	1.602	1.792	1.981	2.170	2.359	2.548	2.737	2.927	3.116	3.305
24	8.9%	15.8%	19.3%	21.4%	22.7%	23.7%	24.5%	25.0%	25.1%	25.5%	25.9%	26.2%	26.4%	26.6%	26.8%	27.0%	27.1%	27.3%
	0.179	0.475	0.772	1.068	1.365	1.661	1.958	2.254	2.512	2.809	3.105	3.402	3.698	3.995	4.291	4.588	4.884	5.181
30	10.7%	19.1%	23.2%	25.7%	27.4%	28.6%	29.4%	30.1%	30.2%	30.7%	31.1%	31.5%	31.8%	32.0%	32.3%	32.5%	32.6%	32.8%
	0.269	0.715	1.161	1.607	2.052	2.498	2.944	3.390	3.778	4.224	4.670	5.116	5.562	6.008	6.454	6.900	7.345	7.791
36	12.0%	21.2%	25.8%	28.6%	30.4%	31.8%	32.8%	33.5%	33.6%	34.2%	34.6%	35.0%	35.4%	35.6%	35.9%	36.1%	36.3%	36.5%
	0.359	0.954	1.549	2.145	2.740	3.335	3.931	4.526	5.043	5.639	6.234	6.830	7.425	8.020	8.616	9.211	9.806	10.402
42	13.8%	24.4%	29.8%	33.0%	35.1%	36.6%	37.7%	38.6%	38.7%	39.4%	39.9%	40.4%	40.7%	41.1%	41.4%	41.6%	41.9%	42.1%
	0.482	1.282	2.083	2.883	3.684	4.484	5.284	6.085	6.780	7.580	8.381	9.181	9.982	10.782	11.582	12.383	13.183	13.983
48	13.9%	24.6%	30.0%	33.2%	35.3%	36.9%	38.0%	38.9%	39.0%	39.7%	40.2%	40.6%	41.0%	41.4%	41.7%	41.9%	42.1%	42.3%
	0.555	1.476	2.397	3.318	4.239	5.160	6.081	7.002	7.802	8.723	9.644	10.565	11.486	12.407	13.328	14.249	15.170	16.092
54	13.9%	24.7%	30.1%	33.3%	35.5%	37.0%	38.2%	39.1%	39.2%	39.8%	40.4%	40.8%	41.2%	41.6%	41.9%	42.1%	42.3%	42.6%
	0.627	1.669	2.710	3.751	4.792	5.834	6.875	7.916	8.821	9.862	10.903	11.945	12.986	14.027	15.069	16.110	17.151	18.192
60	14.0%	24.8%	30.2%	33.5%	35.7%	37.2%	38.4%	39.3%	39.4%	40.0%	40.6%	41.0%	41.4%	41.7%	42.0%	42.3%	42.5%	42.7%
	0.700	1.862	3.024	4.186	5.348	6.510	7.672	8.834	9.843	11.005	12.167	13.329	14.491	15.653	16.815	17.977	19.139	20.300
66	14.0%	24.9%	30.3%	33.6%	35.8%	37.3%	38.5%	39.4%	39.5%	40.2%	40.7%	41.2%	41.5%	41.9%	42.2%	42.4%	42.7%	42.9%
	0.773	2.055	3.338	4.620	5.903	7.186	8.468	9.751	10.865	12.148	13.430	14.713	15.996	17.278	18.561	19.843	21.126	22.409
72	14.1%	25.0%	30.4%	33.7%	35.9%	37.4%	38.6%	39.5%	39.6%	40.3%	40.8%	41.3%	41.7%	42.0%	42.3%	42.6%	42.8%	43.0%
	0.845	2.249	3.652	5.055	6.458	7.862	9.265	10.668	11.887	13.291	14.694	16.097	17.500	18.904	20.307	21.710	23.113	24.517
78	14.1%	25.0%	30.5%	33.8%	36.0%	37.5%	38.7%	39.6%	39.7%	40.4%	40.9%	41.4%	41.8%	42.1%	42.4%	42.7%	42.9%	43.1%
	0.918	2.441	3.965	5.488	7.012	8.535	10.059	11.582	12.906	14.429	15.953	17.476	19.000	20.523	22.047	23.570	25.094	26.618
84	14.1%	25.0%	30.5%	33.8%	36.0%	37.5%	38.7%	39.6%	39.7%	40.4%	40.9%	41.4%	41.8%	42.1%	42.4%	42.7%	42.9%	43.1%
	0.989	2.630	4.271	5.912	7.554	9.195	10.836	12.477	13.903	15.545	17.186	18.827	20.468	22.110	23.751	25.392	27.033	28.675

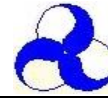

Stationary and Adjustable Louvers

JSA-F-100s



Jaesung Aluminum Co.,Ltd certifies that Model JSA-F-100s Louver shown herein is licensed to bear the AMCA Seal for Model JSA-F-100s. The ratings shown are based on tests and procedures performed in accordance with AMCA Publication 511 and comply with the requirements of the AMCA Certified Ratings Program.

The AMCA Certified Ratings Seal applies to Air Performance and Water Penetration and Air Leakage Ratings.

Test Information

Test sample size is 48 in X 48 in.(W1 X H1). Test Period 15 minutes. Data at standard air density.

Water Penetration

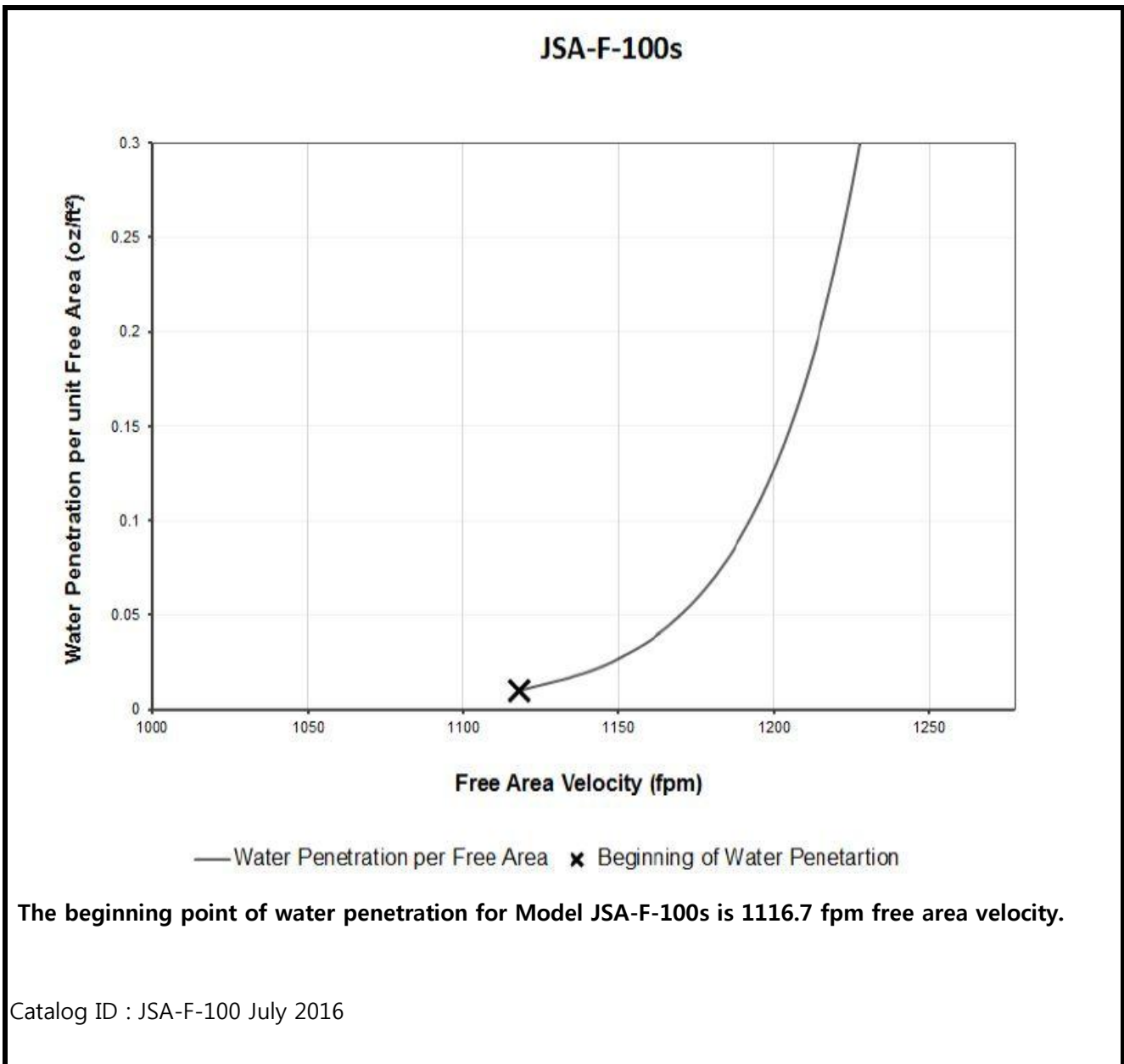

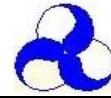

Stationary and Adjustable Louvers

JSA-F-100s



Jaesung Aluminum Co.,Ltd certifies that Model JSA-F-100s Louver shown herein is licensed to bear the AMCA Seal for Model JSA-F-100s. The ratings shown are based on tests and procedures performed in accordance with AMCA Publication 511 and comply with the requirements of the AMCA Certified Ratings Program. The AMCA Certified Ratings Seal applies to Air Performance and Water Penetration and Air Leakage Ratings.

Test Information

Test Figure 5.4. Test sample size is 48 in X 48 in. Data at standard air density. Air leakage is based on operation between 10°C – 40°C. Data are based on a torque of 3.8 in.-lb/ft² applied to close and seat the damper during the test.

Air Leakage

Intake Leakage

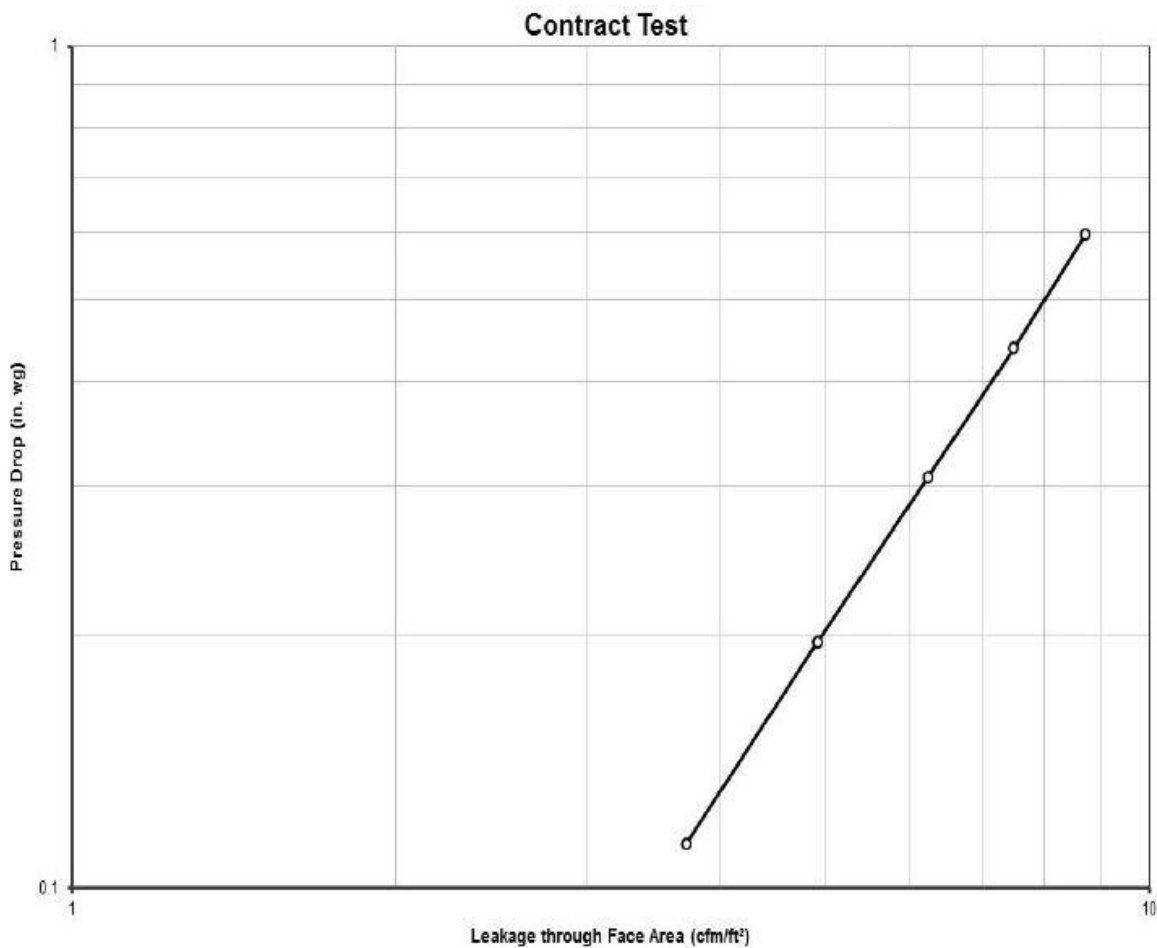

Construction - Dimension and details

1. UPP-FRAME	5. FIXED BLAED	9. SCREEN SUPPORT BAR	13. BLADE SEAL
2. LOW-FRAME	6. SCREEN BAR	10. LOW-BAFFLE	14. SHAFT 15. BUSHING
3. SIDE FRAME	7. SIDE BAFFLE	11. BIRD SCREEN	16. LINK ARM 17. LINKAGE
4. SIDE FRAME-1	8. SCREEN SUPPORT	12. OPERATING BLADE	18. HANDEL

Vertical Section

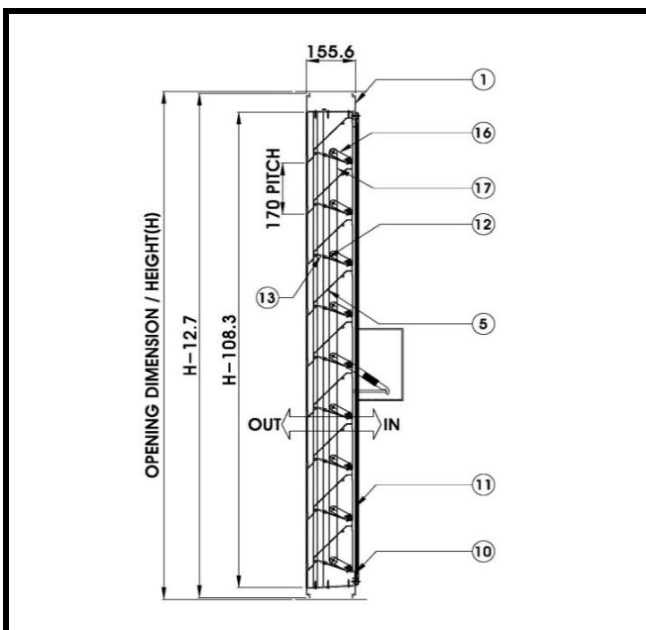

Horizontal Section

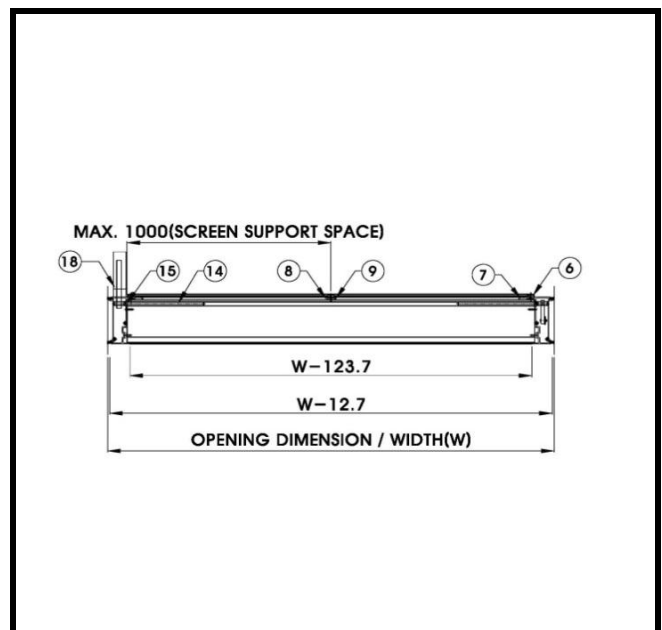

Louver Front View

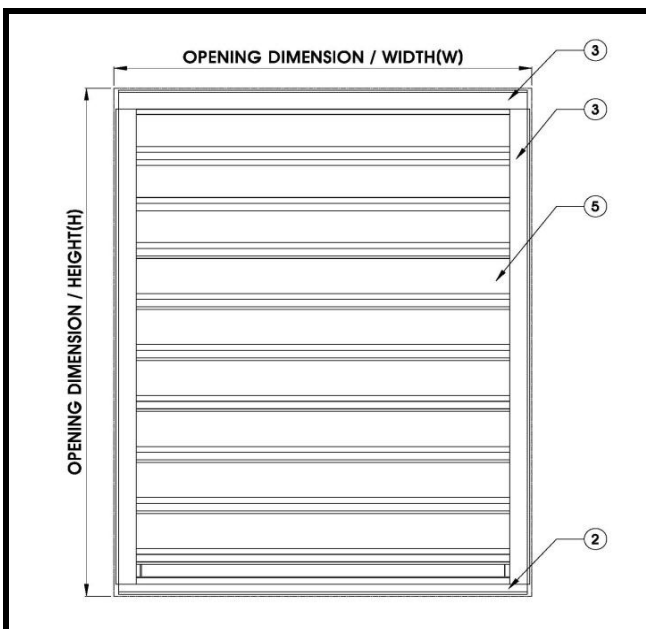

Mullion of Multiple Module

