

Vane Axial Flow Fans

- Direct Driven
- Belt Driven



A09-E

Dongguan Wolter Chemco Ventilation Ltd. certifies that the series AXV-E shown herein are licensed to bear the AMCA Seal. The ratings shown are based on tests and procedures performed in accordance with AMCA Publication 211 and AMCA Publication 311 and comply with the requirements of the AMCA Certified Ratings Program.



Contents	Page 1
Fan Type Code	Page 2
Design Features	Page 2
Fan Installation, Forms of Running	Page 3
Selection Selection Sample	Page 4
AMCA FEG Rating	Page 5
Fan Performance Curves - 50Hz	Page 6~19
AMCA FEG Rating	Page 20
Fan Performance Curves - 60Hz	Page 21~34
Dimensions	Page 35~36
Accessories	Page 37
Sound Information	Page 38~39
Tubular sound attenuator for AXV-E	Page 40~41

Subject to change without prior notice.

Fan type code

AXV-E 800 / 50°

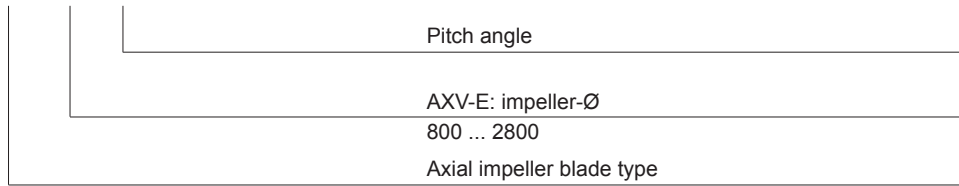

Design features

Types and duty range

Wolter vane axial fans can be used for various applications in ventilation and process air technology. Standard diameters range from 800 to 2,800 mm, with airflow rates of up to 300 m³/s at static pressure increases of up to 2,500 Pa. The high efficiencies and high pressures are achieved by the use of the aerodynamically designed outlet guide vanes.

Application

The AXV-E range of vane axial fans is designed and tested to operate at standard temperatures as well as at elevated temperatures of 300°C for 60 (F300) and 120 minutes and 400°C for at least 120 minutes (F400), according to DIN EN ISO 12101, part 3. The following fan curves are valid for standard temperatures and 300°/60(120) minutes operation. To select a fan for 400°C/120 minutes operation, please contact our technical support.

Well suited for industrial applications, ventilation and for conveying clean and dusty air where medium pressures are required with a high airflow volume and fan efficiency.

Casing

Fan casings are made of steel, with flanges rolled on both sides. The pitch circles of holes are in accordance with DIN 24 154, R2. The fan casings are hot dipped galvanised as standard. Optional: Optimal corrosion protection by powder-coating.

If motors require additional lubrication, tubes and grease-nipples are fitted to the outside of the fan casing. An inspection hole, closed by a rubber plug, allows controlling the direction of rotation.

Impellers

Hubs and impeller blades are made of highly corrosion resistant pressure-cast aluminium alloy. The aero dynamical profile of the impeller blades guarantees a high level of efficiency and low noise. The blade angle is adjustable during standstill. The variable number of blades expands the performance range. Dynamically balanced according to DIN ISO 1940-1, balancing quality G6.3.

Motors

Wolter uses closed squirrel cage motors according to IEC 34, if required also in accordance with EPACT. Standard motors are class F with IP 55 protection class. Multi speed versions with 2 or 3 speeds (Dahlander circuit or separate windings) are also available, as well as explosion-proof versions or specific industrial executions such as marine-type fans. The motor bearings have a L 10 life.

Fan performance curves

The performance curves for these fan types have been established in installation type - D (according to AMCA 210, ducted inlet and ducted outlet) and represent the total pressure increase Δp_t as a function of the volume flow. The dynamic pressure p_{d2} refers to the outlet area of the fan.

Sound levels

The ascertaining of sound level follows the Reverberant Room Method according to AMCA 300. The A-weighted inlet sound power levels L_{wIA} is shown on the performance curves.

Belt driven design

Belt driven fan with single / dual motors can be mounted in various positions to suit the actual site condition. Belt driven fans are used for applications to extract more heavily polluted air i.e. presence of corrosive or hazardous fumes, or dirt-laden, moist air or hot air from professional kitchens. Various mounting positions are illustrated.

Ordering designations

When ordering, please provide the following information:

- › Fan type
- › Fan code and type
- › Quantity required
- › Duty required at standard air and temperature (air volume in m³/h at static pressure in Pa).
- › Motor power rating in kW
- › Electrical supply
- › Ancillaries required

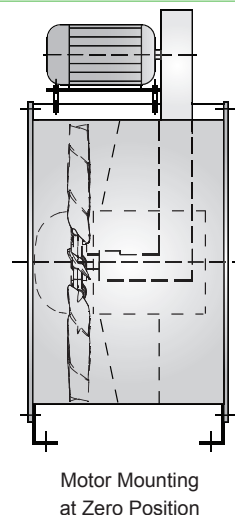
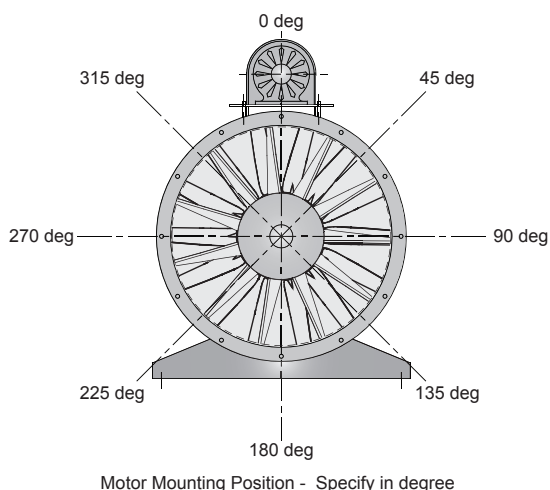

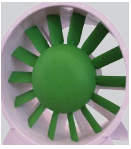

AXV-E

Fan selection and installation

Fan selection

Please select fans according to the nearest performance curve above the required duty point. The middle range of each fan curve is the area of highest efficiency. Do not select fans at the upper end of the fan curve, as this might cause the fan to work in stall. In order to avoid motor overloading, please select motors according to the peak power of the respective performance curve. Please refer to the selection example on the following page.

Fan installation

When installing the fan, please consider the following instructions:

- Fans with free inlet and outlet should be installed with an unobstructed distance of at least 1,5 x fan diameter on suction and pressure sides. Fans should have a bellmouth on the inlet side in order to assure optimal incoming flow. A diffusor mounted on the pressure side will increase efficiency.

- When installing fans in a ducted system, adequate distance to other structural parts such as bends, filters and silencers should be provided for. A sharp bend radius of the duct near the suction or pressure side of the fan is to be avoided. Flexible connections are to be installed in a way that does not obstruct the outlet cross section of the fan (see following page).

Forms of running

Wolter axial flow fans are available for all forms of running. The chart below shows all standard forms of running. Please indicate the required configuration when ordering. Arrows outside the fan casing indicates the correct direction of rotation and airflow.

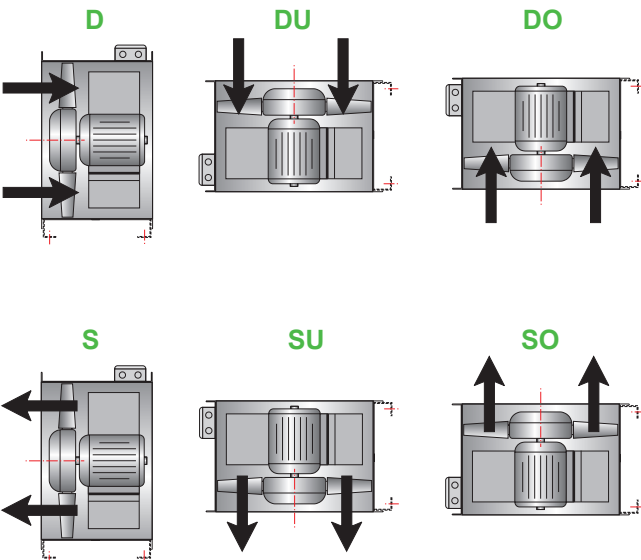
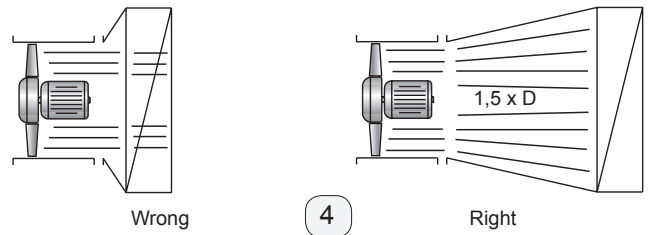
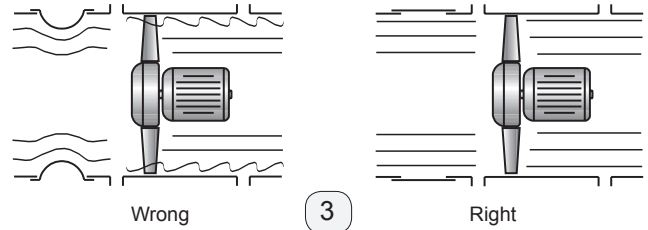
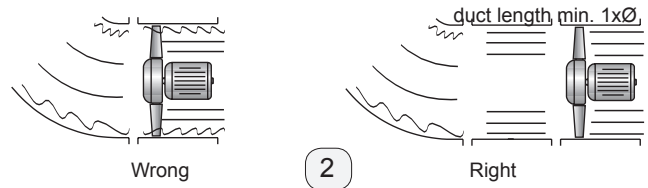
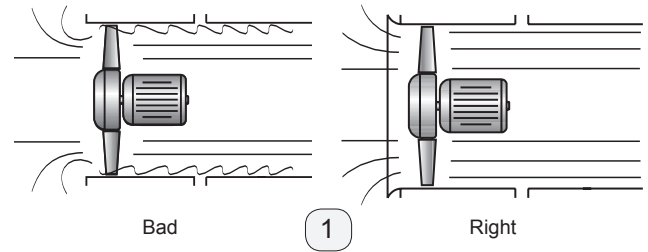

Selection example

Required duty point

- › Volume flow: 7 m³/s
- › Static pressure: 900 Pa
 - In order to calculate the total pressure, please add velocity pressure to static pressure (120 Pa dynamic pressure + 900 Pa static pressure = 1020 Pa total pressure)
- › Fan speed: 1.500 1/min (4-pole)

Using the fan curve

Having chosen a fan with adequate performance range for the required duty point, plot volume flow and pressure.

At the point of intersection, the following data can be read:

- › Motor speed or number of poles 1.500 1/min - 4-pole
- › Pitch angle: 50 degrees
- › Absorbed power: 13,40 kW
- › Sound Power Level: 109 dBA

Calculation of motor power

There are two possibilities to calculate the motor power:

- 1) Calculation of absorbed power by using the fan curve in duty point: 13,40 kW
 Motor power: 15 kW
- 2) Calculation according to peak absorbed power, see table below the fan curve: 14,36 kW
 Motor power: 15 kW

The given peak absorbed power is the maximum shaft absorbed power over the whole pitch angle curve in.

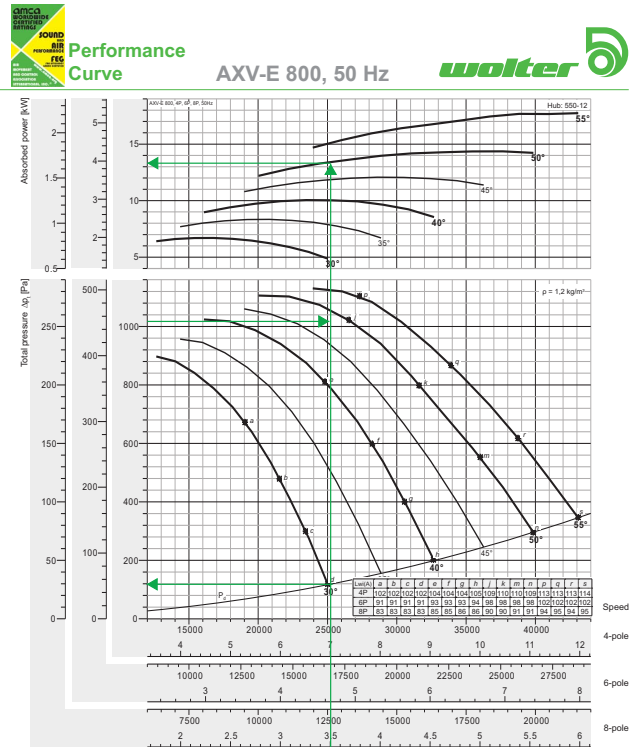

Peak absorbed power [kW]

N Poles	Pitch angle [°]						
	25	30	35	40	45	50	55
4P motor	-	6,70	8,34	10,05	12,07	14,36	17,74
6P motor	-	7,5	11	-	15	-	18,5
8P motor	-	1,98	2,47	2,98	3,58	4,26	5,26
motor	-	2,2	3	-	4	5,5	-
8P motor	-	0,838	1,04	1,26	1,51	1,80	2,22
motor	-	1,1	-	1,5	2,2	-	3

4-pole = 1500 rpm; 6-pole = 1000 rpm; 8-pole = 750 rpm

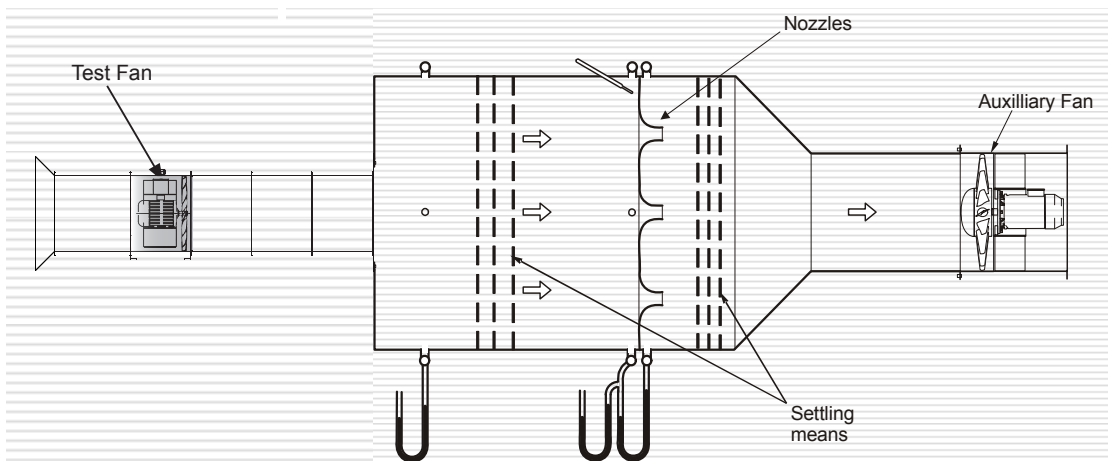

AMCA 210 Figure 12
ISO 5801 Figure 73b



Certified FEGs are determined in accordance with AMCA 205-12 Energy Efficiency Classification for fans. In conjunction with AMCA 211-05 (Rev. 6/12) Certified Ratings Program, Product Rating Manual for Fan Air Performance. This classification is based on fan peak (optimum) total efficiency for a given fan speed, fan size and application category. For the purpose of energy classification, the peak efficiency can be determined at a speed not higher than the maximum design speed of the fan.

The AMCA Certified Ratings Seal applies to the Fan Efficiency Grade (FEG) for AXV-E series Axial Fan model AXV-E 800 to AXV-E 2800 as shown in the table below.

Fan Model No.	Fan Speed (rpm)	Fan Outlet Area (m ²)	Fan Efficiency Grades	Fan Model No.	Fan Speed (rpm)	Fan Outlet Area (m ²)	Fan Efficiency Grade
AXV-E 800	1500/1000/750	0,4989	FEG60	AXV-E 1800	1000/750/600	2,5588	FEG67
AXV-E 900	1500/1000/750	0,6277	FEG63	AXV-E 2000	1000/750/600	3,1573	FEG67
AXV-E 1000	1500/1000/750	0,7901	FEG67	AXV-E 2200	750/600/500	3,8186	FEG67
AXV-E 1120	1500/1000/750	0,9940	FEG67	AXV-E 2400	750/600/500	4,5428	FEG67
AXV-E 1250	1500/1000/750	1,2272	FEG67	AXV-E 2500	750/600/500	4,9284	FEG67
AXV-E 1400	1000/750/600	1,5504	FEG67	AXV-E 2600	750/600/500	5,3297	FEG67
AXV-E 1600	1000/750/600	2,0232	FEG67	AXV-E 2800	750/600/500	6,1795	FEG67

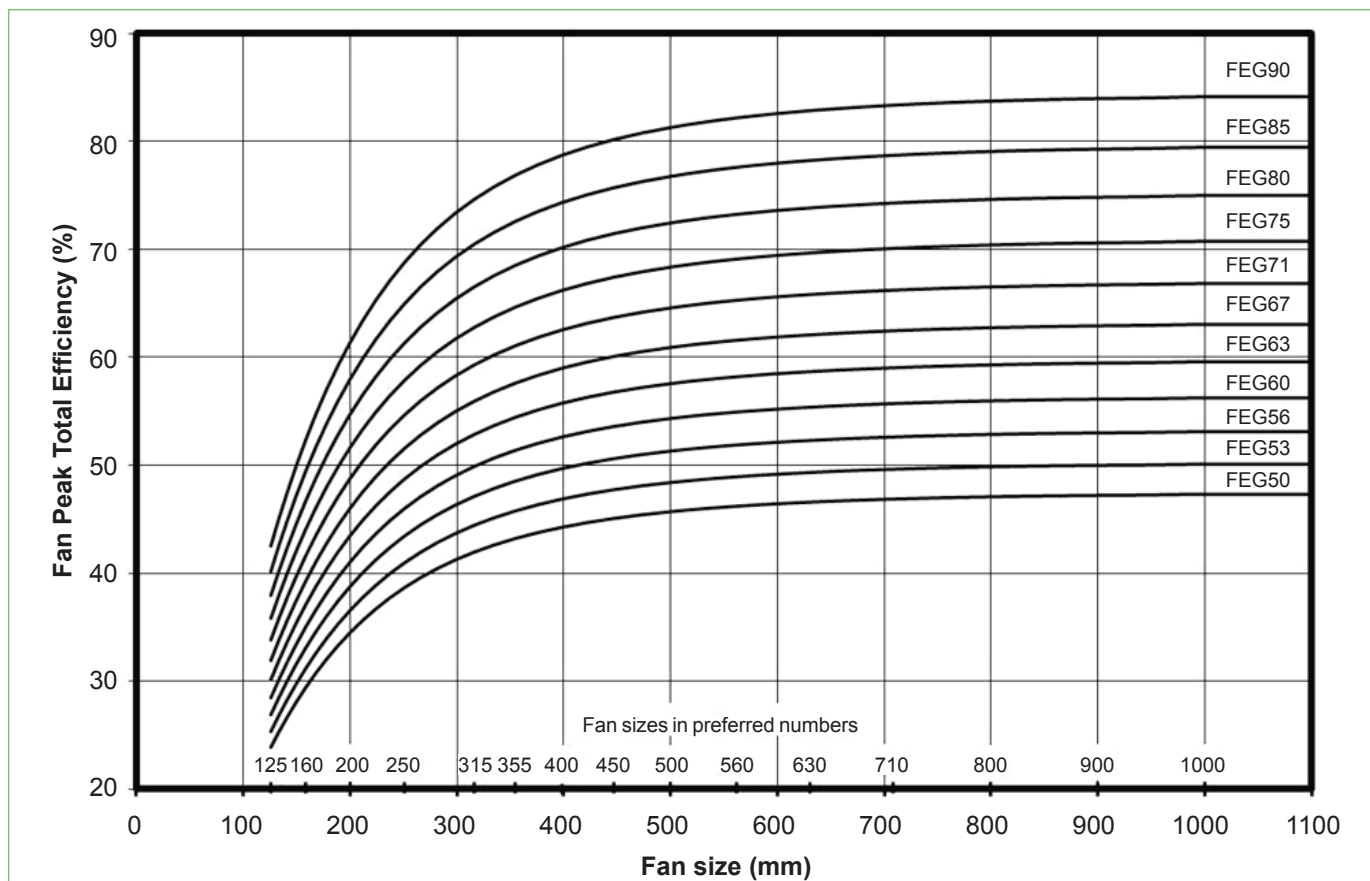



Performance Curve

AXV-E 800, 50 Hz

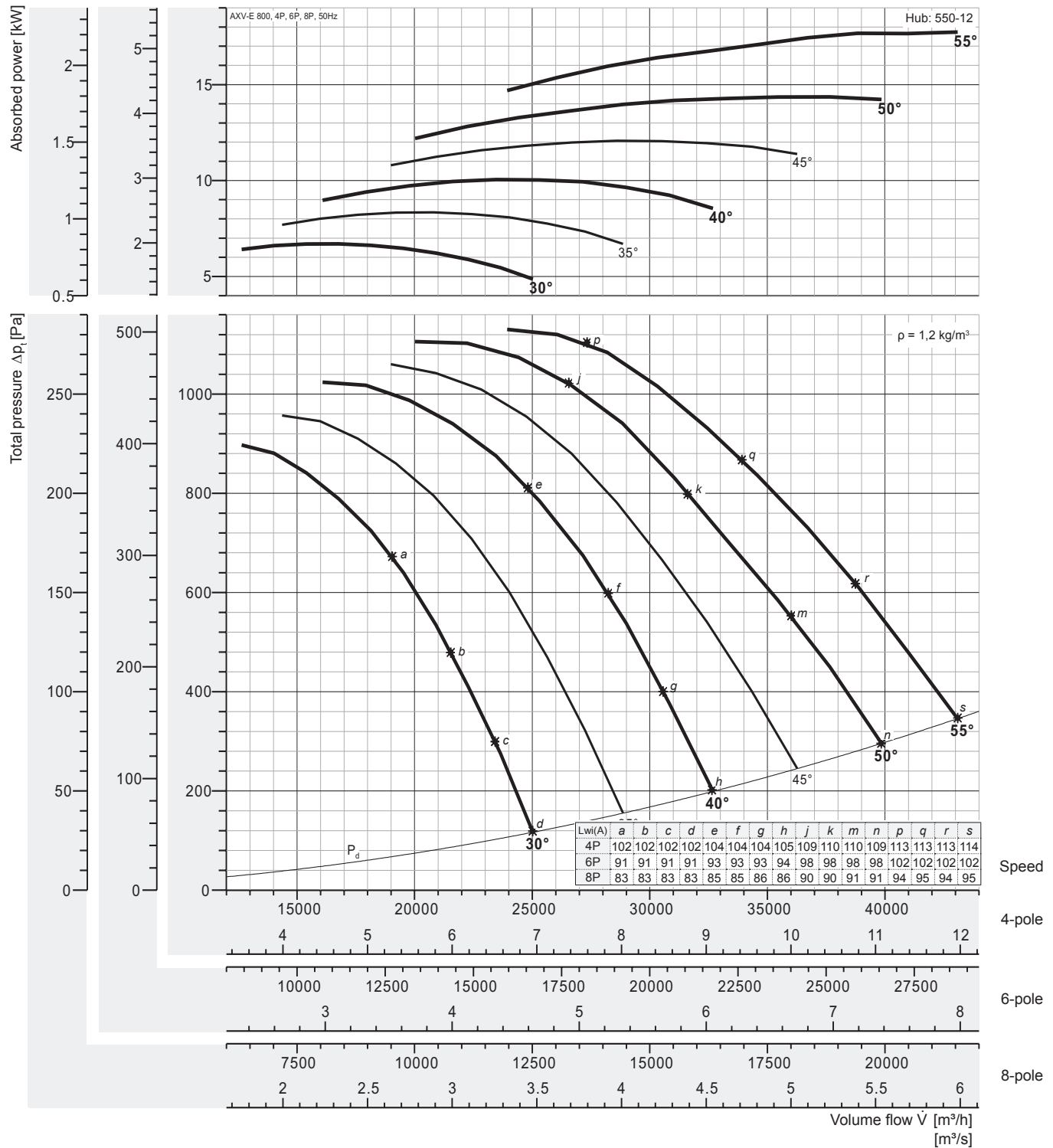

Peak absorbed power [kW]

4-pole = 1500 rpm; 6-pole = 1000 rpm; 8-pole = 750 rpm;

N Poles	Pitch angle [°]						
	25	30	35	40	45	50	55
4P motor	-	6,70	8,34	10,05	12,07	14,36	17,74
6P motor	-	1,98	2,47	2,98	3,58	4,26	5,26
8P motor	-	0,838	1,04	1,26	1,51	1,80	2,22

Fan test laboratory AMCA 210/99 Fig.12, Test Chamber. Performance certified is for installation type D - Ducted inlet, Ducted outlet. Performance ratings do not include the effects of appurtenances (accessories-belt cover, pulley & belt). Power rating (kW) does not include transmission losses.

The A-weighted sound ratings shown have been calculated per AMCA International Standard 301. Values shown are for inlet Lw(A) sound power levels for installation Type D: ducted inlet, ducted outlet. Ratings include the effects of duct end correction.

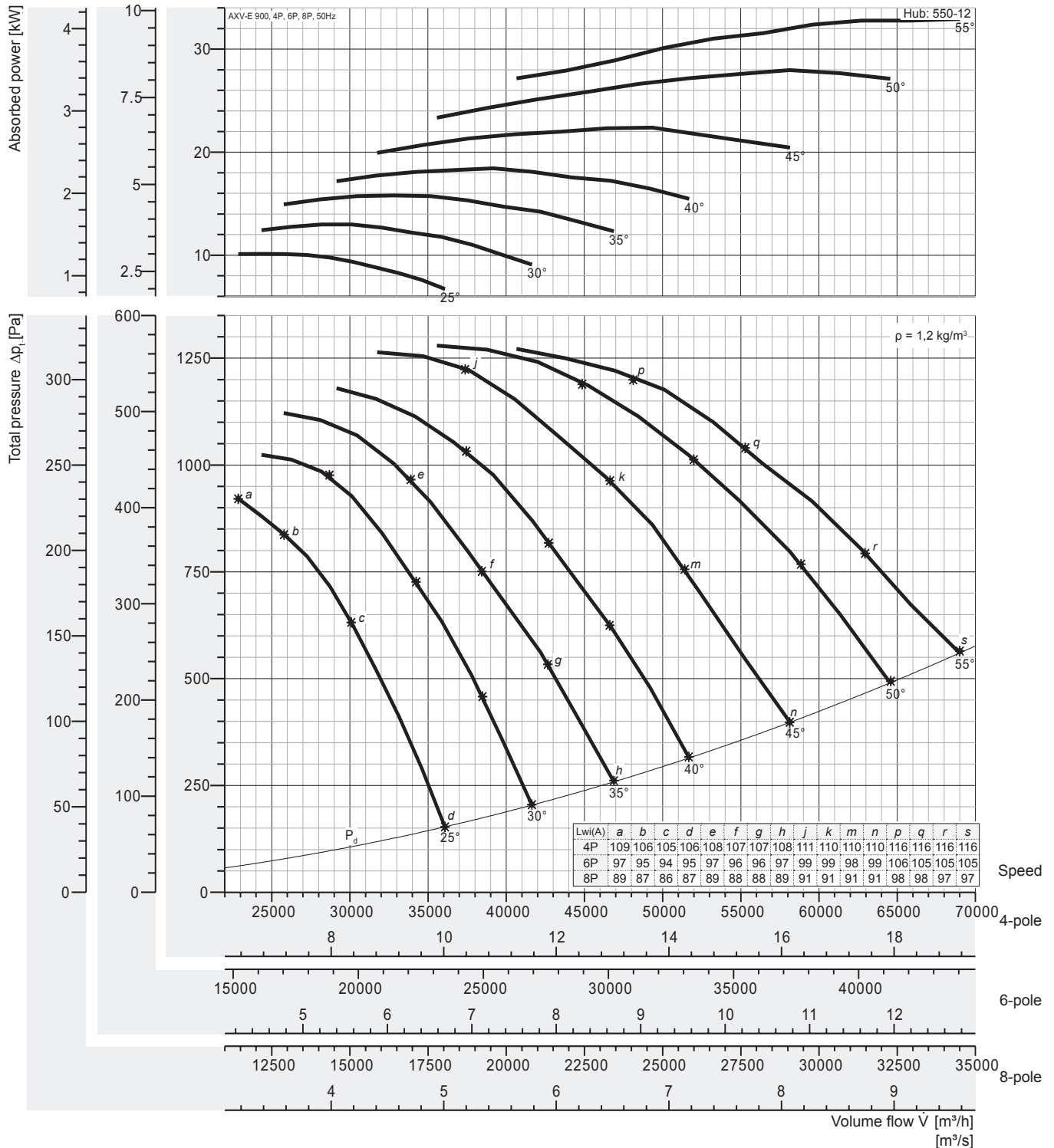

Peak absorbed power [kW]

4-pole = 1500 rpm; 6-pole = 1000 rpm; 8-pole = 750 rpm;

N Poles	Pitch angle [°]						
	25	30	35	40	45	50	55
4P motor	10,13	12,98	15,79	18,44	22,38	27,96	32,93
	11	15	18,5	30	37		
6P motor	3,00	3,85	4,68	5,46	6,63	8,28	9,76
	3	4	5,5	7,5	11		
8P motor	1,27	1,62	1,97	2,31	2,80	3,49	4,12
	1,5	2,2	3	4	5,5		

Fan test laboratory AMCA 210/99 Fig.12, Test Chamber. Performance certified is for installation type D - Ducted inlet, Ducted outlet. Performance ratings do not include the effects of appurtenances (accessories-belt cover, pulley & belt). Power rating (kW) does not include transmission losses.

The A-weighted sound ratings shown have been calculated per AMCA International Standard 301. Values shown are for inlet Lw(A) sound power levels for installation Type D: ducted inlet, ducted outlet. Ratings include the effects of duct end correction.



Performance Curve

AXV-E 1000, 50 Hz

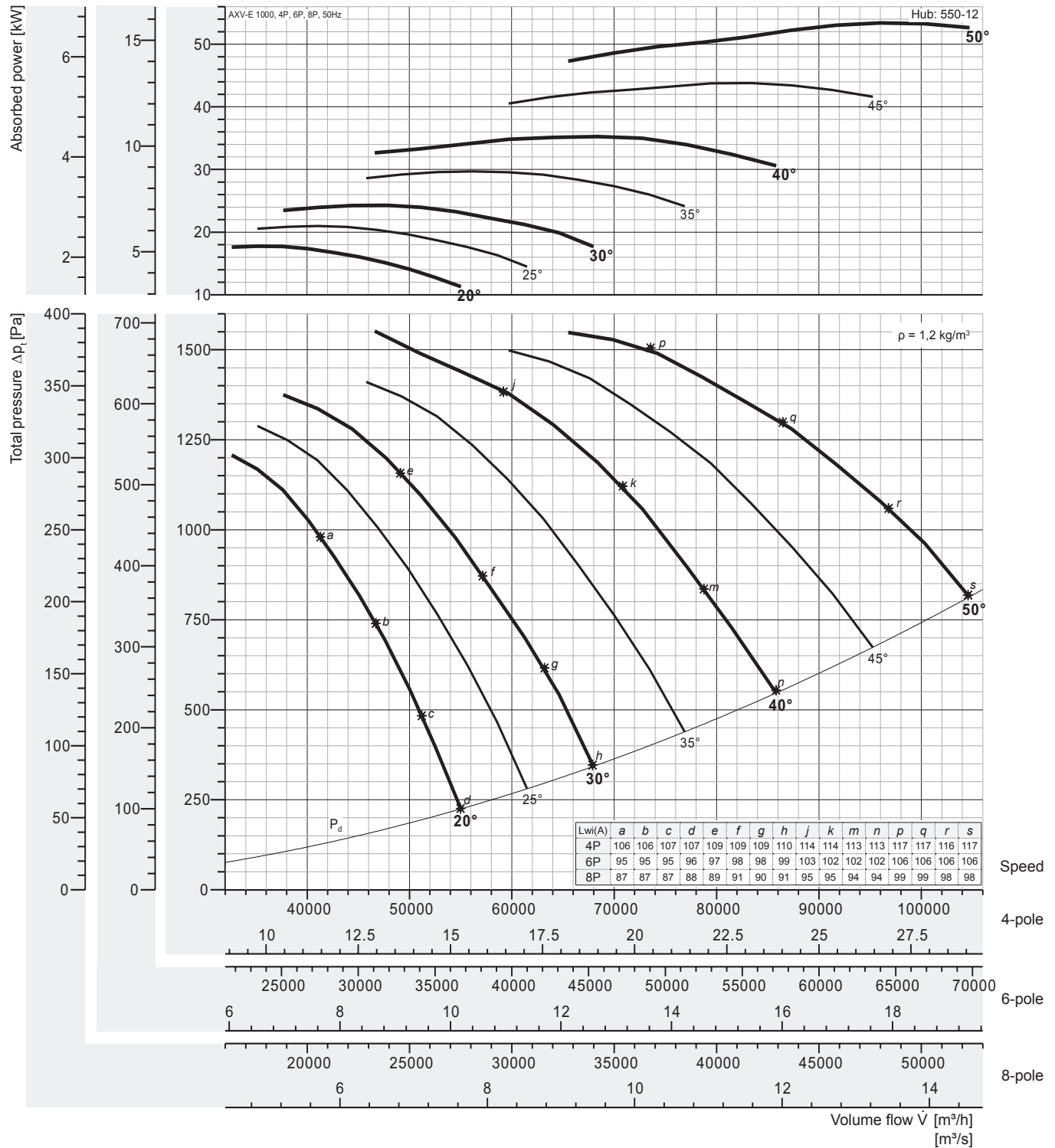

Peak absorbed power [kW]

4-pole = 1500 rpm; 6-pole = 1000 rpm; 8-pole = 750 rpm;

N Poles	Pitch angle [°]						
	20	25	30	35	40	45	50
4P motor	17,77	20,99	24,27	29,70	35,26	43,79	53,41
	18,5	22	30		37	45	55
6P motor	5,27	6,22	7,19	8,80	10,45	12,97	15,82
	5,5	7,5		11		15	18,5
8P motor	2,22	2,62	3,03	3,71	4,41	5,47	6,68
	3		4		5,5		7,5

Fan test laboratory AMCA 210/99 Fig.12, Test Chamber. Performance certified is for installation type D - Ducted inlet, Ducted outlet. Performance ratings do not include the effects of appurtenances (accessories-belt cover, pulley & belt). Power rating (kW) does not include transmission losses.

The A-weighted sound ratings shown have been calculated per AMCA International Standard 301. Values shown are for inlet Lw(A) sound power levels for installation Type D: ducted inlet, ducted outlet. Ratings include the effects of duct end correction.

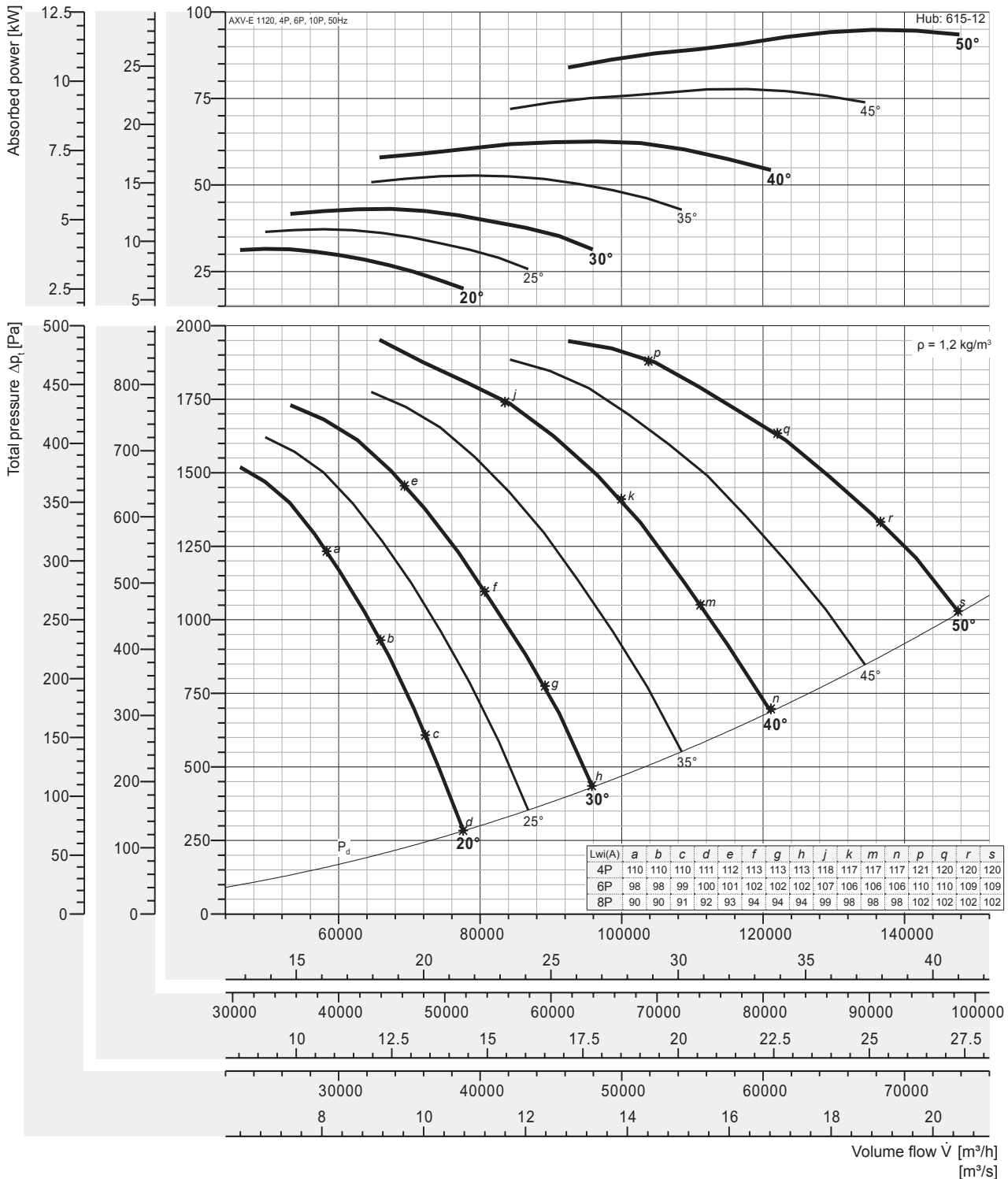

Speed
4-pole
6-pole
8-pole

Peak absorbed power [kW]

4-pole = 1500 rpm; 6-pole = 1000 rpm; 8-pole = 750 rpm;

N Poles	Pitch angle [°]						
	20	25	30	35	40	45	50
4P motor	31,55	37,26	43,09	52,73	62,59	77,74	94,81
6P motor	9,35	11,04	12,77	15,62	18,55	23,03	28,09
8P motor	3,94	4,66	5,39	6,59	7,82	9,72	11,85

Fan test laboratory AMCA 210/99 Fig.12, Test Chamber. Performance certified is for installation type D - Ducted inlet, Ducted outlet. Performance ratings do not include the effects of appurtenances (accessories-belt cover, pulley & belt). Power rating (kW) does not include transmission losses.

The A-weighted sound ratings shown have been calculated per AMCA International Standard 301. Values shown are for inlet Lw_iA sound power levels for installation Type D: ducted inlet, ducted outlet. Ratings include the effects of duct end correction.



Performance Curve

AXV-E 1250, 50 Hz

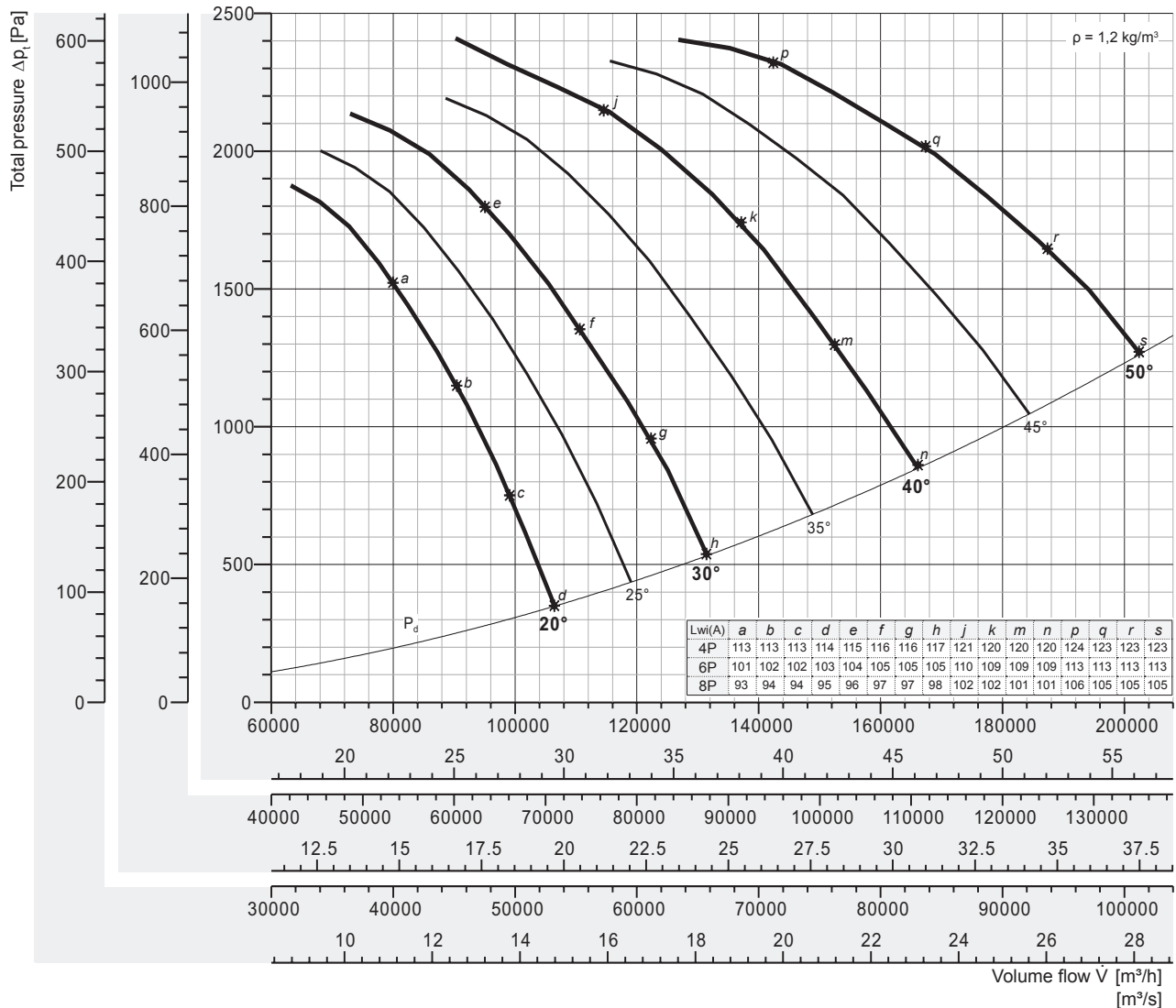
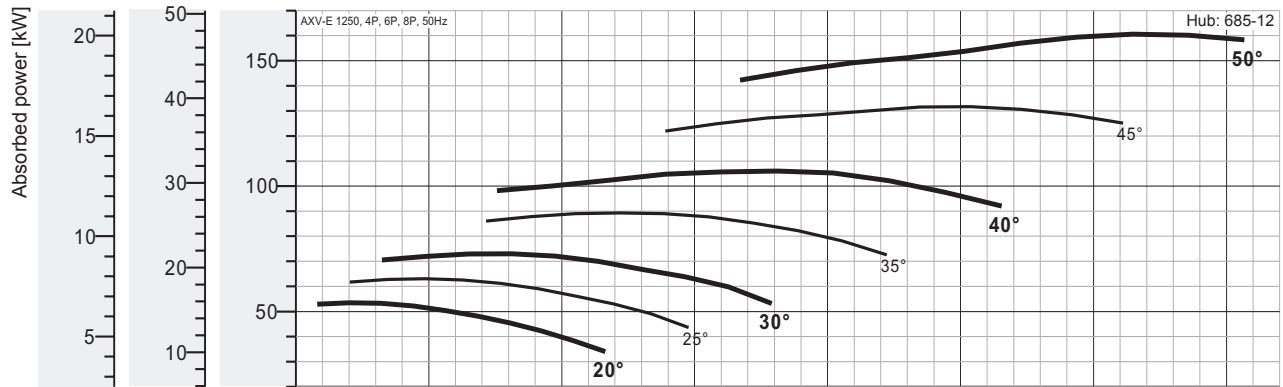

Peak absorbed power [kW]

4-pole = 1500 rpm; 6-pole = 1000 rpm; 8-pole = 750 rpm;

N Poles	Pitch angle [°]						
	20	25	30	35	40	45	50
4P motor	53,43	63,11	72,98	89,31	106,0	131,7	160,6
	55	75		90	110	132	200
6P motor	15,83	18,70	21,62	26,46	31,41	39,01	47,58
	18,5	22		30	37	45	55
8P motor	6,68	7,89	9,12	11,16	13,25	16,46	20,07
	7,5	11		15		18,5	22

Fan test laboratory AMCA 210/99 Fig.12, Test Chamber. Performance certified is for installation type D - Ducted inlet, Ducted outlet. Performance ratings do not include the effects of appurtenances (accessories-belt cover, pulley & belt). Power rating (kW) does not include transmission losses.

The A-weighted sound ratings shown have been calculated per AMCA International Standard 301. Values shown are for inlet LwiA sound power levels for installation Type D: ducted inlet, ducted outlet. Ratings include the effects of duct end correction.

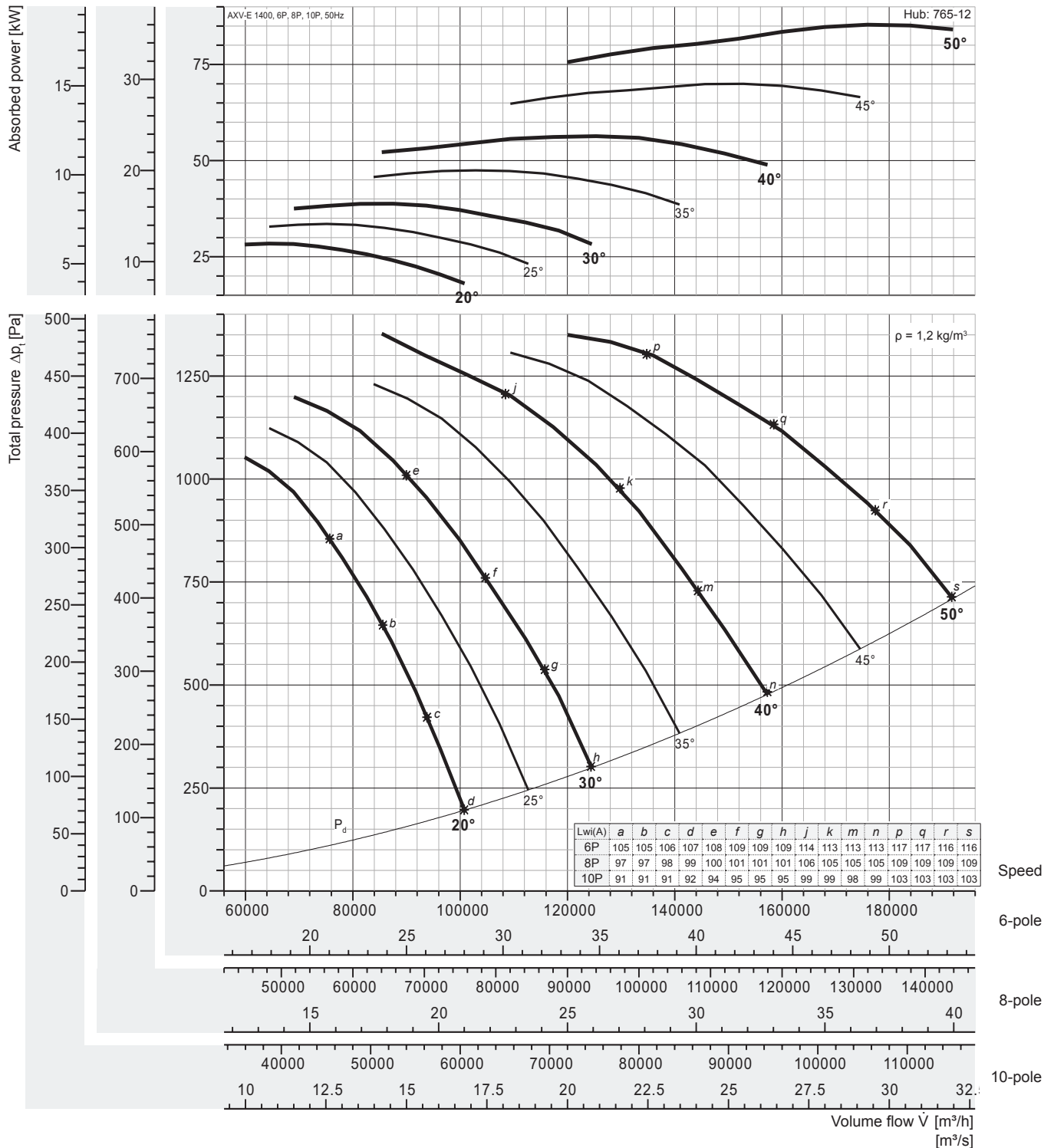

Peak absorbed power [kW]

6-pole = 1000 rpm; 8-pole = 750 rpm; 10-pole = 600 rpm;

N Poles	Pitch angle [°]						
	20	25	30	35	40	45	50
6P motor	28,40	33,54	38,79	47,47	56,35	69,98	85,35
8P motor	11,98	14,15	16,36	20,03	23,77	29,52	36,01
10P motor	6,13	7,25	8,38	10,25	12,17	15,12	18,43

Fan test laboratory AMCA 210/99 Fig.12, Test Chamber. Performance certified is for installation type D - Ducted inlet, Ducted outlet. Performance ratings do not include the effects of appurtenances (accessories-belt cover, pulley & belt). Power rating (kW) does not include transmission losses.

The A-weighted sound ratings shown have been calculated per AMCA International Standard 301. Values shown are for inlet LwiA sound power levels for installation Type D: ducted inlet, ducted outlet. Ratings include the effects of duct end correction.



Performance Curve

AXV-E 1600, 50 Hz

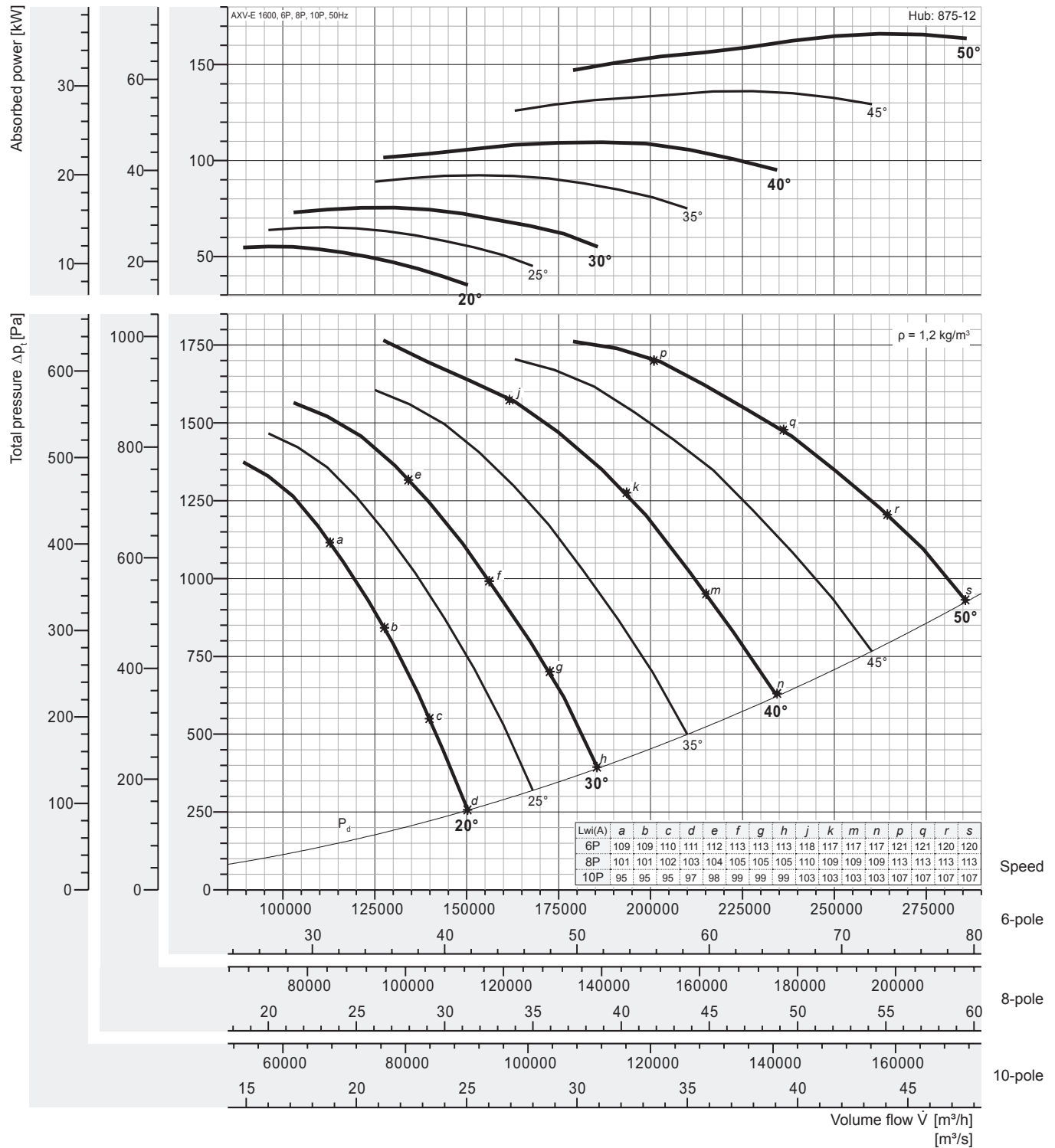

Peak absorbed power [kW]

6-pole = 1000 rpm; 8-pole = 750 rpm; 10-pole = 600 rpm;

N Poles	Pitch angle [°]						
	20	25	30	35	40	45	50
6P motor	55,24	65,26	75,45	92,34	109,6	136,1	166,0
			90	110		160	200
8P motor	23,31	27,53	31,83	38,96	46,24	57,43	70,04
			37	45	55	75	
10P motor	11,93	14,09	16,30	19,95	23,68	29,41	35,86
			18,5	22	30		37

Fan test laboratory AMCA 210/99 Fig.12, Test Chamber. Performance certified is for installation type D - Ducted inlet, Ducted outlet. Performance ratings do not include the effects of appurtenances (accessories-belt cover, pulley & belt). Power rating (kW) does not include transmission losses.

The A-weighted sound ratings shown have been calculated per AMCA International Standard 301. Values shown are for inlet Lw(A) sound power levels for installation Type D: ducted inlet, ducted outlet. Ratings include the effects of duct end correction.

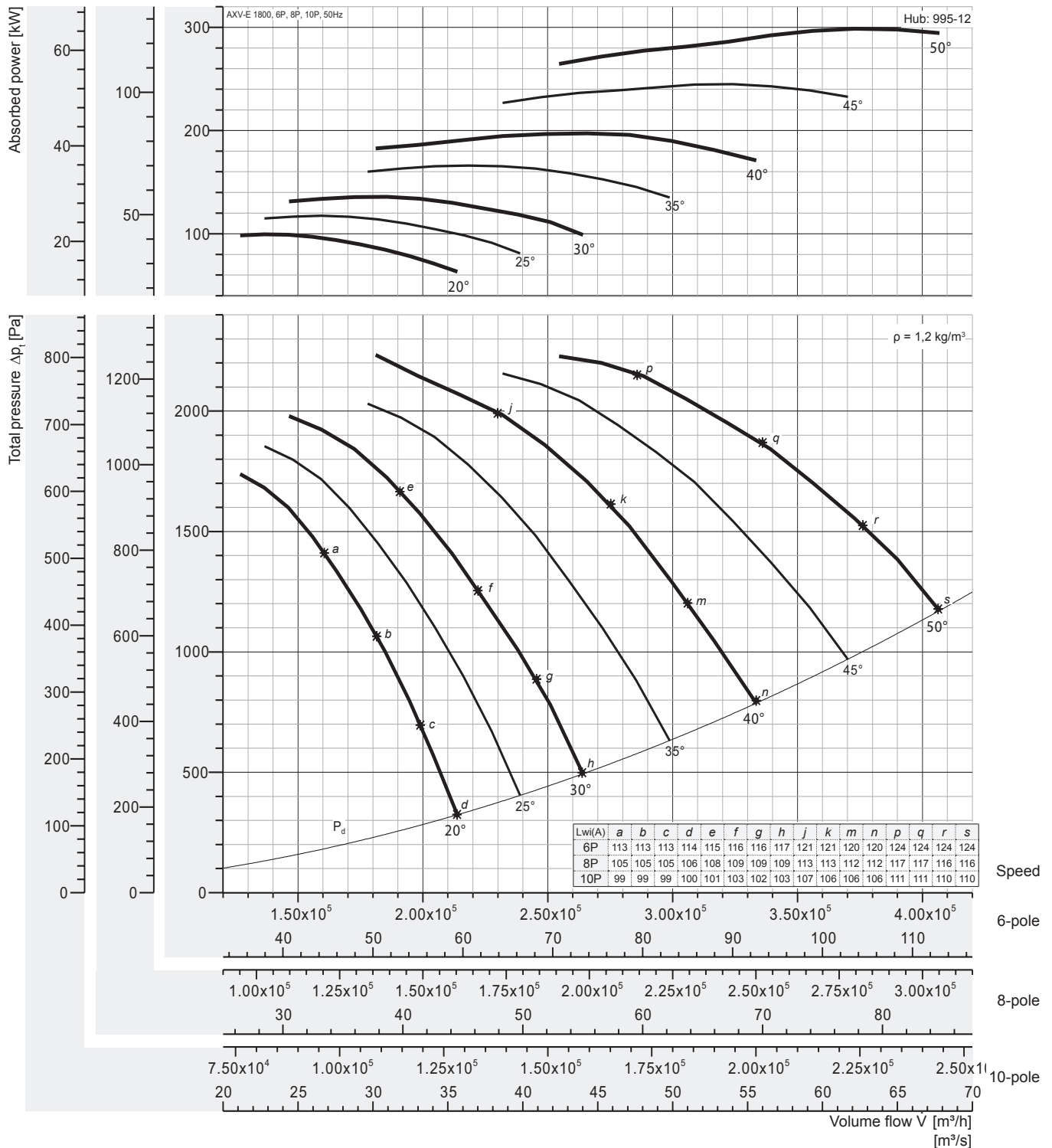

Peak absorbed power [kW]

6-pole = 1000 rpm; 8-pole = 750 rpm; 10-pole = 600 rpm;

N Poles	Pitch angle [°]						
	20	25	30	35	40	45	50
6P motor	99,37	117,4	135,7	166,1	197,2	244,9	298,7
	110	132	160	200	250	315	
8P motor	41,92	49,52	57,26	70,01	83,18	103,3	126,0
	45	55	75	90	110	132	
10P motor	21,46	25,36	29,32	35,88	42,59	52,90	64,51
	22	30	37	45	55	75	

Fan test laboratory AMCA 210/99 Fig.12, Test Chamber. Performance certified is for installation type D - Ducted inlet, Ducted outlet. Performance ratings do not include the effects of appurtenances (accessories-belt cover, pulley & belt). Power rating (kW) does not include transmission losses.

The A-weighted sound ratings shown have been calculated per AMCA International Standard 301. Values shown are for inlet LwiA sound power levels for installation Type D: ducted inlet, ducted outlet. Ratings include the effects of duct end correction.



Performance Curve

AXV-E 2000, 50 Hz

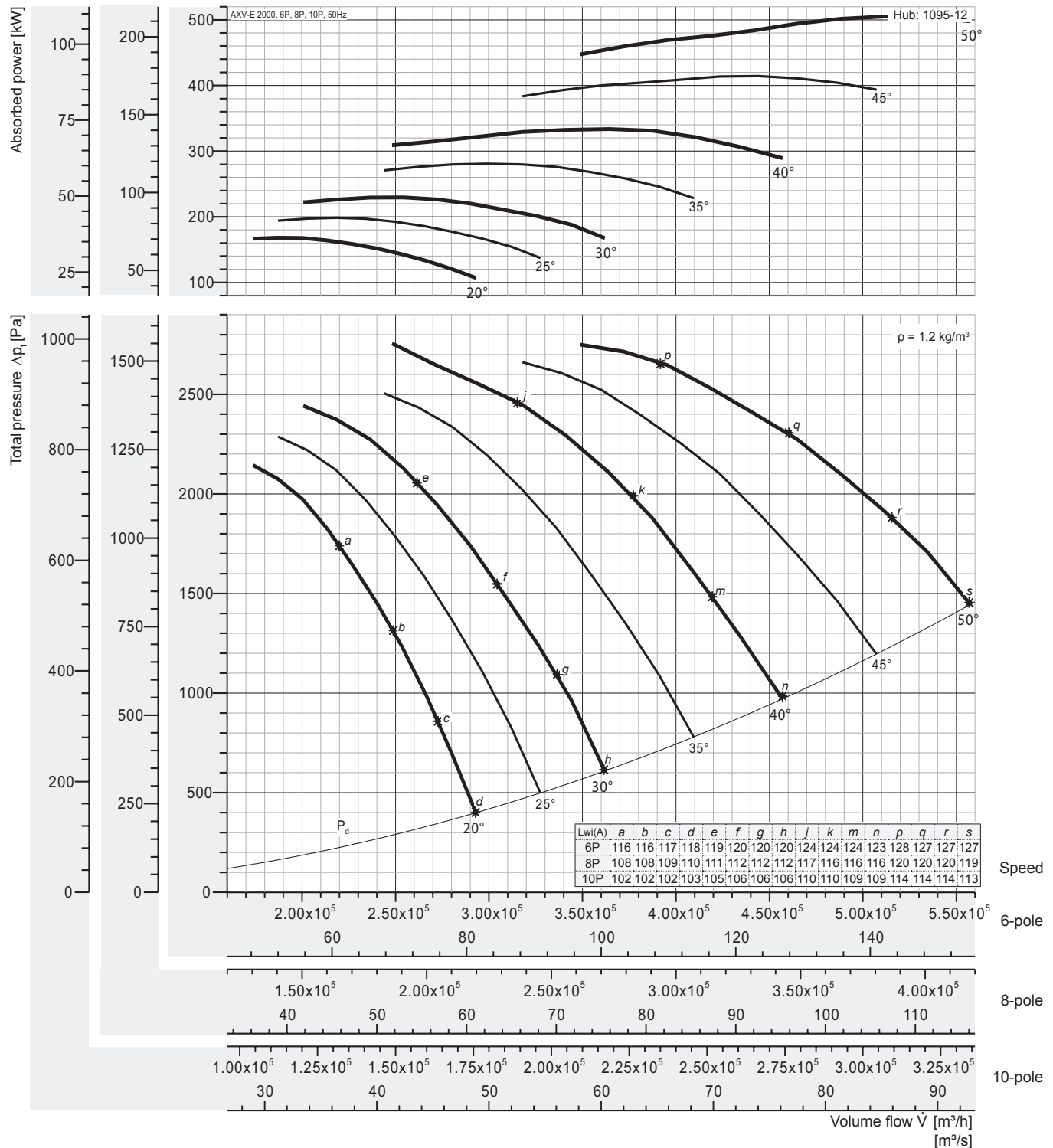

Peak absorbed power [kW]

6-pole = 1000 rpm; 8-pole = 750 rpm; 10-pole = 600 rpm;

N Poles	Pitch angle [°]						
	20	25	30	35	40	45	50
6P motor	168,1	198,5	229,5	280,9	333,4	414,1	505,1
	200		250	315	355	450	560
8P motor	70,90	83,75	96,84	118,5	140,7	174,7	213,1
	75	90	110	132	160	200	250
10P motor	36,30	42,88	49,58	60,68	72,03	89,46	109,1
	37	45	55	75		90	110

Fan test laboratory AMCA 210/99 Fig.12, Test Chamber. Performance certified is for installation type D - Ducted inlet, Ducted outlet. Performance ratings do not include the effects of appurtenances (accessories-belt cover, pulley & belt). Power rating (kW) does not include transmission losses.

The A-weighted sound ratings shown have been calculated per AMCA International Standard 301. Values shown are for inlet Lw(A) sound power levels for installation Type D: ducted inlet, ducted outlet. Ratings include the effects of duct end correction.

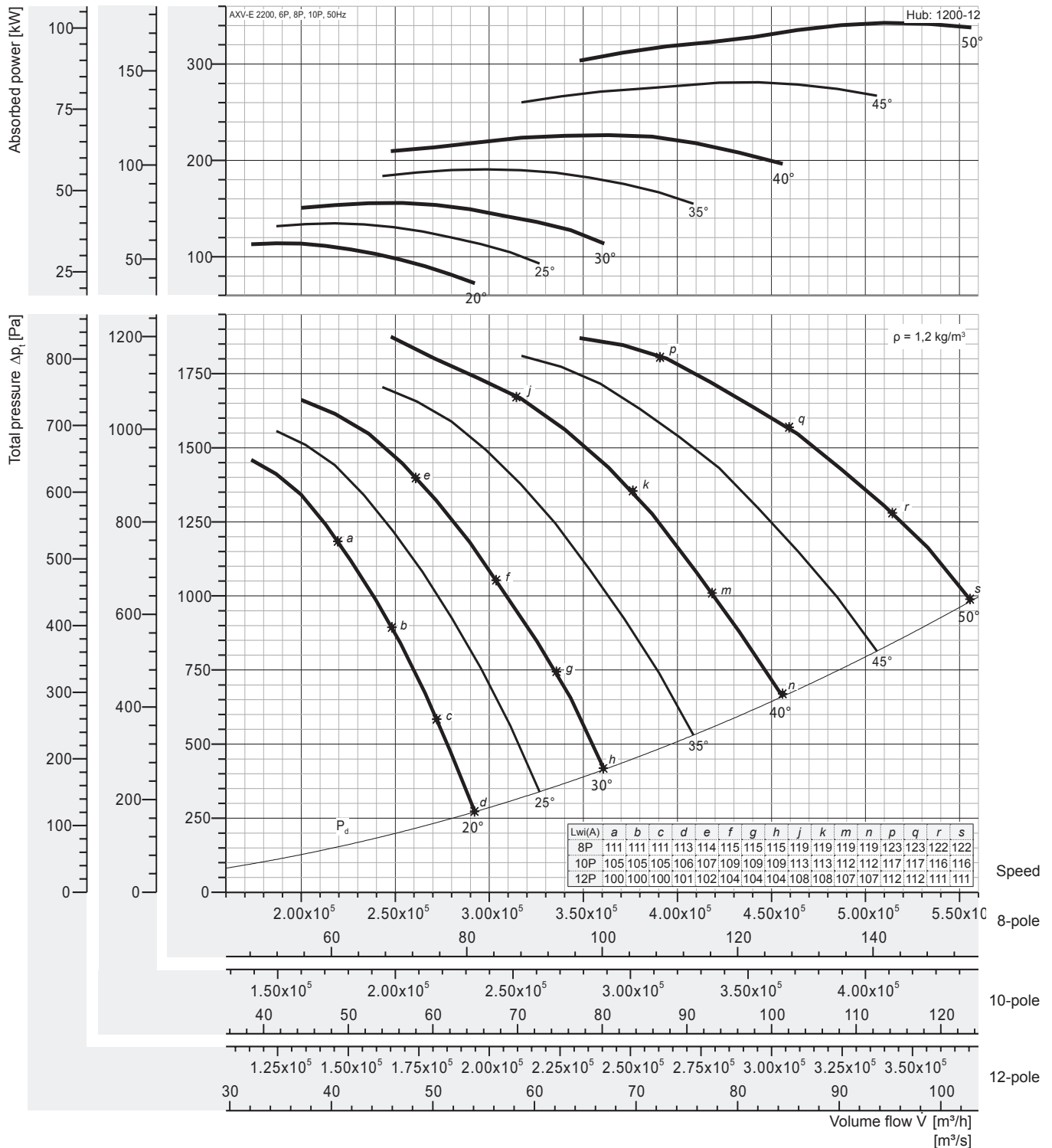

Peak absorbed power [kW]

8-pole = 750 rpm; 10-pole = 600 rpm; 12-pole = 500 rpm;

N Poles	Pitch angle [°]						
	20	25	30	35	40	45	50
8P motor	114,1	134,7	155,8	190,6	226,3	281,1	342,8
	132	160		200	250	315	355
10P motor	58,40	68,98	79,76	97,61	115,9	143,9	175,5
	75		90	110	132	160	200
12P motor	33,79	39,92	46,16	56,49	67,05	83,28	101,6
	37	45	55	75		90	110

Fan test laboratory AMCA 210/99 Fig.12, Test Chamber. Performance certified is for installation type D - Ducted inlet, Ducted outlet. Performance ratings do not include the effects of appurtenances (accessories-belt cover, pulley & belt). Power rating (kW) does not include transmission losses.

The A-weighted sound ratings shown have been calculated per AMCA International Standard 301. Values shown are for inlet LwiA sound power levels for installation Type D: ducted inlet, ducted outlet. Ratings include the effects of duct end correction.



Performance Curve

AXV-E 2400, 50 Hz

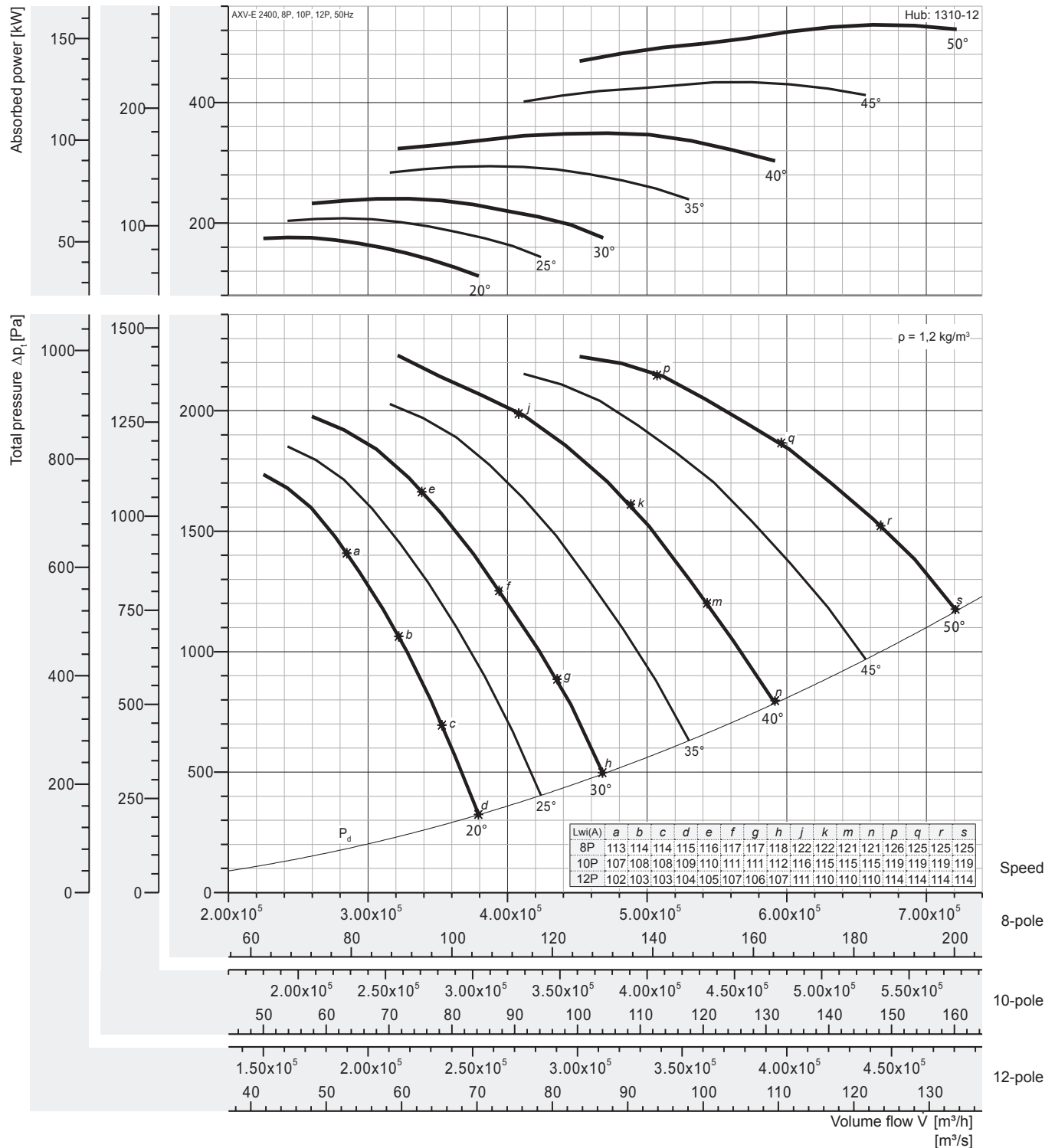

Peak absorbed power [kW]

8-pole = 750 rpm; 10-pole = 600 rpm; 12-pole = 500 rpm;

N Poles	Pitch angle [°]						
	20	25	30	35	40	45	50
8P motor	176,1	208,0	240,5	294,3	349,3	433,8	529,1
	200	250		315	355	450	560
10P motor	90,14	106,5	123,1	150,7	178,9	222,1	270,9
	110		132	160	200	250	315
12P motor	52,16	61,62	71,25	87,20	103,50	128,55	156,78
	55	75		90	110	132	160

Fan test laboratory AMCA 210/99 Fig.12, Test Chamber. Performance certified is for installation type D - Ducted inlet, Ducted outlet. Performance ratings do not include the effects of appurtenances (accessories-belt cover, pulley & belt). Power rating (kW) does not include transmission losses.

The A-weighted sound ratings shown have been calculated per AMCA International Standard 301. Values shown are for inlet Lw(A) sound power levels for installation Type D: ducted inlet, ducted outlet. Ratings include the effects of duct end correction.

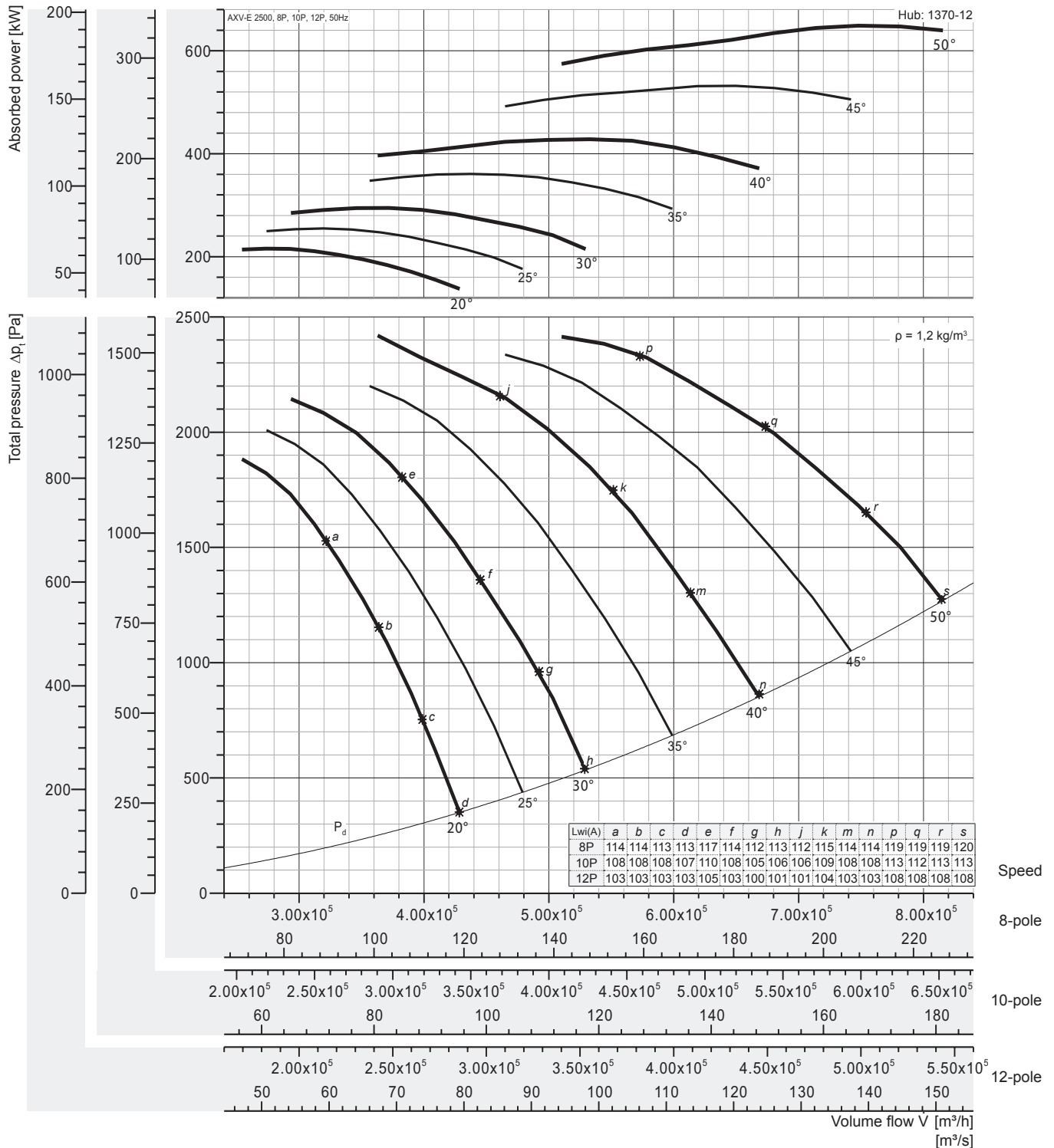

Peak absorbed power [kW]

8-pole = 750 rpm; 10-pole = 600 rpm; 12-pole = 500 rpm;

N Poles	Pitch angle [°]						
	20	25	30	35	40	45	50
8P motor	215,8	254,9	294,8	360,8	428,2	531,9	648,7
	250	315		400	450	560	710
10P motor	110,0	130,5	150,9	184,7	219,3	272,3	332,1
	110	132	160	200	250	315	355
12P motor	63,95	75,54	87,35	106,9	126,9	157,6	192,2
	75	90		110	132	160	200

Fan test laboratory AMCA 210/99 Fig.12, Test Chamber. Performance certified is for installation type D - Ducted inlet, Ducted outlet. Performance ratings do not include the effects of appurtenances (accessories-belt cover, pulley & belt). Power rating (kW) does not include transmission losses.

The A-weighted sound ratings shown have been calculated per AMCA International Standard 301. Values shown are for inlet Lw(A) sound power levels for installation Type D: ducted inlet, ducted outlet. Ratings include the effects of duct end correction.



Performance Curve

AXV-E 2600, 50 Hz

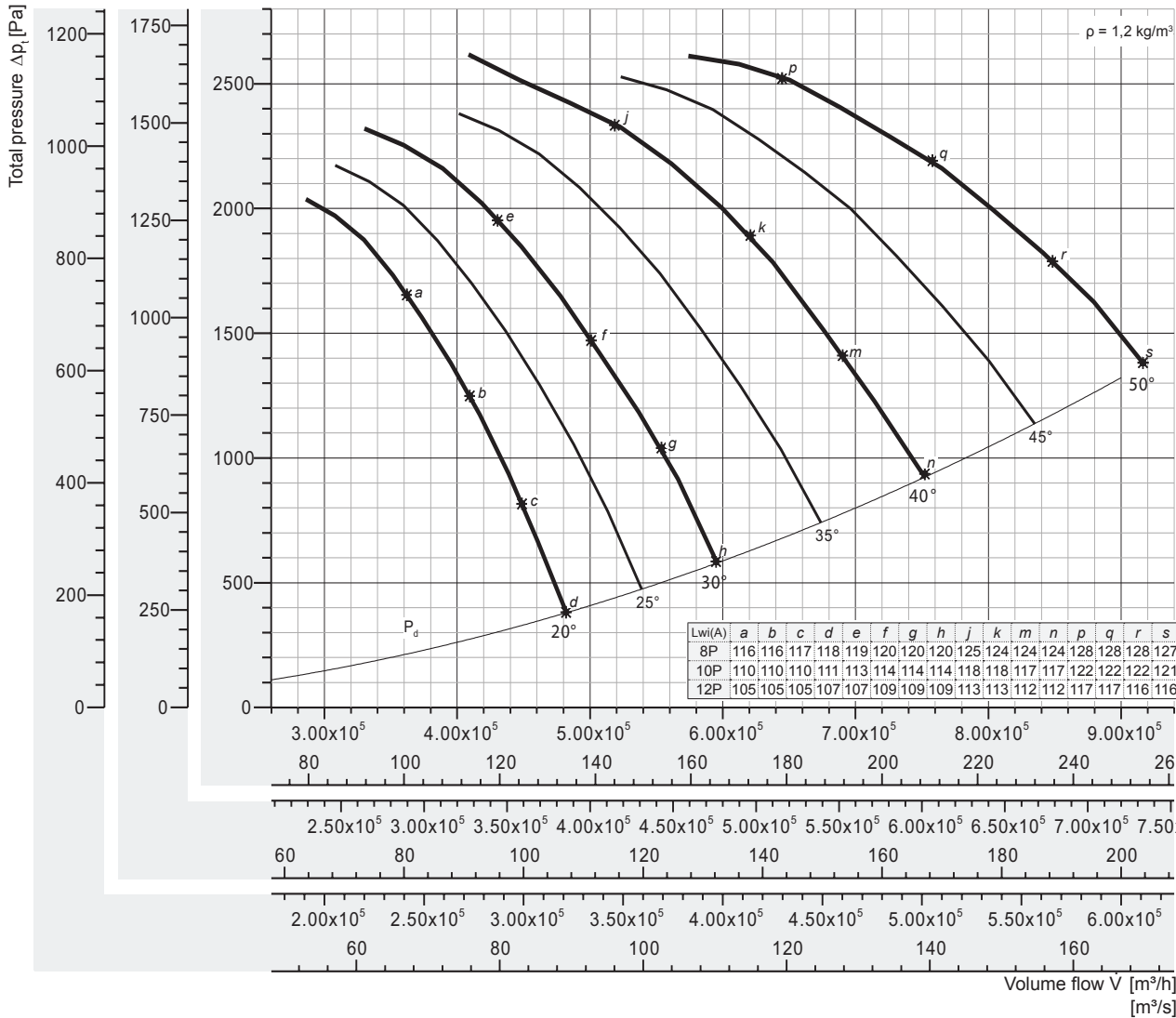
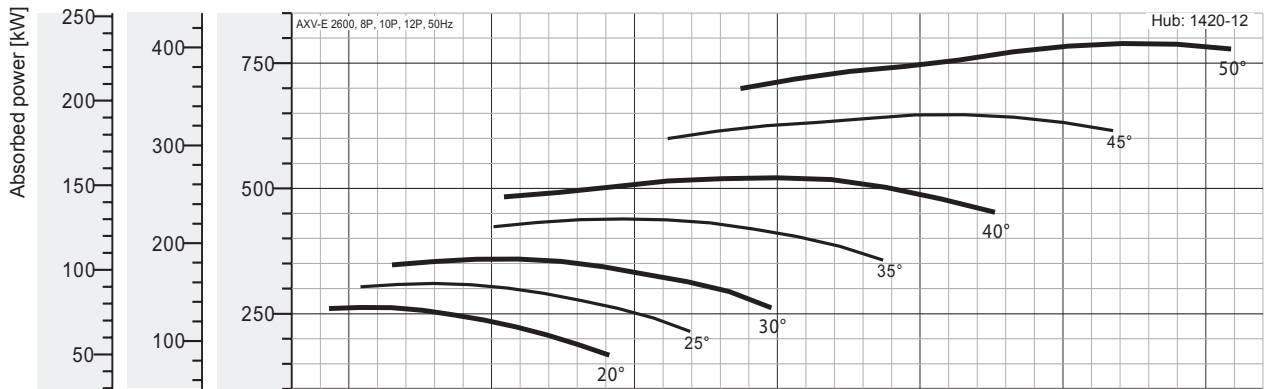

Peak absorbed power [kW]

8-pole = 750 rpm; 10-pole = 600 rpm; 12-pole = 500 rpm;

N Poles	Pitch angle [°]						
	20	25	30	35	40	45	50
8P motor	262,7	310,4	358,9	439,2	521,3	647,5	789,7
			400	450	560	710	-
10P motor	134,5	158,9	183,7	224,9	266,9	331,5	404,3
			200	250	315	355	450
12P motor	77,85	91,96	106,3	130,1	154,5	191,8	234,0
		90	110	132	160	200	250

Fan test laboratory AMCA 210/99 Fig.12, Test Chamber. Performance certified is for installation type D - Ducted inlet, Ducted outlet. Performance ratings do not include the effects of appurtenances (accessories-belt cover, pulley & belt). Power rating (kW) does not include transmission losses.

The A-weighted sound ratings shown have been calculated per AMCA International Standard 301. Values shown are for inlet Lw(A) sound power levels for installation Type D: ducted inlet, ducted outlet. Ratings include the effects of duct end correction.

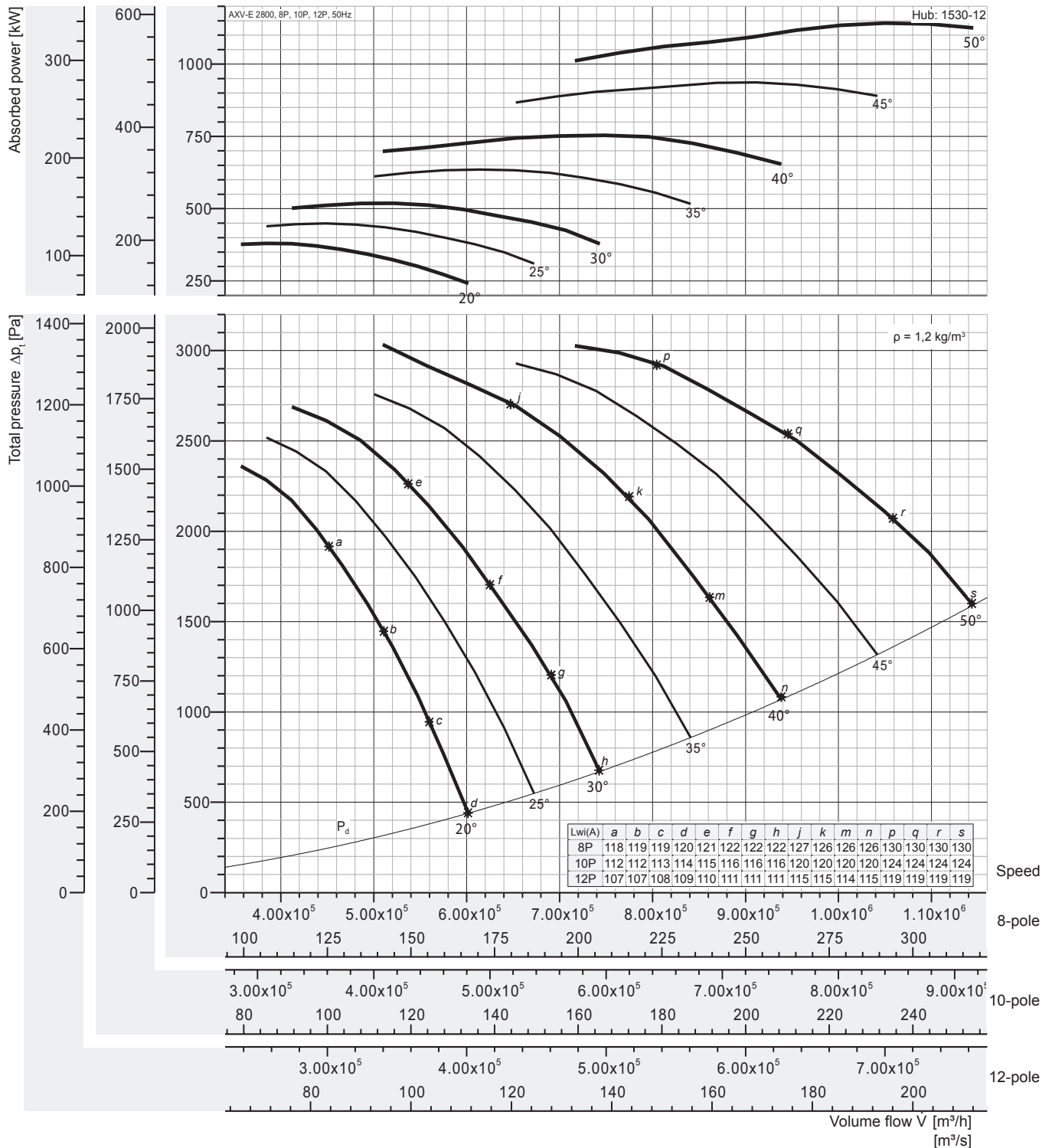

Peak absorbed power [kW]

8-pole = 750 rpm; 10-pole = 600 rpm; 12-pole = 500 rpm;

N Poles	Pitch angle [°]						
	20	25	30	35	40	45	50
8P motor	380,0 400	448,8 450	519,0 560	635,1 710	753,9 -	936,3 -	1142 -
10P motor	194,5 200	229,8 250	265,7 315	325,2 355	386,0 400	479,4 560	584,7 630
12P motor	112,6 132	133,0 160	153,8	188,2 200	223,4 250	277,4 315	338,4 355

Fan test laboratory AMCA 210/99 Fig.12, Test Chamber. Performance certified is for installation type D - Ducted inlet, Ducted outlet. Performance ratings do not include the effects of appurtenances (accessories-belt cover, pulley & belt). Power rating (kW) does not include transmission losses.

The A-weighted sound ratings shown have been calculated per AMCA International Standard 301. Values shown are for inlet Lw(A) sound power levels for installation Type D: ducted inlet, ducted outlet. Ratings include the effects of duct end correction.



Certified FEGs are determined in accordance with AMCA 205-12 Energy Efficiency Classification for fans. In conjunction with AMCA 211-05 (Rev. 6/12) Certified Ratings Program, Product Rating Manual for Fan Air Performance. This classification is based on fan peak (optimum) total efficiency for a given fan speed, fan size and application category. For the purpose of energy classification, the peak efficiency can be determined at a speed not higher than the maximum design speed of the fan.

The AMCA Certified Ratings Seal applies to the Fan Efficiency Grade (FEG) for AXV-E series Axial Fan model AXV-E 800 to AXV-E 2800 as shown in the table below.

Fan Model No.	Fan Speed (rpm)	Fan Outlet Area (m2)	Fan Efficiency Grades	Fan Model No.	Fan Speed (rpm)	Fan Outlet Area (m2)	Fan Efficiency Grade
AXV-E 800	1800/1200/900	0,4989	FEG60	AXV-E 1800	1200/900/720	2,5588	FEG67
AXV-E 900	1800/1200/900	0,6277	FEG63	AXV-E 2000	1200/900/720	3,1573	FEG67
AXV-E 1000	1800/1200/900	0,7901	FEG67	AXV-E 2200	900/720/600	3,8186	FEG67
AXV-E 1120	1800/1200/900	0,9940	FEG67	AXV-E 2400	900/720/600	4,5428	FEG67
AXV-E 1250	1800/1200/900	1,2272	FEG67	AXV-E 2500	900/720/600	4,9284	FEG67
AXV-E 1400	1200/900/720	1,5504	FEG67	AXV-E 2600	900/720/600	5,3297	FEG67
AXV-E 1600	1200/900/720	2,0232	FEG67	AXV-E 2800	900/720/600	6,1795	FEG67

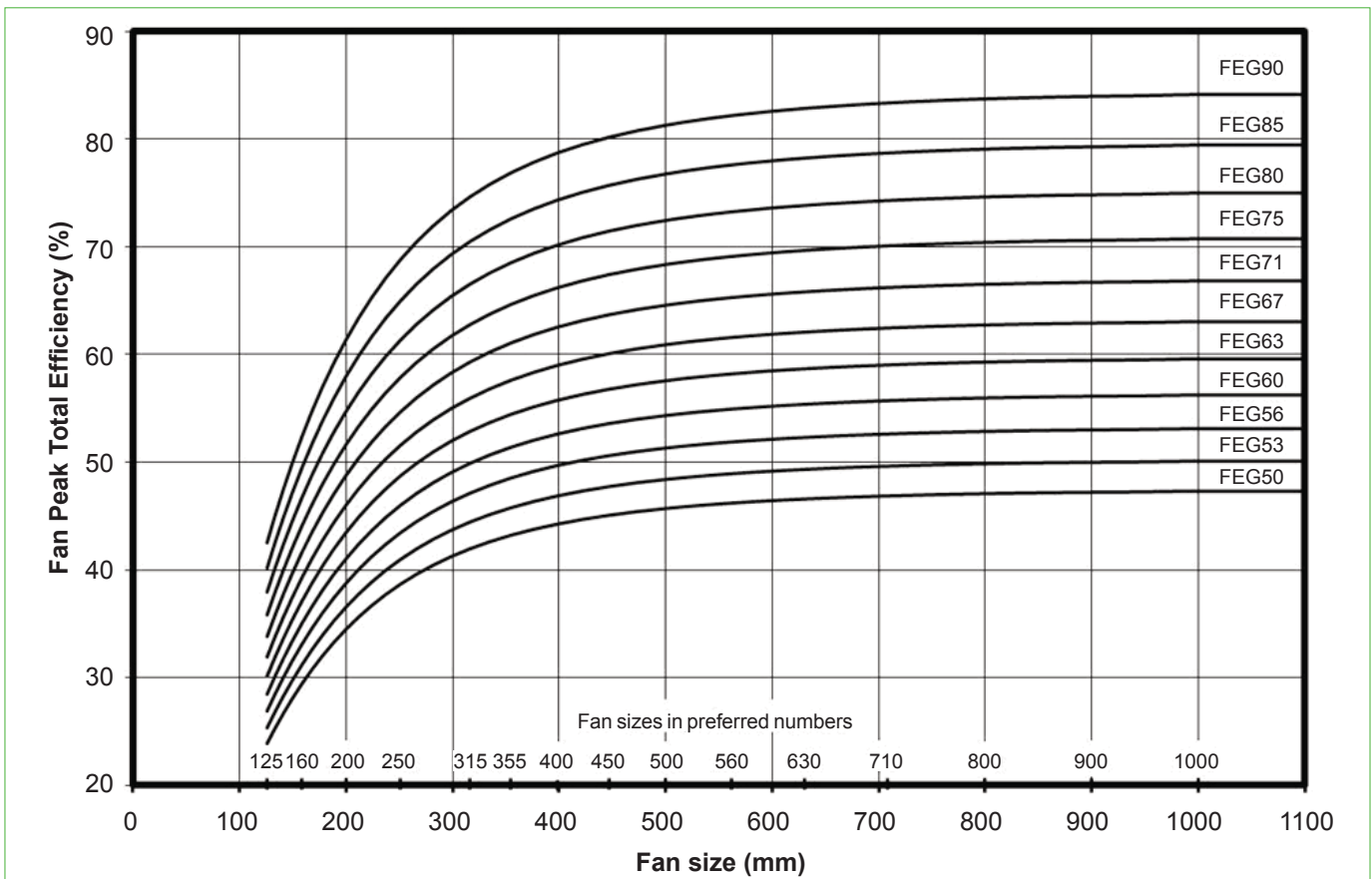

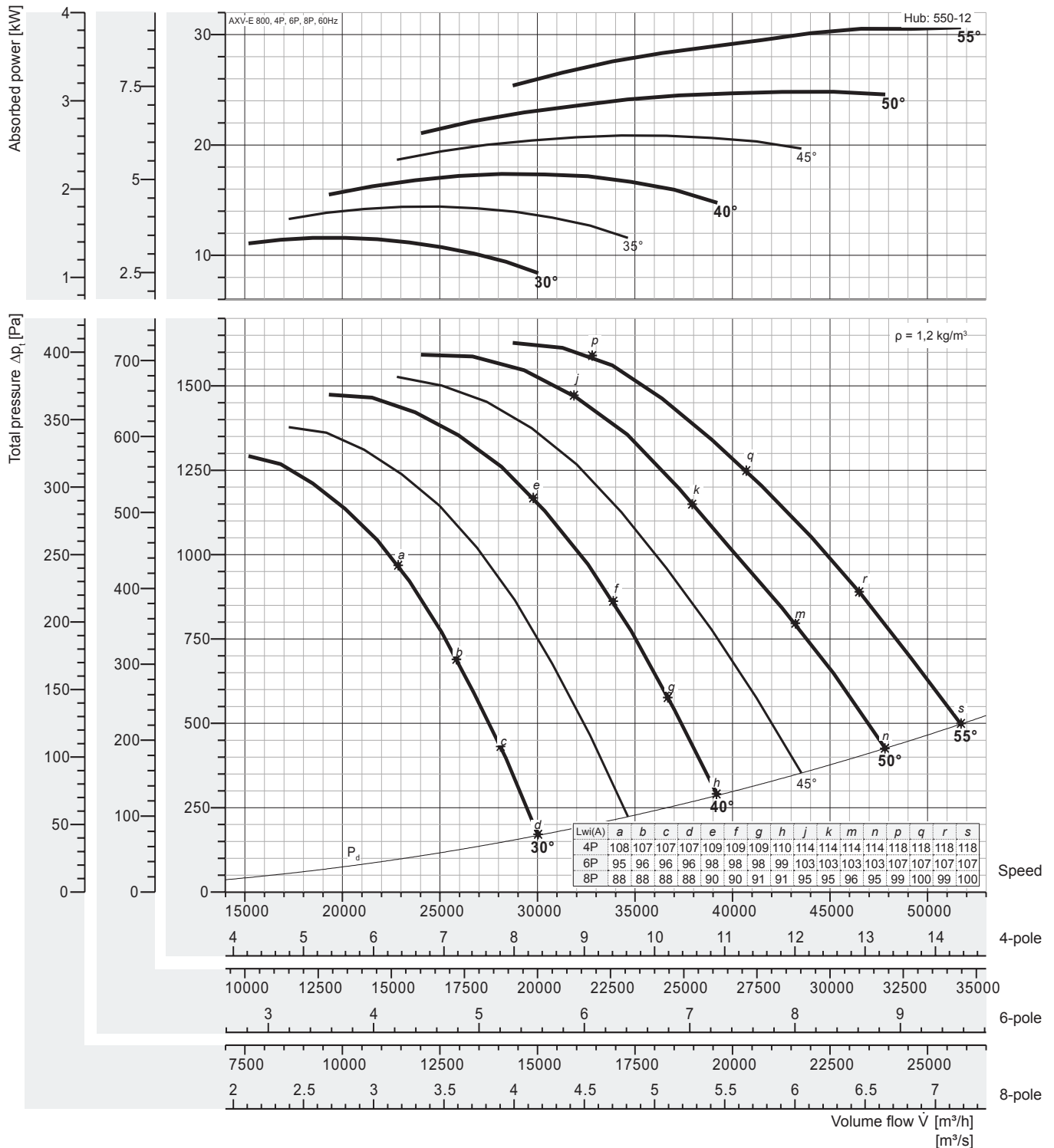

Peak absorbed power [kW]

4-pole = 1800 rpm; 6-pole = 1200 rpm; 8-pole = 900 rpm;

N Poles	Pitch angle [°]						
	25	30	35	40	45	50	55
4P	-	11,58	14,42	17,37	20,86	24,82	30,65
Motor	-	15		18,5	22	30	37
6P	-	3,43	4,27	5,15	6,18	7,35	9,08
Motor	-	4	5,5	7,5			11
8P	-	1,45	1,80	2,17	2,61	3,10	3,83
Motor	-	1,5	2,2		3	4	

Fan test laboratory AMCA 210/99 Fig.12, Test Chamber. Performance certified is for installation type D - Ducted inlet, Ducted outlet. Performance ratings do not include the effects of appurtenances (accessories-belt cover, pulley & belt). Power rating (kW) does not include transmission losses.

The A-weighted sound ratings shown have been calculated per AMCA International Standard 301. Values shown are for inlet Lw_iA sound power levels for installation Type D: ducted inlet, ducted outlet. Ratings include the effects of duct end correction.



Performance Curve

AXV-E 900, 60 Hz

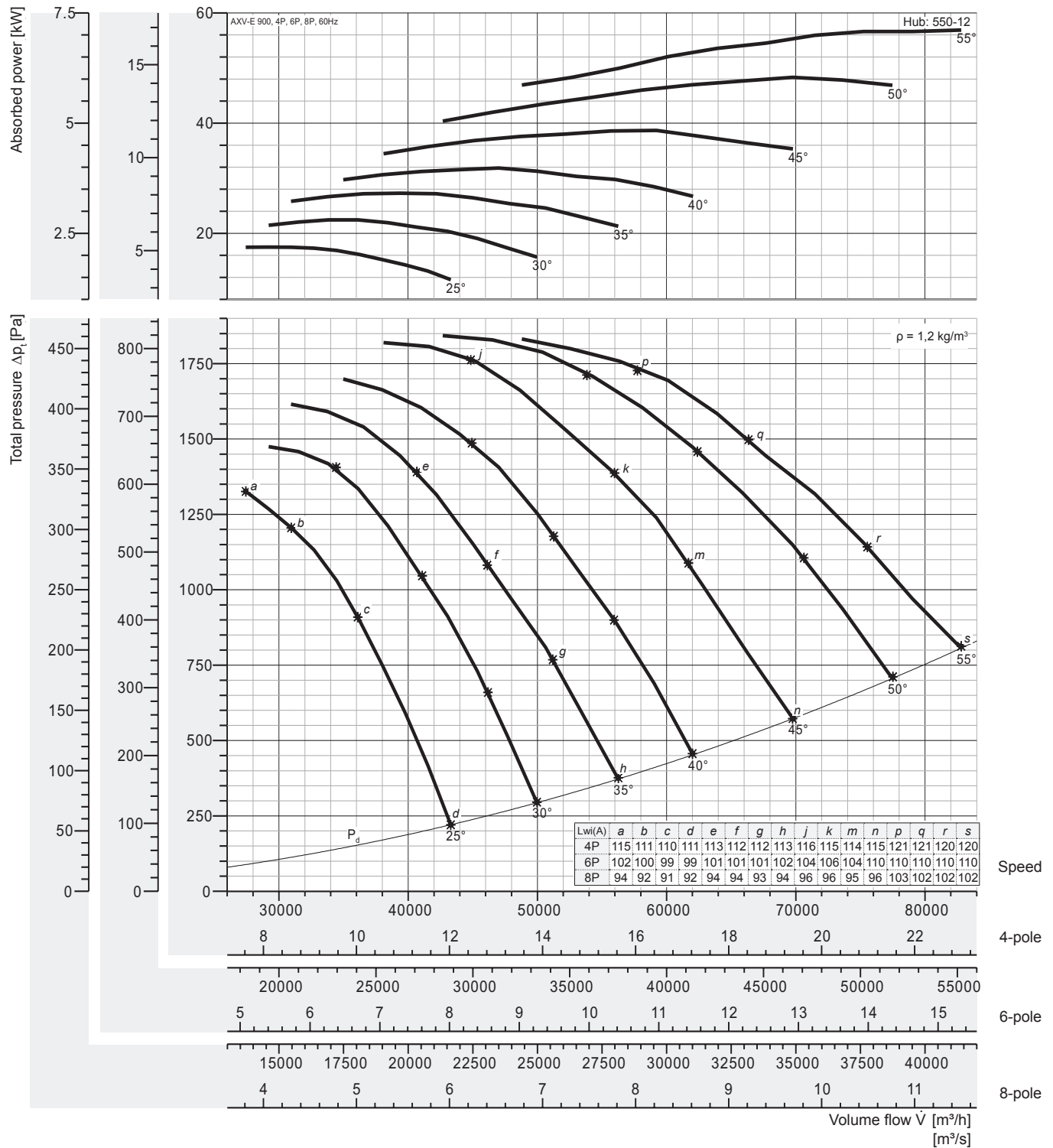

Peak absorbed power [kW]

4-pole = 1800 rpm; 6-pole = 1200 rpm; 8-pole = 900 rpm;

N Poles	Pitch angle [°]						
	25	30	35	40	45	50	55
4P motor	17,51	22,43	27,29	31,86	38,67	48,32	56,90
6P motor	5,19	6,65	8,08	9,44	11,46	14,32	16,86
8P motor	2,19	2,80	3,41	3,98	4,83	6,04	7,11

Fan test laboratory AMCA 210/99 Fig.12, Test Chamber. Performance certified is for installation type D - Ducted inlet, Ducted outlet. Performance ratings do not include the effects of appurtenances (accessories-belt cover, pulley & belt). Power rating (kW) does not include transmission losses.

The A-weighted sound ratings shown have been calculated per AMCA International Standard 301. Values shown are for inlet Lw(A) sound power levels for installation Type D: ducted inlet, ducted outlet. Ratings include the effects of duct end correction.

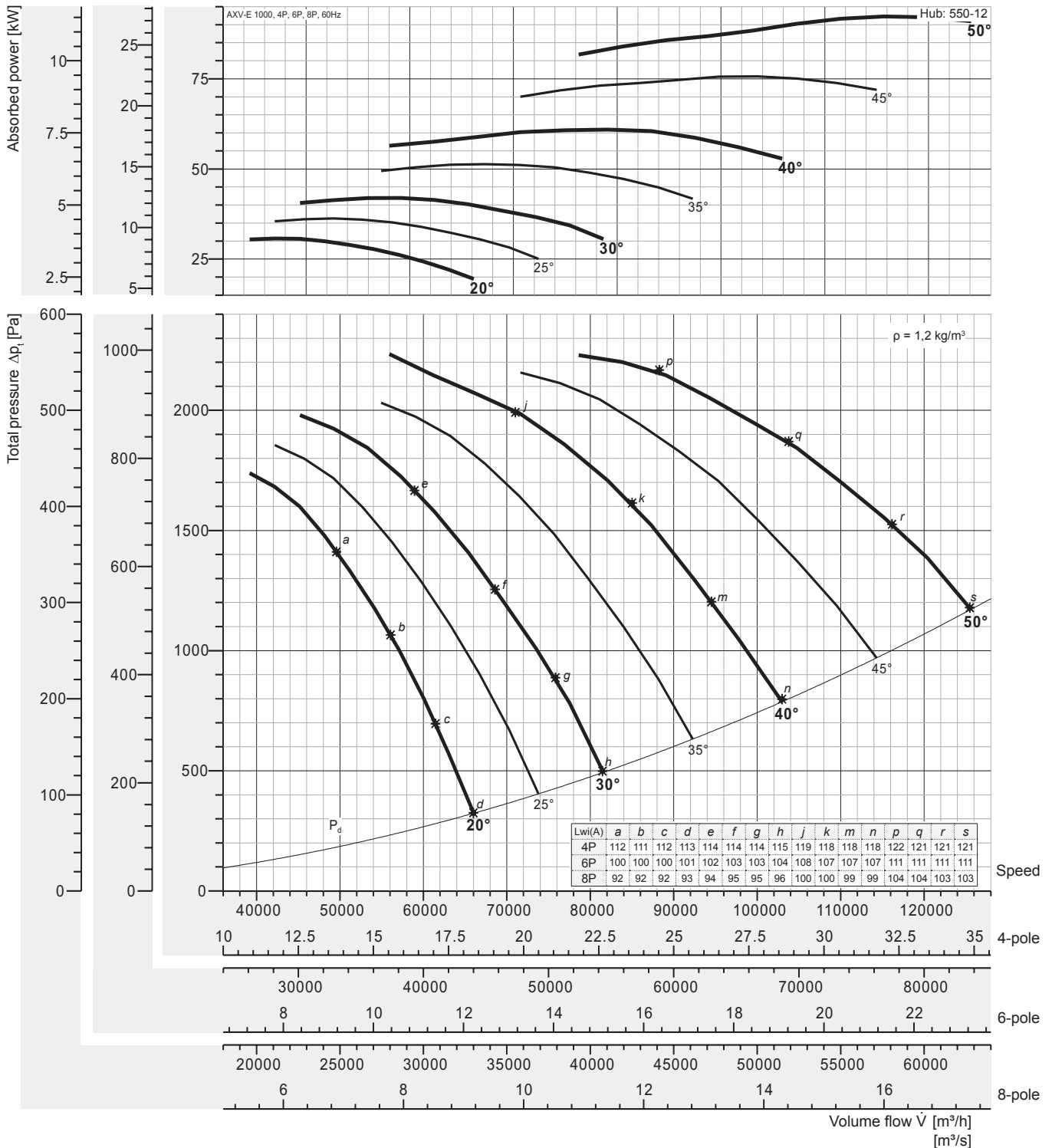

Peak absorbed power [kW]

4-pole = 1800 rpm; 6-pole = 1200 rpm; 8-pole = 900 rpm;

N Poles	Pitch angle [°]						
	20	25	30	35	40	45	50
4P motor	30,71	36,27	41,94	51,33	60,92	75,67	92,28
	37		45	55	75	90	110
6P motor	9,10	10,75	12,43	15,21	18,05	22,42	27,34
	11		15	18,5		30	
8P motor	3,84	4,53	5,24	6,42	7,62	9,46	11,54
	4	5,5		7,5	11		15

Fan test laboratory AMCA 210/99 Fig.12, Test Chamber. Performance certified is for installation type D - Ducted inlet, Ducted outlet. Performance ratings do not include the effects of appurtenances (accessories-belt cover, pulley & belt). Power rating (kW) does not include transmission losses.

The A-weighted sound ratings shown have been calculated per AMCA International Standard 301. Values shown are for inlet Lw(A) sound power levels for installation Type D: ducted inlet, ducted outlet. Ratings include the effects of duct end correction.



Performance Curve

AXV-E 1120, 60 Hz

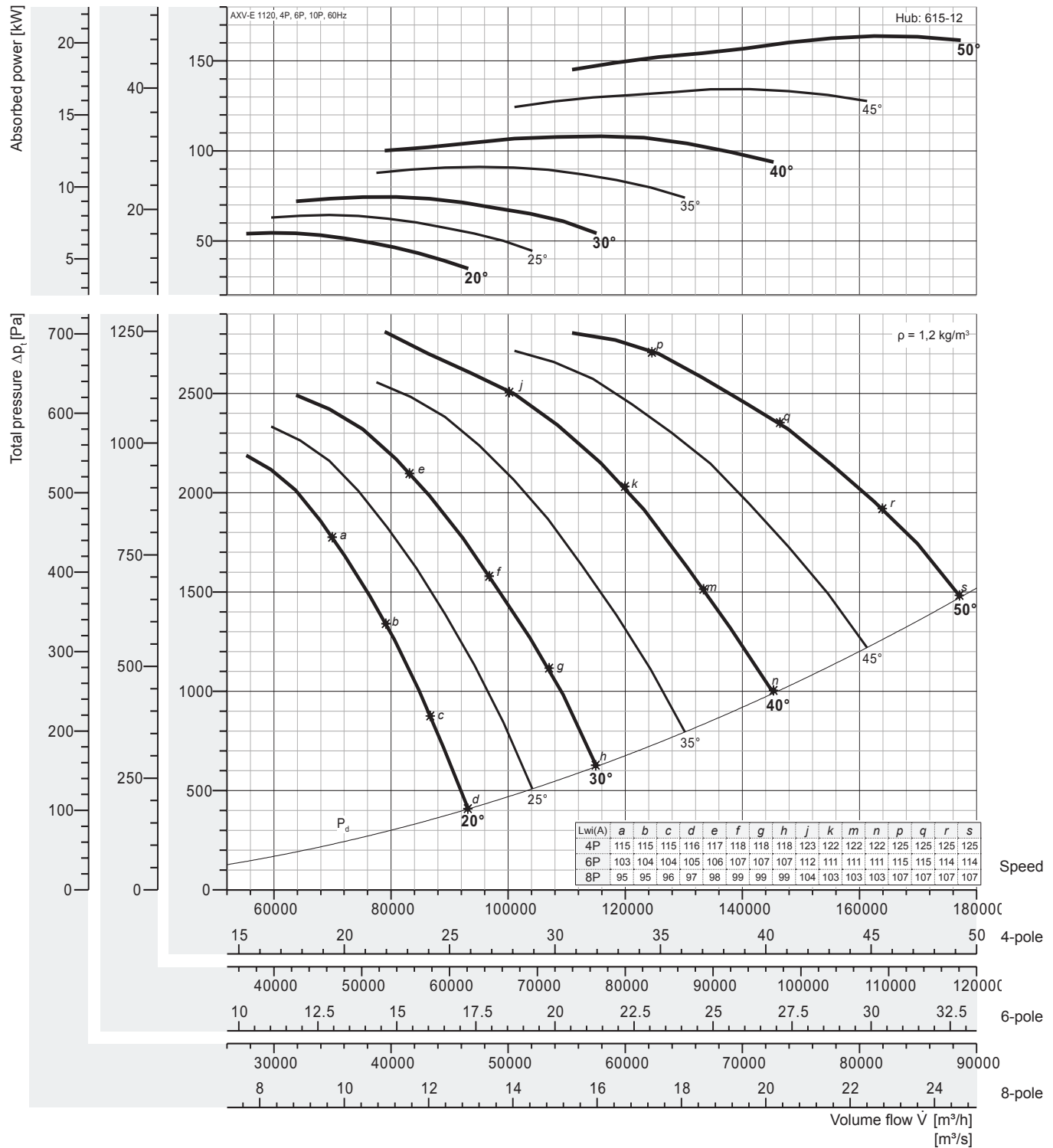

Peak absorbed power [kW]

4-pole = 1800 rpm; 6-pole = 1200 rpm; 8-pole = 900 rpm;

N Poles	Pitch angle [°]						
	20	25	30	35	40	45	50
4P motor	54,51	64,39	74,46	91,12	108,2	134,3	163,8
	55	75		110		160	200
6P motor	16,15	19,08	22,06	27,00	32,05	39,80	48,54
	18,5	22	30		37	45	55
8P motor	6,81	8,05	9,31	11,39	13,52	16,79	20,48
	7,5	11		15		18,5	22

Fan test laboratory AMCA 210/99 Fig.12, Test Chamber. Performance certified is for installation type D - Ducted inlet, Ducted outlet. Performance ratings do not include the effects of appurtenances (accessories-belt cover, pulley & belt). Power rating (kW) does not include transmission losses.

The A-weighted sound ratings shown have been calculated per AMCA International Standard 301. Values shown are for inlet Lw(A) sound power levels for installation Type D: ducted inlet, ducted outlet. Ratings include the effects of duct end correction.

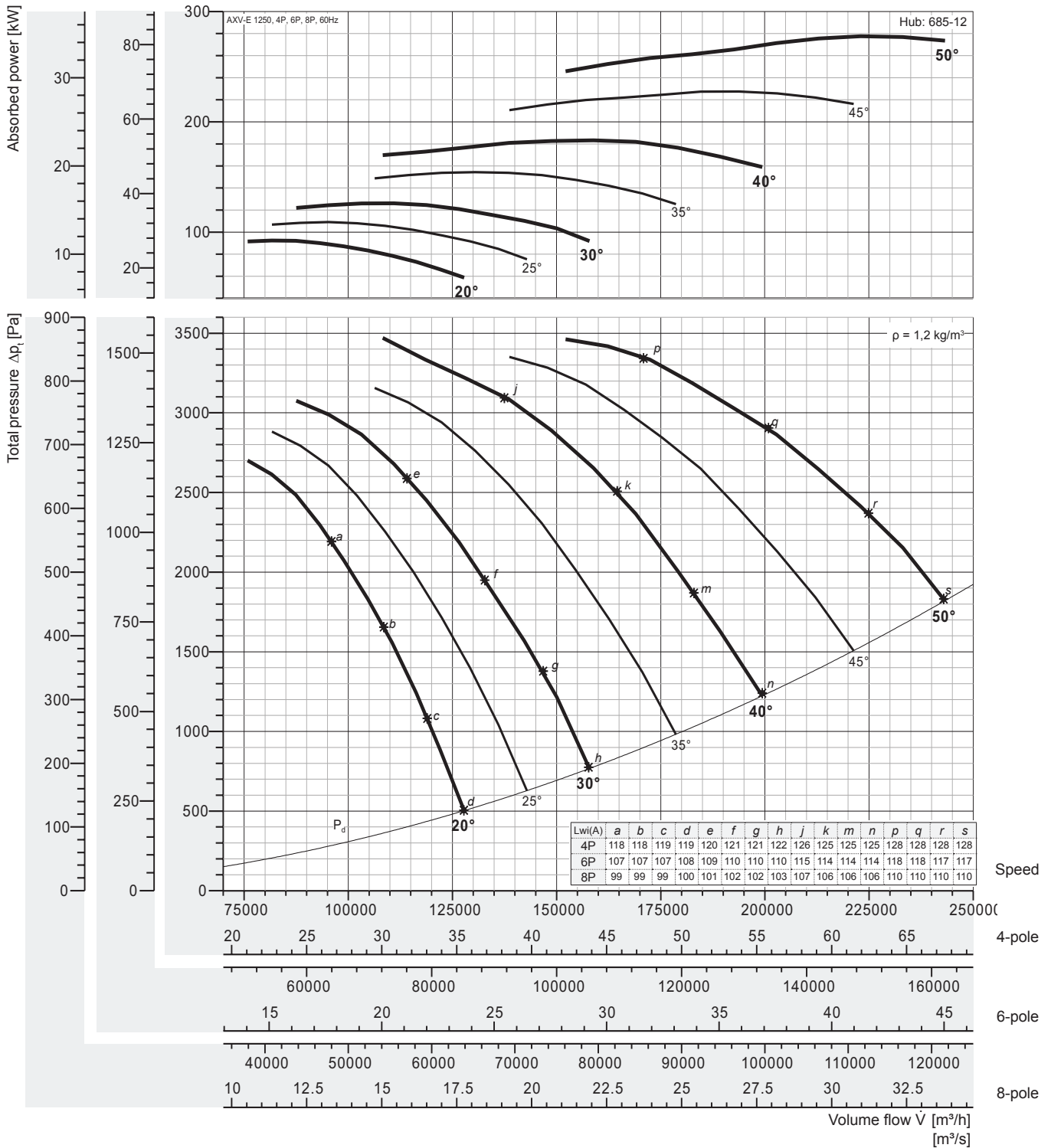

Peak absorbed power [kW]

4-pole = 1800 rpm; 6-pole = 1200 rpm; 8-pole = 900 rpm;

N Poles	Pitch angle [°]						
	20	25	30	35	40	45	50
4P motor	92,32	109,1	126,1	154,3	183,2	227,5	277,5
	110		132	160	200	250	315
6P motor	27,36	32,31	37,36	45,73	54,28	67,41	82,22
	30	37	45	55		75	90
8P motor	11,54	13,63	15,76	19,29	22,90	28,44	34,68
	15		18,5	22	30		37

Fan test laboratory AMCA 210/99 Fig.12, Test Chamber. Performance certified is for installation type D - Ducted inlet, Ducted outlet. Performance ratings do not include the effects of appurtenances (accessories-belt cover, pulley & belt). Power rating (kW) does not include transmission losses.

The A-weighted sound ratings shown have been calculated per AMCA International Standard 301. Values shown are for inlet Lw(A) sound power levels for installation Type D: ducted inlet, ducted outlet. Ratings include the effects of duct end correction.



Performance Curve

AXV-E 1400, 60 Hz

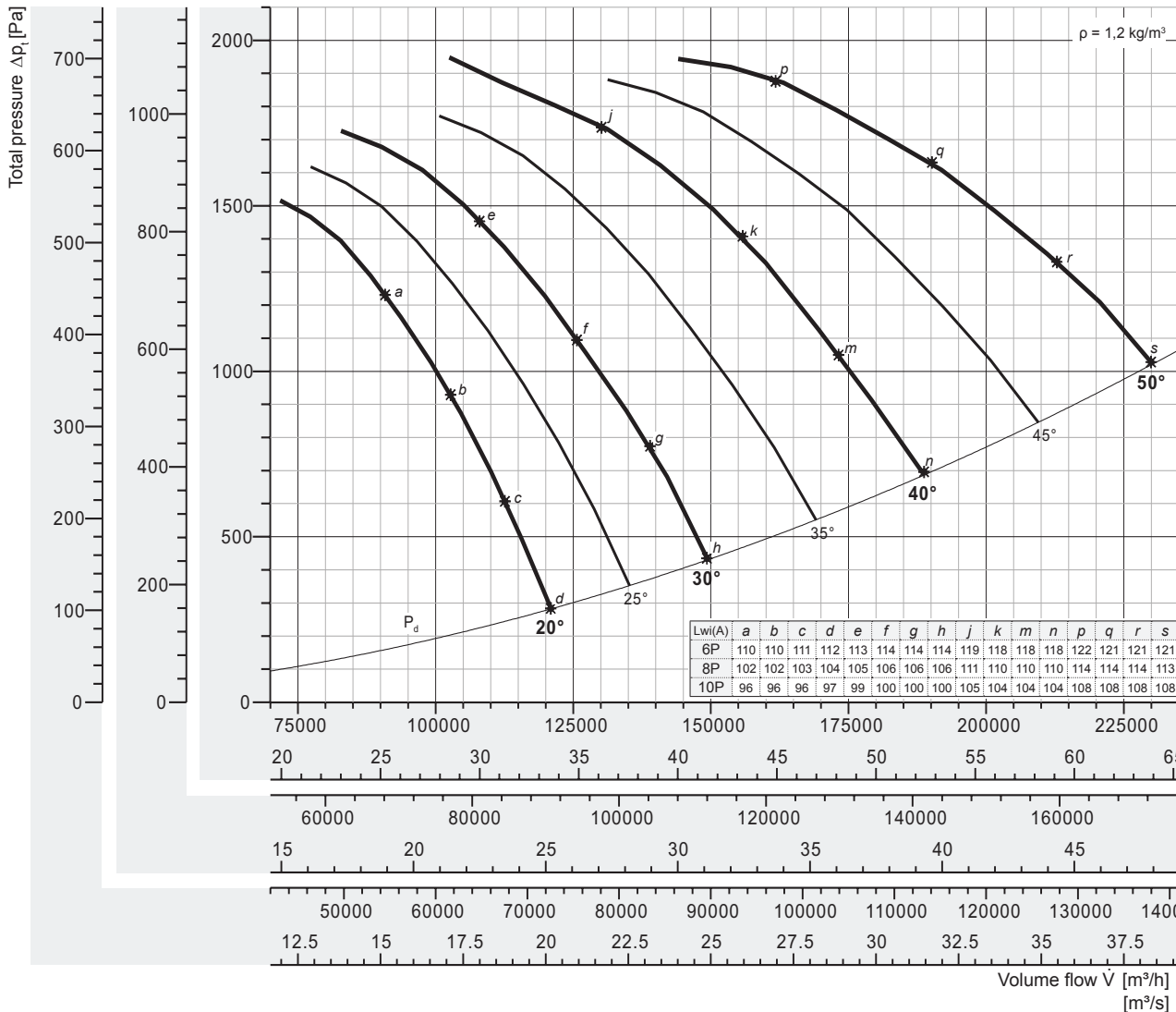
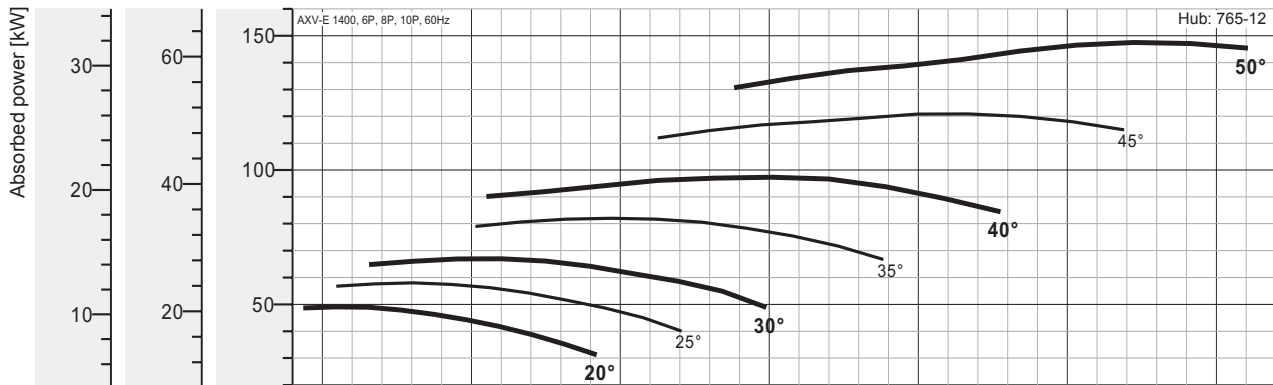

Peak absorbed power [kW]

6-pole = 1200 rpm; 8-pole = 900 rpm; 10-pole = 720 rpm;

N Poles	Pitch angle [°]						
	20	25	30	35	40	45	50
6P motor	49,07	57,97	67,02	82,03	97,37	120,9	147,5
8P motor	20,70	24,45	28,28	34,61	41,08	51,02	62,22
10P motor	10,60	12,52	14,48	17,72	21,03	26,12	31,86

Fan test laboratory AMCA 210/99 Fig.12, Test Chamber. Performance certified is for installation type D - Ducted inlet, Ducted outlet. Performance ratings do not include the effects of appurtenances (accessories-belt cover, pulley & belt). Power rating (kW) does not include transmission losses.

The A-weighted sound ratings shown have been calculated per AMCA International Standard 301. Values shown are for inlet Lw(A) sound power levels for installation Type D: ducted inlet, ducted outlet. Ratings include the effects of duct end correction.

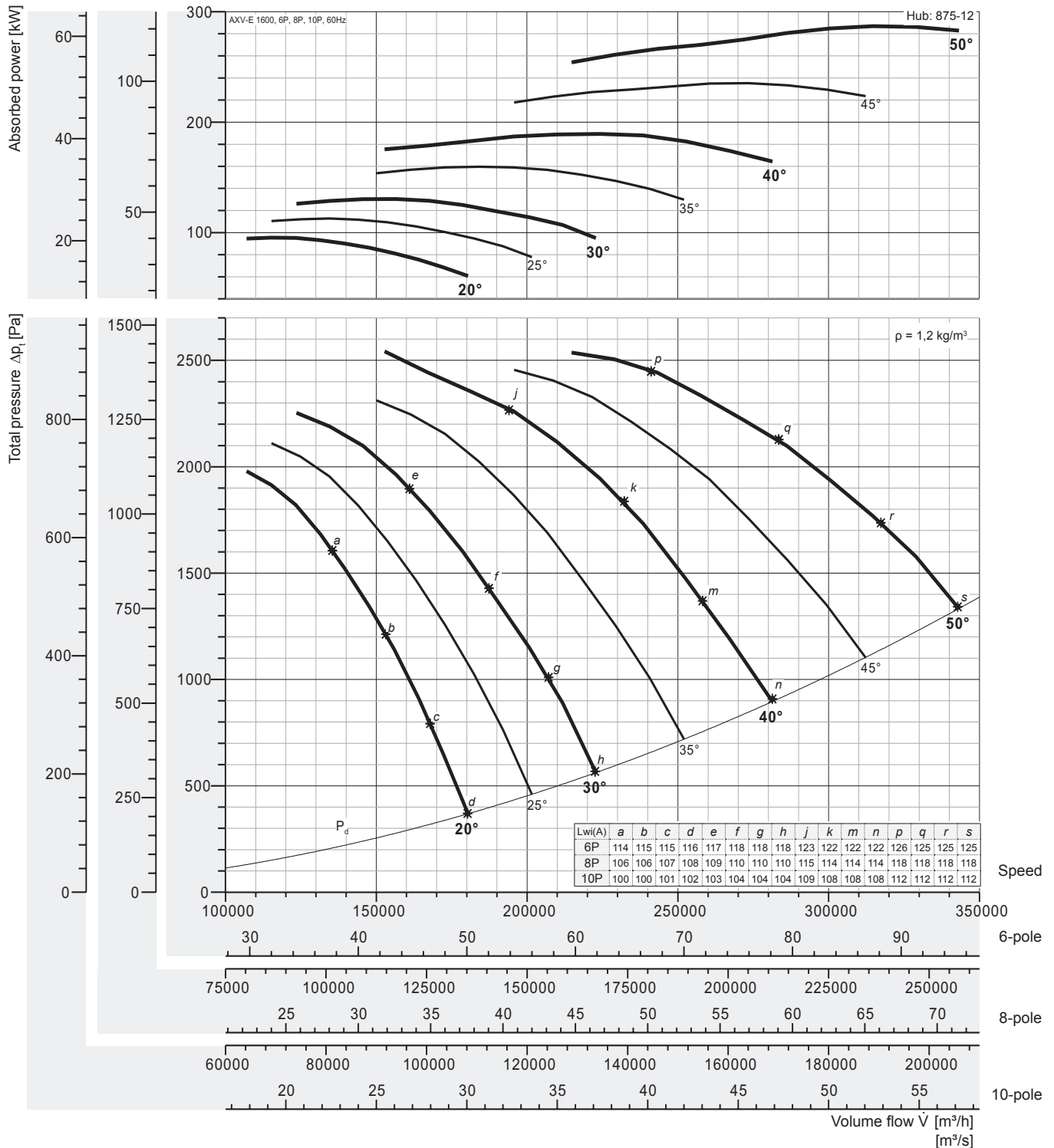

Peak absorbed power [kW]

6-pole = 1200 rpm; 8-pole = 900 rpm; 10-pole = 720 rpm;

N Poles	Pitch angle [°]						
	20	25	30	35	40	45	50
6P motor	95,46	112,8	130,4	159,6	189,4	235,2	286,9
	110	132		160	200	250	315
8P motor	40,27	47,57	55,00	67,32	79,91	99,24	121,0
	45	55		75	90	110	132
10P motor	20,62	24,36	28,16	34,47	40,91	50,81	61,97
	22	30		37	45	55	75

Fan test laboratory AMCA 210/99 Fig.12, Test Chamber. Performance certified is for installation type D - Ducted inlet, Ducted outlet. Performance ratings do not include the effects of appurtenances (accessories-belt cover, pulley & belt). Power rating (kW) does not include transmission losses.

The A-weighted sound ratings shown have been calculated per AMCA International Standard 301. Values shown are for inlet LwiA sound power levels for installation Type D: ducted inlet, ducted outlet. Ratings include the effects of duct end correction.



Performance Curve

AXV-E 1800, 60 Hz

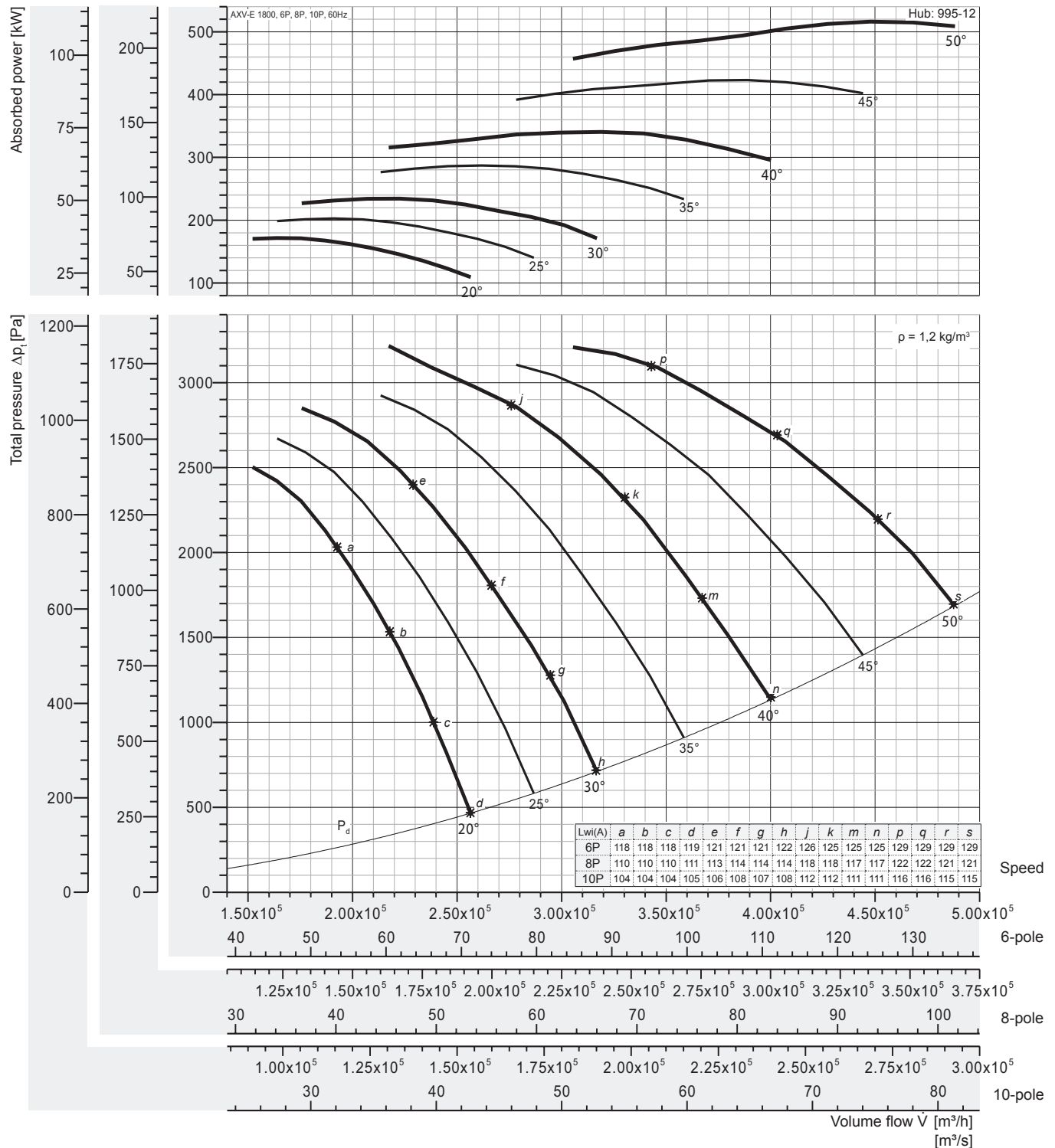

Peak absorbed power [kW]

6-pole = 1200 rpm; 8-pole = 900 rpm; 10-pole = 720 rpm;

N Poles	Pitch angle [°]						
	20	25	30	35	40	45	50
6P motor	171,7 200	202,8 250	234,5	287,0 315	340,7 355	423,2 450	516,1 560
8P motor	72,44 75	85,58 90	98,95 110	121,1 132	143,7 160	178,5 200	217,7 250
10P motor	37,00 37	43,82 45	50,66 55	62,00 75	73,60	91,40 110	111,5 132

Fan test laboratory AMCA 210/99 Fig.12, Test Chamber. Performance certified is for installation type D - Ducted inlet, Ducted outlet. Performance ratings do not include the effects of appurtenances (accessories-belt cover, pulley & belt). Power rating (kW) does not include transmission losses.

The A-weighted sound ratings shown have been calculated per AMCA International Standard 301. Values shown are for inlet Lw(A) sound power levels for installation Type D: ducted inlet, ducted outlet. Ratings include the effects of duct end correction.

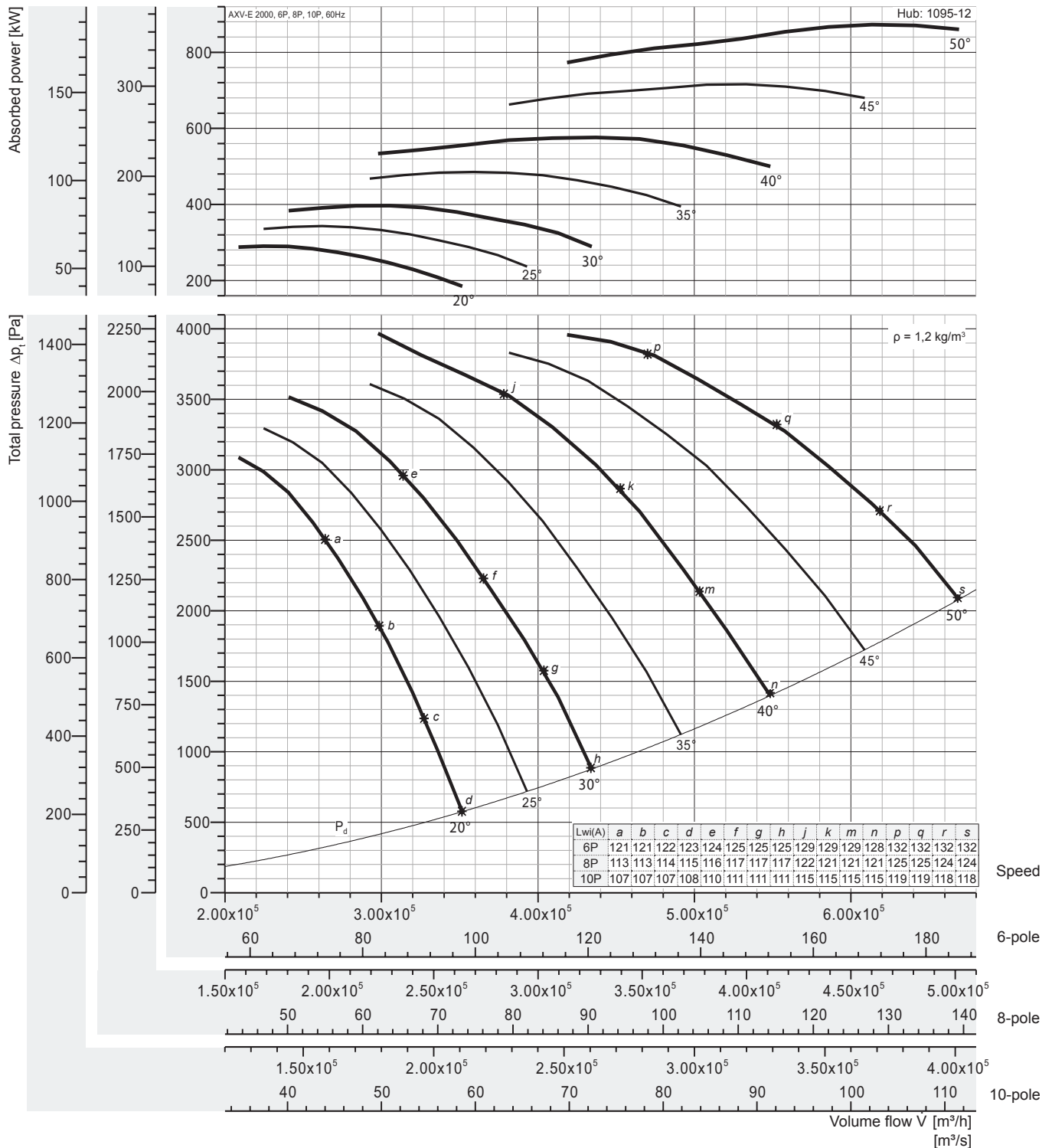

Peak absorbed power [kW]

6-pole = 1200 rpm; 8-pole = 900 rpm; 10-pole = 720 rpm;

N Poles	Pitch angle [°]						
	20	25	30	35	40	45	50
6P motor	290,4	343,0	396,6	485,4	576,2	715,6	872,8
	315	355	400	500	630	-	-
8P motor	122,5	144,7	167,3	204,8	243,1	301,9	368,2
	132	160	200	250		315	400
10P motor	62,73	74,10	85,68	104,8	124,5	154,6	188,5
	75		90	110	132	160	200

Fan test laboratory AMCA 210/99 Fig.12, Test Chamber. Performance certified is for installation type D - Ducted inlet, Ducted outlet. Performance ratings do not include the effects of appurtenances (accessories-belt cover, pulley & belt). Power rating (kW) does not include transmission losses.

The A-weighted sound ratings shown have been calculated per AMCA International Standard 301. Values shown are for inlet LwiA sound power levels for installation Type D: ducted inlet, ducted outlet. Ratings include the effects of duct end correction.



Performance Curve

AXV-E 2200, 60 Hz

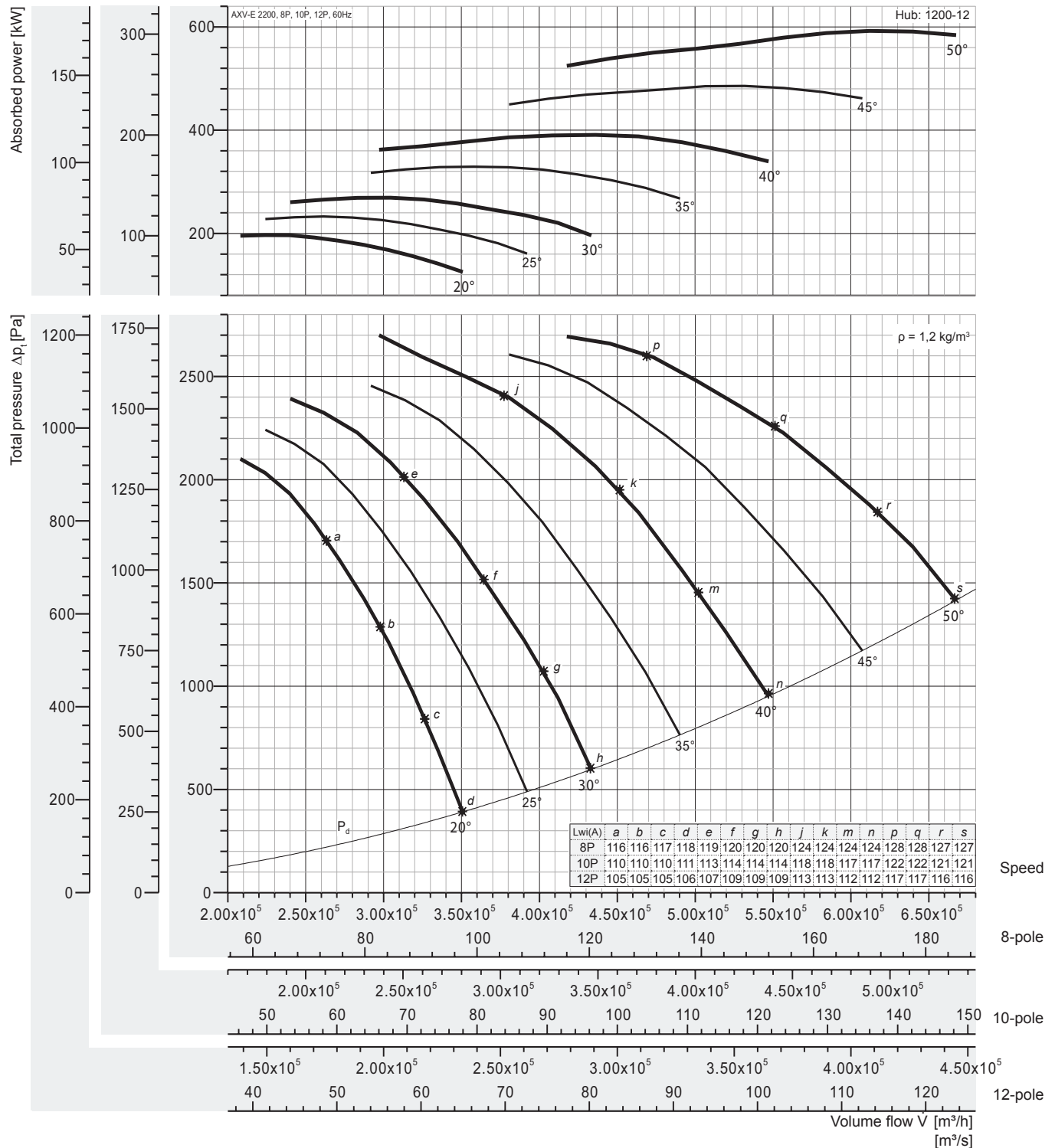

Peak absorbed power [kW]

8-pole = 900 rpm; 10-pole = 720 rpm; 12-pole = 600 rpm;

N Poles	Pitch angle [°]						
	20	25	30	35	40	45	50
8P motor	197,1	232,8	269,2	329,4	391,1	485,7	592,3
10P motor	100,9	119,2	137,8	168,7	200,0	248,7	303,3
12P motor	58,40	68,98	79,76	97,61	115,9	143,9	175,5

Fan test laboratory AMCA 210/99 Fig.12, Test Chamber. Performance certified is for installation type D - Ducted inlet, Ducted outlet. Performance ratings do not include the effects of appurtenances (accessories-belt cover, pulley & belt). Power rating (kW) does not include transmission losses.

The A-weighted sound ratings shown have been calculated per AMCA International Standard 301. Values shown are for inlet L_{wi}A sound power levels for installation Type D: ducted inlet, ducted outlet. Ratings include the effects of duct end correction.

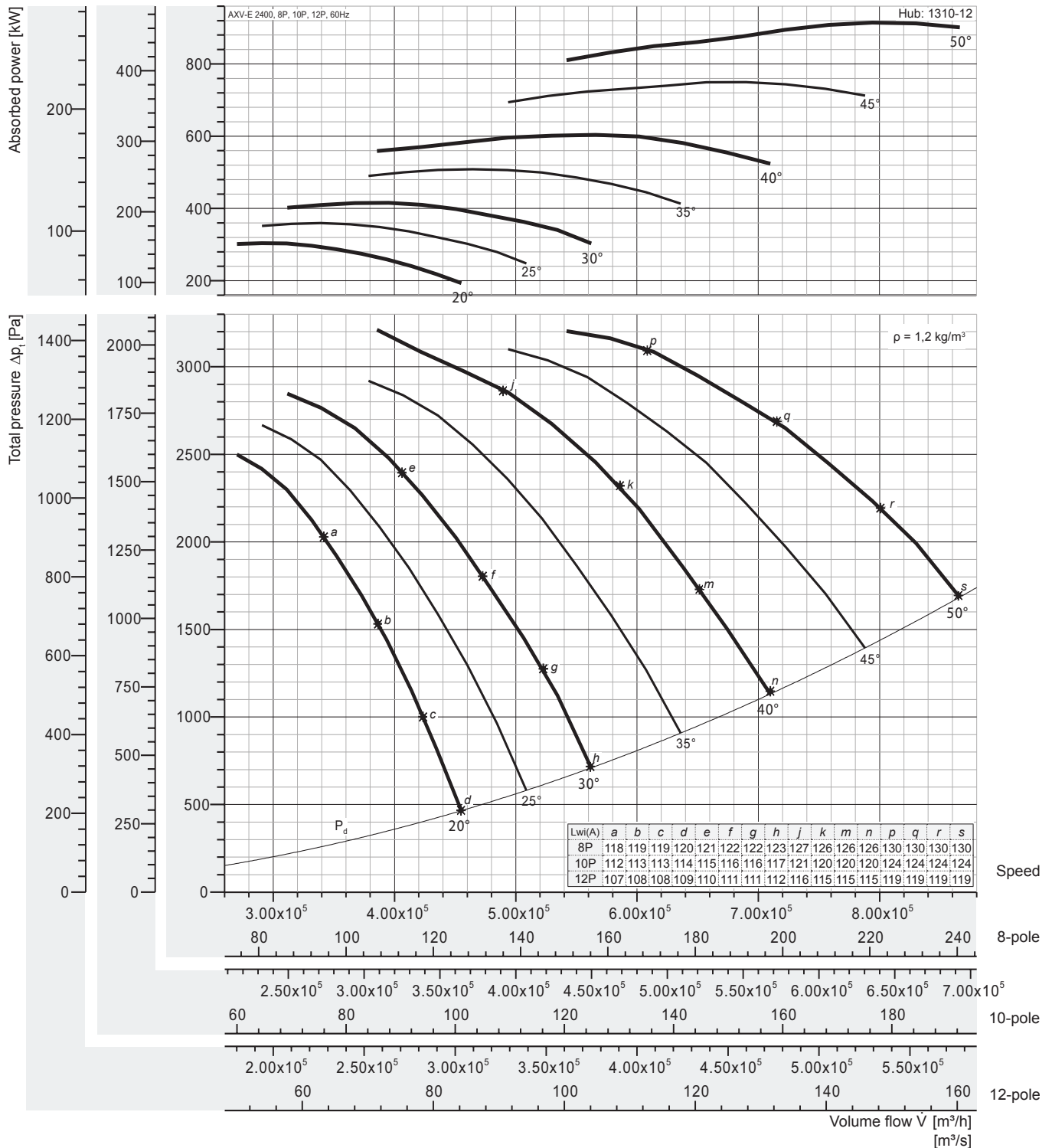

Peak absorbed power [kW]

8-pole = 900 rpm; 10-pole = 720 rpm; 12-pole = 600 rpm;

N Poles	Pitch angle [°]						
	20	25	30	35	40	45	50
8P motor	304,2	359,4	415,5	508,5	603,6	749,7	914,3
	315	400	450	560	630	-	-
10P motor	155,8	184,0	212,7	260,4	309,1	383,8	468,1
	160	200	250	315	400	500	
12P motor	90,14	106,5	123,1	150,7	178,9	222,1	270,9
	110		132	160	200	250	315

Fan test laboratory AMCA 210/99 Fig.12, Test Chamber. Performance certified is for installation type D - Ducted inlet, Ducted outlet. Performance ratings do not include the effects of appurtenances (accessories-belt cover, pulley & belt). Power rating (kW) does not include transmission losses.

The A-weighted sound ratings shown have been calculated per AMCA International Standard 301. Values shown are for inlet Lw(A) sound power levels for installation Type D: ducted inlet, ducted outlet. Ratings include the effects of duct end correction.



Performance Curve

AXV-E 2500, 60 Hz

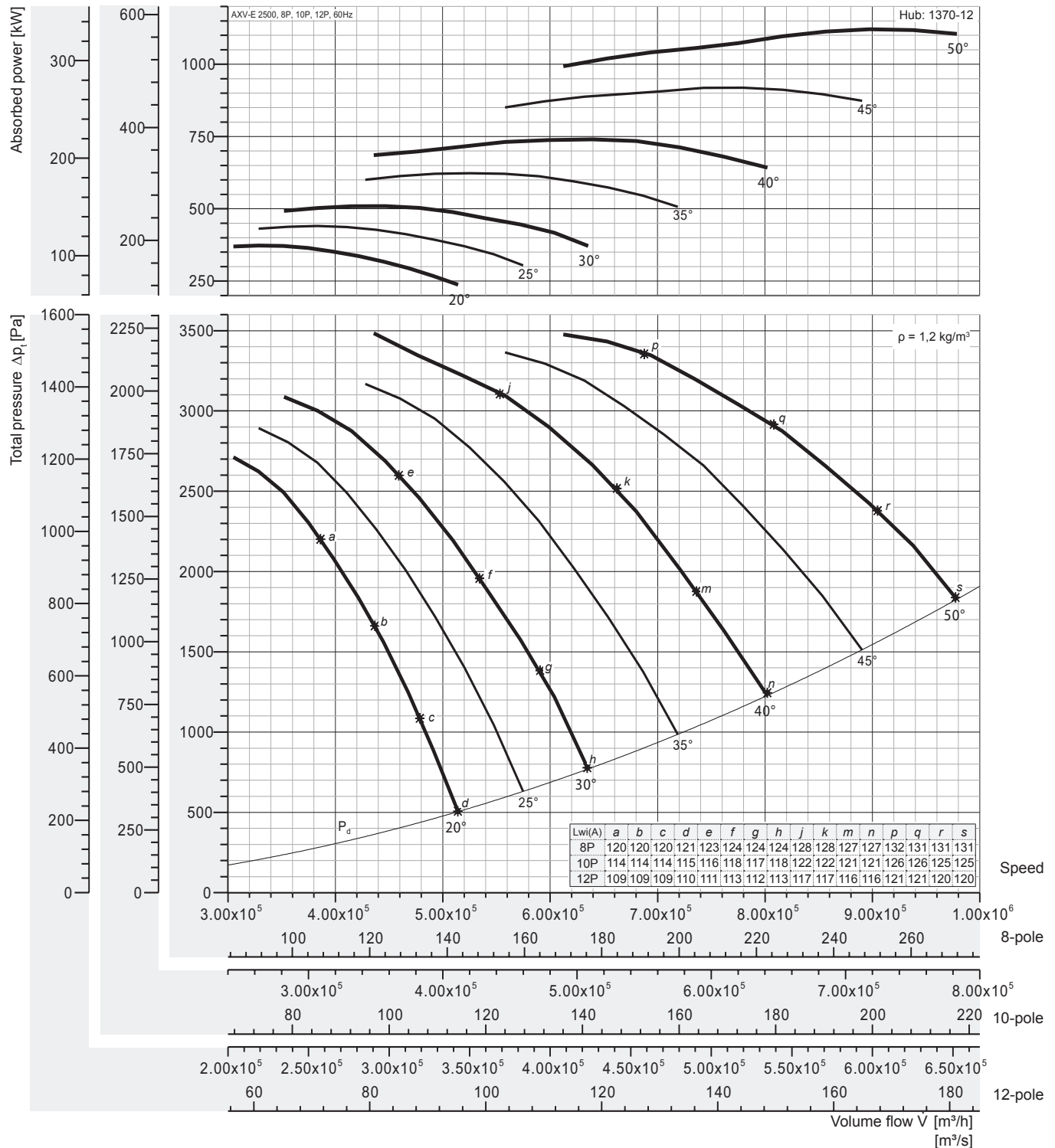

Peak absorbed power [kW]

8-pole = 900 rpm; 10-pole = 720 rpm; 12-pole = 600 rpm;

N Poles	Pitch angle [°]						
	20	25	30	35	40	45	50
8P motor	372,9	440,6	509,4	623,4	740,0	919,1	1120,9
	400	450	560	630	-	-	-
10P motor	190,9	225,6	260,8	319,2	378,9	470,6	573,9
	200	250	315	355	400	500	630
12P motor	110,0	130,5	150,9	184,7	219,3	272,3	332,1
	110	132	160	200	250	315	355

Fan test laboratory AMCA 210/99 Fig.12, Test Chamber. Performance certified is for installation type D - Ducted inlet, Ducted outlet. Performance ratings do not include the effects of appurtenances (accessories-belt cover, pulley & belt). Power rating (kW) does not include transmission losses.

The A-weighted sound ratings shown have been calculated per AMCA International Standard 301. Values shown are for inlet LwiA sound power levels for installation Type D: ducted inlet, ducted outlet. Ratings include the effects of duct end correction.

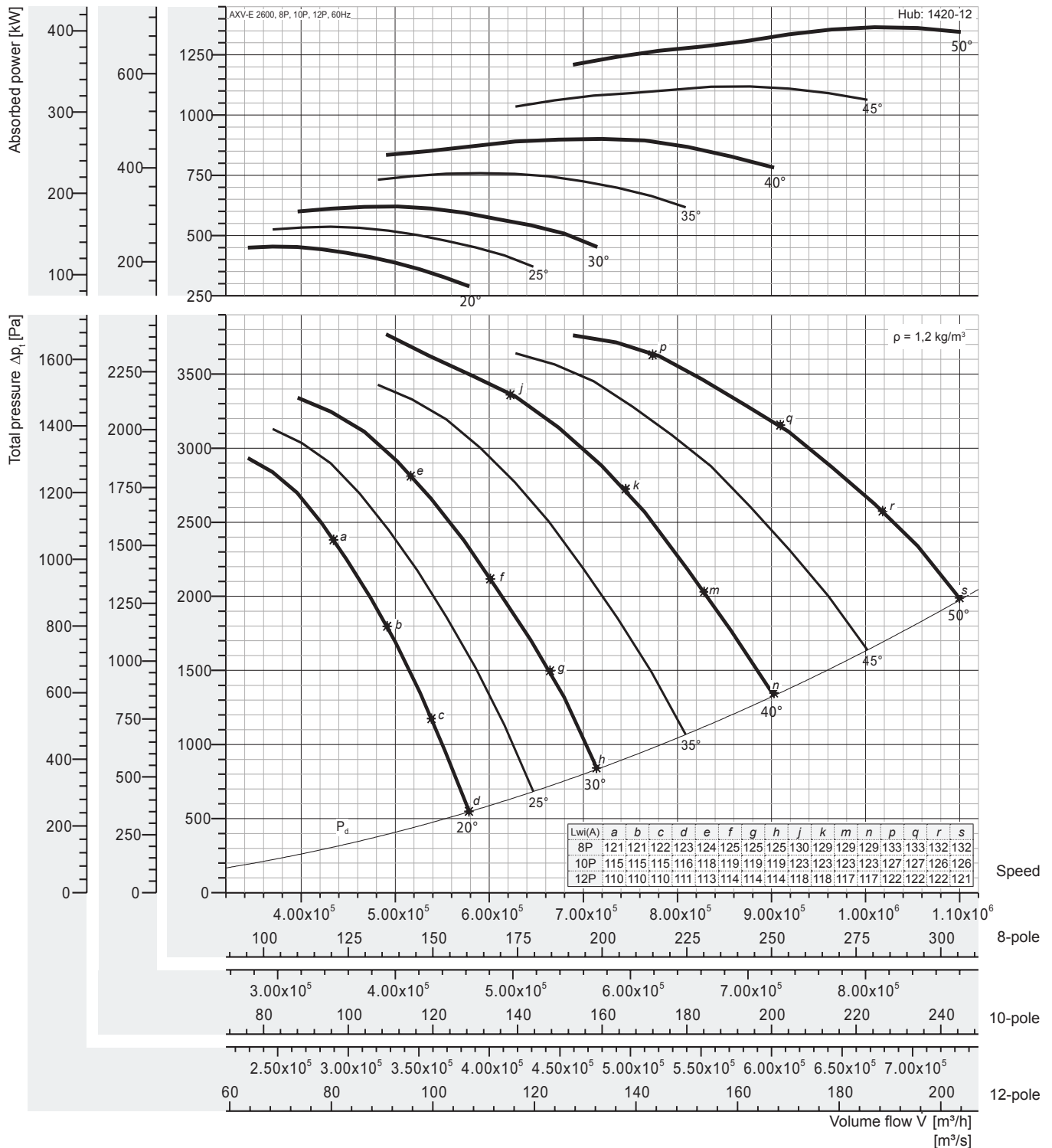

Peak absorbed power [kW]

8-pole = 900 rpm; 10-pole = 720 rpm; 12-pole = 600 rpm;

N Poles	Pitch angle [°]						
	20	25	30	35	40	45	50
8P motor	454,0	536,3	620,1	758,9	900,8	1119	1365
	500	560	630	-	-	-	-
10P motor	232,5	274,6	317,5	388,6	461,2	572,8	698,6
	250	315	355	400	500	630	710
12P motor	134,5	158,9	183,7	224,9	266,9	331,5	404,3
	160		200	250	315	355	450

Fan test laboratory AMCA 210/99 Fig.12, Test Chamber. Performance certified is for installation type D - Ducted inlet, Ducted outlet. Performance ratings do not include the effects of appurtenances (accessories-belt cover, pulley & belt). Power rating (kW) does not include transmission losses.

The A-weighted sound ratings shown have been calculated per AMCA International Standard 301. Values shown are for inlet Lw(A) sound power levels for installation Type D: ducted inlet, ducted outlet. Ratings include the effects of duct end correction.



Performance Curve

AXV-E 2800, 60 Hz

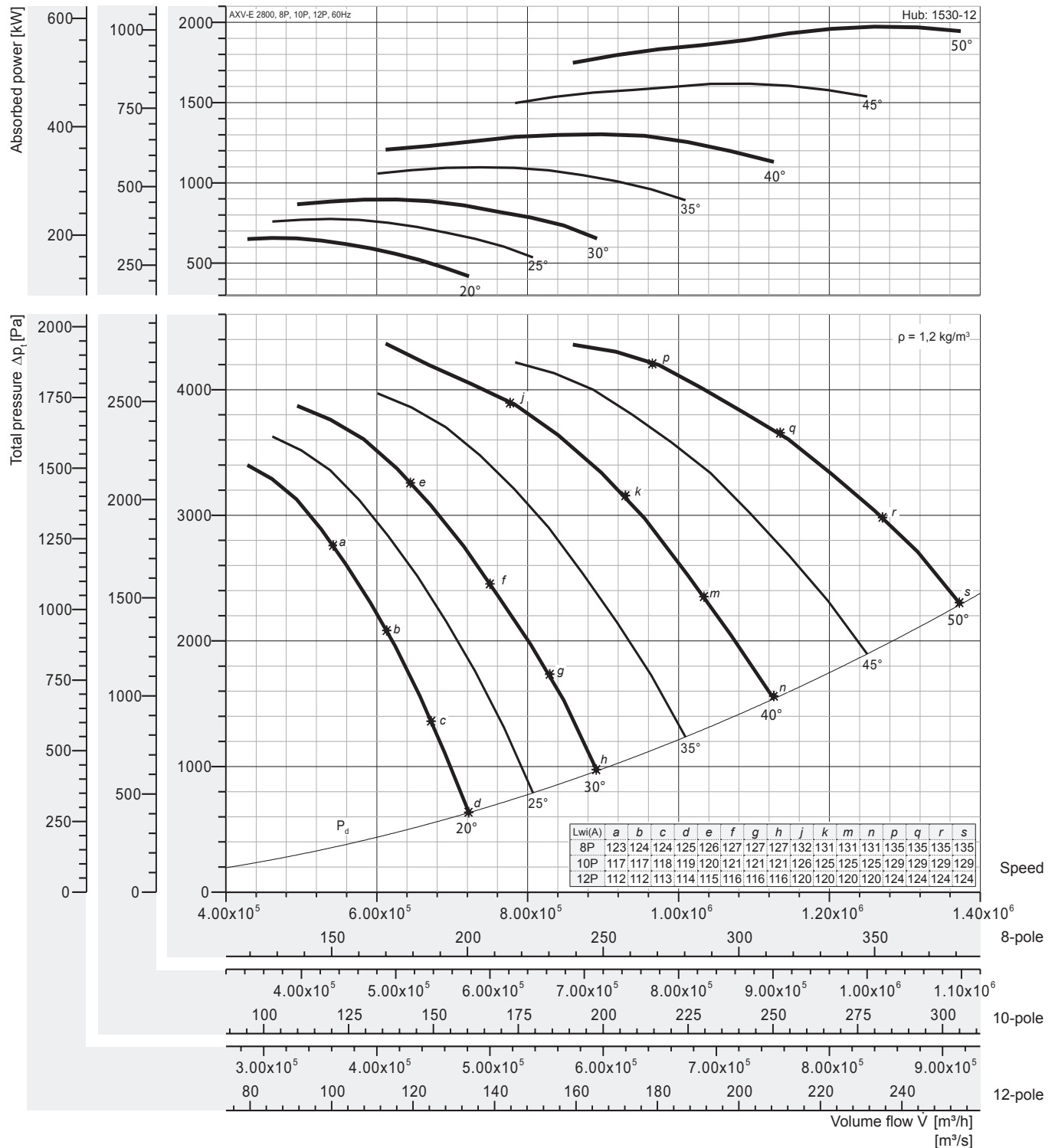

Peak absorbed power [kW]

8-pole = 900 rpm; 10-pole = 720 rpm; 12-pole = 600 rpm;

N Poles	Pitch angle [°]						
	20	25	30	35	40	45	50
8P motor	656,6 710	775,6 -	896,8 -	1097 -	1302 -	1618 -	1973 -
10P motor	336,2 355	397,1 400	459,1 500	561,9 630	667, 710	828,4 -	1010 -
12P motor	194,5 200	229,8 250	265,7 315	325,2 355	386,0 400	479,4 500	584,7 630

Fan test laboratory AMCA 210/99 Fig.12, Test Chamber. Performance certified is for installation type D - Ducted inlet, Ducted outlet. Performance ratings do not include the effects of appurtenances (accessories-belt cover, pulley & belt). Power rating (kW) does not include transmission losses.

The A-weighted sound ratings shown have been calculated per AMCA International Standard 301. Values shown are for inlet Lw(A) sound power levels for installation Type D: ducted inlet, ducted outlet. Ratings include the effects of duct end correction.

Vane Axial Flow Fans

Dimensions



Direct Driven

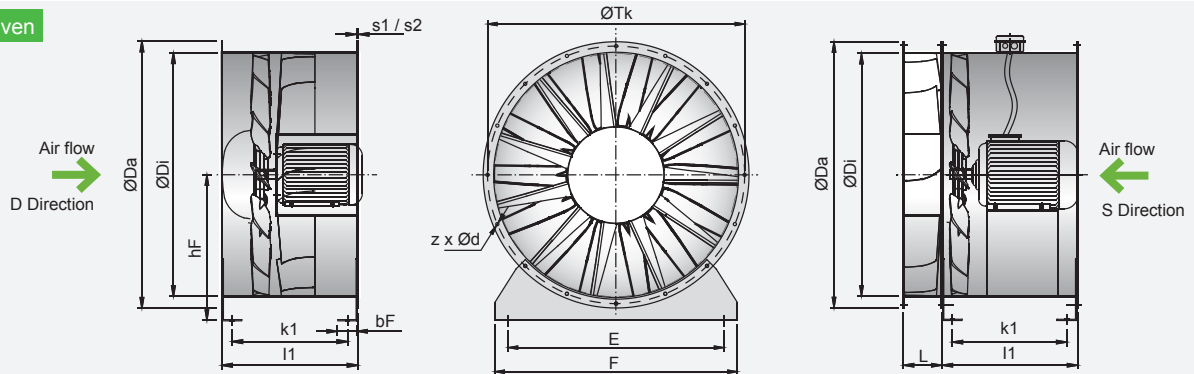

Belt Driven

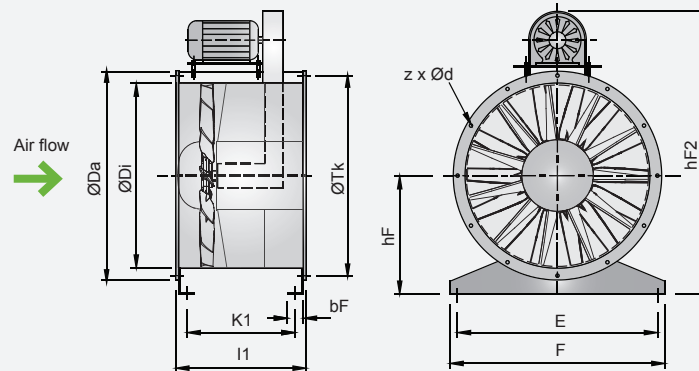

Model size	Da [mm]	Di [mm]	hF [mm]	hF2 [mm]	z x d [mm]	Tk [mm]	E [mm]	F [mm]	L [mm]	bF [mm]
800	904	797	500	1544	12* x 14	861	730	800	190	80
900	1004	894	580	1746	12* x 14	958	830	900	200	80
1000	1105	1003	630	1821	12* x 14	1067	930	990	200	80
1120	1245	1125	690	1990	16* x 18	1200	1050	1110	240	100
1250	1370	1250	750	2175	16* x 18	1337	1180	1240	240	100
1400	1525	1405	830	2362	16* x 18	1475	1330	1390	260	100
1600	1725	1605	930	2550	20* x 18	1675	1530	1590	260	100

Model size	LH/1							
	s1 [mm]	k1 [mm]	l1 [mm]	motor max.	s2 [mm]	k1 [mm]	l1 [mm]	motor max.
800	2,5	316	401	180	2	316	401	160
900	3	429	515	200	2	429	515	180
1000	3	429	515	225	2	429	515	200
1120	4	522	630	225	2	522	630	200
1250	4	522	630	250	3	522	630	225

Model size	LH/2							
	s1 [mm]	k1 [mm]	l1 [mm]	motor max.	s2 [mm]	k1 [mm]	l1 [mm]	motor max.
800	3	614	700	200	2	614	700	180
900	4	612	700	225	2	612	700	200
1000	4	692	780	250	2	692	780	225
1120	4	892	1000	250	2	892	1000	225
1250	4	892	1000	280	3	892	1000	250
1400	4	892	1000	315	3	892	1000	280
1600	4	892	1000	315	3	892	1000	280

We reserve the right to alter measurements without notice in case of technical improvements.

Vane Axial Flow Fans

Dimensions

AXV-E

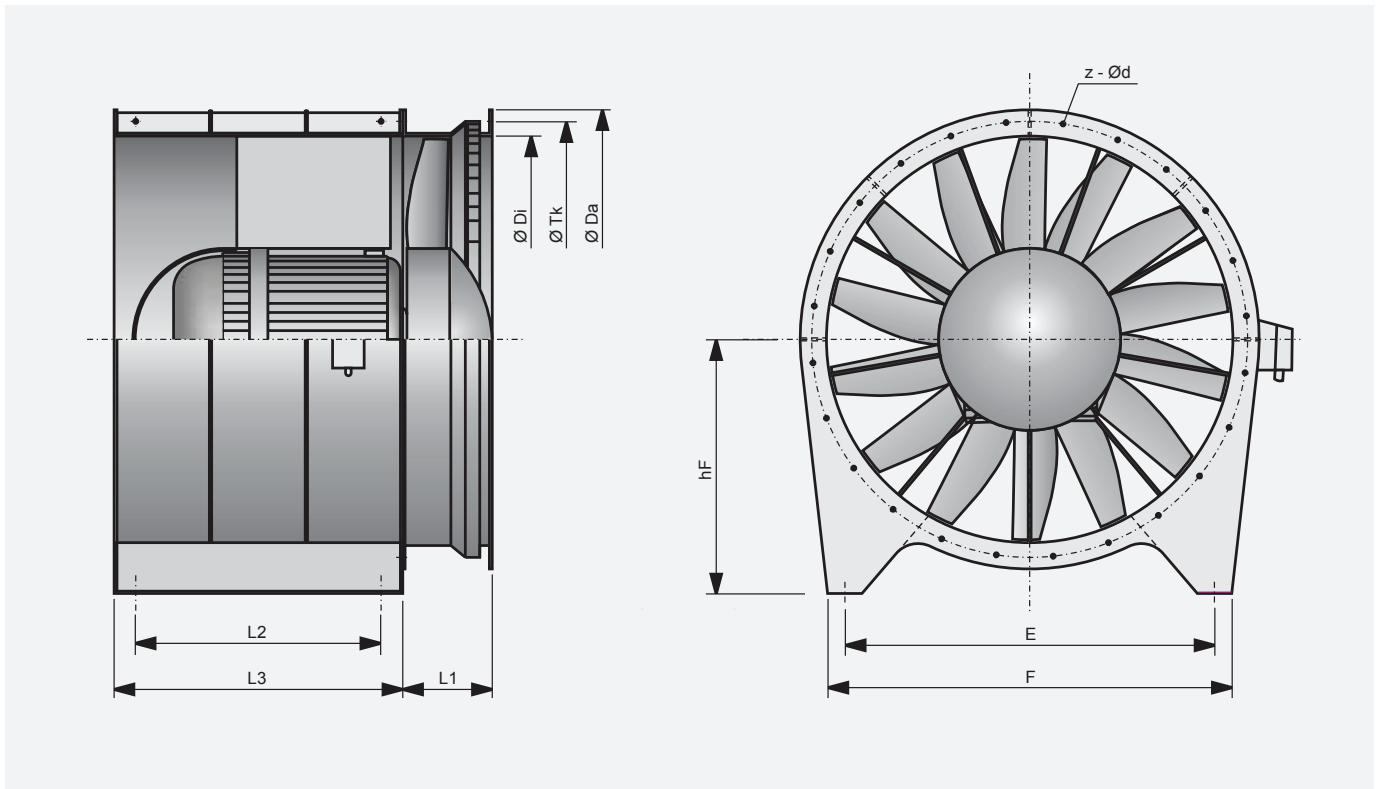

Baugröße size	Da [mm]	Di [mm]	hF [mm]	z x d [mm]	Tk [mm]	E [mm]	F [mm]	L1 [mm]	L2 [mm]	L3 [mm]
1800	2010	1805	1120	24x18	1920	1660	1800	400	1200	1400
2000	2210	2005	1165	32x18	2120	1820	2000	445	1300	1500
2200	2440	2205	1265	32x18	2340	2020	2200	490	1400	1650
2400	2630	2405	1370	32x18	2530	2220	2400	550	1500	1800
2500	2740	2505	1420	36x24	2640	2320	2500	555	1530	1820
2600	2840	2605	1470	36x24	2740	2380	2600	590	1580	1850
2800	3150	2805	1570	36x24	3000	2500	2800	1300	1680	1900

ED

Bellmouth inlet

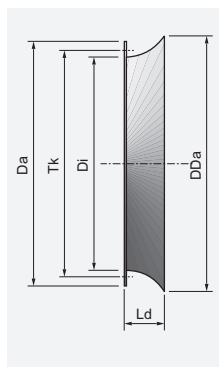

GL-AXV

Matching flange

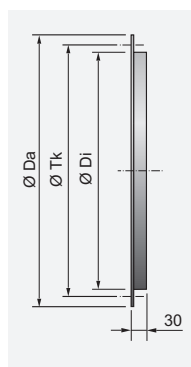

EV-AXV

Flexible connector compl.

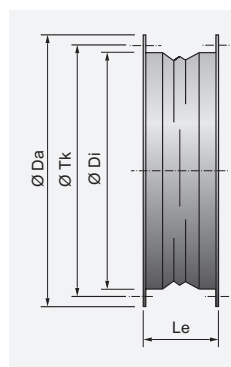

LRK

Air-operated damper

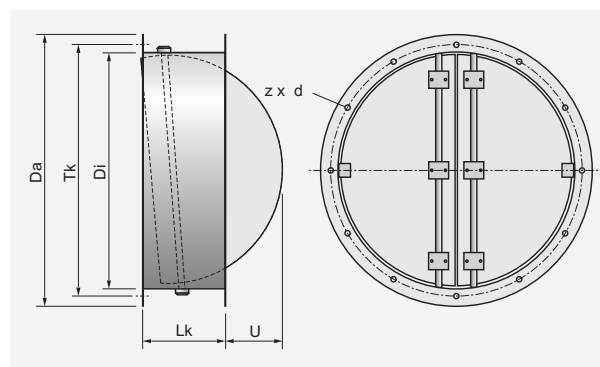

Model size	Da [mm]	Di [mm]	Tk [mm]	z x d [mm]	DDa [mm]	Ld [mm]	Lk [mm]	Le [mm]	U [mm]
800	904	797	861	12* x 14	915	250	350	130	110
900	1004	894	958	12* x 14	1015	250	350	130	170
1000	1105	1003	1067	12* x 14	1115	250	350	130	225
1120	1245	1125	1200	16* x 18	1243	250	350	130	255
1250	1370	1250	1337	16* x 18	1364	250	400	170	375
1400	1525	1405	1475	16* x 18	1523	250	400	170	450
1600	1725	1605	1675	20* x 18	1723	250	400	170	550

Vane Axial Flow Fans

Sound Information

Sound power levels

This term refers to the power which a source radiates as sound. Sound power levels are expressed in decibels with a reference level of 1 pWatt. The sound power level of a source remains the same regardless of its environment and the distance to the listener.

If the sound power frequency spectrum is needed, for as follows: example, the design of sound attenuators, the A-weighted rated sound power levels at particular octave band frequency L_{WA} can be calculated by subtracting the relative sound L_{wrel} .

$$L_{WA} = L_{wi} + L_{wrel}$$

Sound pressure level

These are pressure fluctuations generated by a source expressed in decibels with a reference level of 20 μ Pa. The sound pressure level varies with the distance of a sound source to the listener and its environment.

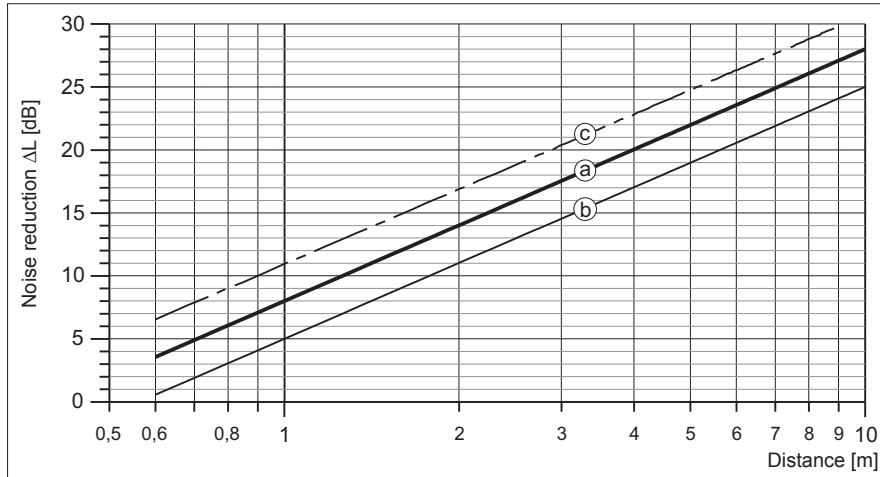

Sound level reduction half sphere

- a: without reflexion
- b: with reflexion
- c: full sphere without reflexion

Frequencies

Sound is split into different frequencies. Frequencies of human hearing range from about 20 cycles per second (Hz) to 20,000 cycles per second (Hz). For practical purposes, WOLTER publishes noise data in eight octave bands with the centre frequencies of (63,) 125, 250, 500, 1000, 2000, 4000 and 8000 Hz. Each fan has its own specific correction factor which is to be deducted from sound power according to the octave band.

A-weighted sound pressure level in dB (A)

The human ear is more sensitive to sound in some frequencies than in others. The A-weighting is an attempt to reflect this natural perception of sound. The A-weighting is a set of figures which are applied to the sound pressure levels. The levels in each of the octave bands are added logarithmically to give a single figure. The A-weighting over the octave band is as follows:

Table 1)

Frequency [Hz]	63	125	250	500	1000	2000	4000	8000
A-weighting [dB]	-25,5	-15,5	-8,5	-3	0	+1	+1	-1

Table 2)
Addition of sound levels

Difference between two sound levels [dB]	Add to the higher level [dB]
0 - 1	3
2 - 3	2
4 - 9	1
≥ 10	0

$$L_{\Sigma} = 10 \cdot \lg(10^{0,1 \cdot L_1} + 10^{0,1 \cdot L_2} + \dots + 10^{0,1 \cdot L_n})$$

where:

L_1 = sound level of a source 1

L_{Σ} = resulting summation sound level

Summation of several congeneric sound levels

$$L_{\Sigma} = L_1 + 10 \cdot \lg(z)$$

where:

z = number of sources

L_1 = sound level of a single source

L_{Σ} = resulting summation sound level

Relative Sound Power Frequency Spectrum (L_{wrel}) [dB]

Fan Model	Poles	63	125	250	500	1000	2000	4000	8000
Size	[-]	[Hz]	[Hz]	[Hz]	[Hz]	[Hz]	[Hz]	[Hz]	[Hz]
800	4	-8	-3	-8	-10	-13	-16	-22	-28
	6	-5	-7	-8	-10	-13	-18	-24	-28
	8	-4	-7	-7	-10	-13	-19	-24	-27
900	4	-10	-4	-6	-10	-14	-16	-22	-28
	6	-6	-4	-7	-11	-14	-17	-24	-27
	8	-5	-5	-7	-11	-13	-19	-25	-26
1000	4	-11	-4	-6	-10	-13	-16	-22	-28
	6	-7	-4	-7	-10	-13	-17	-24	-29
	8	-5	-5	-8	-10	-13	-19	-25	-30
1120	4	-10	-4	-6	-10	-13	-16	-22	-28
	6	-7	-4	-7	-10	-13	-18	-24	-29
	8	-5	-5	-8	-11	-14	-19	-26	-30
1250	4	-10	-4	-6	-10	-13	-16	-22	-28
	6	-7	-4	-7	-11	-14	-18	-25	-30
	8	-5	-5	-8	-11	-14	-20	-26	-30
1400	6	-6	-4	-7	-11	-14	-18	-25	-30
	8	-4	-5	-8	-11	-14	-20	-26	-31
	10	-4	-5	-8	-11	-15	-21	-27	-31
1600	6	-6	-4	-8	-11	-14	-19	-25	-30
	8	-4	-5	-9	-12	-15	-20	-27	-31
	10	-4	-5	-9	-11	-15	-21	-27	-31
1800	6	-6	-4	-8	-11	-14	-19	-25	-31
	8	-4	-5	-9	-12	-15	-21	-27	-31
	10	-4	-5	-9	-12	-16	-22	-28	-31
2000	6	-5	-4	-8	-12	-15	-19	-26	-31
	8	-4	-5	-9	-12	-15	-21	-27	-32
	10	-3	-6	-9	-12	-16	-22	-28	-32
2200	8	-3	-5	-9	-12	-16	-21	-28	-32
	10	-3	-6	-9	-12	-16	-22	-28	-32
	12	-3	-6	-9	-12	-17	-23	-28	-32
2400	8	-3	-5	-10	-13	-16	-21	-28	-32
	10	-3	-6	-10	-12	-16	-22	-28	-32
	12	-3	-6	-9	-12	-17	-23	-28	-32
2500	8	-3	-6	-10	-13	-16	-21	-28	-32
	10	-3	-6	-10	-12	-16	-23	-28	-32
	12	-3	-6	-9	-12	-17	-23	-28	-32
2600	8	-3	-6	-10	-13	-16	-22	-28	-32
	10	-3	-6	-10	-12	-16	-23	-28	-32
	12	-3	-6	-10	-12	-17	-23	-29	-32
2800	8	-4	-5	-9	-12	-15	-20	-27	-32
	10	-3	-6	-10	-13	-16	-22	-28	-32
	12	-3	-6	-10	-13	-17	-23	-29	-32

* Sound power frequency spectrum calculated with this L_{wrel} are not licensed by AMCA International.

Tubular Sound Attenuator for AXV-E

SA, SPA

SPA 800 -1D

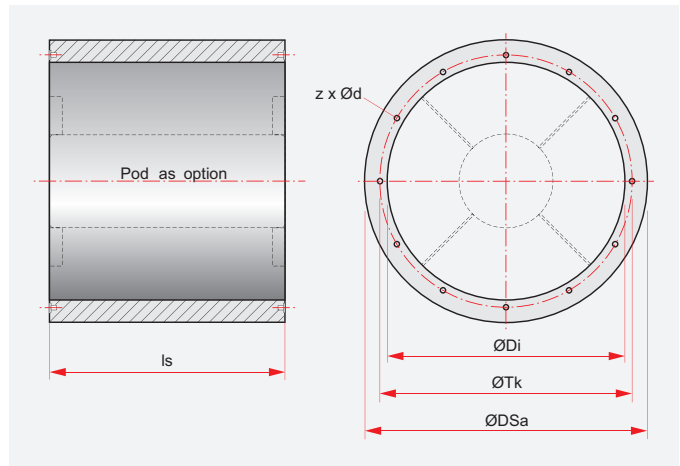
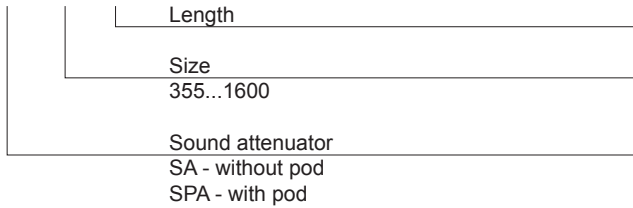

Attenuators made of galvanised sheet steel. Connecting flanges correspond to those of the AXV axial fan series.

Size	DSa	Tk	Di	ls		■				Length	Type	Pitch angle	Octave band mid-frequency [Hz]												
				x 1D	x 2D	SA-1D	SPA-1D	SA-2D	SPA-2D				63	125	250	500	1k	2k	4k	8k					
	[mm]	[mm]	[mm]	[mm]	[mm]	[kg]	[kg]	[kg]	[kg]			setting													
355 400 450	459	405	359	355	710	12	18	16	23	1D	SA-1D	all	2	4	6	10	14	10	7	8					
	601	448	401	400	800	14	23	19	29			low	4	6	8	13	20	21	18	16					
	650	497	450	450	900	18	29	23	36			med	4	6	8	12	18	19	18	14					
												high	4	6	8	11	13	16	16	11					
500 560 630 710 800	704	551	504	500	1000	22	36	28	43	1D	SA-1D	all	3	4	8	14	14	9	8	7					
												SPA-1D	low	4	6	9	17	26	21	18	12				
													med	4	6	9	17	23	20	18	11				
													high	4	6	9	16	17	16	14	11				
2D	SA-2D	low	6	8	14	23	24	15	13	10															
		med	6	8	13	22	22	14	13	9															
		high	6	8	12	20	18	13	11	9															
	SPA-2D	low	8	11	16	30	39	35	32	22															
med		8	11	16	27	32	32	29	19																
high		8	11	16	24	23	23	24	17																
900 1000 1120 1250	1094	958	894	900	1800	86	135	112	176	1D	SA-1D	all	3	4	9	14	12	8	7	7					
												SPA-1D	low	4	6	11	22	21	16	14	11				
													med.	4	6	11	20	19	15	13	11				
													high	4	6	11	17	17	14	12	11				
2D	SA-2D	low	6	8	14	22	20	13	12	10															
		med.	6	8	13	21	18	12	11	10															
		high	6	8	12	19	15	11	10	9															
	SPA-2D	low	8	11	19	30	32	30	24	17															
med.		8	11	19	26	27	26	22	17																
high		8	11	19	21	20	22	20	16																
1400 1600	1605	1475	1405	1400	2800	197	316	250	397	1D	SA-1D	all	4	5	10	14	11	7	6	6					
												SPA-1D	low	5	7	12	21	20	14	12	9				
													med.	5	7	12	19	18	13	11	9				
													high	5	7	12	15	16	12	10	8				
2D	SA-2D	low	8	9	15	20	19	12	11	9															
		med.	8	9	14	20	17	11	10	9															
		high	8	9	13	19	14	10	9	9															
	SPA-2D	low	10	14	22	28	31	29	18	15															
med.		10	14	22	25	27	25	16	15																
high		10	14	22	21	21	21	15	14																

• Low, Medium and High Pitch Angle setting correspond to 10°, 22° and 35° pitch angle approximately; for other pitch angles use interpolation.

• Sizes 1800 - 2800 TBA.

Pressure Loss SPA - 1D

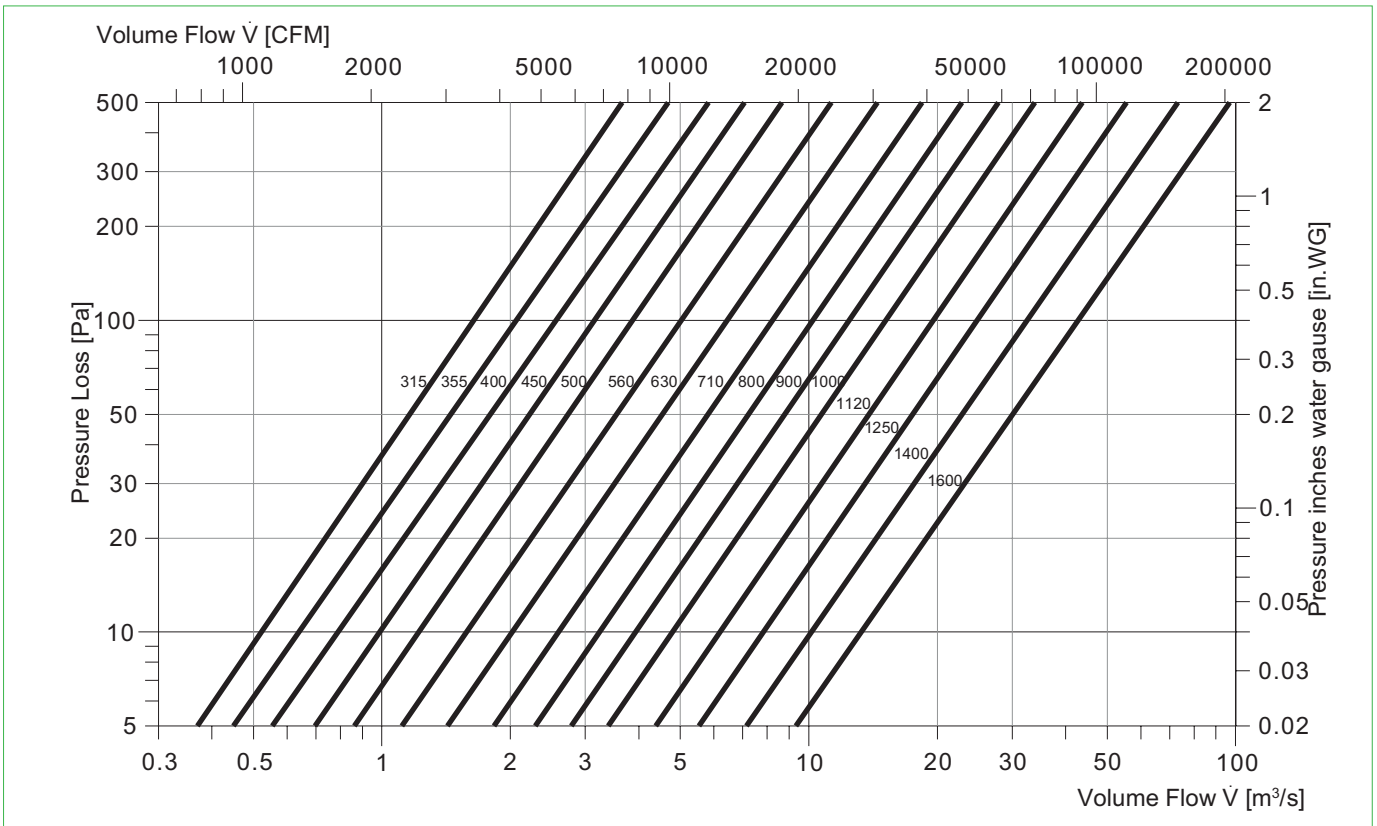

Pressure Loss SPA - 2D

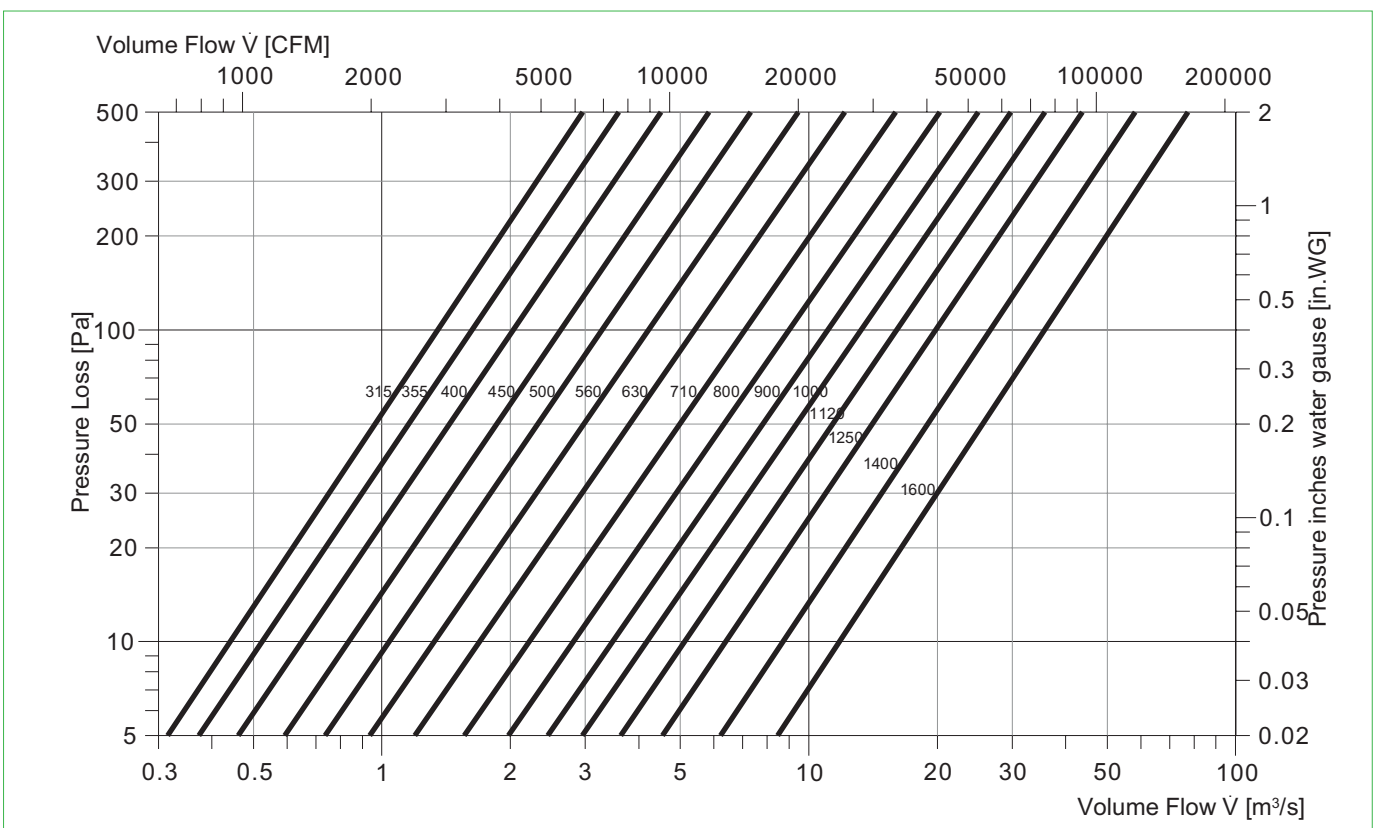

• Performance of sound attenuator are not licensed by AMCA International.

Wolter Sales Network

Inland

Ing. Günther Rößler
D-07619 Schkölen
Tel. (+49) 03 66 94 / 22 359
Fax (+49) 03 66 94 / 22 357
guenther.roessler@wolterfans.de

Mattias Industrievertretungen
D-16259 Bad Freienwalde
Tel. (+49)03344/301994
Fax (+49)03344/301996
thomas.mattias@wolterfans.de

Industrieservice Drexler
D-49080 Osnabrück
Tel. (+49) 0 541 / 20 04 88 3
Fax (+49) 0 541 / 20 04 88 4
wolfgang.drexler@wolterfans.de

Burkhardt Projekt GmbH
D-67583 Guntersblum
Tel. (+49) 0 62 49 / 82 01
Fax (+49) 0 62 49 / 88 58
info@bp-wolter.de

Friedrich Glock
D-97980 Bad Mergentheim
Tel. (+49) 0 79 31 / 37 44
Fax (+49) 0 79 31 / 28 58
friedrich.glock@wolterfans.de

Europe

Danmark:

Air-Con Danmark A/S
DK-8400 Ebeltoft
Tel. (+45)086/345111
Fax (+45)086/345810
jbj@air-con.dk

Hungary:

Air-Technik Légtechnikai Kft.
HU-2040 Budaörs
Tel. (+36)023/428533
Fax (+36)023/428544
bp.air-technik@troges.hu

Ireland:

Finheat Ltd.
IE-Dublin 12, Walkinstown
Tel. (+353)01/4564066
Fax (+353)01/4564071
sales@finheat.com

Lithuania:

JSC Saldos Prekyba
LT-78109 Siauliai
Tel. (+37)041/540212
Fax (+37)041/596176
prekyba@saldai.lt

Netherlands:

AirFan B. V.
NL-7442 CX Nijverdal
Tel. (+31)054/8366366
Fax (+31)054/8365320
ventilatie@airfan.nl

Rucon B. V. Ventilatoren
NL-3840 AG Harderwijk
Tel. (+31)034/1411670
Fax (+31)034/1411690
verkoop@rucon.nl

Österreich:

Wolter Werksvertretung Österreich
A-4040 Linz
Tel. (+43) 07 32 / 75 77 07
Fax (+43)07 32 / 75 77 07 75
wolter.linz@aon.at

Poland:

Wentoprodukt
44-100 Gliwice
Tel. (+48)32 331-34-24
Fax (+48)32 729-76-53
biuro@wentoprodukt.pl

Portugal:

Safe Park Ventilação Industrial Lda.
P-2675-240 Odivelas
Tel. (+351) 21 93 / 75 265
Fax (+351) 21 93 / 86 061
safepark@netcabo.pt

Russia:

Euroclimat-Prof
RU-107082 Moskau
Tel. (+7) 4 95 / 97 57 530
Fax (+7) 4 95 / 97 57 530
gso@euroclimat.ru

Schweiz:

Anson AG Zürich
CH-8055 Zürich
Tel. (+41) 0 44 / 46 11 111
Fax (+41) 0 44 / 46 13 111
info@anson.ch

Ventra Technik AG
CH-8599 Salmsach
Tel. (+41) 0 71 / 46 11 447
Fax (+41) 0 71 / 46 11 448
ventra@bluwin.ch

Turkey:

Air Trade Centre Ltd Sti Türkiye,
TR-34418 Seyrantepe / Istanbul
Tel. (+90) 02 12 / 28 34 510
Fax (+90) 02 12 / 27 83 964
atc.turkey@airtradecentre.com

United Kingdom:

Wolter UK Ltd.
GB-B37 7UQ Solihull
Tel. (+44) 01 21 / 63 55 390
Fax (+44) 01 21 / 63 55 391
info@wolteruk.com

Middle East and North Africa

Egypt:

Tiba Engineering Industries Co.
Nasr City, Cairo
Tel. (+2) 02 / 40 22 866
Fax (+2) 02 / 40 44 771
tibaengineering@manz-group.com

Israel:

Lea Ventilation Industries Ltd.
IL-27113 Kiriyat-Bialik, Israel
Tel. (+972) 0 48 / 76 23 57
Fax (+972) 0 48 / 76 20 51
mail@lea.co.il

United Arab Emirates, Kuwait,

Lebanon:

Wolter Ventilation LLC
Energy International
P.O. Box 3562 Sharjah, UAE
Tel. (+971) 06 / 53 43 477
Fax (+971) 06 / 53 43 756
energysh@emirates.net.ae

Asia

China Mainland:

Taizhou Wolter Ventilation Co. Ltd.
Hengjie, Luqiao District
Taizhou City, Zhejiang
Tel. (+86) 576 / 26 22 666 (26 52 888)
Fax (+86) 576 / 26 56 830

Hongkong:

Wolter Asia Ltd.
Hong Kong
Tel. (+852) 0 24 / 56 01 98
Fax (+852) 0 24 / 56 02 90
info@wolter.com.hk

India:

Wolter Ventilators India Pvt. Ltd.
867 D, Block-A, Sushant Lok, Phase-I,
Gurgaon - 122009 (Haryana)
Tel. +91 124 2577797, 4261001-3
sales@wolterindia.in

Indonesia:

PT. Agung Kipas Kastara.
ID-14440 Jakarta Indonesia
Tel. +62 (0) 21 / 6667 6925, 6667 6926
Fax +62 (0) 21 / 6667 6927
indowolter@cbn.net.id

Korea:

Kaceco-Wolter
14-1, Dang-dong, Gunpo-shi, Gyeonggi-do
Tel. +82 (0) 31 / 4773 104
Fax +82 (0) 31 / 4773 132
wolter@kaceco.com / info@kaceco.com

Malaysia:

Vibrantech (M) Sdn Bhd.
47200 Petaling Jaya Selangor, Malaysia
Tel. +603 (0) 7847 3500
Fax +603 (0) 7847 3380
sales@vibrantech-sb.com

Singapore:

Wolter Pte. Ltd.
SG-569738 Singapore
Tel. (+65) 0 63 / 52 95 48
Fax (+65) 0 63 / 52 95 47
info@wolterfans.com.sg

Sri Lanka:

Sirocco Air Technologies (Pvt) Ltd.
28/12, Gemunu Mawatha, Kotuwegoda,
Rajagiriya, Sri Lanka
Tel. +94 11 7 392 010
Fax +94 11 7 392 015
suren@sairt.com

Taiwan:

Waxlink International Co., Ltd.
8F No. 218 Roosevelt Rd., Sec. 6
Taipei, Taiwan
Tel. (+886) 02 / 89 32 11 96
Fax (+886) 02 / 89 32 11 97
waxlink.tech@msa.hinet.net

Thailand:

Wolter Ventilation Co., Ltd.
Thamai Kratumban Samutsakorn 74110
Thailand
Tel. +66 (0) 3486 6555
Fax +66 (0) 3486 6599
natiphan@wolterfan.com

Australia

The Sydney Fan Company.
NSW 2147, Sydney, Australia
Tel. +61 (0) 2 / 9624 4000
Fax +61 (0) 2 / 9624 4100
sales@thesydneyfancompany.com

Wolter GmbH

Maschinen-und Apparatebau KG

Am Wasen 11
D-76316 Malsch / Germany
Tel. +49 (0) 7204/9201-0
Fax +49 (0) 7204/9201-11
www.wolter.eu
info@wolter.eu





Reference: **A09-E**, V2015/October, Printed in October, 2015