

Zhejiang Yilida Ventilator Co., Ltd.
浙江亿利达风机股份有限公司

Yilida Road, Hengjie, Luqiao District, Taizhou City, Zhejiang, China P.C: 318056
中国浙江台州市路桥区横街亿利达路

Tel : +86 576 82656000 +86 576 82658900
Fax : +86 576 82655758
E-mail : info@yilida.com

Hot Line (全球服务热线) : 400 1135 666 International Trade (国际贸易) : +86 576 82622666 www.yilida.com

Stock Code 股票代码 002686

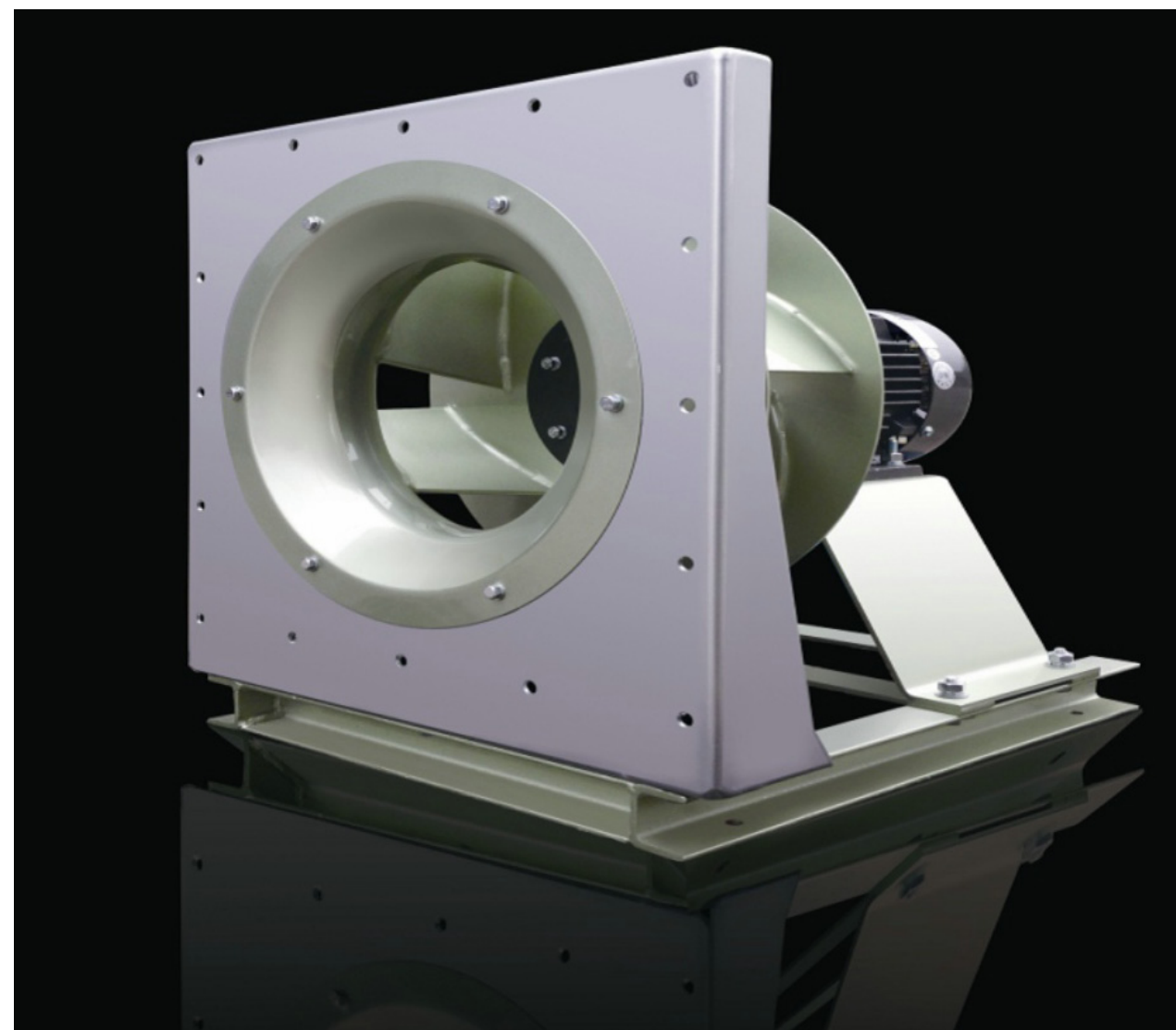

Yilida Air Conditioning Ventilation Technical Manual

SYWA Series Centrifugal Ventilators
SYWA 系列离心式空调风机

Version Number: A201401 The rights of final interpretation of this brochure belongs to Yilida.
© 2014 All Rights Reserved by Yilida

版本号 : A201401 该手册最终解释权归亿利达股份公司所有
© 2014 亿利达拥有版权并保留所有权利

Reference:SYWA-CY-2014, April 2014

本样本中所述的风机特性, 如尺寸、性能参数等, 本公司保留更改的权利, 恕不另行通知; 如有不明之处, 请来电询问。
This fan features described in the sample, such as size, performance parameters, the Company reserves the right to change without notice; if unknown place, please call us.

Yilida[®]

The Smart Air

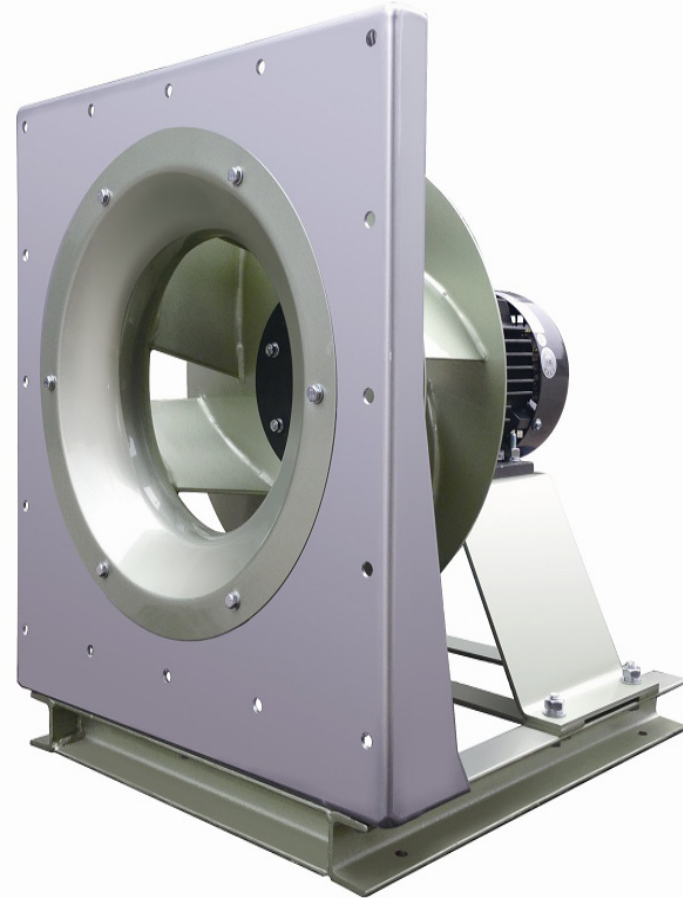

风机应用部分

Fan Applications

AMCA Introduction AMCA 介绍	002-005
Fan Basics and Applications 风机基础及应用	006-011
Fan Vibration and Balancing 风机的振动和平衡	012-018
The Basics of Sound 风机的声音基础	019-022
The Effects of Temperature and Altitude 温度与海拔对选型的影响	023-025

风机产品部分

Fan Products

SYWA	026-047
------	---------

A). 什么是AMCA 国际?

空气运动及控制协会(AMCA 国际), 是一家非盈利性的国际性组织, 它的成员大多是世界各国与空气系统有关的生产商, 涉及产品主要包括(但也不仅限于): 工商业和家用的风机、百叶窗、风阀、空气幕、空气流量测量装置、噪声衰减器及其它空气系统组件。

AMCA 的使命是促进空气运动及控制行业与公众利益一致并健康发展。AMCA 国际是一种非常有价值的资源, 同时也是行业自律的强有力组织。人们不论是购买还是指定风机、风阀和百叶窗, 都一定要充分了解 AMCA 国际认证额定值印章的价值。

在过去的 90 年中, AMCA 国际代表空气运动及控制行业发展的行业领军者, 为其会员提供下列有利价值的服务:

- 1) 认证额定值程序
- 2) 独一无二的国家级检测实验室
- 3) 参与标准的制定
- 4) AMCA 认可的独立实验室 (在新加坡和韩国)
- 5) 行业统计和预测报告

A). What is AMCA International?

The Air Movement and Control Association (AMCA International), Inc. is a not-for-profit international association of the world's manufacturers of related air system equipment, primarily, but not limited to: fans, louvers, dampers, air curtains, airflow measurement stations, acoustic attenuators, and other air system components for the industrial, commercial and residential markets.

The association's mission is to promote the health and growth of the air movement and control industry consistent with the interest of the public. AMCA International is a valuable resource and a strong means of self regulation for our industry. People who buy and specify fans, dampers, and louvers need to be aware of the value of the AMCA International Certified Ratings Seal.

During the last 90 years of representing the air movement and control industry, AMCA International has provided value to its membership with the following services:

- 1) Certified Ratings Program
- 2) Unique state-of-the art testing laboratory
- 3) Participation in the development of standards
- 4) Independent AMCA accredited laboratories in Singapore, Korea
- 5) Industry statistics and forecasting reports

B). 认证额定值程序 (CRP)

1) AMCA 国际的认证额定值程序(CRP), 保证产品系列已经过测试, 及其额定值已达到 AMCA 国际的测试标准和额定要求。

2) 当产品经过测试, 并且其样本提交给 AMCA 国际的工作人员批准后, AMCA 的性能印章会显示在样本和设备上。要维持额定值的认证, 每一个经授权的产品系列都要接受 3 年一次的重复检测。发布的性能参数都经过核实为准确并有效的。

3) AMCA 国际的认证额定值印章向空气运动及控制设备的采购员、专业人士和终端用户保证, 生产商公布的额定值是可靠和准确的。

4) AMCA 的认证额定值程序向采购员和专业人士保证, 各竞争者的额定值都是基于标准的测试方法和程序得出, 并由 AMCA 国际作为一个公平的权威机构来进行审核。

5) 所有 AMCA 认证的产品都列入网站, 以便您可以验证出您购买的产品是否在行列中。你在购买之前, 请检查 AMCA 在线目录的认证产品 www.amca.org。

B). Certified Rating Program (CRP)

1) AMCA International's Certified Ratings Program (CRP) assures that a product line has been tested and rated in conformance with AMCA International's test standards and rating requirements.

2) Performance seals may be displayed in literature and on equipment after a product has been tested and its cataloged ratings have been submitted to and approved by AMCA International's staff. To maintain a ratings certification, each licensed product line is subject to retesting every 3 years. Published performance is checked for accuracy and validity.

3) An AMCA Certified Ratings Seal gives the buyer, specifier, and end-user of air movement and control equipment assurance that published ratings are reliable and accurate.

4) The AMCA certified ratings program assures buyers and specifiers that competitors' ratings are based on standard test methods and procedures, and are subject to review by AMCA International as an impartial authority.

5) All AMCA certified products are listed on line, so you can verify that the product you are buying is listed. Before you buy, check out the AMCA online Directory of Certified Products at www.amca.org.

C) 风机的测试及标准

C). Fans Testing and Standards

AMCA 国际的实验室可以对风机进行以下的测试:

1) 风机的空气性能测试包括:

- 风机性能的发展。
- 流量、压力、功率和效率的测量。

适用于空气性能测试的测试标准,包括:

- AMCA 标准 210-07, 实验室测试风机气动性能额定值认证的方法。
- AMCA 标准 220-05, 空气幕机组的测试方法。
- AMCA 标准 230-07, 实验室测试空气循环风机额定值的方法。
- AMCA 标准 240-06, 实验室测试正压通风机额定值的方法。

2) 风机的声音测试包括:

- 进口的声功率。
- 出口的声功率。
- 总声功率。

适用于声音测试的测试标准,包括:

- AMCA 标准 300-08, 混响室测试风机声音的方法。

3) 风机的能源效率测试包括:

- 风机效率等级 (FEG) 对风机的效率进行分级。

适用于风机的能源效率测试的测试标准,包括:

- AMCA 标准 205-10, 风机能源效率分级。

1) Air Performance Testing includes:

- Development of the fan curves.
- Measurement of airflow, pressure, power and efficiency.

Test standards that apply to air performance testing include:

- AMCA 210-07, Laboratory Methods of Testing Fans for Aerodynamic Performance Rating.
- AMCA 220-05, Test Methods for Air Curtain Units.
- AMCA 230-07, Laboratory Methods of Testing Air Circulator Fans for Rating.
- AMCA 240-06, Laboratory Method of Testing Positive Pressure Ventilators for Rating.

2) Sound Testing includes:

- Inlet sound power.
- Outlet sound power.
- Total sound power.

Test standards that apply to air performance testing include:

- AMCA 300-08, Reverberant Room Method for Sound Testing of Fans.

3) Energy Efficiency Testing includes:

- The fans shall be classified for their fan efficiency by using the Fan Efficiency Grade (FEG).

Test standards that apply to air performance testing include:

- AMCA 205-10, Energy Efficiency Classification for Fans.

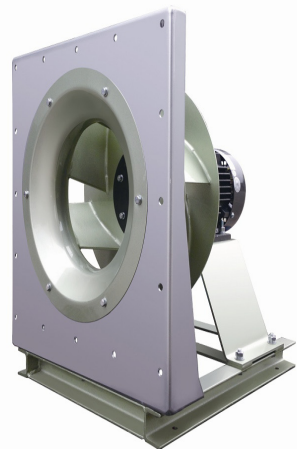

D). Relationship between Yilida and AMCA International, Inc.

D) 亿利达与 AMCA 国际的关系

1) 亿利达是 AMCA 国际的会员单位。

2) 亿利达建有国内首家 AMCA 标准实验室——按 AMCA 标准建设的全性能实验室。

3) 大部分的产品都通过 AMCA 认证额定值程序 (CRP) 的测试, 相应的样本都获得 AMCA 国际的工作人员批准, 这些产品及其样本已被批准使用 AMCA 国际的认证额定值印章。

4) 亿利达获得的认证额定值印章, 包括: 风机的空气性能, 风机的声音, 风机效率等级 (FEG)。

注意:

1) 有些生产厂商的印刷品中有下列类似阐述“按照 AMCA 标准进行测试”, 但请注意这与“产品被获准使用 AMCA 国际的认证额定值印章”有本质区别。印有类似语句的印刷品仅仅表明该产品采用 AMCA 公布的标准进行测试, 但是其测试的数据不会被 AMCA 承认。

2) 另一个容易引致误会的方面是 AMCA 国际的认证额定值印章与 AMCA 会员证书之间的差异。有些生产厂商会将 AMCA 会员证书印在产品目录上, 这容易让人误解为其产品已通过 AMCA 的测试及认证。红白的 AMCA 会员证书仅仅代表其为 AMCA 国际的会员, 只有蓝黄色和绿黄色的认证额定值印章, 才表明该产品是通过 AMCA 认证额定值程序 (CRP) 的测试, 并被批准使用 AMCA 国际的认证额定值印章。如图 1 所示。

1) Yilida is a member of AMCA International, Inc.

2) Yilida has build the first AMCA Standard Laboratory in China. The laboratory was built in accordance to the AMCA Standard.

3) Most of the products are tested and certified by AMCA Certified Rating Program (CRP), and their catalog ratings are approved by AMCA International's staff. All these products and their catalogs are approved to use the AMCA International Certified Ratings Seal.

4) The Certified Rating Seals include: Air Performance, Sound and Fan Efficiency Grade (FEG).

Note:

1) Some manufacturers have printed the following statement: "tested in accordance with AMCA standards" in their catalogs. Please note that there are essentially different from the statement of " the products are approved to use the AMCA International Certified Ratings Seal". These manufactures statements mean that their products are tested in accordance with AMCA Standards, but the tested data are not recognized and approved by the AMCA International.

2) Another statement that can easily lead to misunderstanding is the difference between the "AMCA Interational Certified Ratings Seal" and the "AMCA Membership Certificate". Some manufacturers have printed the "AMCA Membership Certificate" in their catalogs. This is misleading to let people believe that their products have tested and certified by AMCA. The "AMCA Membership Certificate" (red and white color) indicates that the manufacturer is a member of the AMCA International only. Only the "AMCA International Certified Ratings Seal" (yellow and green, yellow and blue color) symbols indicates that the products have been tested through the AMCA International Certified Rating Program and have been approved to use the "AMCA International Certified Ratings Seal".(Fig.1)



图1 Fig.1

本公司承诺样本中贴有 AMCA 国际的认证额定值印章 的风机, 性能都已经通过 AMCA 认证额定值程序 (CRP) 的测试, 并被批准使用 AMCA 国际的认证额定值印章。

Yilida committed that all fans and its catalogs affixed with the AMCA International Certified Ratings Seal. The fans are tested and certified by AMCA Certified Rating Program (CRP) and are approved to use the AMCA International Certified Rating Seal.

风机定律

Fan Laws

该样本中风机性能均指在标准状态下的性能，即风机的气体状态为：

The fan performance in this catalogue denotes the performance under the standard air conditions. The standard air conditions are as follows:

空气压力	Air pressure	P = 101.325 kPa
空气温度	Air temperature	t = 20 °C
空气密度	Air density	ρ = 1.2 kg/m ³

风机定律方程式：

Fan Laws Equations:

$$\frac{q_{v2}}{q_{v1}} = \frac{n_2}{n_1} \times \left(\frac{D_2}{D_1}\right)^3 \quad \frac{p_2}{p_1} = \left(\frac{n_2}{n_1}\right)^2 \times \left(\frac{D_2}{D_1}\right)^2 \times \left(\frac{\rho_2}{\rho_1}\right) \quad \frac{P_2}{P_1} = \left(\frac{n_2}{n_1}\right)^3 \times \left(\frac{D_2}{D_1}\right)^5 \times \left(\frac{\rho_2}{\rho_1}\right)$$

应用一：风机转速的变化。

Application 1: Change in Fan Speed.

a) 当风机尺寸、管网系统及空气密度都不变时，可得：

a) When the fan, the airflow system and the air density remain unchanged:

$$\frac{q_{v2}}{q_{v1}} = \frac{n_2}{n_1} \quad \frac{p_2}{p_1} = \left(\frac{n_2}{n_1}\right)^2 \quad \frac{P_2}{P_1} = \left(\frac{n_2}{n_1}\right)^3$$

★ 注：这个定理常用于解决现场风量过大或者风量不足的情况。

★ Note: This application is normally used to fix the airflow problems (too big or too small) at site.

例 1：某工程项目需要一台后向离心风机来送风，风量为 25000 m³/h，静压为 730 Pa。经选型，可得风机型号为 SYQ630R，转速为 1220 r/min，轴功率为 7.47 kW (电机功率为 11 kW)。现场要求风量大于原来设计风量，要求风量增加到 30000 m³/h。

E.g. 1: A project needs a backward inclined centrifugal fan to supply air, its airflow is 25,000 m³/h and the static pressure is 730 Pa. After selection, the fan is SYQ630R, the fan speed is 1220 r/min and the shaft power is 7.47 kW (the motor power is 11 kW). Now the site needs to increase the airflow to 30,000m³/h. Find the new fan speed, static pressure and the shaft power.

求风机新的转速，静压及轴功率。

$$\frac{q_{v2}}{q_{v1}} = \frac{n_2}{n_1} \Rightarrow n_2 = \frac{30000}{25000} \times 1220 = 1464 \text{ r/min}$$

$$\frac{p_2}{p_1} = \left(\frac{n_2}{n_1}\right)^2 \Rightarrow p_2 = \left(\frac{1464}{1220}\right)^2 \times 730 = 1051 \text{ Pa}$$

$$\frac{P_2}{P_1} = \left(\frac{n_2}{n_1}\right)^3 \Rightarrow P_2 = \left(\frac{1464}{1220}\right)^3 \times 7.47 = 12.91 \text{ kW}$$

SYQ630R 风机的最高转速为 1700 r/min。当风机转速提高到 1464 r/min，SYQ630R 的风机能满足要求。当前风机的轴功率提高到 12.91 kW。原有的 11 kW 电机已不能满足要求，需更换电机。

The maximum fan speed of SYQ630R is 1700 r/min, so it is not a problem for the fan speed to run 1464 r/min. Now, the shaft power is increased to 12.91 kW, so the original 11 kW motor cannot be used, the motor needs to be changed.

★ 注意：当现场需要增加风量时，必须注意

- (1) 风机新的转速不能超过风机的最高转速。
- (2) 如原有的电机功率不能满足新的轴功率时，就需要更换电机。

★ NOTE: When the customer site needs to increase the airflow, please pay attention

- (1) The new fan speed cannot exceed the maximum fan speed.
- (2) If the original motor cannot meet requirement of the new shaft power, then the motor needs to be replaced.

例 2：在同样的情况下，客户要求增加风量，但不想再投资去更换电机，求此 11 kW 电机的条件下，允许增加多少转速？在这个新的转速下，风量和静压是多少？

E.g. 2: In the same case, the client requests for additional airflow, but do not want to invest to replace the motor. Under the same 11 kW motor conditions, what is the new fan speed? And in this new speed, what is the airflow and static pressure?

解：11 kW 的电机功率减去 10% 的安全系数得轴功率为 9.9 kW。

If the safety factor is 10%, the shaft power will be 9.9 kW.

$$\frac{P_2}{P_1} = \left(\frac{n_2}{n_1}\right)^3 \Rightarrow n_2 = \left(\frac{P_2}{P_1}\right)^{\frac{1}{3}} \times n_1 = \left(\frac{9.9}{7.47}\right)^{\frac{1}{3}} \times 1220 = 1340 \text{ r/min}$$

$$\frac{q_{v2}}{q_{v1}} = \frac{n_2}{n_1} \Rightarrow q_{v2} = \frac{1340}{1220} \times 25000 = 27460 \text{ m}^3/\text{h}$$

$$\frac{p_2}{p_1} = \left(\frac{n_2}{n_1}\right)^2 \Rightarrow p_2 = \left(\frac{1340}{1220}\right)^2 \times 730 = 881 \text{ Pa}$$

∴ 如果不更换电机的情况下，风量只能从 25000 m³/h 增加到 27460 m³/h。

If the motor is not replaced, then the airflow can only be increased from 25000 m³/h to 27460 m³/h.

应用二：气体密度的变化。

Application 2: Change in Air Density.

(a) 当风机尺寸，管网系统及风机转速都不变时，可得：

(a) When the fan size, the airflow system and the fan speed remain unchanged:

$$q_{v2} = q_{v1} \quad \frac{p_2}{p_1} = \frac{\rho_2}{\rho_1} \quad \frac{P_2}{P_1} = \frac{\rho_2}{\rho_1}$$

(b) 当风机尺寸，管网系统及压力都不变时，可得：

(b) When the fan, the airflow system and the pressure remain unchanged:

$$p_2 = p_1 \Rightarrow \left(\frac{n_2}{n_1}\right)^2 = \left(\frac{\rho_1}{\rho_2}\right) \Rightarrow \left(\frac{n_2}{n_1}\right) = \left(\frac{\rho_1}{\rho_2}\right)^{\frac{1}{2}} \quad \frac{q_{v2}}{q_{v1}} = \frac{n_2}{n_1} = \left(\frac{\rho_1}{\rho_2}\right)^{\frac{1}{2}}$$

$$\frac{P_2}{P_1} = \left(\frac{n_2}{n_1}\right)^3 \times \left(\frac{\rho_2}{\rho_1}\right) = \left(\frac{\rho_1}{\rho_2}\right)^{\frac{3}{2}} \times \left(\frac{\rho_2}{\rho_1}\right) = \left(\frac{\rho_1}{\rho_2}\right)^{\frac{1}{2}} \Rightarrow \frac{P_2}{P_1} = \frac{q_{v2}}{q_{v1}}$$

(c) 当风机尺寸，管网系统及空气质量流量 (q_m) 都不变时，可得：

(c) When the fan, the airflow system and the mass flow rate (q_m) remain unchanged:

$$q_m = q_v \times \rho \quad q_{m2} = q_{m1} \Rightarrow q_{v2} \times \rho_2 = q_{v1} \times \rho_1$$

$$\frac{q_{v2}}{q_{v1}} = \frac{\rho_1}{\rho_2} \quad \frac{n_2}{n_1} = \frac{\rho_1}{\rho_2} \quad \frac{p_2}{p_1} = \frac{\rho_1}{\rho_2} \quad \frac{P_2}{P_1} = \left(\frac{\rho_1}{\rho_2}\right)^2$$

★ 注：风机样本中的风机性能曲线都是以标准空气为基础的，这个定理是用于高海拔高度或高温度的情况，空气密度有变化时，选择风机的基础。

★ Note: The fan performance curves in the catalog are measured under the standard air condition. This application is used for the selection of the fans that running in the high altitude or in the high temperature condition, when there is a change in the air density.

例 3: 某工厂需要一台风机用于排除一个锅炉产生的 20000 m³/h 的 120°C 的高温气体, 其静压为 450 Pa。求风机所需的轴功率。

解: 120°C 的空气密度 = 0.9 kg/m³
标准空气的密度 = 1.2 kg/m³

$$q_{v2} = q_{v1} = 20000 \text{ m}^3/\text{h}$$

20000 m³/h 风量及静压 600 Pa, 标准空气工况选型, 得风机 SYQS900E。转速为 770 r/min, 轴功率为 4.93 kW(电机为 5.5 kW)。
当用于 120°C 的高温空气,

$$P_2 = \frac{0.9}{1.2} \times 4.93 = 3.7 \text{ kW}$$

∴ 所需轴功率为 3.7 kW。

应用三: 风机尺寸的变化。

(a) 当风机转速及空气密度都不变时, 可得:

$$\frac{q_{v2}}{q_{v1}} = \left(\frac{D_2}{D_1}\right)^3 \quad \frac{p_2}{p_1} = \left(\frac{D_2}{D_1}\right)^2 \quad \frac{P_2}{P_1} = \left(\frac{D_2}{D_1}\right)^5$$

(b) 当风机的轮缘线速度及气体密度都不变时, 可得:

$$u_2 = u_1 \quad n_2 D_2 = n_1 D_1 \quad \therefore \frac{n_2}{n_1} = \frac{D_1}{D_2} \Rightarrow \frac{q_{v2}}{q_{v1}} = \left(\frac{D_2}{D_1}\right)^2 \quad p_2 = p_1 \quad \frac{P_2}{P_1} = \left(\frac{D_2}{D_1}\right)^2 = \frac{q_{v2}}{q_{v1}}$$

★ 注: 这个定理一般为风机设计人员所用, 很少用于现场。

例 4: 一家风机制造厂商想把直径为 355 mm 风机的性能数据扩大应用于直径为 710 mm 的风机。355 mm 风机在风量 8000 m³/h, 静压为 300 Pa 时, 它的转速为 784 r/min, 轴功率为 1.33 kW。轮缘线速度为 14.57 m/s。对应一个 710 mm 风机, 在相同的转速 (784 r/min) 时, 求它对应的风量, 静压, 轴功率及轮缘线速度。

$$\frac{q_{v2}}{q_{v1}} = \left(\frac{D_2}{D_1}\right)^3 \quad q_{v2} = \left(\frac{710}{355}\right)^3 \times 8000 = 64000 \text{ m}^3/\text{h}$$

$$\frac{P_2}{P_1} = \left(\frac{D_2}{D_1}\right)^5 \quad P_2 = \left(\frac{710}{355}\right)^5 \times 1.33 = 42.56 \text{ kW}$$

E.g. 3: A factory needs a fan to draw high temperature air from an oven which is delivering 20,000 m³/h of 120 °C air against 450 Pa static pressure. Find the shaft power required for the fan.

The air density at 120 °C = 0.9 kg/m³
The standard air density = 1.2 kg/m³

$$p_2 = \frac{1.2}{0.9} \times 450 = 600 \text{ Pa}$$

Using the airflow 20,000 m³/h and the static pressure 600 Pa, under the standard air condition, the fan selected is SYQS 900E, the fan speed is 770 r/min, the shaft power is 4.93 kW (motor is 5.5 kW).

When running at 120 °C high temperature air,

The shaft power required is 3.7 kW.

Application 3: Change in Fan Size.

(a) When the fan speed and the air density remain unchanged:

$$\frac{q_{v2}}{q_{v1}} = \left(\frac{D_2}{D_1}\right)^3 \quad \frac{p_2}{p_1} = \left(\frac{D_2}{D_1}\right)^2 \quad \frac{P_2}{P_1} = \left(\frac{D_2}{D_1}\right)^5$$

(b) When the tip-speed of fan and the air density remain unchanged:

★ Note: This application is mostly used by the fan designers, it is rarely used at site.

E.g. 4: A fan manufacturer wishes to project data obtained for a 355 mm fan to a 710 mm fan. At one operating point, the airflow is 8000 m³/h and the static pressure is 300 Pa, the fan speed of the 400 mm fan is 784 r/min, the shaft power is 1.33 kW and its tip-speed is 14.57 m/s.

What will the projected airflow, static pressure, shaft power and tip-speed be for a 710 mm fan at the same fan speed (784 r/min)?

$$\frac{p_2}{p_1} = \left(\frac{D_2}{D_1}\right)^2 \quad p_2 = \left(\frac{710}{355}\right)^2 \times 300 = 1200 \text{ Pa}$$

$$\frac{u_2}{u_1} = \frac{D_2}{D_1} \quad u_2 = \left(\frac{710}{355}\right) \times 14.57 = 29.14 \text{ m/s}$$

风机性能曲线

由于不同类型和不同尺寸的风机各有特点, 风机制造商必须制定风机性能曲线。风机性能曲线是风机运转的图形表示, 通常它包括从自由输送(即无阻碍的气流)到无输送(即气流完全被密封的系统)的全部范围, 气体的流量 q_v 可由以下一个或多个参数表示:

静压 p_{sF}

全压 p_{tF}

功率 P

风机静效率 η_{sF}

风机全压效率 η_{tF}

气体密度(ρ)、风机尺寸、以及转速(n) 通常在曲线中称为常量, 并应加以标注。

一个典型的风机性能曲线如图2。这些曲线一般均按照适当的工业测试标准进行实验室试验。例如国际空气运动与控制协会 (AMCA International)。

风机定律用于在其他转速和风机尺寸时测定轴功率和性能特点, 通常情况下, 就如之前提到的, 只需测试一个型号风机的尺寸和转速, 就能确定该系列风机的效能。

Fan Performance Curves

Since each type and size of fan has different characteristics, fan performance curve must be developed by the fan manufacturers.

A fan performance curve is a graphical presentation of the performance of a fan. Usually it covers the entire range from free delivery (no obstruction to flow) to no delivery (an air tight system with no air flowing). One or more of the following characteristics may be plotted against volume flow rate (q_v):

Statics Pressure	p_{sF}
Total Pressure	p_{tF}
Power	P
Fan Static Efficiency	η_{sF}
Fan Total Efficiency	η_{tF}

Air density(ρ), fan size, and fan speed(n) are usually constant for the entire curve and must be stated.

A typical fan performance curve is shown in Fig.2. Generally, these curves are determined by laboratory tests, conducted according to an appropriate industry test standard, e.g. Air Movement and Control Association International Inc.(AMCA). The "Fan Laws" are used to determine the brake horsepower and performance characteristics at other speeds and fan sizes. Normally, as mentioned before, only one fan size and speed must be tested to determine the capacity for a given "family" of fans.



图2 风机性能曲线图

Fig.2 Fan Performance Curve

系统阻力曲线

System Resistance Curve

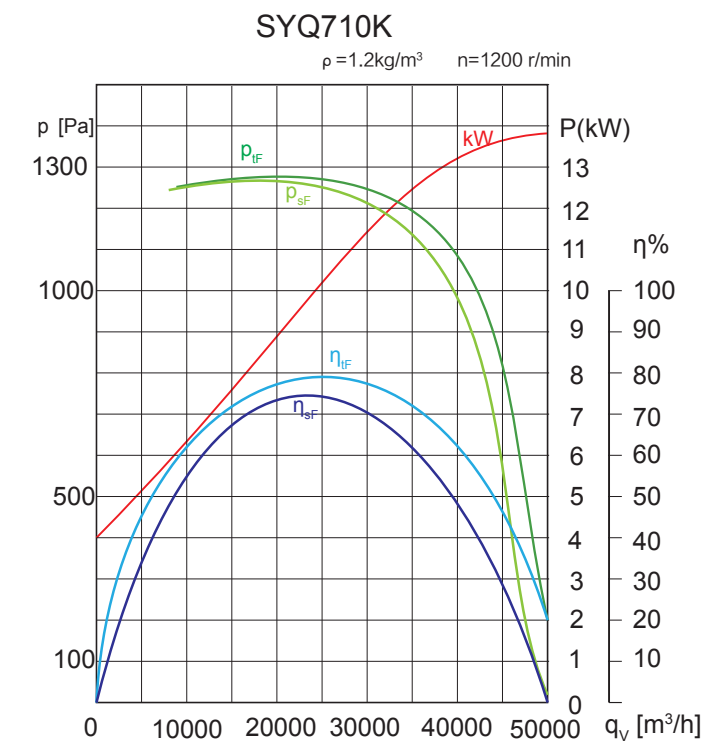
1) 管网系统的阻力是指过滤器、冷热盘管、挡板、风阀及管道等所有压力损失的总和。系统阻力曲线（图3）仅绘出气体通过系统所需的压力。

1) System resistance is the total sum of all pressure losses through filters, coils, dampers, and duct work. The system resistance curve (Fig.3) is simply a plot of the pressure that is required to move the air through the system.



图3 系统阻力曲线

Fig.3 System Resistance Curve

$$\frac{P_{sF2}}{P_{sF1}} = \left(\frac{q_{v2}}{q_{v1}}\right)^2 = \left(\frac{2000}{1000}\right)^2 = \frac{4}{1}$$

2) 管网系统的阻力方程:

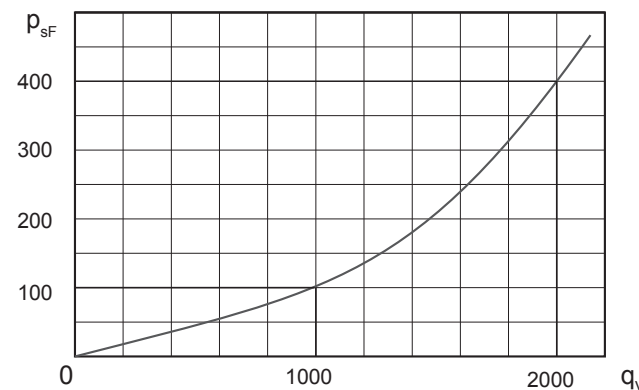
2) The pressure equation of a airflow system is:

$$p = k(q_v)^2$$

管网系统所需的功率公式:

The power required for the air moving through the airflow system is:

$$P = \frac{q_v \times p}{3600 \times 1000}$$

3) 例如, 考虑一个 1000 m³/h 的系统, 阻力总和为 100Pa。如果 q_v 加倍, P_sF 静压阻力则将增至 400Pa, 如图 3 中比例的平方值所示。

3) For example, consider a system handling 1000 m³/h with a total resistance of 100 Pa SP. If the q_v is doubled, the SP resistance will increase to 400Pa, as shown by the squared value of the ratio given in Fig.3.

4) 但是当过滤器有污物, 盘管开始凝结水分, 或出口调节板改变了位置时, 这时曲线就会有变化。

4) This curve changes, however, as filters load with dirt, coils start condensing moisture, or when outlet dampers change in position.

5) 工况点: 图 4 所示的风机在系统中运行的工况点, 是由系统阻力曲线和风机转速性能曲线相交点来确定。每个风机只按它自己的性能曲线操作, 如果原设计系统阻力与安装时的阻力不同, 工况点将会变化, 静压和输送风量将与计算不同。

5) Operating point: The operating point (Fig.4) at which the fan and system will perform is determined by the intersection of the system resistance curve and fan performance curve. Note that every fan operates only along its performance curve. If the system resistance designed is not the same as the resistance in the system installed, the operating point will change and the static pressure and volume delivered will not be as calculated.



图4 工况点

Fig.4 Operating Point

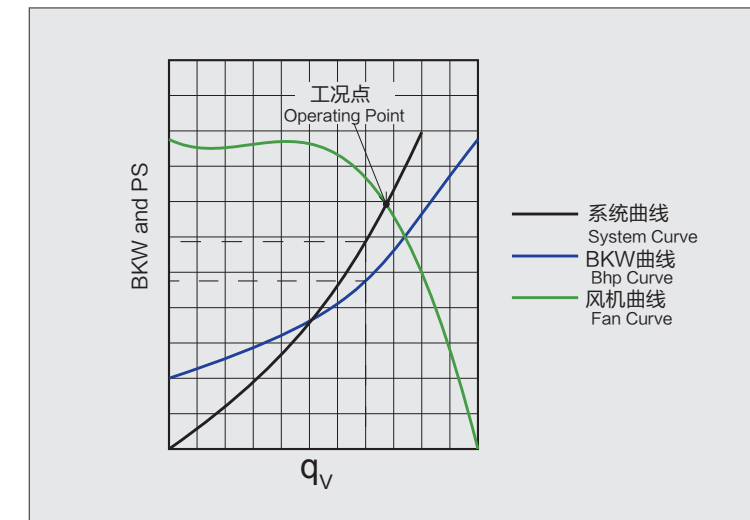

图5 系统阻力曲线的变化——风量减少

Fig.5 Change In System Resistance Curve—Air Volume Reduced

6) 如果实际系统比预先设计的有更多的阻力损失, 因而气体流量减少, 静压增加。(图 5) 功率曲线的形状显示轴功率减少。

6) If the actual system has more pressure loss than predicted in the design. Such, air volume is reduced and static pressure is increased. (Fig.5) The shape of the kW curve typically would result in a reduction in BkW.

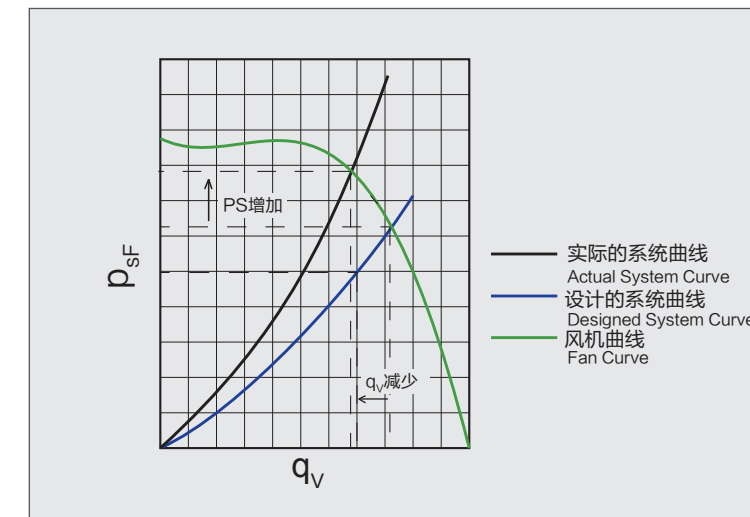
7) 在很多情况下, 风机的实际输出与计算输出之间有差别, 它是由于系统阻力的变化而不是风机或电机的原因。通常是在错误的交点上获得了静压值, 并认为当静压高于设计值时, Q 也会高于设计值, 图 5 显示为何这种假设完全错误的。

7) In many cases where there is a difference between actual and calculated fan output, it is due to change in system resistance rather than any shortcomings of the fan or motor. Frequently the mistake is made when taking the static pressure reading across the fan and concluding that if the static pressure is at or above design requirements the volume is also at or above design requirements. Fig.5 shows why the assumption is completely invalid.

风机振动

Fan Vibration

不平衡的风机在运转时会引起振动,这种振动会使轴承、轴套等产生过度的磨损,大大降低它们的使用寿命。

振动又会在支座及支架中造成非常不利的交替应力,并最终将其完全破坏,而且机器的性能也会由于功率被支撑结构吸收而降低。

此外,振动还可以通过地板传递到邻近的机器,严重地影响其精度和正常的功能。

引起风机振动的原因有很多种,常见的情况如下:

- (a) 转子(如风机叶轮、轴或皮带轮等)不平衡
- (b) 联轴器不对中
- (c) 基础、支座、支架等刚度不够
- (d) 风机进口处及出口处的气流不均匀
- (e) 轴承的润滑油不够等等

其中,引起风机振动最大的原因是转子的动不平衡造成的。

Unbalanced fan can cause vibration during operation. This vibration in turn may cause excessive wear in shafts, bearings, bushings, etc., and greatly reduce their service lives.

The vibration will then create a very negative alternating stress in structural supports and frames which may eventually lead to their complete destroy. And the fan's performance will decrease due to the power absorbed by the supporting structure. In addition, the vibration can also be transmitted through the floor to the nearby machines, which can seriously affect their accuracy and proper function.

The fan vibration is caused by a variety of reasons, the commons are as follows:

- (a) The unbalanced rotor (eg: fan Wheel, shaft, pulley etc.).
- (b) The coupling is misaligned.
- (c) The rigidity of the foundation, structural support, frame is not enough.
- (d) The uneven airflow passing through the inlet or the outlet of the fan.
- (e) Insufficient lubrication of the bearings, and so on.

The main cause of the fan vibration is the unbalanced rotor.

风机的平衡

Fan Balancing

风机经过动平衡校验的作用是:

- (a) 提高风机的性能
- (b) 减小振动
- (c) 减小噪声
- (d) 提高轴承的使用寿命
- (e) 减少对使用者的干扰及疲劳
- (f) 减少能源的损失

The effects of the fan trim balancing are:

- (a) To improve the fan performance
- (b) To reduce the vibration
- (c) To reduce the noise
- (d) To improve the lifetime of the bearings
- (e) To reduce the fatigue and the disturbance of the operators
- (f) To reduce the energy losses

转子的平衡精度等级

Balance Quality Grades for Rotors

考虑到技术的先进性和经济上的合理性,国际标准化组织(ISO)于1940年制定了世界公认的ISO 1940平衡精度等级。它将转子平衡质量等级分为11个级别,每个等级之间以2.5倍为增量,平衡机从要求最高的G0.4到要求最低的G4000。每个等级的单位为mm/s。

Taking into account the advanced technology and economic rationality, in year 1940, the International Organization for Standardization (ISO) have formulated the Balance Quality Grades for Rotors. The Balance Quality Grades for Rotors is divided into 11 grades, each grade is increased by 2.5 times. The balancing machine is requested to balance from the highest grade G0.4 to the lowest grade G4000. The unit of the grade is mm/s.

表 1- 转子的平衡精度等级

Table 1 - Guidance for balance quality grades for rotors in a constant (rigid) state

转子类型举例 Machinery types: General examples	平衡精度等级 Balance quality grade G	振幅 Magnitude $e_{per} \cdot \Omega$ mm/s
刚性安装的船用柴油机的曲轴驱动件; 刚性安装的大型四冲程发动机的曲轴驱动件。 Crankshaft drives of marine diesel engine with rigid installation; Crankshaft drives of large-scale four-stroke engine with rigid installation.	G630	630
刚性安装的高速四缸柴油机的曲轴驱动件。 Crankshaft drives of high-speed four-stroke diesel engine with rigid installation.	G250	250
六缸和多缸柴油机的曲轴驱动件; 汽车、货车和机车用的(汽油、柴油)发动机整机。 Crankshaft drives of 6-stroke or multiple-stroke diesel engine. Complete reciprocating engines for cars, trucks and locomotives(gasoline, diesel oil).	G100	100
汽车车轮、箍轮、车轮整体; 汽车、货车和机车用的发动机的曲轴驱动件。 Cars: wheels, wheel rims, wheel sets, drive shafts; Crankshaft drives of the cars, trucks and locomotives motor.	G 40	40
粉碎机、农业机械的零件; 汽车、货车和机车用的(汽油、柴油)发动机个别零件。 Components of crushing machines and agricultural machinery; Motor individual component of cars, truck and locomotive(gasoline, diesel oil).	G 16	16
海轮(商船)主蜗轮机的齿轮; 离心分离机、泵的叶轮; 风扇; 航空燃气涡轮机的转子部件; 飞轮; 机床的一般零件; 普通电机转子; 特殊要求的发动机的个别零件。 Main turbine gear of seacraft(merchantman); Centrifugal machine, pump Wheel; Fans; Rotors of Aircraft gas turbines; Flywheel; General component of machine-tools; General motor rotor; Individual component of special requirement motor.	G 6.3	6.3

从表中, ISO 建议风机的平衡质量等级为 G6.3。
但为了使风机的性能更好, 寿命更长久, 亿利达风机将内控的平衡精度等级定位为 G2.5。

In the table, the ISO suggested that the balance quality grade for the fans is G6.3.
However, in order to have a better performance and a longer lifetime of the fans, YILIDA has balanced all the fans to a higher grade G2.5.

燃气和蒸气涡轮, 包括海轮(商船)主涡轮刚性涡轮发电机转子; 透平增压器; 机床驱动件; 特殊要求的中型和大型电机转子; 小电机转子; 涡轮泵。 Gas and steam turbine, including ri motor rotor of rigid turbine; Turbo-chargers; Mechine tool actuator; Midsize and large size motor rotor with special requirement; Minitype motor rotor; Turbine pump.	G 2.5	2.5
磁带录音机及电唱机驱动件; 磨床驱动件; 特殊要求的小型电机。 Audio and video drives; Grinding machine drives; Minitype drives with special requirement.	G 1	1
精密磨床的主轴、磨轮及电枢、回转仪。 Spindles and drives of high-precision grinder; drives and gyroscopes.	G 0.4	0.4

注1: 通常的大部分组长完成的转子是分类的, 根据特定的用途, 高一个的等级或低一个的等级能用来替换, 对于组件, 请参阅第九条。
注2: 在不指明或不言自明(如曲轴驱动件)的情况下, 所有转子都是运转的。
注3: 对于因设置条件(平衡机、模具)的限制, 请参见5.2中的注4和注5。
注4: 对于所选的平衡质量等级的其他信息, 请参阅图2。基于经验, 其包含了普遍的使用范围(使用速度和平衡质量等级G)
注5: 曲轴的驱动器可能包括曲轴, 飞轮, 离合器, 减震器, 旋转连杆的部分。原有的不平衡曲轴驱动器理论上可以不平衡;固有的平衡曲轴驱动器理论上可以平衡。
注6: 对于某些机器, 可能存在具体说明平衡公差的国际标准(见参考书目)。

NOTE 1 Typically completely assembled rotors are classified here. Depending on the particular application, the next higher or lower grade may be used instead. For components, see Clause 9.
NOTE 2 All items are rotating if not otherwise mentioned (reciprocating) or self-evident (e.g. crankshaft drives).
NOTE 3 For limitations due to set-up conditions (balancing machine, tooling), see Notes 4 and 5 in 5.2.
NOTE 4 For some additional information on the chosen balance quality grade, see Figure 2. It contains generally used areas (service speed and balance quality grade G), based on common experience.
NOTE 5 Crankshaft drives may include crankshaft, flywheel, clutch, vibration damper, rotating portion of connecting rod. Inherently unbalanced crankshaft drives theoretically cannot be balanced; inherently balanced crankshaft drives theoretically can be balanced.
NOTE 6 For some machines, specific International Standards stating balance tolerances may exist (see Bibliography).

平衡机的作用

为了测不平衡量并确定其位置, 平衡机是必要的。平衡机所测出的数据是反映转子的质量分布, 由此可以改变转子的质量分布使转子达到更平衡。

The Purpose of Balancing Machine

A balancing machine is necessary to detect, measure and determine the location of unbalance. The data measured by the balancing machine can be used to change the mass distribution of a rotor. When measuring is done accurately, it can balance the rotor.

允许的剩余不平衡量

由于任何转子不可能做到 100% 的平衡, 因此剩余不平衡量总是存在的。

Permissible Residual Unbalance

Since it is not possible to have 100% balancing, so there must be some unbalance in tolerance.

一个圆轮的半径为 R(mm), 重量为 M(kg), 在圆轮上有一超重点 m(g)。当圆轮旋转时, 有一离心力 F 作用在 m 上, 并且传递到圆轮的轴上。结果, 轴中心由原来的静止位置产生位移, 并围绕其原来位置形成一个很小的圆。这个位移称为偏心率, 见下图

A wheel with radius R (mm) and weight M (kg), has a little overweight m (g) at a point. When the wheel is rotating, a centrifugal force F acts upon m and is transmitted to the centre axis. As the result, the axis is displaced from its original position and rotate around its original position to form a small circle. This displacement is called the eccentricity. See below

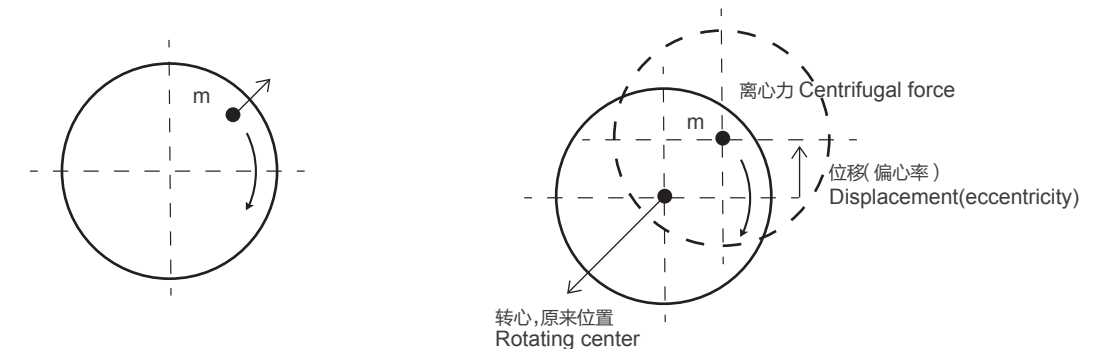

这偏心距 e_{per} 用下列公式表示它与圆轮重量 m (kg), 半径 R (mm) 及超重点 m (g) 的关系:

$$e_{per} = \frac{m \times R}{M} \text{ (g.mm / kg) 或 } (\mu\text{m})$$

e_{per} 也表示为残余不平衡量。

国际标准化组织 (ISO) 以下列公式:

$$e_{per} = \frac{1000 \times G}{\omega} = \frac{60 \times 1000 G}{2 \pi n} \approx \frac{9550 \times G}{n} \text{ (g.mm / kg) 或 } (\mu\text{m})$$

来表示最大残余不平衡量 e_{per} (g.mm/kg) 与平衡质量等级 G (mm/s) 及转速 n (r/min) 之间的关系(见表 2)。

例 1: SYT10-10L(DK) 风机的叶轮, 最高转速为 1800 r/min, 现要求平衡质量等级为 G2.5, 求它的允许残余不平衡量和校正平面上残余不平衡值。

(1) 求允许残余不平衡量:

$$e_{per} = \frac{9550 \times G}{n} = \frac{9550 \times 2.5}{1800} = 13.26 \mu\text{m}$$

SYT10-10L 叶轮质量为 3.231kg, 平衡轴质量为 4.446 kg, 合计为 7.677 kg。

$$\bar{U} = e \times M = 13.26 (\mu\text{m}) \times 7.677 (\text{kg}) = 101.8 \text{ g.mm}$$

(2) 求校正平面上残余不平衡值:

因为 SYT10-10L 为双进风离心风机, 需要校正左右两个平面的半径。

$$m = \frac{\bar{U}}{2r} = \frac{e \times M}{2r} = \frac{13.26 (\mu\text{m}) \times 7.677 (\text{kg})}{2 \times 141 (\text{mm})} = 0.361 \text{ g} = 361 \text{ mg}$$

This eccentricity e_{per} is expressed its relationship with the wheel of weight M (kg), radius R (mm) and over weight point m (g) by the formula below:

e_{per} is also called the residual unbalance.

The International Organization for Standardization (ISO) uses the following formula:

To express the relationship about the maximum residual unbalance e_{per} (g.mm/kg), the balance quality grades G (mm/s) and the rotation speed n (r/min). (Table 2)

E.g. 1: The fan SYT10-10L(DK) Wheel, and the fan's top speed is 1800 r/min. If it is required to balance to Balance quality Grade G2.5, find the permissible residual unbalance.

(1) The permissible residual unbalance:

The mass of SYT10-10L fan Wheel is 3.23kg; The mass of balance shaft is 4.446kg. Add up to 7.677kg.

(2) The residual unbalance of correcting plane:

Cause SYT10-10L is the double-inlet centrifugal fan, so it needs to check the radiuses of the right and left plane.

ISO 1940-1:2003(E)

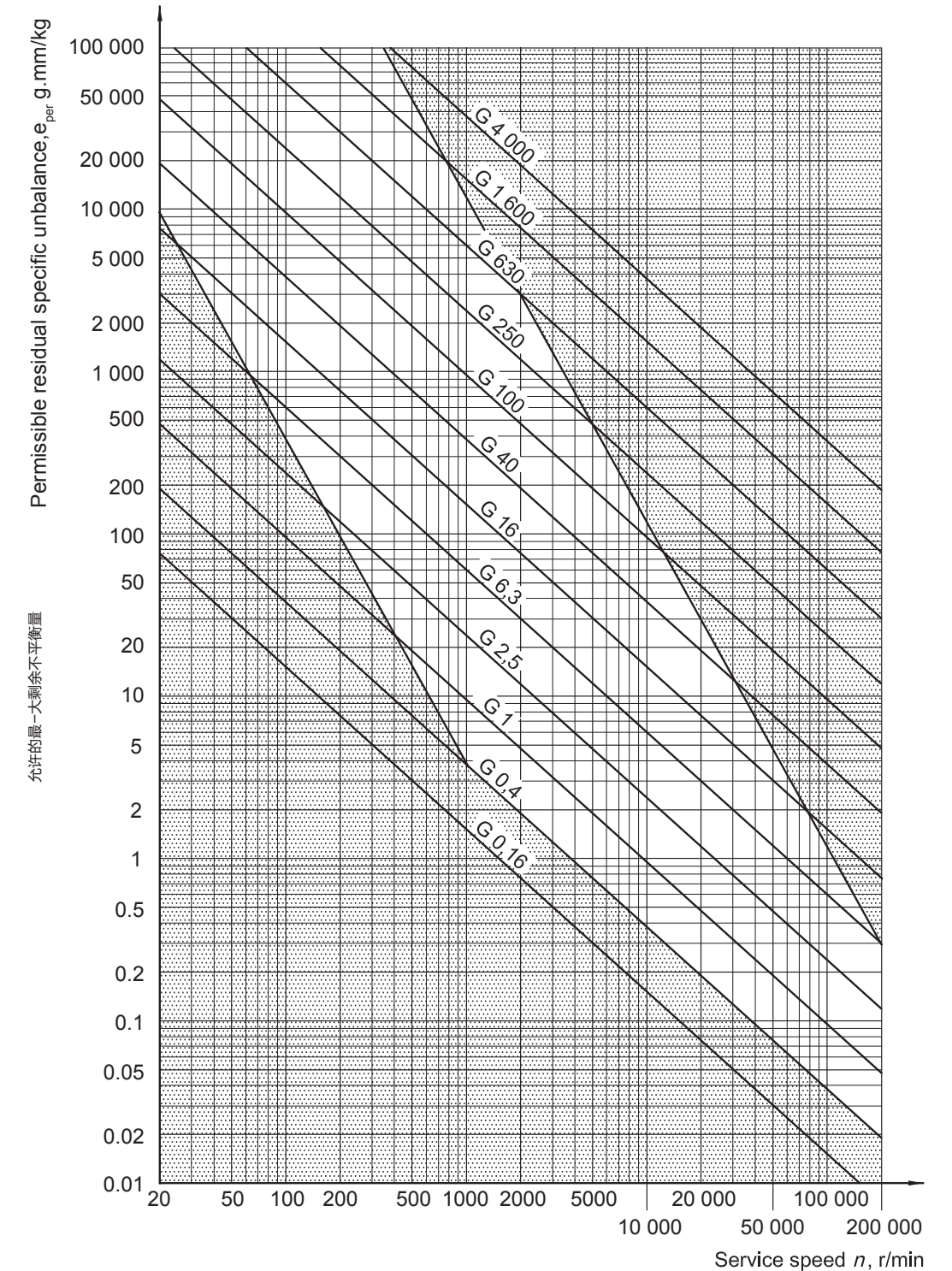

NOTE The white area is the generally used area, based on common experience.
Figure 2-Permissible residual specific unbalance based on balance quality grade G and service speed n (see 6.2)

亿利达风机的平衡

The Balancing of the Yilida Fans

亿利达为了保证风机的运行更稳定, 性能更好, 寿命更长久, 所以, 每一个风机都经过三道的平衡, 每一次的平衡都达到 ISO 平衡质量等级的 G2.5。

亿利达风机的三道平衡如下:

In order to ensure that all the fans are running with good performance and long lifetime, Yilida ensures that all its fans are going through 3 types of balancing, each type of balancing has reached the ISO Balance Quality Grades of G2.5. The three types of balance are as follows:

(a) 风机叶轮的平衡

亿利达生产的每一个叶轮都要做动、静平衡,使每个叶轮在组装前达到 G2.5 的平衡等级。

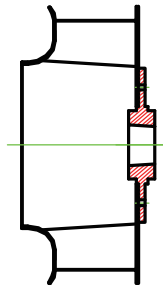

(a) Fan Wheel Balancing

Every wheel that manufactured by Yilida has to do the dynamic and static balance, so that each wheel is balanced to G2.5 before assembly.

(c) 整机的平衡

叶轮、进风口、进风口定位板、电机、底座及减振器等等组装成整机后,做最后的平衡,达到 G2.5 的平衡等级。平衡后的风机,电机等在运行时能更稳定。

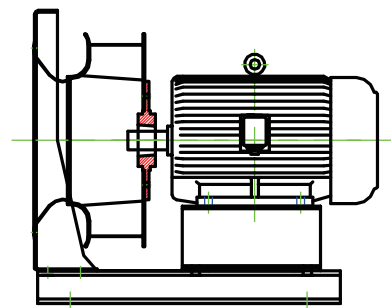

(c) Complete Fan Balancing

The wheel, inlet, inlet positioning plate, motor, base of frame, the vibration isolators are assembled together to have a complete fan. The complete fan has to go through the last balance to reach G2.5 balance grade. After balancing that the fan, motor etc will be running more stable.

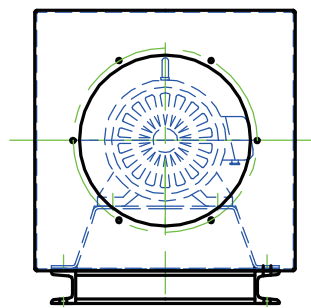

一、概述

声音的本质是波动。受作用的空气发生振动,当振动频率在20~20000Hz时,作用于人的耳鼓膜而产生的感觉称为声音。声源可以是固体、也可以是流体(液体和气体)的振动。下面介绍几个与声音相关的物理量。

1) 声功率级

任何一个声源在运转时都会向外辐射声能,在稳定工况下单位时间内辐射的声能称为声功率W,以瓦(W)为单位。通常声学上以声功率级表示,即

$$L_W = 10 \lg \frac{W}{W_0}$$

式中 L_W ——声功率级,单位为dB;
 W_0 ——基准声功率, $W_0=10^{-12}W$;
 W ——声功率,单位为W。

2) 声强级和声压级

声源的声功率无法直接测定,而使通过测定声源的声压或声强后计算出声功率。声压P或声强I同样以声压级 L_p 或声强级 L_I 表示,即

$$L_p = 20 \lg \frac{p}{p_0}$$

式中 L_p ——声压级,单位为dB;
 p ——声压,单位为Pa;
 p_0 ——基准声压, $p_0=2 \times 10^{-5}Pa$;该值是对1000Hz的声音人耳刚能听到的最低声级

$$L_I = 10 \lg \frac{I}{I_0}$$

式中 L_I ——声强级,单位为dB;
 I ——声强,单位为 W/m^2 ;
 I_0 ——基准声强, $I_0=10^{-12}W/m^2$ 。对于1000Hz的声音,人耳能感觉到的最小声强约为 $10^{-12} W/m^2$,该基本声强为人的听阈。对于正常人的听觉所能忍受的声强为 $I_{max}=1 W/m^2$,称为痛阈。

3) 倍频程与声音频谱特性

人类能听到的声音一般指频率为20~20000Hz范围内的声波。为了测量方便,往往将这个频率范围划分成若干小的频带或频段。在噪声测量中最常用的是倍频程和1/3倍频程。倍频程是指两个相邻频率之比为2:1确定的频段,国际IEC规格所规定的常用倍频程如表1所示。1/3倍频程就是将一个倍频程再划分为三段。

频谱为声压级或声功率级随着频率的变化的图形,通风机噪声可以粗略地分为三类:频谱中最高声压级的中心频率低于500Hz的为低频噪声,最高声压级的中心频率在500~1000Hz为中频噪声,最高声压级的中心频率大于1000Hz为高频噪声。通风机的频谱一般用频谱分析仪测量得到。

表 1

频程号 Octave number	1	2	3	4	5	6	7	8	
中心频率 center frequency/Hz	63	125	250	500	1000	2000	4000	8000	
频率范围 frequency coverage/Hz	45	90	180	355	710	1400	2800	5600	11200

Outlines

The sound is a travelling oscillation. The sound that the human can hear is within the frequency range from 20 Hz to 20,000 Hz. Sound source can be from the vibration of the solid or fluid (liquid and gas).

1) Sound Power Level

The sound power is the sound energy radiated constantly from a sound source. Sound power is expressed in watts (W). Sound power converted to the decibel scale is called sound power level (L_w).

where L_w ——sound power level, dB
 W_0 ——reference sound power, W
 W ——sound power, W

2) Sound Intensity Level and Sound Pressure Level

The sound power from the sound source cannot be directly measured. The sound power is calculated from the sound pressure or the sound intensity that measured from the sound source. Similarly, sound pressure level and sound intensity level are expressed as below:

where L_p ——sound pressure level, dB
 p ——sound pressure, Pa
 p_0 ——reference sound pressure, $p_0=2 \times 10^{-5} Pa$,

This value is the minimum sound level at 1,000 Hz that the human ear can hear.

where L_I ——sound intensity level, dB
 I ——sound intensity, W/m^2
 I_0 ——reference sound intensity.

This value is the minimum sound intensity that the human ear can feel, and is the human hearing threshold. The maximum sound intensity that the human ear can tolerate is $I_{max} = 1 W/m^2$, it is known as the pain threshold.

3) Octave Bands and Sound Spectrum Characteristics

Normally, human can hear sounds within frequency range from 20 Hz to 20,000 Hz. For the convenient measuring, this frequency range is divided into several small octave bands. The most commonly used in sound measurement is the octave bands and 1/3 octave bands. An octave band is the frequency interval between two sounds whose ratio is 2. Table 1 shown the octave bands from the IEC Standard. 1/3 octave band is an octave band that divided into three portions. Spectrum is the graphics that the sound pressure level or the sound power level changes with the frequency. The sound from a fan can be roughly divided into three categories:

- The maximum sound pressure level of the center frequency of the band below 500 Hz is called low-frequency noise.
- The maximum sound pressure level of the center frequency of the band within 500 Hz to 1,000 Hz is called medium frequency noise.
- The maximum sound pressure level of the center frequency of the band greater than 1,000 Hz is called high frequency noise.

二、声音的测试方法

声压级和声强级可以用声级计或声强仪进行测定。声级计是常用的测量仪器,声强仪的使用目前尚未普及。

除了以上三个衡量声音的基本参数之外,还需要了解声音的频率成分,这就需要声音进行频谱分析。常用的声音频谱为倍频程频谱和1/3倍频程频谱。声音频谱由精密声级计或专用的频率分析仪测定。通过声音频谱的测定,可以分析声源的频率成分,对其采取相应的降噪措施,使之减少向外辐射的声功率级。

声功率虽然可以由测定声压级的方法间接求得。但是,声压级测定时往往受到测试环境的影响而不易准确得出,为了使测试环境的影响降低至最小程度,创造了两种接近理想状态的实验室测试方法:自由声场法和混响声场法。

声源在一个特定空间内运行时,它所辐射的声能全部为边界所吸收而没有反射,在这个空间内形成特定的声波传播规律。这个特定空间称之为自由声场。模拟自由声场的实验室常用的是全消声室或半消声室。反之,若这个特定空间的边界是全反射而无声能的吸收,同样在此特定空间内也存在特定的声波传播规律。这个特定空间称之为混响声场,模拟混响声场的实验室常用的是混响室。

这里主要介绍下混响室法。

如果在以封闭的空室(混响室)内设置以声源,经过一段时间后,在该室内产生一恒定的声压级。

在切断声源后,声音并不立即消失,储存在空间的声能逐渐衰减,这一过程为扩散声场或混响声场。混响时间定义为声能密度衰减到60dB(即原有值的10⁻⁶倍)所需的时间。

在混响室中,测量充分扩散的声场,称为扩散声场法。若扩散声场的平均声压级为L_p,则相应的声功率级为

$$L_w = L_p + 10 \lg V - 10 \lg T - 14 \quad (\text{dB})$$

式中:V为混响室容积(m³);T为混响时间(s)。

如果测量充分扩散的声场,而混响室的房间常数为R,测量充分扩散的声场声压级为L_p,相应的声功率级为:

$$L_w = L_p + 10 \lg R - 6 \quad (\text{dB})$$

式中:R为混响室的房间常数

$$R = \frac{\alpha S}{1 - \alpha^2} \quad (\text{m}^2)$$

其中,α为吸声系数,一般α=0~1.0;S为混响室的表面积。

事实上,实验室的边界对所有频率不可能做到完全吸收或完全反射,这种差异性规定了在实验室测定声功率级的精度要求(对声压级来说即为允许偏差的要求),这就必须有一个统一的测试规定即测试方法的标准。这里有两种,一种是以国际标准化组织指定的标准(即ISO标准);另一种是美国AMCA或ASHRAE指定的标准属于行业性质的标准。两者的标准之间是存在一些区别的。

亿利达风机实验室所建的混响室与气动性能实验室结合在一起的风机测试实验室,属国内首创,符合AMCA300-96《风机声学测试——混响室法》的有关要求和规定。

Sound Testing Method

Sound pressure level and sound intensity level can be measured from the sound level measuring meter or the sound intensity meter. Besides the three basic parameters of the sound, it is important to understand the sound frequency which will have to analyze the sound spectrum. The sound spectrum can be measured from the sound frequency analyzer. From the analysis of the sound spectrum, the sound level can be reduced and the radiation of the sound power level can also be reduced.

The sound power can be determined indirectly from the measuring of the sound pressure level. However the sound pressure level is not easy to measure, as it is influenced by the effects of the testing environment. In order to minimize the impact of the testing environment, two ideal state of the laboratory testing methods are created, free field method and reverberant field method.

When sound source is running in a given space, all the sound energy radiated from the sound source is absorbed by the boundary without reflection, and form a specific propagation of the sound waves in this space. This particular space is called the free field. The laboratory that simulates the free field is normally used full-anechoic room or semi-anechoic room. Conversely, if the sound energy is totally reflected by the boundary of this particular space with no absorption, and it forms another specific propagation of the sound waves in this space. This particular space is called the reverberant field. The laboratory that simulates the reverberant sound field is normally used the reverberant room.

Below is the introduction of the reverberant room.

A sound source is set in a closed room (reverberant room), after a time, a constant sound pressure level is produced in the room. In this stable state, if ignored the loss of the sound power due to the absorption of the air and the wall surround, the sound power is equal to the sound power releases from the sound source. This process is the direct sound field. After switching off the sound source, the sound does not disappear immediately, The sound energy in the room is gradually attenuated, this process is the diffuse sound field or the reverberant sound field. The reverberation time is defined as the time required to let the sound energy density attenuate to 60 dB (i.e. 10 to 6 times the original value). In the reverberant room, measuring the full diffusion of the sound field is known as the diffuse sound field method. The sound power level is corresponding to the average sound pressure level L_p in the diffuse sound field as follow:

Where V ---- the volume of the reverberant room (m³)
T ---- the reverberation time (s).

If the reverberant room constant is R and the sound pressure level measured in the full diffusion of the sound field is L_p, then the corresponding sound power level is :

Where R ---- the reverberant room constant
And α ---- the absorption coefficient, normally α = 0 ~ 1.0
S ---- the surface area of the reverberant room.

In fact, all the sound frequencies can not be totally absorbed or reflected by the boundaries of the laboratory, this difference provides the accuracy requirement the sound power level measurement in the laboratory (it is the allowable deviation requirement of the sound pressure level). So, the test must have a unitary standard for the sound testing methods. There are two standards, one is the ISO standards, and the other is the AMCA or ASHRAE standards. There are some differences between the two standards.

Yilida's comprehensive fan performance test laboratory has a reverberant room and an aerodynamic performance lab. This reverberant room is built in according to the requirements and the regulations of AMCA 300-96 (Reverberant Room Method for Sound Testing of Fans).

三、声音的计算

如前所述,当声音信号进入A计权网络时,低频的声音按比例衰减通过,而1000Hz以上的声音无衰减地通过。这种被A网络计权后的声压级,就称为A声级L_A。它的单位为dB。A声级可以直接测量,也可以由8个倍频程声压级计算得到,其数学表达式为:

$$L_A = 10 \lg \sum_{i=1}^8 10^{0.1(L_{pi} + \Delta A_i)}$$

式中 L_{pi} ---- 倍频程声压级,单位为dB;

ΔA_i ---- 不同频率的计权衰减量,见表1,其中下标i=1,2,……,8分别代表8个倍频程中心频率63,125,250,500,1000,2000,4000,8000Hz。

中心频率 Center frequency/Hz	63	125	250	500	1000	2000	4000	8000
计权衰减量 Weighted attenuated value/Hz	-26	-16	-9	-3	0	1	1	-1

通风机的A声级不仅与风机尺寸大小与转速有关,而且还取决于流量和压力的大小。为了比较不同型号及不同性能参数的通风机的噪声特性,可以引入比A声级L_{SA},通风机测试工况点比A声级的数学表达式:

$$L_{SA} = L_A - 10 \lg (q_v p_{tF}^2) + 19.8$$

式中 L_{SA} ---- 通风机测试工况点的比A声级,单位为dB(A);

L_A ---- 通风机测试工况点的A声级,单位为dB(A);

q_v ---- 通风机测试工况点流量,单位为m³/min;

p_{tF} ---- 通风机测试工况点全压,单位为Pa。

目前国内指定的通风机噪声标准都采用比A声级来评价通风机的噪声特性。

在实际工作中进行声音叠加时,可查曲线值来计算。见图1。

两个噪声相加,L_{p,总}=L_{p1}+L_{p2},规律总结如下:

- 总声压级不会比其中任一个大3分贝以上;
- 两个声压级相差10分贝以上时,叠加增量可忽略不计。
- 两个声压级相差10分贝以下时,查表确定增加量,再与大的叠加。
- 对于多个声源,只需两两逐次叠加即可,和顺序没有关系。

图1 两噪声源的叠加曲线

Fig 1. Two noise sources superimposed curve

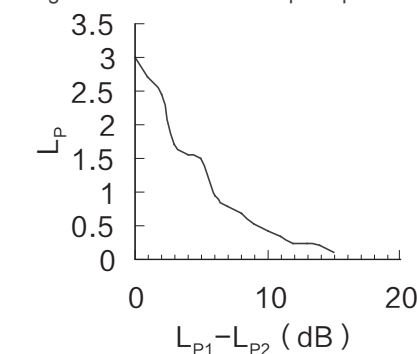

Sound Calculation

As mentioned earlier, when the sound signal enters the A weighting network, the low-frequency sound will attenuate proportionally through the network. The sound pressure level that was adjusted by A weighting network is called A-weighted sound level L_A, its unit is dB(A). The A-weighted sound level can be measured directly, can also be calculated from the 8 octave bands of the sound pressure level. Its expression is:

Where L_{pi} ---- octave band sound pressure level, in dB

ΔA_i ---- weighted attenuated value, refer to table 1, in which i=1,2,……,8 represent the 8 octave band centre frequency 63, 125, 250, 500, 1k, 2k, 4k, 8k Hz.

The A-weighted sound level of the fans is not only related with the fan size and the fan speed, but also depended on the air flow-rate and the pressure. In order to compare the sound characteristics of different models and different performance parameters, the specific A-weighted sound level L_{SA} is introduced. The specific A-weighted sound level is expressed as:

Where L_{SA} ---- the specific A-weighted sound level, in dB(A)

L_A ---- the A-weighted sound level, in dB(A)

q_v ---- the air flow-rate, in m³/min

p_{tF} ---- the total pressure in Pa.

At present, the fan noise standards are using the specific A-weighted sound level to evaluate the noise characteristics of the fans.

In actual work, when the sounds are combining, the curve shown in Figure 1 can be used to calculate the value of the combined sounds.

When two sounds are combined, L_{p, total} = L_{p1} + L_{p2}, the rules are as follow:

- The total sound pressure level is no more than any of the two sound pressure level by 3 dB.
- If the difference of the two sound pressure level is equal to, or more than 10 dB, the increment is negligible.
- When the difference of the two sound pressure level is less than 10 dB, then find the increment from the table, and add to the bigger sound pressure level.
- For more than two sound sources, just combine any two sound pressure level each time until the finished sound. pressure level is calculated, the sequence does not matter.

四、通风机噪声产生的原因

通风机的噪声主要包括空气动力所产生的噪声、机械振动所产生的噪声和两者共同作用产生的噪声 3 个方面。

1) 空气动力所产生的噪声

(a) 冲击噪声

叶轮高速旋转时，叶片作周期性运动，空气质点受到周期性力的作用，冲击压强波以声速传播所产生的噪声。

(b) 涡流噪声

叶轮高速旋转时，因气体边界分离而产生的涡流所引起的噪声

2) 机械振动性噪声

回转体的不平衡及轴承的磨损、破坏等原因所产生的振动必然会产生噪声，当叶片刚性不足，气流作用使叶片振动，也会产生噪声。

3) 两者相互作用而产生的噪声

叶片旋转引起自身振动通过管道传递，往往在管道弯曲部发生冲击和涡流，造成振动加剧使噪声增大，特别是当气流压强波的频率与管道自身振动相同时，将产生强烈的共振，噪声会突然增大，严重时会导致通风机破坏。

The Causes of the Noise Generated

There are three causes of the fan noise generated: aerodynamic, mechanical vibration, between the aerodynamic and the vibration.

1) The noise generated by aerodynamic

(a) The impact noise

When the Wheel is rotating at a high speed and the blade is moving periodically, the air particle is affected by the periodic force, that pushes the pressure waves at the sound speed to generate noise.

(b) Turbulence Noise

When the Wheel is rotating at a high speed, there may have a swirl occurred at the inlet of the fan, then a noise is generated due to turbulence.

2) The noise from the mechanical vibration

The unbalance Wheel, the damaged bearing and others will cause vibration. The vibration will generate noise. If the blade is not rigid enough, it will vibrate when rotating that will also generate noise.

3) The noise generated from the interaction between the aerodynamic and the vibration

Vibration caused by the rotating blades and transmitted through the duct, then occur impact and swirl in the bending of the duct that increase the vibration and increase the noise. Especially when the air pressure wave frequency is same as the vibration frequency of the duct that cause a strong resonance, then the noise suddenly increases. It can result in serious damage to the fan.

五、通风机噪声的控制

1) 设计良好的通风机

在设计时，为了防止或减少本身噪声源的产生，应尽量减少气流的冲击，避免尖锐突出和流道的急剧转弯。合理选择风机的转速大小，注意控制叶轮和蜗舌的间隙，此间隙越小，噪声越大。

2) 消声器

消声器一般可以通过吸收噪声源和进出口产生的噪声来隔音降噪。不同类型的风机用的消声器各有不同。

The Control of the Noise of the Fans

1) Well-designed of Fans

When design the fans, in order to prevent or reduce the generation of the sound source, should minimize the impact of the air flow, the side plate and the scroll must be smooth without uneven prominent, and avoid the sharp turn of the air flow. The fan speed must be selected correctly, and the gap between the cutoff and the wheel must be controlled, as the smaller the gap, the greater the noise.

2) Silencer

Silencer can generally absorb the sound source and the noise generated from the inlet and the outlet of the fans. Different types of fans will use different kind of silencers.

一、选择风机的原则

风机选型时，首先要确定系统所需的流量和压力。由于风机样本中流量和压力等性能参数通常都是以标准大气状态下给出的，所以须将使用条件(如输送气体的温度、密度、工作点海拔高度或大气压力等)下系统所需的流量、压力等参数换算到标准大气状态，依此选择风机。

通风机的标准大气状态，通常是指在海拔高度 0 m，温度 20℃，大气压力 101.325 kPa 时，输送相对湿度 50%，密度 1.2 kg/m³ 的空气。

The Principle of Fan Selection

First, we must determine the airflow and the pressure in the system. As the fan performance data in the catalog are usually given in the standard conditions, all the data of the operating point in the system must be converted to the standard atmospheric conditions before selection.

The standard atmospheric conditions are referred to altitude 0 m, temperature 20 °C, atmospheric pressure 101.325 kPa, air density 1.2 kg/m³.

二、温度和海拔高度对空气的影响

但是在实际选型过程当中，有些风机的应用场合分布在不同的海拔和温度环境下，此时气体的密度随之影响很大。

1) 海拔高度对大气压力的影响，可用以下公式表示：

$$p_1 = p_0 \times (0.885)^Z \div 1000$$

注：p₁——实际空气状态下压力；

p₀——标准状态下压力；

Z——海拔高度。

2) 而温度根据工况点的实际情况定，温度及大气压力对大气密度的影响，可由下列公式表示：

$$\rho_1 = \rho_0 \left(\frac{p_1}{p_0} \times \frac{273 + t_0}{273 + t_1} \right)$$

式中：ρ₀=1.2 kg/m³——标准大气状态的下的密度；

p₀=101.325 kPa——标准大气状态的大气压力；

t₀=20℃——标准大气状态的温度；

p₁、ρ₁、t₁——分别为实际空气状态下的压力、密度和温度。

3) 设：

$$e = \frac{p_1}{p_0} \times \frac{273 + t_0}{273 + t_1}$$

可得：

e——大气密度的修正系数。

$$e = \frac{\rho_1}{\rho_0}$$

可得：

$$\therefore p_1 = p_0 \times (0.885)^Z \div 1000 \quad \therefore \frac{p_1}{p_0} = (0.885)^Z \div 1000$$

$$e = \frac{(0.885)^Z}{1000} \times \frac{273 + t_0}{273 + t_1}$$

通过上式可得下表：

The Effects of Temperature and Altitude

Some fans are used in a high altitude and different temperature conditions, where the air density will vary accordingly. The effects of the temperature and the altitude must be considered, when doing selection.

1) The effect of the altitude to the atmospheric pressure can be expressed as the following formula:

Note: p₁—— actual atmospheric pressure,

p₀—— standard atmospheric pressure,

Z—— altitude.

2) The effects of the temperature and the atmospheric pressure to the air density can be expressed as the following formula:

where:

ρ₀=1.2kg/m³—— air density in the standard atmospheric condition,

p₀=101.325kPa—— standard atmospheric pressure,

t₀=20℃—— temperature in the standard atmospheric condition,

p₁, ρ₁, t₁——actual atmospheric pressure, air density and temperature.

3) If

then:

e—— the correction factor of air density.

then:

From the above, the following table can be calculated:

大气密度的修正系数表
Atmospheric density correction factor table

气温℃ Air Temperature	海拔 Altitude (单位:m)															
	0	400	800	1200	1600	2000	2400	2800	3200	3600	4000	4400	4800	5200	5600	6000
-40	1.26	1.20	1.14	1.09	1.04	0.99	0.94	0.89	0.85	0.81	0.76	0.73	0.69	0.65	0.62	0.59
-20	1.16	1.11	1.05	1.00	0.96	0.91	0.87	0.82	0.78	0.74	0.70	0.67	0.64	0.60	0.57	0.54
0	1.07	1.03	0.98	0.93	0.89	0.84	0.80	0.76	0.73	0.69	0.65	0.62	0.59	0.56	0.53	0.50
20	1.00	0.96	0.91	0.87	0.83	0.78	0.75	0.71	0.68	0.64	0.61	0.58	0.55	0.52	0.49	0.47
40	0.94	0.89	0.85	0.81	0.77	0.73	0.70	0.67	0.63	0.60	0.57	0.54	0.51	0.49	0.46	0.44
60	0.88	0.84	0.80	0.76	0.73	0.69	0.66	0.63	0.59	0.56	0.54	0.51	0.48	0.46	0.43	0.41
80	0.83	0.79	0.76	0.72	0.69	0.65	0.62	0.59	0.56	0.53	0.51	0.48	0.46	0.43	0.41	0.39
100	0.79	0.75	0.71	0.68	0.65	0.62	0.59	0.56	0.53	0.50	0.48	0.45	0.43	0.41	0.39	0.37
140	0.71	0.68	0.65	0.62	0.59	0.56	0.53	0.50	0.48	0.46	0.43	0.41	0.39	0.37	0.35	0.33
180	0.65	0.62	0.59	0.56	0.53	0.51	0.48	0.46	0.44	0.42	0.39	0.37	0.35	0.34	0.32	0.30
220	0.59	0.57	0.54	0.52	0.49	0.47	0.44	0.42	0.40	0.38	0.36	0.34	0.33	0.31	0.29	0.28
260	0.55	0.53	0.50	0.48	0.45	0.43	0.41	0.39	0.37	0.35	0.33	0.32	0.30	0.29	0.27	0.26
300	0.51	0.49	0.47	0.44	0.42	0.40	0.38	0.36	0.35	0.33	0.31	0.30	0.28	0.27	0.25	0.24
350	0.47	0.45	0.43	0.41	0.39	0.37	0.35	0.33	0.32	0.30	0.29	0.27	0.26	0.24	0.23	0.22
400	0.44	0.42	0.40	0.38	0.36	0.34	0.33	0.31	0.29	0.28	0.27	0.25	0.24	0.23	0.21	0.20
450	0.41	0.39	0.37	0.35	0.33	0.32	0.30	0.29	0.27	0.26	0.25	0.23	0.22	0.21	0.20	0.19
500	0.38	0.36	0.35	0.33	0.31	0.30	0.28	0.27	0.26	0.24	0.23	0.22	0.21	0.20	0.19	0.18

注：当实际温度或海拔高度不在表中时，可进行数据的插值计算
Note: When the actual temperature or altitude is not on the table, the data can be interspersed calculation

例 1：某化工行业项目在海拔 0 米，平均气温 10℃的环境需要一台双进风后向离心风机来送风，客户要求的是质量流量为 12000 kg/h，静压为 500 Pa。

解：当具体风机选型时，需考虑两方面因素，一方面是所给流量参数是质量流量（单位是 kg/h）还是体积流量（单位是 m³/h）；如果给的是体积流量那就按实际值计算。如果给的是质量流量，那要转化成体积流量。一般情况下默认是体积流量。
第二方面考虑的内容压力 P。当一定的风机尺寸和一定转速，密度发生变化时，所有压力变化与密度成正比，功率和密度也是成正比的。

通过查表可得海拔 0 米，气温 10℃时密度系数 e 为 1.07。
转化到标准大气状态下：

$$q_{V1} = \frac{q_{m1}}{\rho_1} \quad \rho_1 = \rho_0 \times e \quad \therefore q_{V1} = \frac{q_{m1}}{\rho_0 \times e} = \frac{12000 \text{ kg/h}}{1.2 \text{ kg/m}^3 \times 1.07} = 9346 \text{ m}^3/\text{h}$$

因为在一定的风机尺寸和一定的转速，密度变化时：流量不受影响。

$$\therefore q_{V0} = q_{V1} = 9346 \text{ m}^3/\text{h}$$

$$\frac{p_1}{p_0} = \frac{\rho_1}{\rho_0} = e \quad \therefore p_0 = p_1 \div e = 500 \text{ Pa} \div 1.07 = 467 \text{ Pa}$$

选型可得风机型号为 SYD450K，风机转速 735 r/min，风机轴功率为 1.824 kW，电机功率为 2.2 kW。

表 1
Fig 1

E.g. 1: A chemical factory which is located at an altitude 0 m and average temperature 10℃ place needs a DIDW centrifugal fan to supply air. The required mass flow rate is 12000 kg/h and the static pressure is 500 Pa.

Before selection, the following must be considered:
First, if the flow rate given is mass flow rate, then convert the mass flow rate to the volume flow rate.
Second, when there is a difference in the air density, the pressure p must be converted to the pressure in the standard atmospheric condition.

From the table, at altitude 0 m and temperature 10℃, the corrective factor of the air density e is 1.07.
Convert to standard atmospheric condition:

Because the volume flow rate is unchanged when the air density is changing, but the fan diameter and rpm are not changing.

From the above data, the fan selected is SYD 450 K, fan speed is 735 r/min, shaft power is 1.824 kW and the motor power is 2.2 kW.

此前一直正常运行，随着进入夏季，该厂在实际生产中发现风机性能达不到要求，于是找到生产厂家寻求解决办法。

解：通过询问该厂的环境情况得知，目前该厂最高温度在 40℃；通过查表可得海拔 0 米，气温 40℃时密度系数 e 为 0.94。
转化到标准大气状态下：

$$q_{V1} = \frac{q_{m1}}{\rho_1} \quad \therefore q_{V1} = \frac{q_{m1}}{\rho_0 \times e} = \frac{12000 \text{ kg/h}}{1.2 \text{ kg/m}^3 \times 0.94} = 10638 \text{ m}^3/\text{h}$$

同理可得：

$$q_{V0} = q_{V1} = 10638 \text{ m}^3/\text{h}$$

$$\frac{p_1}{p_0} = \frac{\rho_1}{\rho_0} = e \quad \therefore p_0 = p_1 \div e = 500 \text{ Pa} \div 0.94 = 532 \text{ Pa}$$

选型可得风机型号为 SYD450K，风机转速 775 r/min，风机轴功率为 2.323 kW，电机功率为 3 kW。针对这种温度变化，使用者对风量要求比较严格的情况：建议使用 3 KW 的变频电机，变频调节风机转速或者配 3 KW 的普通电机再配上风量调节阀来控制。

例 1：某工程项目在海拔 800 米，气温 60℃的环境需要一台单进风后向离心风机来送风，风量为 20000m³/h，静压为 900Pa。请选型。

解：通过查表可得海拔 800 米，气温 60℃时密度系数 e 为 0.80。
转化到标准大气状态下：

$$\frac{p_1}{p_0} = \frac{\rho_1}{\rho_0} = e \quad \therefore p_0 = p_1 \div e = 900 \text{ Pa} \div 0.80 = 1125 \text{ Pa}$$

压力按 1125 Pa 选型可得风机型号为 SYQS900E，风机转速 933 r/min，风机轴功率为 8.124 kW，电机功率为 11 kW。可后来根据实际需要又将设备移到海拔 3000 m 的环境下使用，发现此时静压不够，求解决问题的方法。

解：通过查表可得海拔 3200 米，气温 60℃时密度系数 e 为 0.59。
转化到标准大气状态下：

$$\frac{p_1}{p_0} = \frac{\rho_1}{\rho_0} = e \quad \therefore p_0 = p_1 \div e = 900 \text{ Pa} \div 0.59 = 1525 \text{ Pa}$$

压力按 1525 Pa 选型可得风机型号为 SYQS900E，风机转速 1061 r/min，风机轴功率为 11.35 kW，电机功率为 15 kW。此时需要更换电机和皮带轮才能满足工况需求。

In summer, the client find that the air flow does not meet the requirement, so he calls for help.

Knowing that the temperature now is 40℃, from the table, at altitude 0 m and temperature 40℃, the corrective factor of the air density e is 0.94.
Convert to standard atmospheric condition:

Similarly:

$$q_{V0} = q_{V1} = 10638 \text{ m}^3/\text{h}$$

From the data above, the fan selected is SYD 450 K, fan speed is 775 r/min, brake horsepower is 2.323 kW and the motor power is 3 kW. For this project, the air mass flow rate must be constant, so it is recommended to use 3 kW motor. By using the VFD to change the motor speed or using damper to control the air volume, to ensure that the air mass flow rate is constant.

E.g. 2: A project which is located at altitude 800 m and average temperature 60℃ place requires a single inlet backward inclined centrifugal fan to supply air. The air volume is 20000 m³/h and the static pressure is 900 Pa.

From the table, at altitude 800 m and temperature 60℃, the corrective factor of the air density e is 0.80.
Convert to standard atmospheric condition:

From the above data, the fan selected is SYQS 900 E, fan speed is 933 r/min, brake horsepower is 8.124 kW and the motor power is 11 kW. After some times, the fan is moved to a location at altitude 3200 m and temperature 60℃, then find that the static pressure is not enough for the operating. Find the solution.

From the table, at altitude 3200 m and temperature 60℃, the corrective factor of the air density e is 0.59.
Convert to standard atmospheric condition:

From the above data, the fan selected is SYQS 900 E, fan speed is 1061 r/min, brake horsepower is 11.35 kW and the motor power is 15 kW.
So, to solve the problem, the motor and the drive package must be changed to satisfy the requirement.

SYWA 系列离心式空调风机

Centrifugal Ventilators

概述

Summary

浙江亿利达风机股份有限公司特此证明，此处所示 SYWA 系列离心风机获得了加盖 AMCA 印章的授权。所示额定值系根据 AMCA 出版物 211 和 AMCA 出版物 311 所进行测试和程序确定，并符合 AMCA 认证额定值计划的要求。

这里描述的所有离心风机都已经取得了 AMCA 印章，其认证数据见第 031 页到 045 页。

Zhejiang Yilida Ventilator Co.,Ltd. certifies that the SYWA Series fans shown herein are licensed to bear the AMCA Seal. The ratings shown are based on tests and procedures performed in accordance with AMCA Publication 211 and AMCA Publication 311 and comply with the requirements of the AMCA Certified Ratings Program.

All the Centrifugal Fans described herein are licensed to bear the AMCA Seal, and their certified ratings are shown on pages 031 through 045.



SYWA 系列离心式空调风机采用国际同类产品先进技术自行开发生产，通过了 AMCA 国际认证并取得 AMCA 印章。该样本中列出的 13 种规格风机，流量范围从 500m³/h-70000m³/h。具有结构紧凑、效率高、噪声低等特点，是各类中央空调机组及其他暖通空调、净化、通风等设备理想的配套产品。

The SYWA Series of the centrifugal plug fans were developed with advanced technologies. They are licensed to bear the AMCA Seal for air performance, sound, and FEG. The SYWA Series includes 13 models as described in this catalogue. The volume flow of the SYWA Series ranges from 500 m³/h to 70,000 m³/h. Some of the features and characteristics of these fans are: compact structure, high efficiency, low noise, and low power consumption. These fans are ideal for use in central air-conditioning systems, in purifiers. They are also suitable for use in a variety of other ventilation applications.

命名方式

Nomenclature

SYW A 280

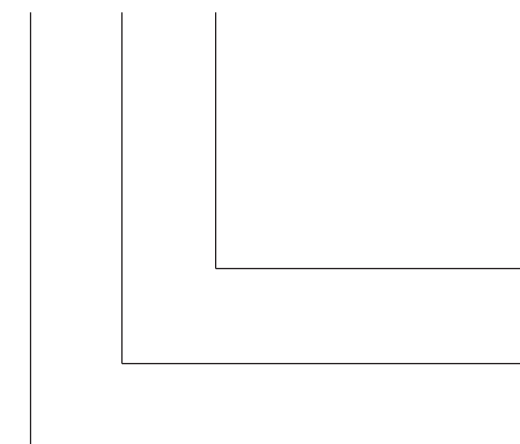

叶轮名义直径 (mm)

Nominal diameter of wheel (mm)

机翼型

Airfoil

后向无蜗壳离心风机系列代号

Fan series with plug backward blades

产品结构

Product Features

SYWA 系列风机主要由叶轮、进风口、进风口定位板、电机支架构成。风机底座为可选件。风机底座(常规配置不带法兰)构成。

SYWA series fans are mainly constructed of Wheel, inlet, inlet positioning plate and motor bracket. Fan base (is optional).

1. 叶轮

1. wheel

无蜗壳风机叶轮采用优质钢板加工制作，采用符合空气动力学的机翼型叶片保证了高效率，低功耗的特点。该离心风机采用回转无叶扩压技术，特性曲线光滑，静压效率高。所有叶轮均按照 ANSI/AMCA204-05 标准运用精确的电子平衡机进行静平衡和动平衡测试，内控精度达到 G2.5 级或更优水平。

Plug backward airved blade Wheel is constructed of high-grade steel With the advanced aerodynamics profile to achieve higher efficiency and lower noise level. With the non Wheel diffuser technology, the centrifugal fan can get a smooth performance curve and make the static efficiency increase clearly. All Wheels are balanced to ANSI/AMCA Standard 204-05. Yilida's internal standard is G2.5 or higher for wheel balancing.

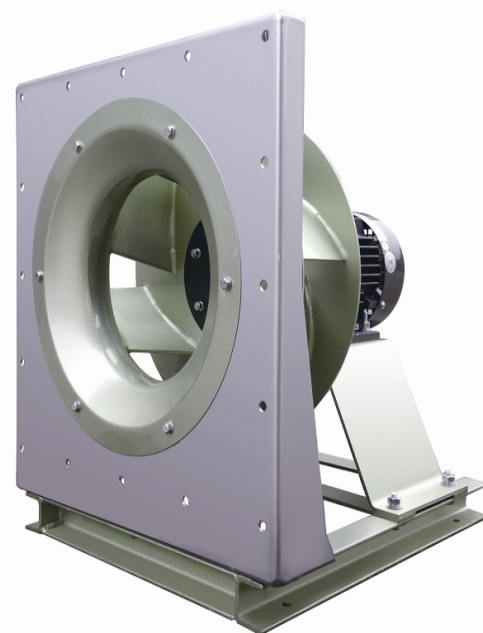

2. 进风口

无蜗壳风机进风口采用优质钢板或铝合金加工制作，符合空气动力学的流线型设计，整体拉伸工艺成型。与叶轮配合部分采用二次翻边工艺，使得气流更加稳定的进入叶轮，减少了压力损失并提高了风机效率。

叶轮与进风口配合：无蜗壳风机的进风口与叶轮配合部分的轴向及径向距离是按照空气动力学设计计算，能够提高风机性能稳定性。

3. 进风口定位板

进风口面板采用高强度钢板加工制作而成，面板四边采用翻边焊接工艺并采用加强板与底座连接，增加了面板的强度，使得风机在运行的时候面板能够承受更大的压力并能降低风机的振动。对于叶轮直径较大、压力较大的风机安装风机加强支架，能够提高风机运行的稳定性以及安全性。

4. 风机底座

风机底座采用槽钢型材经焊接加工成型，强度高，安装方便。

5. 电机支架

电机支架结构充分考虑了气流的流道设计，能够减小风机的流动损失。采用钢板折弯成型，对于受力较大部分有加强板进行加强，有效提高风机运行的安全性。

轮毂：轮毂采用锥套式或顶丝轴套式结构，保证了叶轮与电机连接的稳定性，提高风机的运行安全性。

6. 电机

亿利达风机标配使用全封闭三相鼠笼式电机，符合 IEC 和 EN 标准。标准电机的绝缘等级为 F 级，防护等级为 IP54 以上，B 级温升。使用环境温度为 $-40^{\circ}\text{C} \sim +40^{\circ}\text{C}$ ，其它的运行条件见要求。电机轴承寿命为 $L_{10} \geq 100000$ 小时。

2. Inlet

Plug backward curved inlet is constructed of high-grade steel or aluminum alloy with the whole stretch forming process by the advanced aerodynamics profile design. The inlet, where is fixed to the Wheel use two flanging process to make the air into the Wheel more stable, losses lesser and fan efficiency higher.

Wheel fits inlet: the axial and radial distance where in the inlet fits the is designed by the aerodynamic calculation to improve the fan performance stability. The sizes in detail are shown on page

3. Inlet Panel

Inlet panel is constructed of high-strength steel by flanging and welding in four sides, fitted to the base by the strengthened board to increase the strength of the panel, making the panel withstand greater pressure when the fan runs to reduce fan vibration. For larger diameter Wheel, greater pressure, the fan can improve the fan operation stability and safety by increasing the strengthen of the fan. bracket.

4. Fan Base

Fan base is high strength and easy to install by using channel steel with welding molding.

5. Motor Bracket

To reduce the fan flow losses, the motor bracket structure takes the air flow into account fully. It can strengthen the greater pressure area by the strengthening board to improve fan running safety.

Hub: hub is constructed of tapered sleeve or threaded shaft sleeve to ensure the stability of the Wheel fitting the motor, and to improve the fan running safety.

6. Motor

The motor used in SYWA series fans are totally-enclosed three-phase squirrel-cage motors, they are up to the standards of the IEC and the EN, Standard motors' Insulation Class is F, and Ingress Protection is IP54 or above, B temperature rise. Ambient temperature is $-40^{\circ}\text{C} \sim +40^{\circ}\text{C}$, the other operating conditions are shown in the requirements. Motor bearing service life (L_{10}) are over 100,000 hours ($L_{10} \geq 10000$ hours).

风机性能

Performance Chart

1、风机选型示意图例

1. Example of Cruve Reading

型号 Type	SYWA710
风量 Volume	$q_v=16553\text{m}^3/\text{h}$
静压 Static Pressure	$P_{st}=1030\text{Pa}$
动压 Dynamic Pressure	$P_{ef}=61\text{Pa}$
风机转速 Fan Speed	$n=1450\text{r}/\text{min}$
轴功率 Shaft Power	$P_{sh}=6.571\text{KW}$
A声功率级 A Sound Power Level	$L_{WA}=96.8\text{dB(A)}$
静压效率 Static Efficiency	$\eta_{st}=72\%$

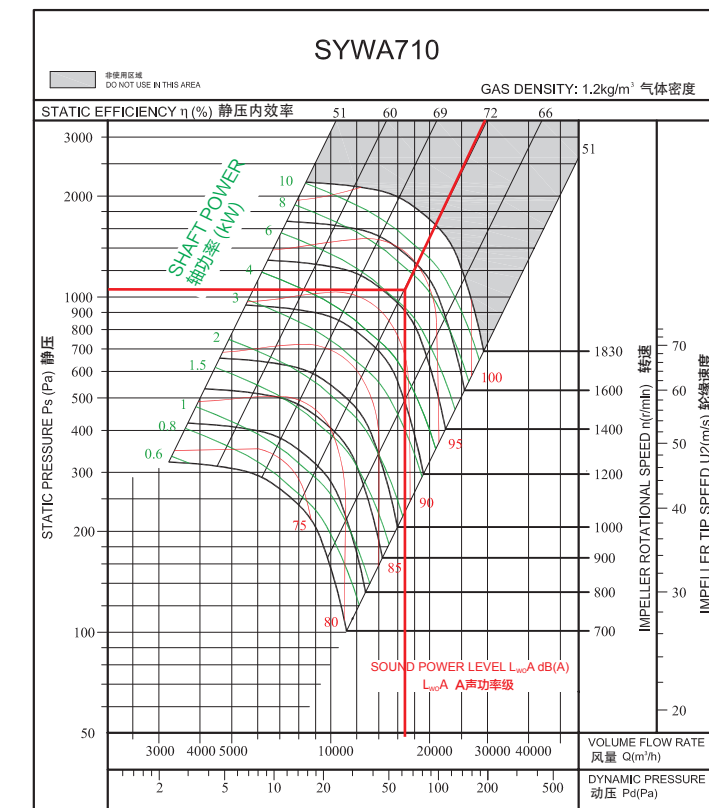

说明

- 1). 订货时须注明风机型号、转速、风量、风压、出风口方向和旋转方向。若需配套皮带、皮带轮、电机、安装底座等配件及其它特殊要求可在订货时提出。
- 2). 在安装前应对风机各部件进行检查，对叶轮、主轴和轴承等主要机件应重点细致检查，如有损伤应修复后再安装使用。
- 3). 检查机壳和其它壳体内部，不应有掉入、遗留的工具和杂物。
- 4). 风机正式运转前，需检查电机的转向是否符合风机转向的要求。
- 5). 风管与出风口之间应采用软连接，接头不得拉紧。
- 6). 风机安装后用手或杠杆拨动叶轮，检查是否过紧或碰撞现象，确认无这些现象时方可进行试转。
- 7). 风机配用电机功率是指在特定工况下，风机内功率加上机械损失与电机容量安全系数而言，并非出风口全敞开时所需的功率。为防止电机超功率运行而烧毁，严禁风机出风口或进风口不接管路或未加外界任何阻力进行空运转。
- 8). 风机在无较大腐蚀性气体、不含酸（碱）性和尘粒物质小于 $150\text{mg}/\text{m}^3$ 的气体、 $-20^\circ\text{C} < \text{温度} < 85^\circ\text{C}$ 的气体环境下使用，风机在运输装卸过程中应小心轻放，防止碰撞挤压。

Instructions

- 1) When placing the order, it is necessary to state the type of fan, speed, air volume, air pressure, discharge direction, rotation direction, type of electric motor and its specifications.
- 2) Prior to installation, the fan should be carefully inspected. Special care should be taken in checking the shaft, Wheel and bearings. If there is an indication of any damage, the damaged parts should be repaired or replaced before the fan is installed or commissioned.
- 3) The inside of the scroll and casing need to be checked to make sure that there are no foreign objects inside the housing, such as tools or loose parts.
- 4) The rotational directions of the motor and Wheel should be checked to ensure that they are in compliance with the specification and purchase orders.
- 5) A flexible connector should be used between the fan out let flange and its mating ductwork. The flex connector should not be over-stretched.
- 6) Following the installation, the Wheel should be turned by hand or with the use of a wrench to make sure that it turns freely without colliding with other parts of the fan. Once all this is done, the fan can be commissioned normally.
- 7) The rated motor power as calculated herein might not be sufficient to drive the fan with an unrestricted discharge flow. Operating the fan with an unrestricted discharge outlet will result in flow rate that exceeds the specified fan capabilities. Such operation will quickly burn the motor and damage the fan. Great care must be taken in operating the fan to make sure that the maximum rated flows, as provided on the performance charts in this catalog, are not exceeded.
- 8) The fan is limited for use in areas where air substances are non-corrosive, non-toxic and non-erosive and where dust particles are less than $150\text{mg}/\text{m}^3$ with a temperature between -20°C and 85°C . Special care should be taken during transportation, load and unload.

技术参数

Wheel diameter	叶轮直径	D = 289 mm	Fan weight	风机重量	m = 30 kg
Moment of inertia	转动惯量	J = 0.056 $\text{kg}\cdot\text{m}^2$	Speed limit	极限转速	$n_{\text{max}} = 4840 \text{ r/min}$

Technical Data

性能曲线

经认证的性能是A类安装：自由入口，自由出口。各项性能额定值不包括附属物(附件)的影响。所示A加权声音性能额定值已按AMCA International标准301计算。所示值为安装类型A：自由入口，自由出口的声功率级（出口 L_{wA} ）。

Performance Curves

Performance certified is for installation type A: free inlet, free outlet. Performance ratings do not include the effects of appurtenances (accessories). The A-weighted sound ratings shown have been calculated per AMCA International Standard 301. Values shown are for outlet L_{wA} sound power levels for installation type A: free inlet, free outlet.

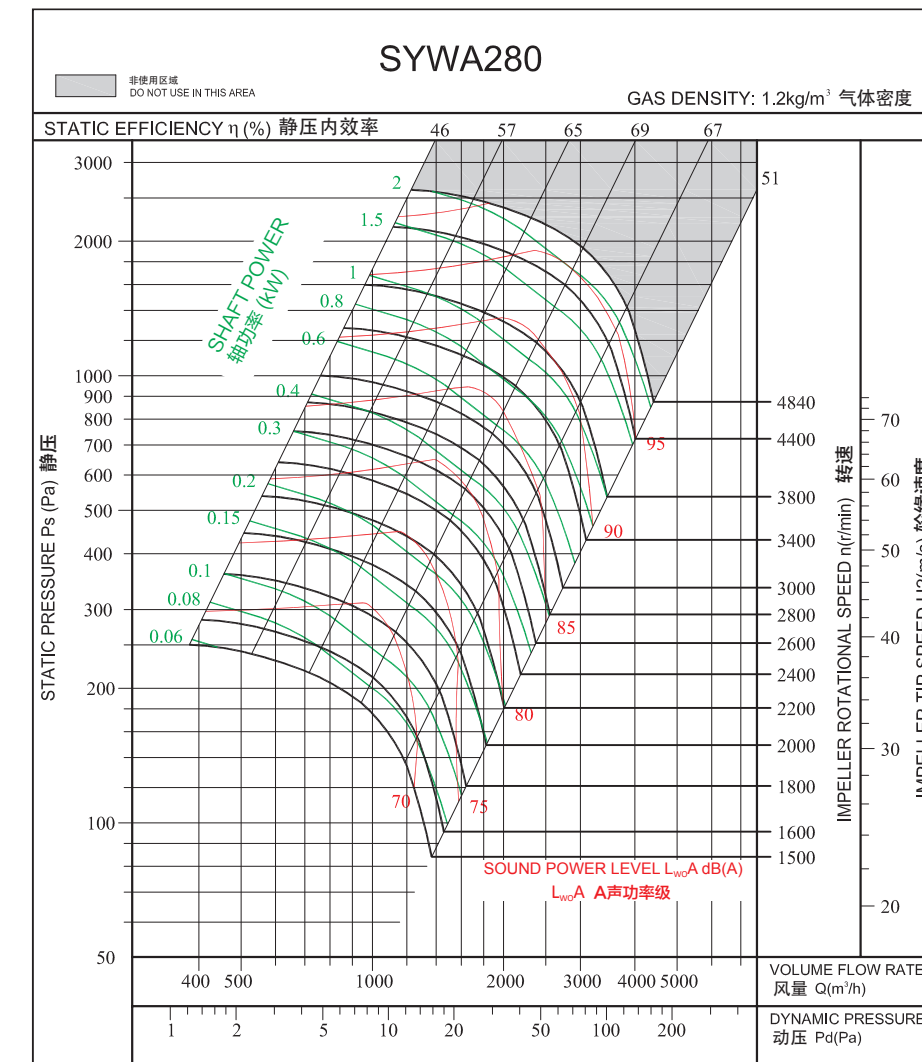

Measured in installation A according to AMCA Standard 210:

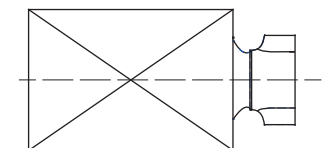

技术参数

Technical Data

Wheel diameter 叶轮直径	D = 325 mm	Fan weight 风机重量	m = 40 kg
Moment of inertia 转动惯量	J = 0.076 kg·m ²	Speed limit 极限转速	n _{max} = 4140 r/min

技术参数

Technical Data

Wheel diameter 叶轮直径	D = 383 mm	Fan weight 风机重量	m = 45 kg
Moment of inertia 转动惯量	J = 0.136 kg·m ²	Speed limit 极限转速	n _{max} = 3720 r/min

性能曲线

Performance Curves

经认证的性能是A类安装：自由入口，自由出口。各项性能额定值不包括附属物(附件)的影响。所示A加权声音性能额定值已按AMCA International标准301计算。所示值为安装类型A：自由入口，自由出口的声功率级（出口L_{wcA}）。

Performance certified is for installation type A: free inlet, free outlet. Performance ratings do not include the effects of appurtenances (accessories). The A-weighted sound ratings shown have been calculated per AMCA International Standard 301. Values shown are for outlet L_{wcA} sound power levels for installation type A: free inlet, free outlet.

性能曲线

Performance Curves

经认证的性能是A类安装：自由入口，自由出口。各项性能额定值不包括附属物(附件)的影响。所示A加权声音性能额定值已按AMCA International标准301计算。所示值为安装类型A：自由入口，自由出口的声功率级（出口L_{wcA}）。

Performance certified is for installation type A: free inlet, free outlet. Performance ratings do not include the effects of appurtenances (accessories). The A-weighted sound ratings shown have been calculated per AMCA International Standard 301. Values shown are for outlet L_{wcA} sound power levels for installation type A: free inlet, free outlet.

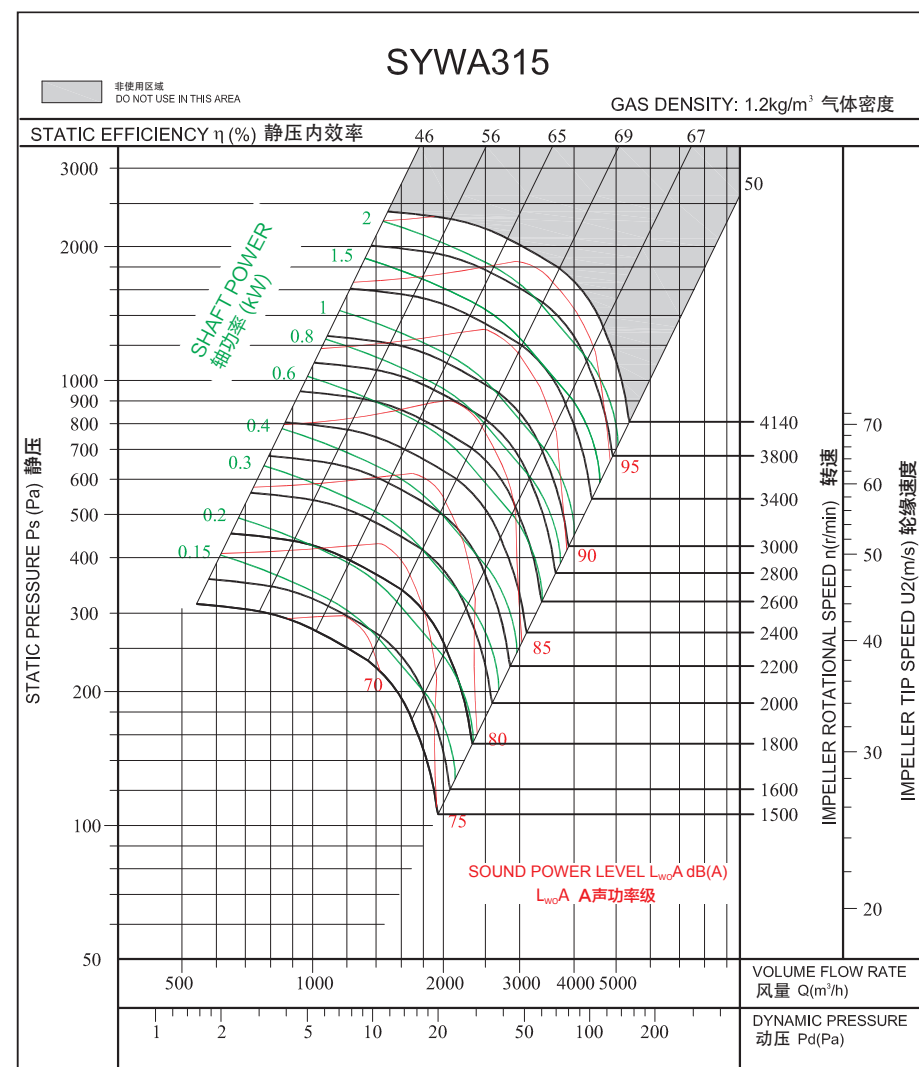

Measured in installation A according to AMCA Standard 210:

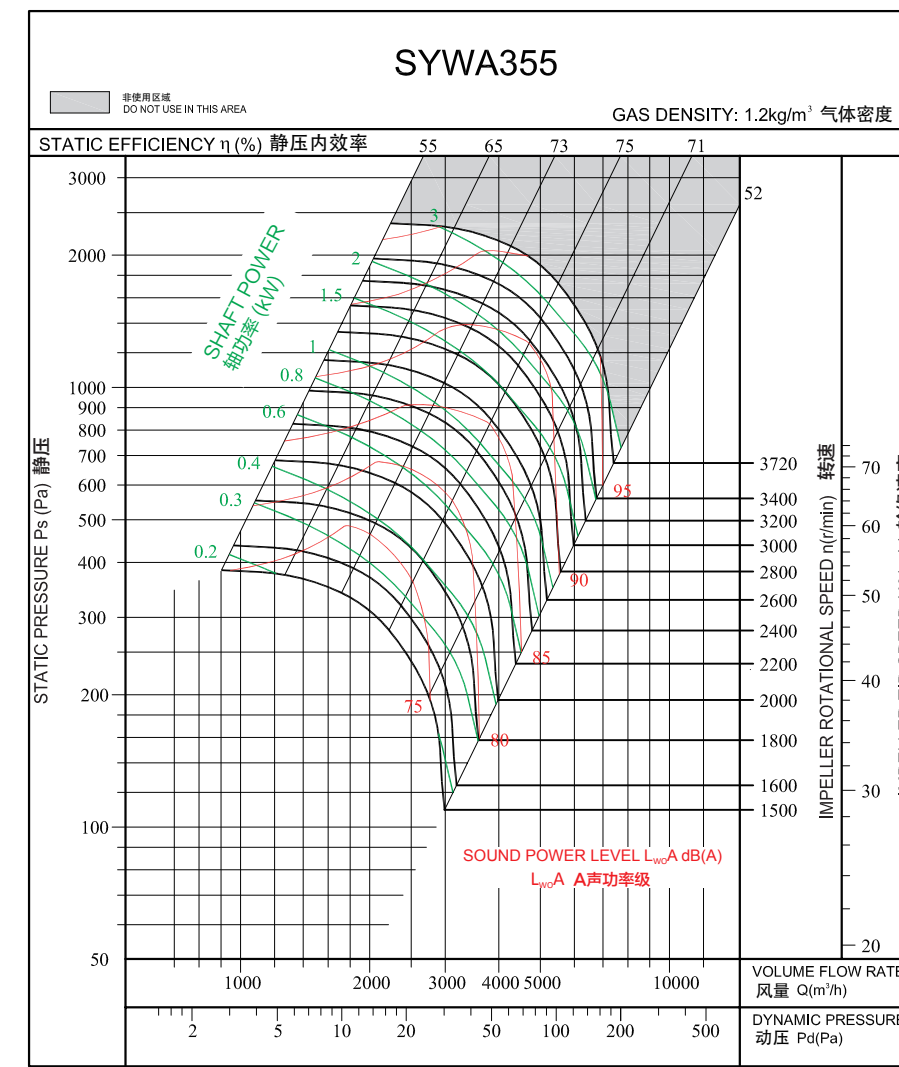
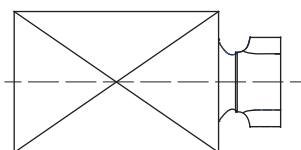

Measured in installation A according to AMCA Standard 210:

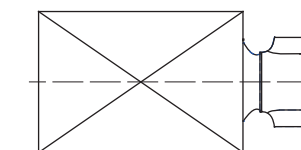

技术参数

Technical Data

Wheel diameter	叶轮直径	D = 408 mm	Fan weight	风机重量	m = 55 kg
Moment of inertia	转动惯量	J = 0.208 kg·m ²	Speed limit	极限转速	n _{max} = 3300 r/min

技术参数

Technical Data

Wheel diameter	叶轮直径	D = 458mm	Fan weight	风机重量	m = 65 kg
Moment of inertia	转动惯量	J = 0.393 kg·m ²	Speed limit	极限转速	n _{max} = 3000 r/min

性能曲线

Performance Curves

经认证的性能是A类安装：自由入口，自由出口。各项性能额定值不包括附属物(附件)的影响。所示A加权声音性能额定值已按AMCA International标准301计算。所示值为安装类型A：自由入口，自由出口的声功率级（出口L_{wcA}）。

Performance certified is for installation type A: free inlet, free outlet. Performance ratings do not include the effects of appurtenances (accessories). The A-weighted sound ratings shown have been calculated per AMCA International Standard 301. Values shown are for outlet L_{wcA} sound power levels for installation type A: free inlet, free outlet.

性能曲线

Performance Curves

经认证的性能是A类安装：自由入口，自由出口。各项性能额定值不包括附属物(附件)的影响。所示A加权声音性能额定值已按AMCA International标准301计算。所示值为安装类型A：自由入口，自由出口的声功率级（出口L_{wcA}）。

Performance certified is for installation type A: free inlet, free outlet. Performance ratings do not include the effects of appurtenances (accessories). The A-weighted sound ratings shown have been calculated per AMCA International Standard 301. Values shown are for outlet L_{wcA} sound power levels for installation type A: free inlet, free outlet.

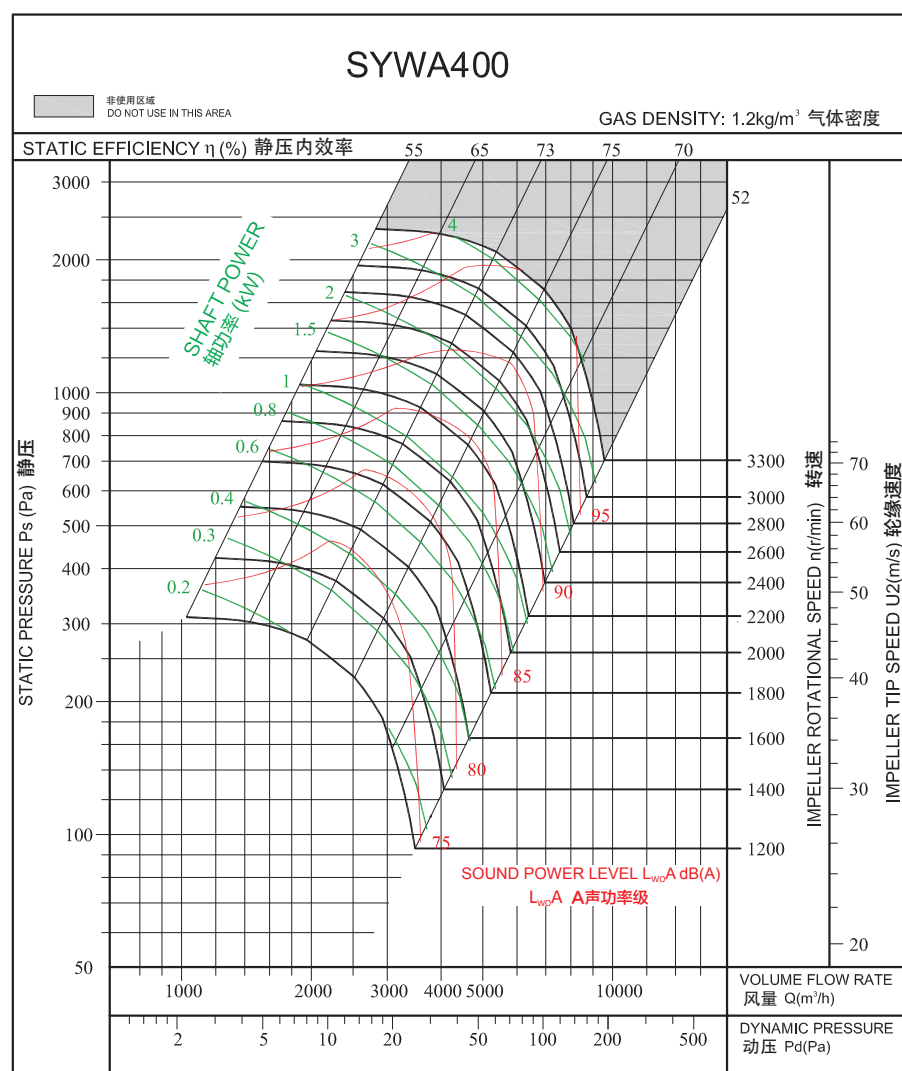

Measured in installation A according to AMCA Standard 210:

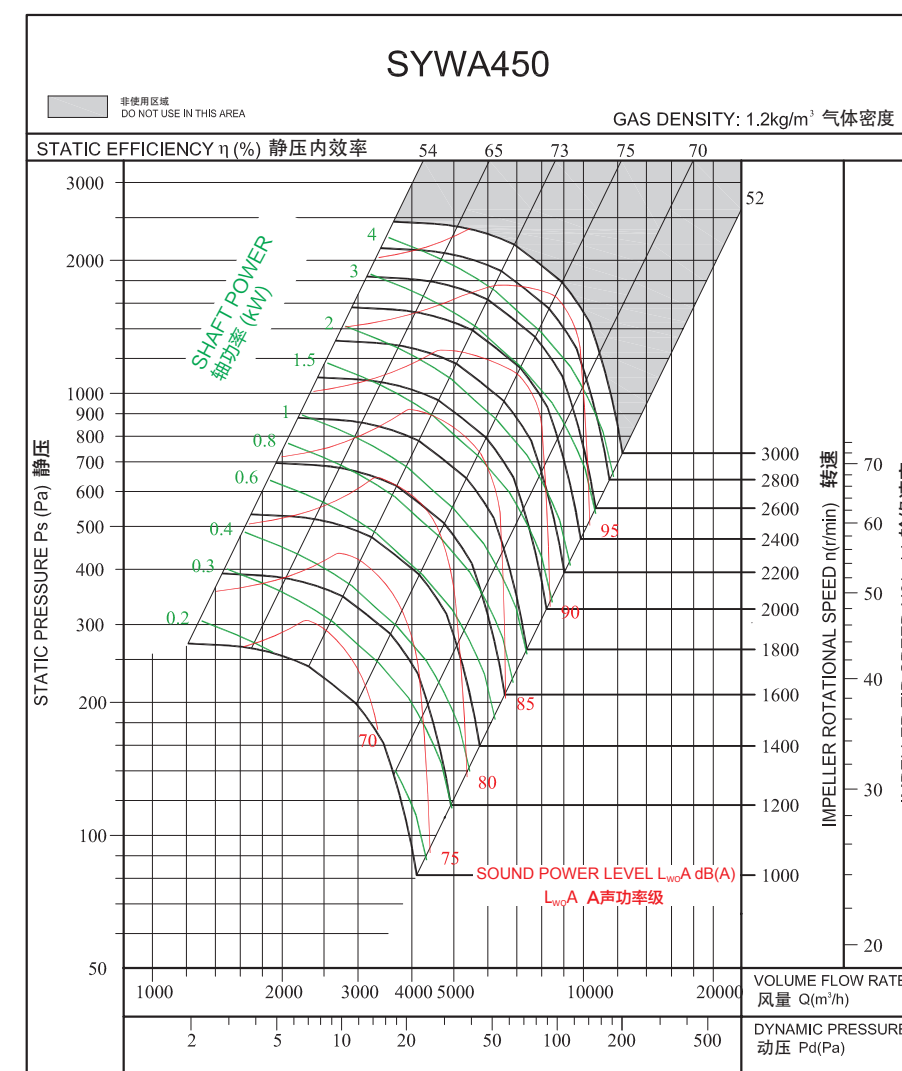
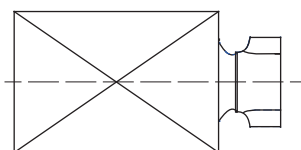

Measured in installation A according to AMCA Standard 210:

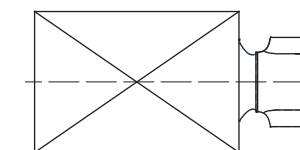

技术参数

Technical Data

Wheel diameter	叶轮直径	D = 508 mm	Fan weight	风机重量	m = 80kg
Moment of inertia	转动惯量	J = 0.567 kg·m ²	Speed limit	极限转速	n _{max} = 2600 r/min

技术参数

Technical Data

Wheel diameter	叶轮直径	D = 568mm	Fan weight	风机重量	m = 90 kg
Moment of inertia	转动惯量	J = 0.992 kg·m ²	Speed limit	极限转速	n _{max} = 2340 r/min

性能曲线

Performance Curves

经认证的性能是A类安装：自由入口，自由出口。各项性能额定值不包括附属物(附件)的影响。所示A加权声音性能额定值已按AMCA International标准301计算。所示值为安装类型A：自由入口，自由出口的声功率级（出口L_{wcA}）。

Performance certified is for installation type A: free inlet, free outlet. Performance ratings do not include the effects of appurtenances (accessories). The A-weighted sound ratings shown have been calculated per AMCA International Standard 301. Values shown are for outlet L_{wcA} sound power levels for installation type A: free inlet, free outlet.

性能曲线

Performance Curves

经认证的性能是A类安装：自由入口，自由出口。各项性能额定值不包括附属物(附件)的影响。所示A加权声音性能额定值已按AMCA International标准301计算。所示值为安装类型A：自由入口，自由出口的声功率级（出口L_{wcA}）。

Performance certified is for installation type A: free inlet, free outlet. Performance ratings do not include the effects of appurtenances (accessories). The A-weighted sound ratings shown have been calculated per AMCA International Standard 301. Values shown are for outlet L_{wcA} sound power levels for installation type A: free inlet, free outlet.

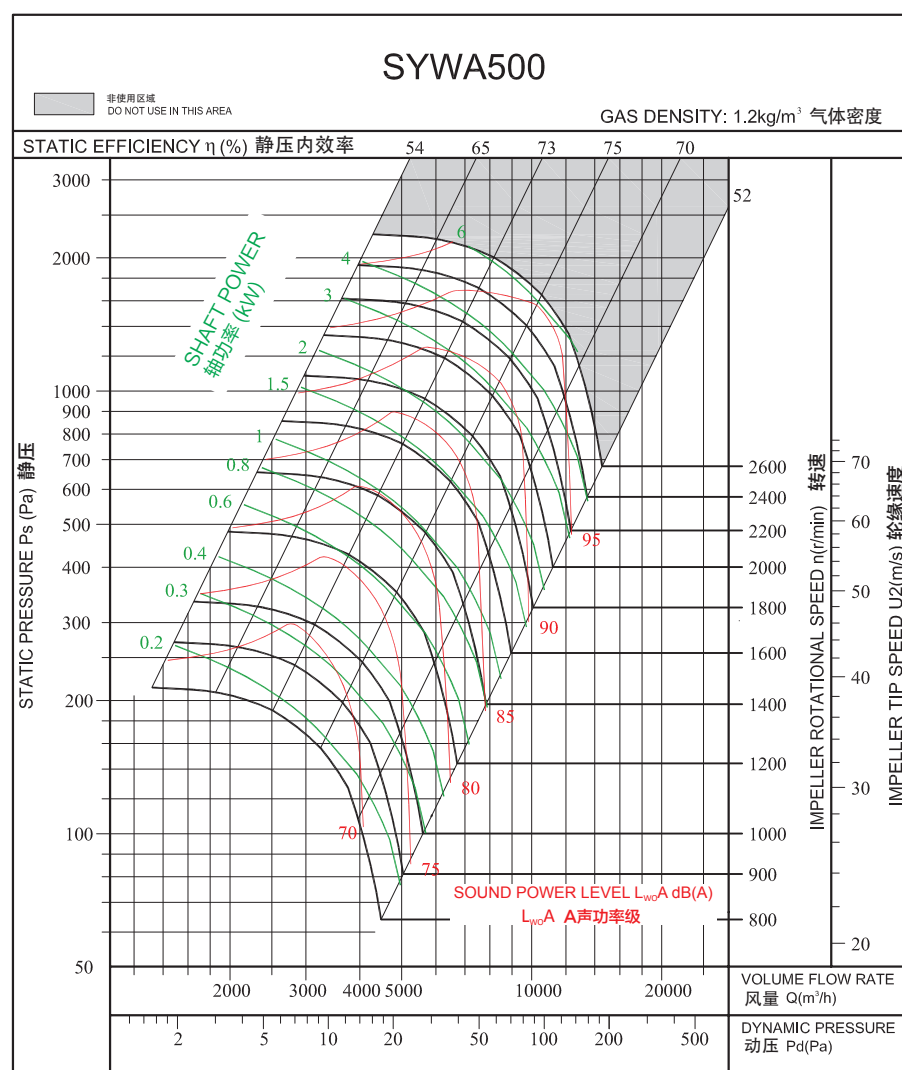

Measured in installation A according to AMCA Standard 210:

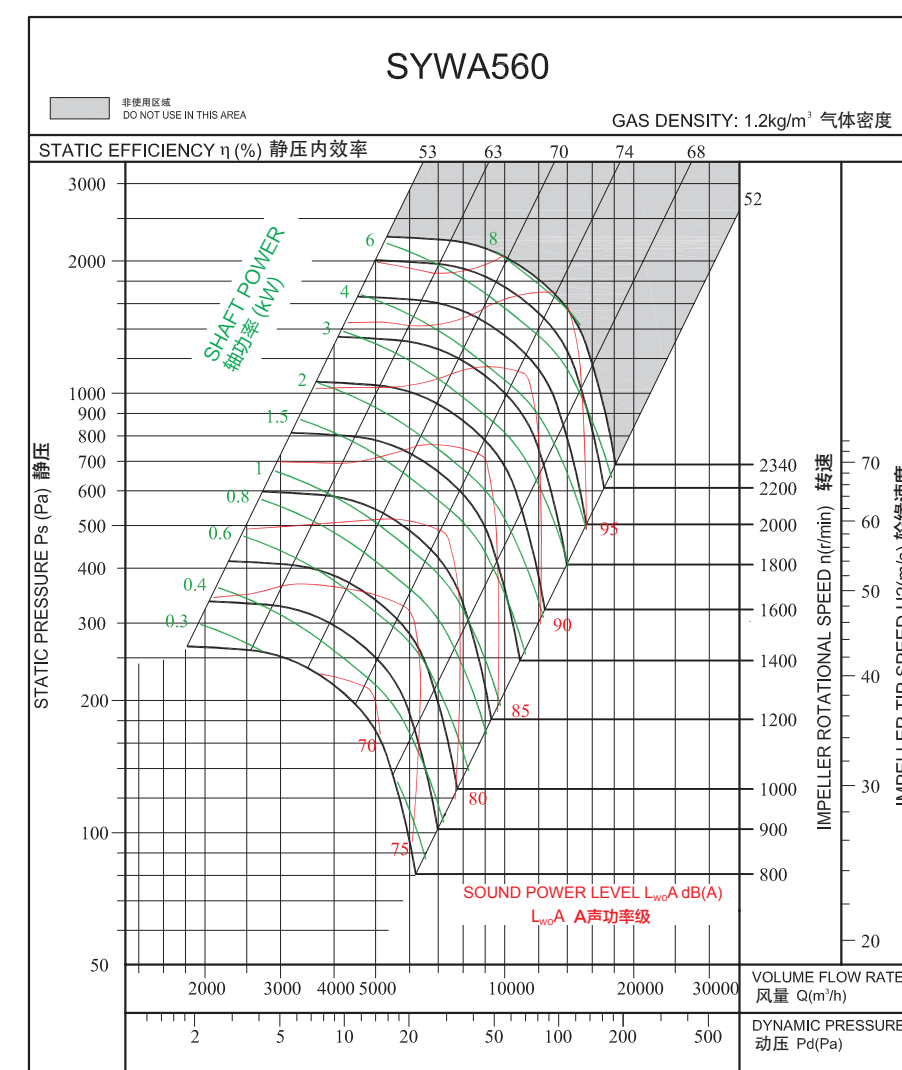
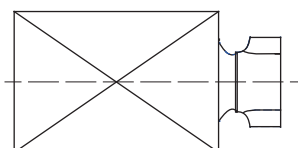

Measured in installation A according to AMCA Standard 210:

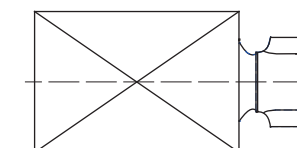

技术参数

Technical Data

Wheel diameter 叶轮直径	D = 638mm	Fan weight 风机重量	m = 110 kg
Moment of inertia 转动惯量	J = 1.602 kg·m ²	Speed limit 极限转速	n _{max} = 2120 r/min

技术参数

Technical Data

Wheel diameter 叶轮直径	D = 716mm	Fan weight 风机重量	m = 140 kg
Moment of inertia 转动惯量	J = 2.723 kg·m ²	Speed limit 极限转速	n _{max} = 1830 r/min

性能曲线

Performance Curves

经认证的性能是A类安装：自由入口，自由出口。各项性能额定值不包括附属物(附件)的影响。所示A加权声音性能额定值已按AMCA International标准301计算。所示值为安装类型A：自由入口，自由出口的声功率级（出口L_{wcA}）。

Performance certified is for installation type A: free inlet, free outlet. Performance ratings do not include the effects of appurtenances (accessories). The A-weighted sound ratings shown have been calculated per AMCA International Standard 301. Values shown are for outlet L_{wcA} sound power levels for installation type A: free inlet, free outlet.

性能曲线

Performance Curves

经认证的性能是A类安装：自由入口，自由出口。各项性能额定值不包括附属物(附件)的影响。所示A加权声音性能额定值已按AMCA International标准301计算。所示值为安装类型A：自由入口，自由出口的声功率级（出口L_{wcA}）。

Performance certified is for installation type A: free inlet, free outlet. Performance ratings do not include the effects of appurtenances (accessories). The A-weighted sound ratings shown have been calculated per AMCA International Standard 301. Values shown are for outlet L_{wcA} sound power levels for installation type A: free inlet, free outlet.

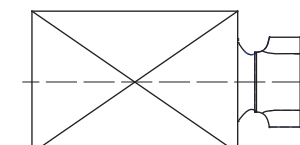
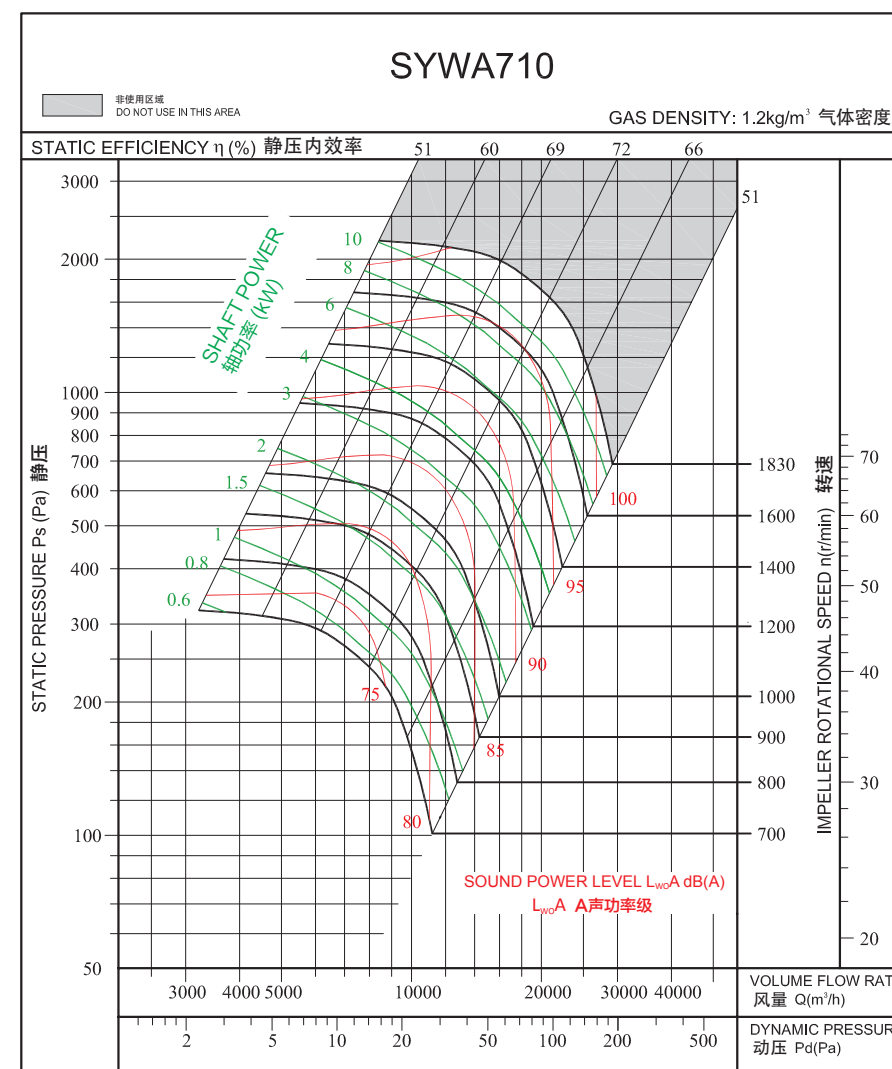
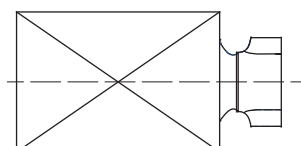
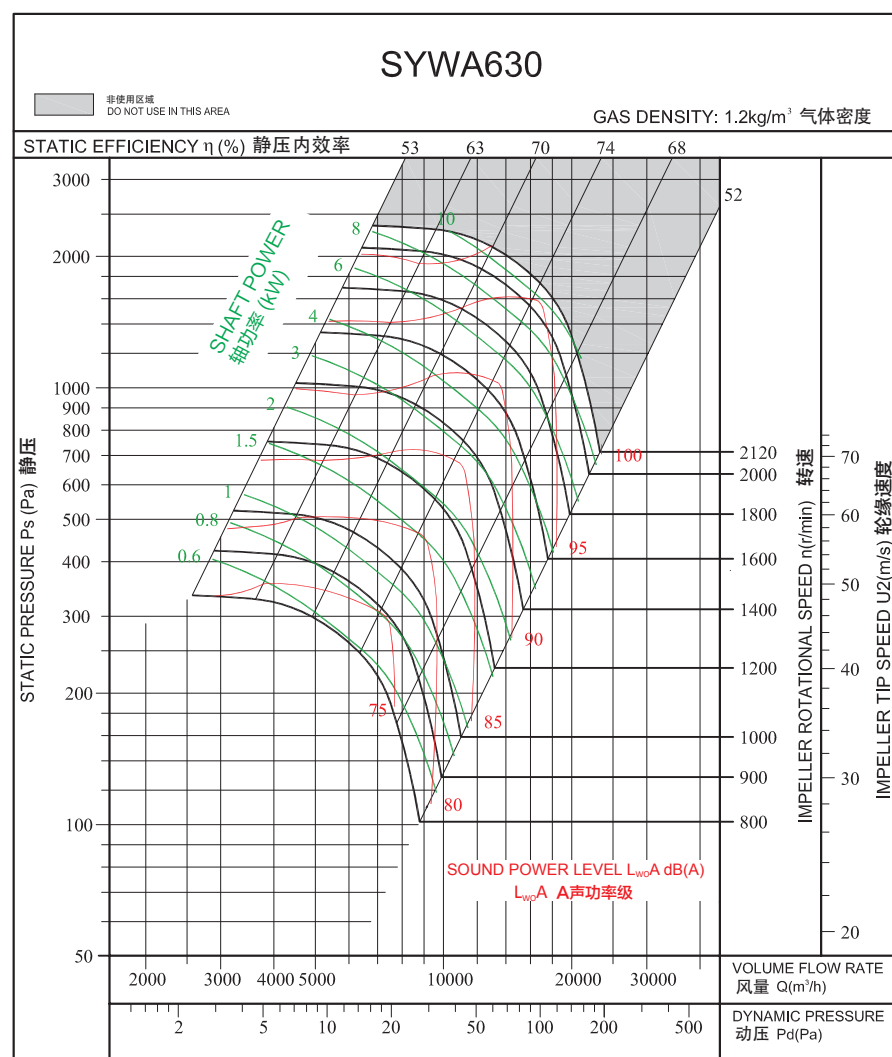

技术参数

Technical Data

技术参数

Technical Data

Wheel diameter 叶轮直径	D = 806mm	Fan weight 风机重量	m = 210 kg
Moment of inertia 转动惯量	J = 5.034 kg·m ²	Speed limit 极限转速	n _{max} = 1630 r/min

Wheel diameter 叶轮直径	D = 905mm	Fan weight 风机重量	m = 300 kg
Moment of inertia 转动惯量	J = 9.214 kg·m ²	Speed limit 极限转速	n _{max} = 1490 r/min

性能曲线

Performance Curves

性能曲线

Performance Curves

经认证的性能是A类安装：自由入口，自由出口。各项性能额定值不包括附属物(附件)的影响。所示A加权声音性能额定值已按AMCA International标准301计算。所示值为安装类型A：自由入口，自由出口的声功率级（出口L_{wcA}）。

Performance certified is for installation type A: free inlet, free outlet. Performance ratings do not include the effects of appurtenances (accessories). The A-weighted sound ratings shown have been calculated per AMCA International Standard 301. Values shown are for outlet L_{wcA} sound power levels for installation type A: free inlet, free outlet.

经认证的性能是A类安装：自由入口，自由出口。各项性能额定值不包括附属物(附件)的影响。所示A加权声音性能额定值已按AMCA International标准301计算。所示值为安装类型A：自由入口，自由出口的声功率级（出口L_{wcA}）。

Performance certified is for installation type A: free inlet, free outlet. Performance ratings do not include the effects of appurtenances (accessories). The A-weighted sound ratings shown have been calculated per AMCA International Standard 301. Values shown are for outlet L_{wcA} sound power levels for installation type A: free inlet, free outlet.

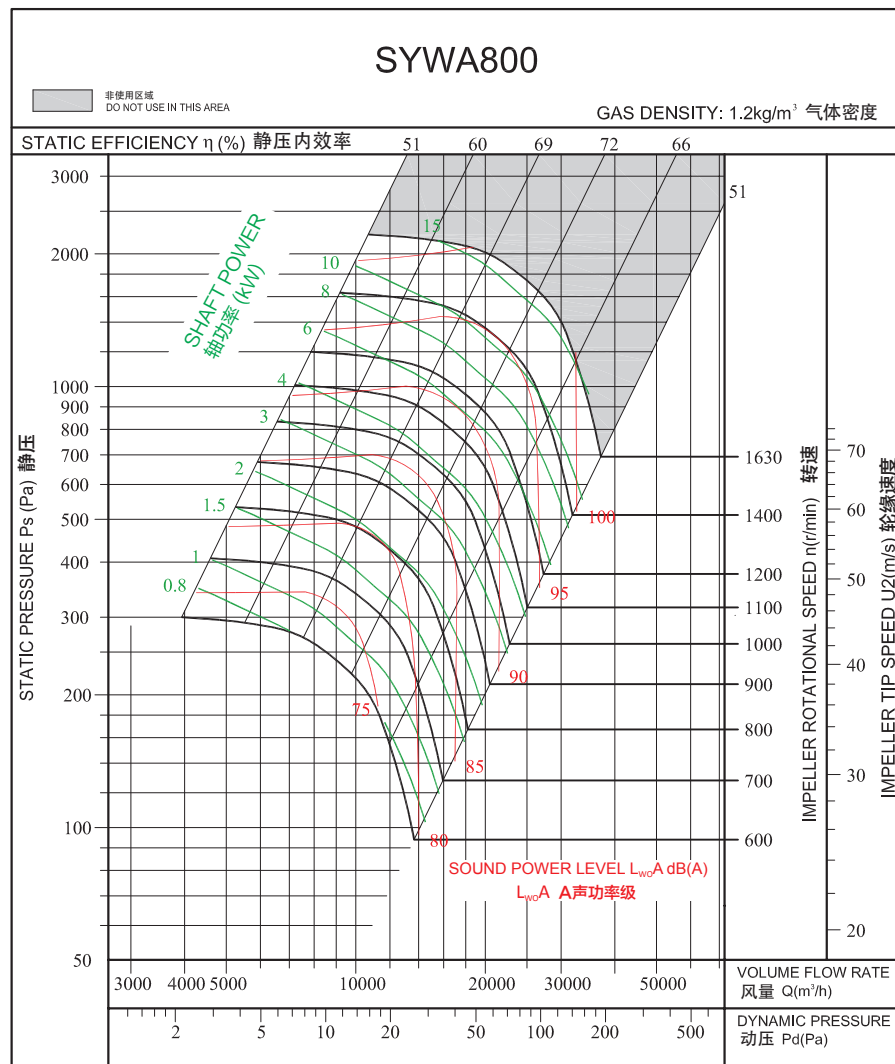

Measured in installation A according to AMCA Standard 210:

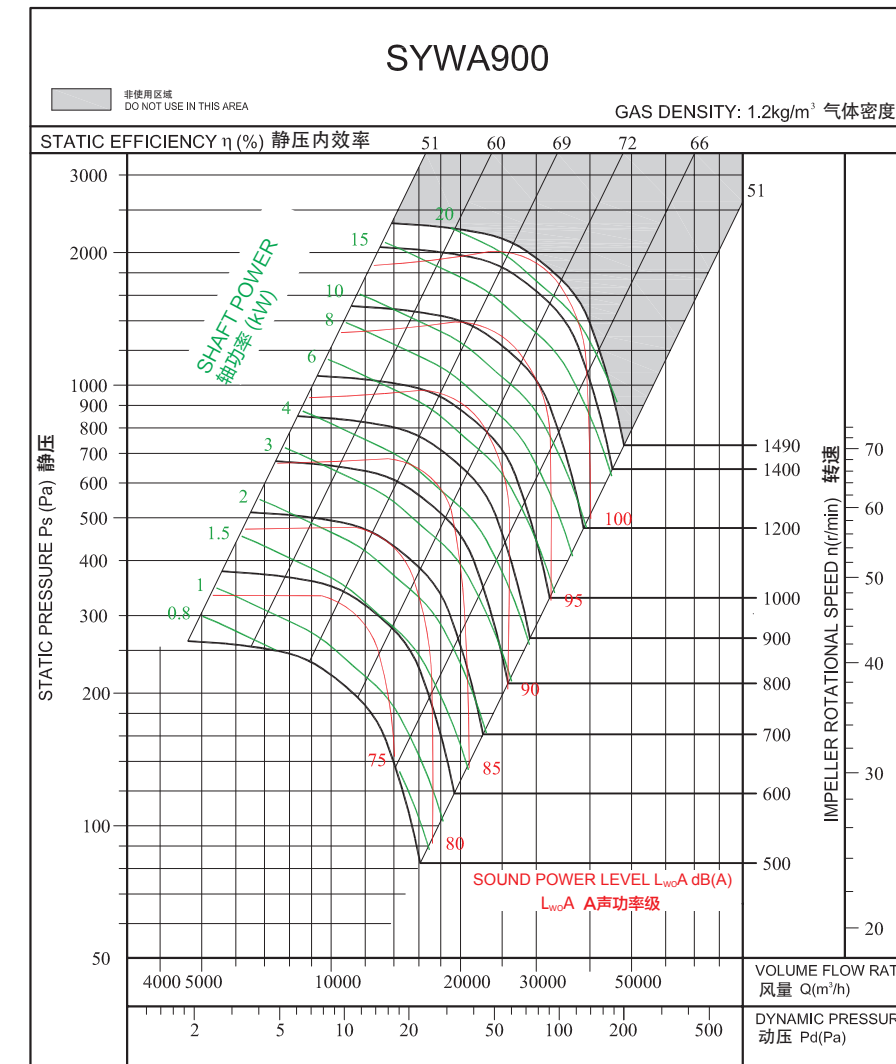
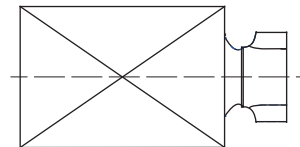

Measured in installation A according to AMCA Standard 210:

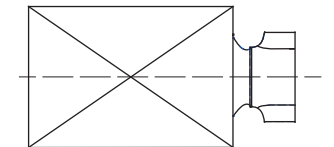

技术参数

Technical Data

Wheel diameter 叶轮直径	D = 1000 mm	Fan weight 风机重量	m = 350 kg
Moment of inertia 转动惯量	J = 14.375 kg·m ²	Speed limit 极限转速	n _{max} = 1320 r/min

技术参数

Technical Data

Wheel diameter 叶轮直径	D = 1120 mm	Fan weight 风机重量	m = 410 kg
Moment of inertia 转动惯量	J = 23.52 kg·m ²	Speed limit 极限转速	n _{max} = 1250 r/min

性能曲线

Performance Curves

经认证的性能是A类安装：自由入口，自由出口。各项性能额定值不包括附属物(附件)的影响。所示A加权声音性能额定值已按AMCA International标准301计算。所示值为安装类型A：自由入口，自由出口的声功率级（出口L_wA）。

Performance certified is for installation type A: free inlet, free outlet. Performance ratings do not include the effects of appurtenances (accessories). The A-weighted sound ratings shown have been calculated per AMCA International Standard 301. Values shown are for outlet L_wA sound power levels for installation type A: free inlet, free outlet.

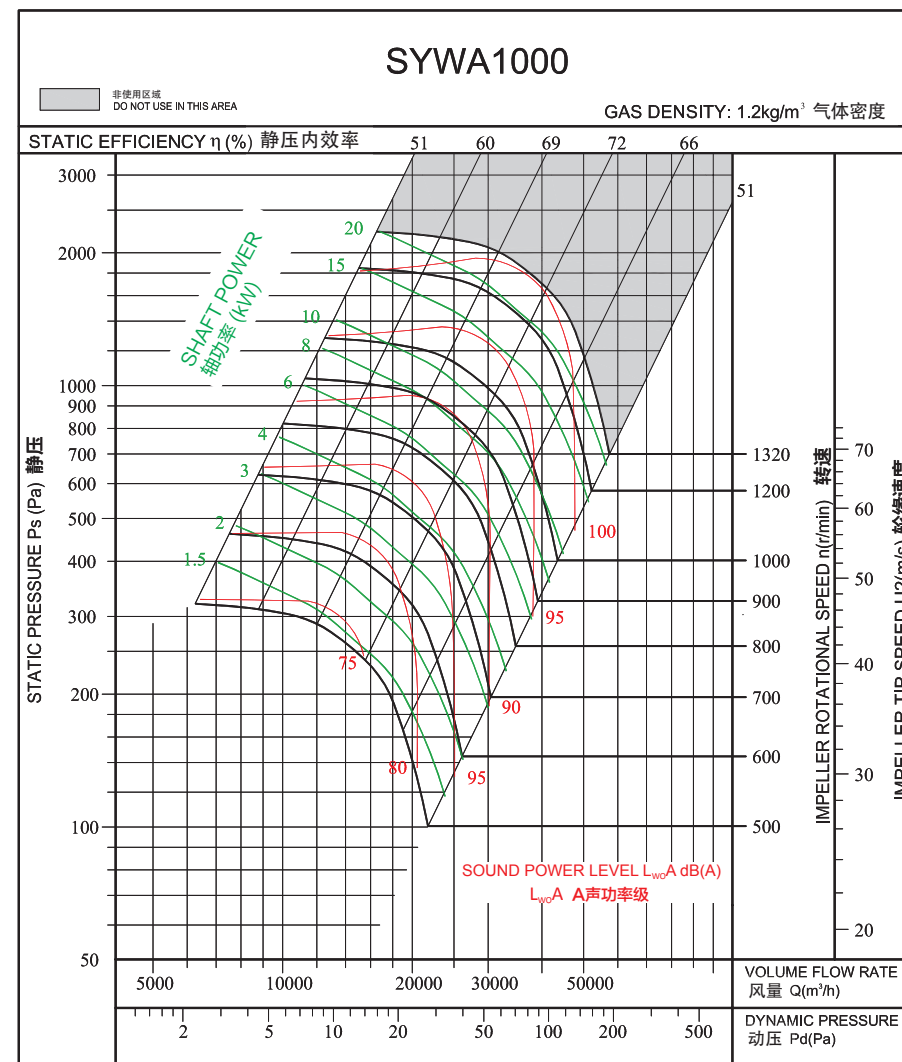

Measured in installation A according to AMCA Standard 210:

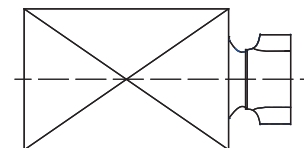

性能曲线

Performance Curves

经认证的性能是A类安装：自由入口，自由出口。各项性能额定值不包括附属物(附件)的影响。所示A加权声音性能额定值已按AMCA International标准301计算。所示值为安装类型A：自由入口，自由出口的声功率级（出口L_wA）。

Performance certified is for installation type A: free inlet, free outlet. Performance ratings do not include the effects of appurtenances (accessories). The A-weighted sound ratings shown have been calculated per AMCA International Standard 301. Values shown are for outlet L_wA sound power levels for installation type A: free inlet, free outlet.

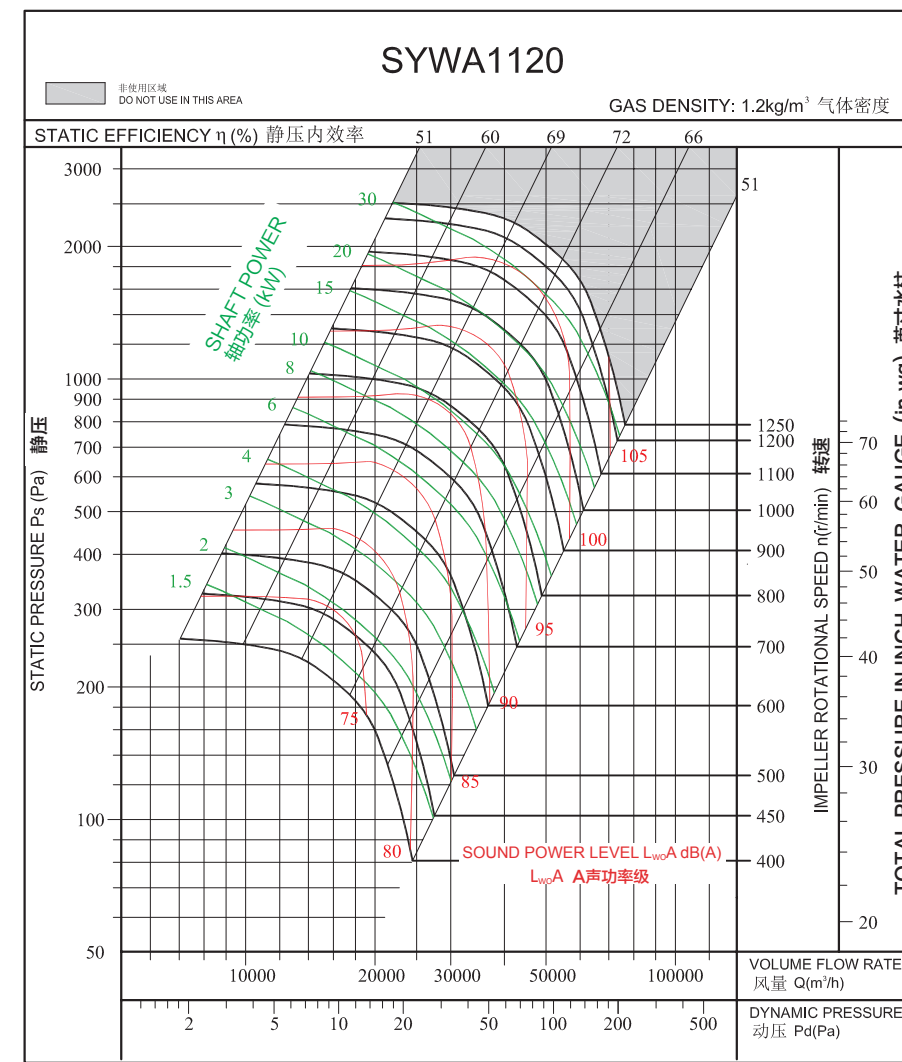

Measured in installation A according to AMCA Standard 210:

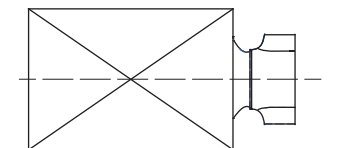

技术参数

Technical Data

Wheel diameter	叶轮直径	D = 1250 mm	Fan weight	风机重量	m = 650 kg
Moment of inertia	转动惯量	J = 37.11 kg·m ²	Speed limit	极限转速	n _{max} = 1130 r/min

技术参数

Technical Data

Wheel diameter	叶轮直径	D = 1400 mm	Fan weight	风机重量	m = 790 kg
Moment of inertia	转动惯量	J = 56.32 kg·m ²	Speed limit	极限转速	n _{max} = 1060 r/min

性能曲线

Performance Curves

经认证的性能是A类安装：自由入口，自由出口。各项性能额定值不包括附属物(附件)的影响。所示A加权声音性能额定值已按AMCA International标准301计算。所示值为安装类型A：自由入口，自由出口的声功率级（出口L_{wcA}）。

Performance certified is for installation type A: free inlet, free outlet. Performance ratings do not include the effects of appurtenances (accessories). The A-weighted sound ratings shown have been calculated per AMCA International Standard 301. Values shown are for outlet L_{wcA} sound power levels for installation type A: free inlet, free outlet.

性能曲线

Performance Curves

经认证的性能是A类安装：自由入口，自由出口。各项性能额定值不包括附属物(附件)的影响。所示A加权声音性能额定值已按AMCA International标准301计算。所示值为安装类型A：自由入口，自由出口的声功率级（出口L_{wcA}）。

Performance certified is for installation type A: free inlet, free outlet. Performance ratings do not include the effects of appurtenances (accessories). The A-weighted sound ratings shown have been calculated per AMCA International Standard 301. Values shown are for outlet L_{wcA} sound power levels for installation type A: free inlet, free outlet.

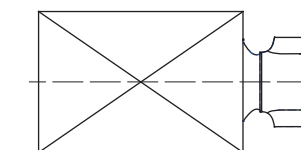
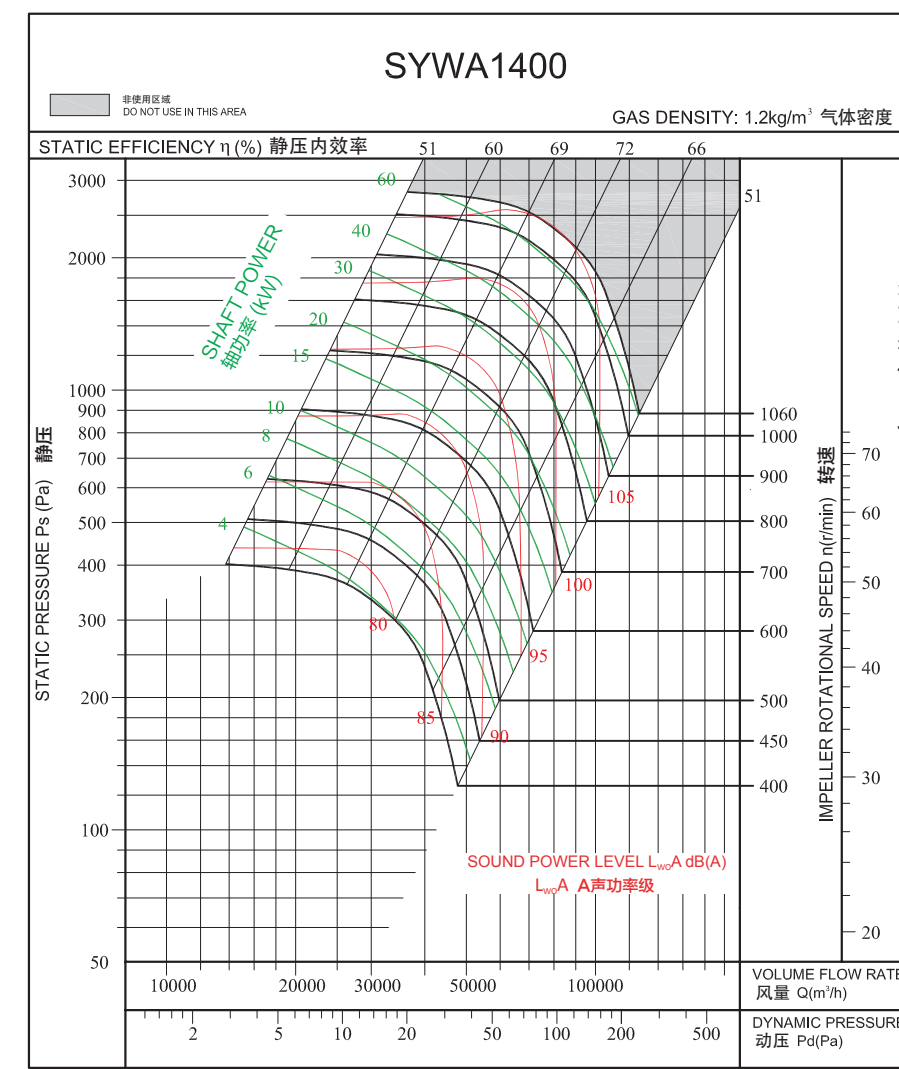
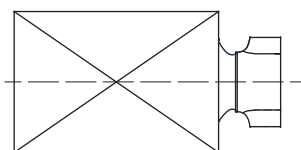
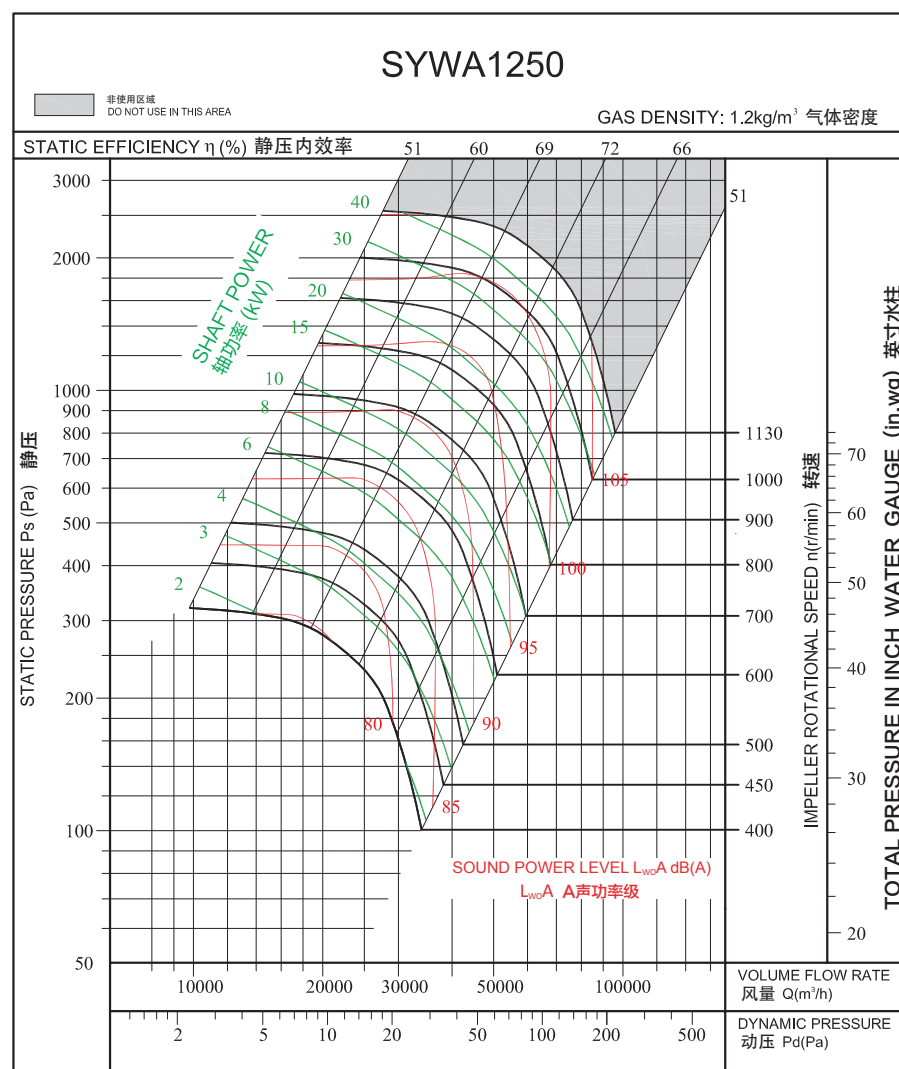

叶轮与进风圈尺寸统计表

Dimension of Wheel and Inlet Cone

SYWA系列风机外形尺寸

SYWA Series Ventilator Overall Dimension

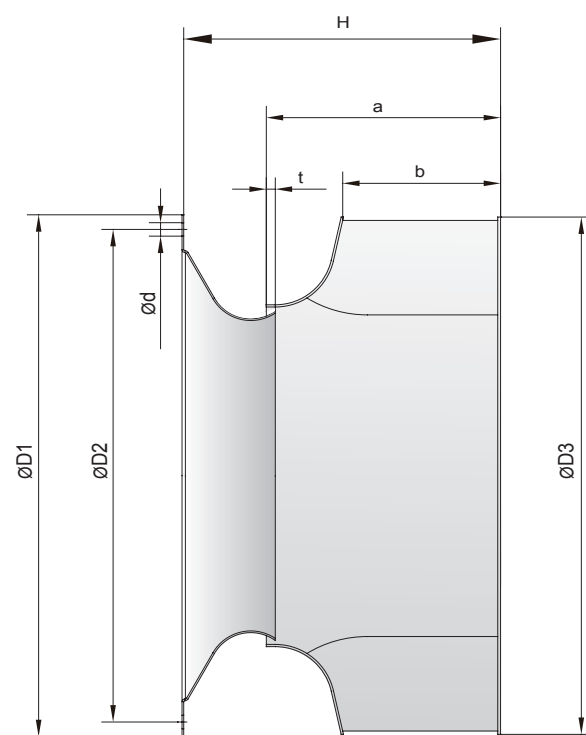

单位: mm

Dim Modle	a	b	t	ØD1	ØD2	ØD3	H	n	Ød
SYWA280	117	84	4	300	280	323	169	6	7
SYWA315	126	92	5	355	325	360	178	6	7
SYWA355	144	103	6	383	344	406	196	6	7
SYWA400	160	116	7	423	386	456	220	6	7
SYWA450	179	131	7	466	432	512	243	6	7
SYWA500	200	145	8	515	485	570	277	8	9
SYWA560	229	164	8	570	544	640	314	8	9
SYWA630	253	184	9	635	605	720	353	8	9
SYWA710	283	206	10	700	670	810	394	8	9
SYWA800	320	233	12	778	750	912	447	12	12
SYWA900	357	260	14	875	844	1023	503	12	12
SYWA1000	400	291	16	980	945	1120	561	12	12
SYWA1120	448	326	16	1044	1080	1254	639	12	12
SYWA1250	502	366	18	1220	1180	1400	696	14	14
SYWA1400	564	411	18	1360	1310	1568	796	14	14

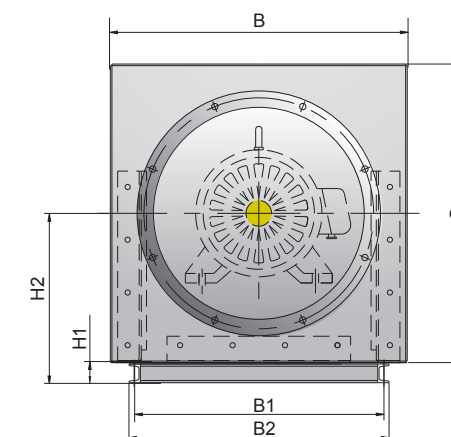
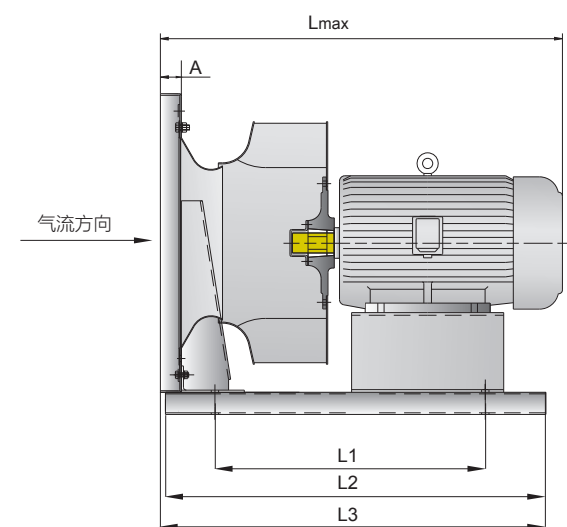

单位: mm

型号	电机机座号	A	B	C	H1	H2	L1	L2	L3	L.max	B1	B2
SYWA280	Y71-100	35	396	473	50	275	360	460	465	605	310	346
SYWA315	Y71-112	35	440	523	50	303	360	460	465	615	360	396
SYWA355	Y71-80	35	480	569	50	329	300	420	425	635	400	436
	Y90-112						380	500	505			
SYWA400	Y80-112	35	520	624	50	364	400	520	525	755	450	486
	Y132						500	620	625			
SYWA450	Y90-112	35	590	697	50	402	400	520	525	780	510	546
	Y132						500	620	625			
SYWA500	Y90-112	40	650	778	63	453	440	600	605	950	550	590
	Y132-160						620	780	785			
SYWA560	Y90-112	40	720	878	63	518	460	620	625	990	610	650
	Y132-160						660	820	825			
SYWA630	Y112	45	800	975	63	575	510	670	675	1025	685	725
	Y132-160						700	860	865			
SYWA710	Y112-132	50	880	1116	80	676	600	800	805	1125	770	810
	Y160-180						740	940	945			
SYWA800	Y132	50	1000	1250	80	750	650	850	860	1180	850	890
	Y160-180						800	1000	1010			
SYWA900	Y132	50	1120	1393	80	833	700	900	910	1240	960	1000
	Y160-180						900	1100	1110			
SYWA1000	Y160-200	50	1250	1536	80	911	1000	1200	1210	1365	1080	1120
	Y200-225						1200	1400	1410			
SYWA1120	Y250-280	60	1400	1864	100	1032	1400	1600	1610	1650	1210	1250
	Y280-315						1500	1700	1710			
SYWA1250	Y225-250	60	1560	2078	100	1139	1300	1500	1510	1800	1360	1400
	Y280-315						1500	1700	1710			
SYWA1400	Y250	60	1750	2330	100	1265	1400	1600	1610	1950	1500	1540
	Y280-315						1600	1800	1810			

本样本中所述的风机特性,如尺寸、性能参数等,本公司保留更改的权利,恕不另行通知;如有不明之处,请来电询问。
This fan features described in the sample, such as size, performance parameters, the Company reserves the right to change without notice; if unknown place, please call us.