

## Application

The EXA-645 combination louver features stationary drainable louver blades to protect against water penetration and an integral airfoil blade control damper to allow positive shutoff protection of air intake and exhaust openings. The EXA-645 has a leakage class rating of 1A and is available in a wide array of anodized and painted finishes including custom color matching. These units are also available with a variety of factory mounted electric or pneumatic actuators.

## Standard Construction

**Material:** Mill finish 6063-T5 extruded aluminum.

**Frame:** 6" deep × 0.081" thick (152 × 2) channel.

### Blades:

Front: 37.5° × 0.081" (2) thick drainable style.

Back: 45° × 0.125" (3) thick operable airfoil style.

**Screen:** 1/2" × 0.063" (12.7 × 1.6) expanded and flattened aluminum.

**Axles:** 1/2" (13) diameter steel hex.

**Linkage:** Concealed in frame.

**Low Leakage Seals:** TPV blade edge and flexible metal jamb.

**Bearings:** Synthetic.

**Mullion:** Visible.

**Minimum Size:** 12" × 9" (305 × 229)

**Maximum Size:** Single section:  
60" × 96" (1524 × 2438)  
Multiple section: Unlimited

## Options

- Factory finish:
  - High Performance Fluoropolymer
  - Baked Enamel/Polyester
  - Clear or Color Anodized, Class 1
  - Prime Coat
- Flange Frame:
  - 1 1/2" (38) flange
  - Custom-size flange
  - Stucco flange
  - Glazing frame
- Welded construction.
- Alternate bird or insect screens.
- Filter racks.
- Head and/or sill flashing.
- Factory mounted electric or pneumatic actuator.
- Sleeve (galvanized steel):
  - 20-GA  16-GA
- Installation hardware:
  - Clip angles  Continuous angles

## Ratings

**Free Area:** [48" × 48" (1219 × 1219) unit]: 8.1 ft<sup>2</sup> (0.75 m<sup>2</sup>)  
50.4%

**Leakage:** Class 1A (3 cfm/sq.ft. @ 1 in. wg.)  
(15.2 L/s/m<sup>2</sup> @ 0.2 kPa)

### Performance @ Beginning Point of Water Penetration

**Free Area Velocity:** 1,085 fpm (5.51 m/s)

**Air Volume Delivered:** 8,756 cfm (4.13 m<sup>3</sup>/s)

**Pressure Loss:** 0.11 in.wg. (27 Pa)

**Velocity @ 0.15 in.wg. Pressure Loss:** 1,272 fpm (6.46 m/s)

**Design Load:** 25 psf

**Operating Temperature Range:** -20°F to +180°F (-7°C to +82°C)

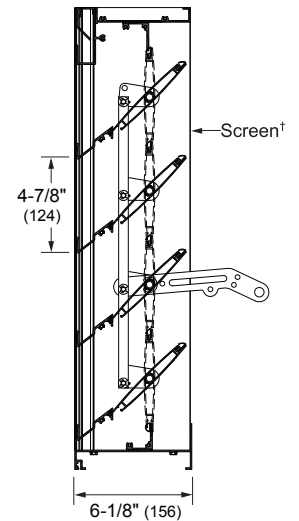
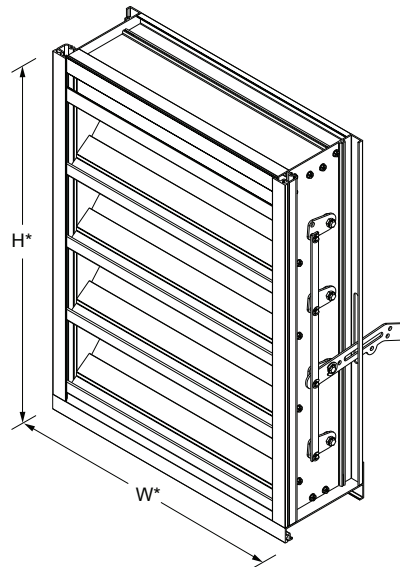

**Model EXA-645**  
(standard)  
\*Louver dimensions furnished approximately 1/2" (13) undersize.

**Vertical Section**  
†Screen adds approximately 3/16" (5) to louver depth.

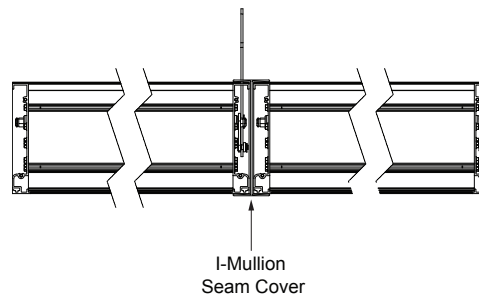

**Vertical Mullion**  
(standard)

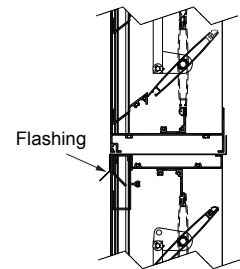

**Horizontal Mullion**  
(standard)

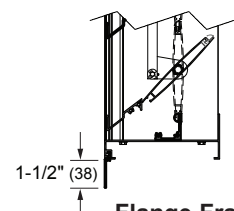

**Flange Frame**  
(optional)



### Certified Ratings:

All-Lite certifies that the model EXA-645 shown herein is licensed to bear the AMCA seal. The ratings shown are based on tests and procedures performed in accordance with AMCA Publication 511 and comply with the requirements of the AMCA Certified Ratings Program. The AMCA Certified Ratings seal applies to air performance, water penetration and air leakage ratings.

# Performance Data

## Free Area (ft<sup>2</sup>)

Width (Inches)

| Height (Inches) | 12  | 18  | 24  | 30   | 36   | 42   | 48   | 54   | 60   |
|-----------------|-----|-----|-----|------|------|------|------|------|------|
| 9               | 0.1 | 0.2 | 0.3 | 0.4  | 0.4  | 0.5  | 0.6  | 0.7  | 0.7  |
| 12              | 0.3 | 0.5 | 0.6 | 0.8  | 1.0  | 1.1  | 1.3  | 1.5  | 1.7  |
| 18              | 0.5 | 0.8 | 1.2 | 1.5  | 1.8  | 2.1  | 2.4  | 2.7  | 3.0  |
| 24              | 0.7 | 1.2 | 1.7 | 2.1  | 2.6  | 3.0  | 3.5  | 3.9  | 4.4  |
| 30              | 1.0 | 1.5 | 2.1 | 2.7  | 3.3  | 3.9  | 4.4  | 5.0  | 5.6  |
| 36              | 1.2 | 1.9 | 2.6 | 3.3  | 4.0  | 4.7  | 5.4  | 6.1  | 6.8  |
| 42              | 1.5 | 2.5 | 3.4 | 4.3  | 5.3  | 6.2  | 7.1  | 8.1  | 9.0  |
| 48              | 1.8 | 2.9 | 3.9 | 5.0  | 6.1  | 7.2  | 8.1  | 9.4  | 10.4 |
| 54              | 2.0 | 3.2 | 4.4 | 5.6  | 6.8  | 8.0  | 9.2  | 10.4 | 11.7 |
| 60              | 2.2 | 3.5 | 4.9 | 6.2  | 7.5  | 8.9  | 10.2 | 11.5 | 12.9 |
| 66              | 2.6 | 4.1 | 5.7 | 7.2  | 8.8  | 10.4 | 11.9 | 13.5 | 15.0 |
| 72              | 2.8 | 4.5 | 6.2 | 7.9  | 9.7  | 11.4 | 13.1 | 14.8 | 16.5 |
| 78              | 3.0 | 4.9 | 6.7 | 8.5  | 10.4 | 12.2 | 14.0 | 15.9 | 17.7 |
| 84              | 3.2 | 5.2 | 7.2 | 9.1  | 11.1 | 13.0 | 15.0 | 17.0 | 18.9 |
| 90              | 3.6 | 5.8 | 8.0 | 10.1 | 12.3 | 14.5 | 16.7 | 18.9 | 21.0 |
| 96              | 3.8 | 6.2 | 8.5 | 10.8 | 13.1 | 15.5 | 17.8 | 20.1 | 22.4 |

## Selection Criteria

Follow the steps listed below to calculate the louver size needed to satisfy the required air volume while minimizing the adverse effects of water penetration and pressure loss.

1. Determine the Free Area Velocity (FAV) at the maximum allowable pressure loss using the *Pressure Loss* chart to the left. While job conditions vary, typically, the maximum allowable pressure loss should not exceed 0.15 in.wg., and the FAV for 0.15 in.wg. pressure loss is listed on the front page of this sheet.
2. **Intake Applications** If the FAV at the Beginning Point of Water Penetration (shown below) is less than the FAV from step 1, then use the FAV at the Beginning Point of Water Penetration in step 3, otherwise use the FAV from step 1.
- Exhaust Applications** Use the FAV from step 1 in step 3.
3. Calculate the total louver square footage required using the following equation.

$$\frac{\text{Required Air Volume (cfm)}}{\text{FAV (fpm)}} = \frac{\text{Required Louver (Free-Area) Size (ft}^2\text{)}}{\text{Size in ft}^2}$$

4. Using the *Free Area* chart left, select a louver width and height that yields a free area ft<sup>2</sup> greater than or equal to the required louver size from step 3.

## Pressure Loss

(Data corrected to standard air density)

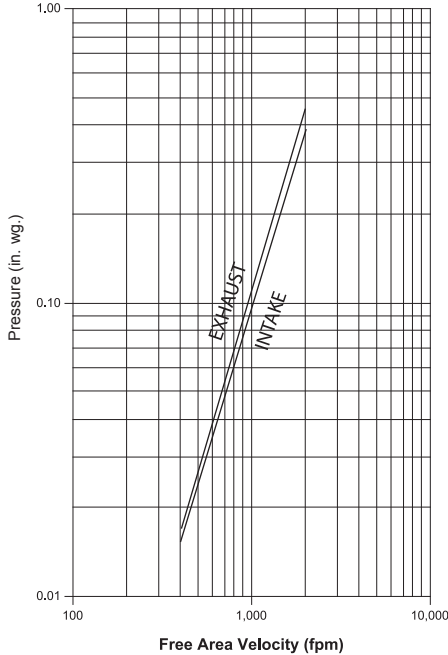

Louver Test Size = 48" x 48" (1219 x 1219)

Pressure loss tested in accordance with Figure 5.5 of AMCA Standard 500-L.

## Air Leakage

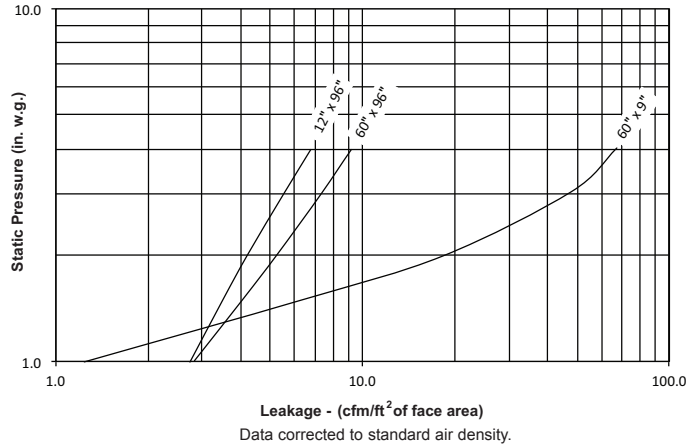

### NOTES:

1. Leakage testing in accordance with Figure 5.4, 5.5 and 6.6A of AMCA Standard 500-L.
2. Data are based on the maximum torque of 10.7 in lb/sq. ft. (13.0 N-m/sq. m) applied to the louver during the test.
3. Air leakage is based on operation between 50°F - 104°F (10°C - 40°C).

## Water Penetration

Beginning Point of Water Penetration = 1085 fpm

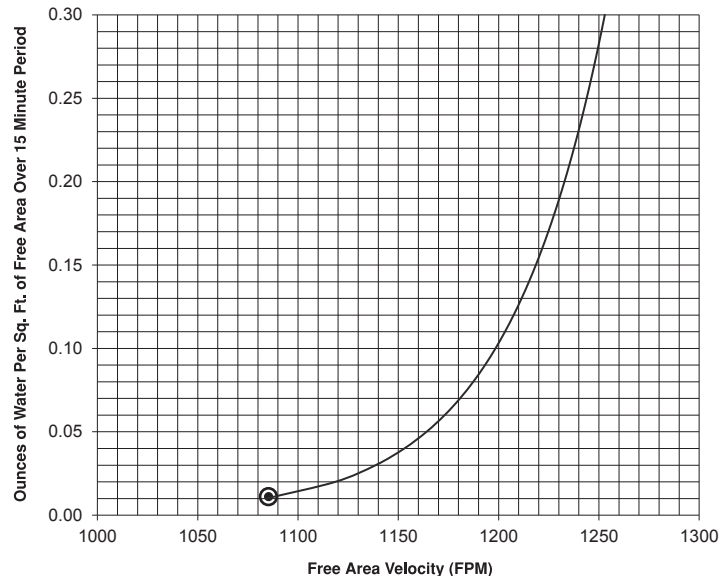

## Water Penetration

AMCA defines the beginning point of water penetration as the free area velocity at the intersection of a simple linear regression of test data and the line of 0.01 ounces of water per square foot of free area measured through a 48" x 48" louver during a 15 minute period. The AMCA water penetration test provides a method for comparing louver models and designs as to their efficiency in resisting the penetration of rainfall under specific lab conditions. All-Lite recommends that intake louvers are selected with a reasonable margin of safety below the beginning point of water penetration in order to avoid unwanted penetration during severe storm conditions.

Information is subject to change without notice or obligation.

NOTE: Dimensions in parentheses ( ) are millimeters.