

Fans & Blowers

Twin City

Air Moving Solutions.



MODULAR PLENUM FANS

MPQN | MPQS

PlenumFans

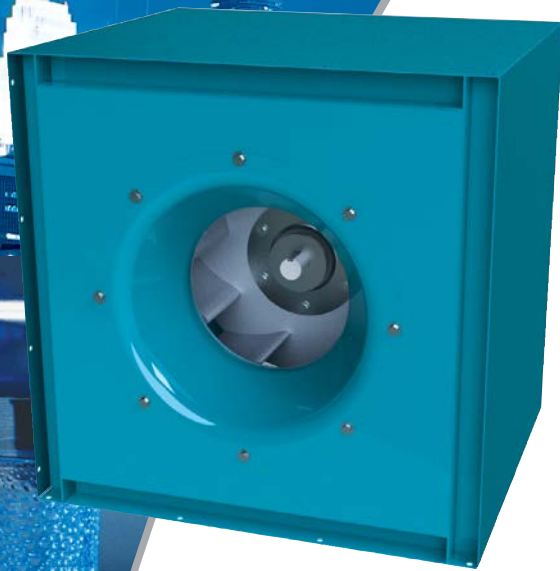

Inlet View

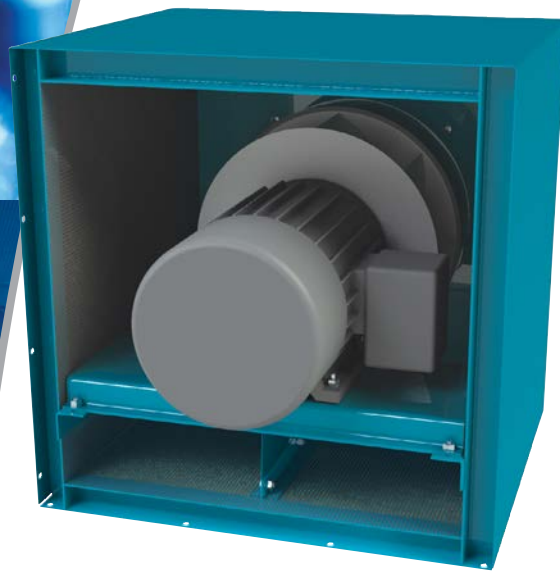

Drive End View



Twin City Fan & Blower certifies that the Model MPQN Plenum Fans shown herein are licensed to bear the AMCA Seal. The ratings shown are based on tests and procedures performed in accordance with AMCA Publication 211 and AMCA Publication 311 and comply with the requirements of the AMCA Certified Ratings Program.

Refer to Catalog 491 for sound power levels.

Models MPQN | MPQS

The MPQN and MPQS offer many of the same advantages of the venerable EPQN plenum fan. The MPQN and MPQS can be used as a single fan or in parallel to construct a multiple fan system. By using multiple MPQN fans in parallel, sound power levels in low octave bands can be significantly reduced over alternative fan selections. In addition, considerable axial space savings is achieved over a single fan selection.

Twin City Fan & Blower, the world's largest supplier of plenum fans, offers the Modular Plenum Fan (MPQN), AMCA licensed for sound and air.

Sizes

12" to 49" Wheel Diameters

Performance

Airflow to 76,000 CFM

Static pressure to 12" w.g.

Classes

Class II available in sizes 122 to 490.

Class III available in sizes 182 to 490.

See dimensional drawing on page 10.

Fan Application

Plenum fans are unhooded fans designed to operate inside of field-fabricated or factory-built air handling units.

The fan wheel pressurizes the entire surrounding air plenum in which the fan is installed, allowing air ducts from any direction to be directly connected to the air handling unit enclosure. This design generally saves space by eliminating the fan housing, transitions, and diffusers within the air handling unit.

Plenum fans have found a ready acceptance in the air conditioning industry. In addition, the construction versatility, adaptability in the direction of the discharges, suitability for internal isolation and application of sound panels, and generally lower cost makes it a very popular fan arrangement.

The MPQN and MPQS fans, when used in parallel, can offer further advantages over a standard plenum fan. By using multiple fans in parallel, uniform flow can be achieved with less axial length in a given air handling unit. The use of multiple MPQN fans in parallel can also serve to reduce sound levels, possibly eliminating the need for additional sound attenuation within the unit.

Arrangements

Arrangement 4 (Horizontal)

Direct drive Arrangement 4 mounts the fan wheel directly onto the motor shaft. This arrangement provides a compact fan/motor unit which eliminates belt residue and requires less maintenance than other arrangements.

For these reasons, Arrangement 4 modular plenum fans are widely used in cleanroom, pharmaceutical, and other critical applications.

The MPQN and MPQS can be selected to provide desired performance at direct drive, synchronous, motor speeds. The MPQN and MPQS can also be selected to operate at peak efficiency at non-synchronous motor speeds, through the use of a variable frequency drive (VFD).

Compact & Configurable Design

Space and air-handling unit design are often key considerations in the selection of plenum fans, making the compact, configurable modular Arrangement 4 an ideal choice.

The Arrangement 4 configuration places the motor mounting within the framework of the fan itself. This allows for a simple mounting option for an individual modular fan within an air-handling unit.

This compact design also allows for easy stacking and configurable mounting and operating modular fans in parallel.

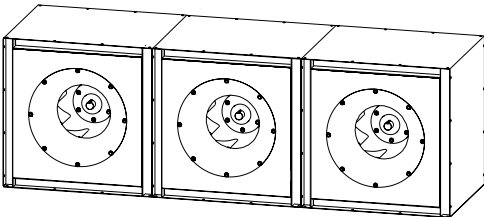
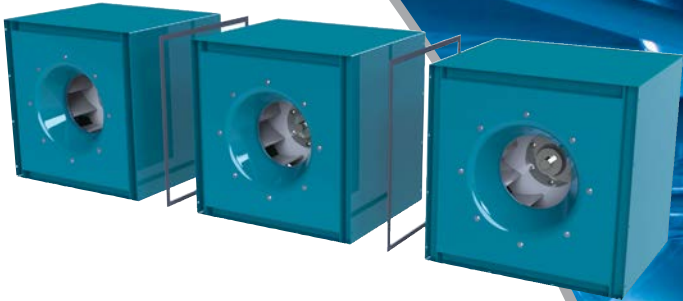

1 x 3 Horizontal Layout

FAN SIZE	MAXIMUM STACKING HEIGHT
122	3
150	3
165	3
182	3
200	3
222	3
245	3
270	2
300	2
330	2
365	2
402	1
445	1
490	1

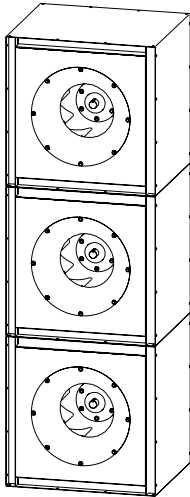

3 x 1 Vertical Layout



©2012 Twin City Fan Companies, Ltd. All rights reserved throughout the world. Catalog illustrations cover the general appearance of Twin City Fan & Blower products at the time of publication and we reserve the right to make changes in design and construction at any time without notice.

MPQN Advantage



The MPQN plenum fans offer unique performance features that are beneficial for many sound sensitive and higher pressure applications. The fan system is advantageous by providing uniform air distribution downstream of the fan, allowing for better air distribution through AHU components. The use of multiple fans in parallel allows a shorter AHU (in axial direction of flow), and provides redundancy for critical fan applications.

The MPQN features a 12-bladed airfoil wheel versus the 8- to 10-bladed wheels with most other competition. The "Q" in the MPQN designates for Better Noise Quality. Noise quality is a subjective description for noise that is less objectionable.

The design provides lower sound power levels at the lower octave bands which are the most difficult to attenuate. Furthermore, the 12-bladed fan impeller offers a higher blade pass frequency. This in turn transfers sound power levels to the higher octave bands (Figure 1), which allows for easier attenuation of the noise. Sound levels are often influenced by the noise occurring at the blade pass frequency (Blade Pass Frequency = RPM x Number of blades/60). In many applications, the use of the MPQN design will move the blade pass frequency from the 2nd octave band to the 3rd octave band. Acoustic silencers will normally perform about 10 dB better in the 3rd band.

With the use of the 12-bladed impeller, sound quality is improved by reducing the change of abrupt sound levels between neighboring octave bands, providing a more balanced sound level across the octave bands. Although the overall A-weighted sound power levels of a nine-bladed fan may be slightly lower, the sound "quality" of the 12-bladed MPQN fan may be desirable for the application as it is more pleasing to the human ear.

The MPQN offers the benefit of reduced low-frequency casing radiated noise due to the small lattice structure opening and end reflection. The insulated housing absorbs some noise generated by the fan, and the decreased size of the discharge opening results in a degree of attenuation due to end reflection.

Figure 1 demonstrates the sound comparison between the single plenum fan and the multi-fan system with 12-bladed wheel and insulated enclosure. The multi-fan system generates less outlet sound power levels at the lower frequencies.

Outlet Sound Power Level Comparison

Selection Point: 34,000 CFM @ 4"SP

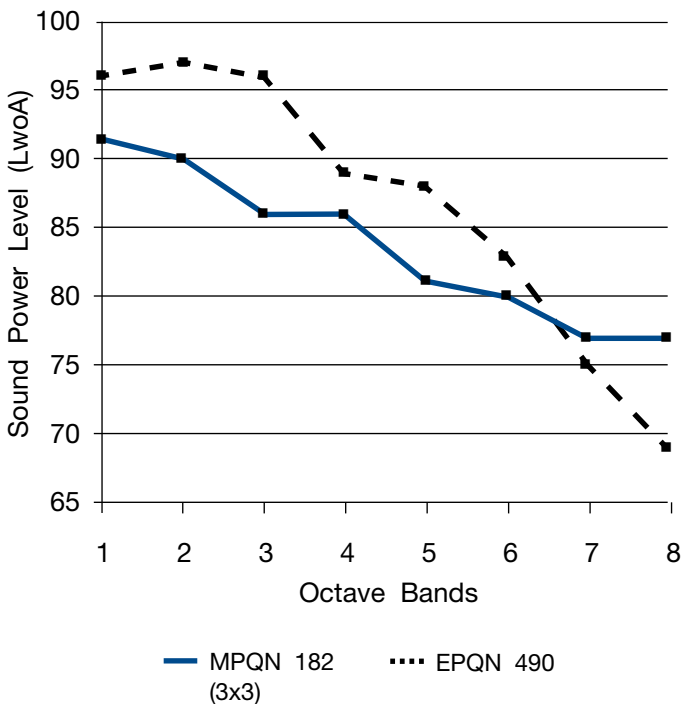

Figure 1

Sound Power	1	2	3	4	5	6	7	8	LwoA
MPQN 182 (3 x 3)	92	90	86	86	81	80	77	77	88
EPQN 490	96	97	96	89	88	83	75	69	93

Construction Features

Wheels

High efficiency, non-overloading airfoil wheels are provided on all sizes. Aluminum wheels using extruded aluminum blades are standard, a popular choice for applications requiring precision balance and improved reliability.

Inlet Cones

Heavy-gauge, spun steel inlet cones are closely matched to the wheel intake rim to ensure efficient and quiet operation.

Serviceability

Class II MPQN and MPQS fans feature a bolt-on motor base allowing for easy service by sliding out the motor/impeller assembly.

Structural Frame

Frames are constructed of heavy-gauge steel, continuously welded at all connections for maximum strength and rigidity. Mounting the MPQN and MPQS as a

parallel system allows for low vibration levels due to the unique individual rigid housings and vibration dampening gasket mounted between the fans.

Sound Insulation (MPQN only)

The sheet metal module encloses sound insulation for sound attenuation. Insulation is protected with both a vapor barrier for IAQ (indoor air quality) and galvanized, perforated steel maintaining sound attenuation while preventing insulation shedding on the air path side.

Isolation

Sizes 122-270 are designed to operate at adequate vibration levels where spring isolation is not essential. All sizes are designed to mount directly onto spring isolators when vibration isolation is preferred. Twin City Fan & Blower Engineering can also provide custom vibration isolation solutions for parallel fan systems.

Flow Measurement System

Piezometer Ring (Airflow Measuring System)

A piezometer ring is available on plenum fans, as well as other Twin City Fan housed fans, as part of an airflow measuring system, based on the principle of a flow nozzle. The inlet cone of the fan is used as the flow nozzle. The flow can be calculated by measuring the pressure drop through the inlet cone. No tubes or sensors are inserted in the high velocity airstream which could obstruct airflow.

The system consists of a piezometer ring mounted at the throat and a static pressure tap mounted on the face of the inlet cone. A differential pressure transducer and digital display can also be provided.

The pressure drop is measured from the tap located on the face of the inlet cone to the piezometer ring in the throat. The inlet tap is connected to the high-

*Piezometer Ring
Mounted at Throat
of Inlet Cone*

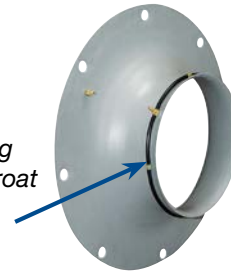

pressure side of the transducer and the piezometer ring is connected to the low-pressure side. See diagram on right.

Based on Twin City Fan laboratory tests, the system was determined to be accurate within +/-5%.

Refer to Twin City Fan Engineering Supplement ES-105.

NOTE: Twin City Fan does not recommend placement of flow measuring probes inside the fan inlet cone in the path of airflow. These devices create disturbances and unpredictable performance losses. Twin City Fan will not be responsible for loss of performance due to such devices.

Inlet Screen

Heavy-gauge barbecue grill style inlet screen that nests in the inlet funnel for personnel protection on non-ducted inlets.

Isolation Gasket

Isolation gaskets designed to separate MPQN or MPQS fans from one other when used in parallel are standard accessories on all MPQN and MPQS fans when specified.

Accessories

Shaft Grounding Ring (SGR)

Recommended for all MPQN and MPQS fans, a shaft grounding ring is mounted to the motor providing motor bearing protection. By diverting variable frequency drive (VFD) induced stray voltages to ground through the shaft grounding ring instead of the motor bearings, motor life is extended.

Maximum RPM, Wheel Weights, & WR²

FAN SIZE	WHEEL DIA. (IN.)	CLASS II			CLASS III		
		MAX. RPM (70°F)	WT. (LB)	WR ² (LB-FT)	MAX. RPM (70°F)	WT. (LB)	WR ² (LB-FT)
122	12.40	3800	9	0.9	N/A	N/A	N/A
150	13.98	3800	12	1.7	N/A	N/A	N/A
165	15.75	3468	15	2.9	N/A	N/A	N/A
182	18.25	2930	18	6.1	3767	21	6.2
200	20.00	2674	21	7.4	3438	24	9.3
222	22.25	2403	30	12	3090	34	15
245	24.50	2183	35	21	2806	38	22
270	27.00	1981	40	29	2546	47	32
300	30.00	1783	54	51	2291	58	52
330	33.00	1620	67	76	2083	72	77
365	36.50	1465	79	112	1884	84	114
402	40.25	1329	93	165	1708	98	166
445	44.50	1202	135	253	1545	142	256
490	49.00	1091	164	391	1403	174	535

Bare Fan Weights

FAN SIZE	WHEEL DIA. (IN.)	CLASS II	CLASS III
122	12.40	149	N/A
150	13.98	173	N/A
165	15.75	250	N/A
182	18.25	337	373
200	20.00	423	467
222	22.25	505	555
245	24.50	681	748
270	27.00	810	944
300	30.00	997	1164
330	33.00	1200	1397
365	36.50	1506	1738
402	40.25	1936	2347
445	44.50	2363	2792
490	49.00	2939	3482

NOTE:
Weights do not include motor.

Performance Data

122 MPQN/MPQS

Wheel Diameter: 12.40"
Outlet Area: 2.40 ft²

Fan Efficiency Grade: FEG80
Max. BHP = 0.047 x (RPM / 1000)³

CFM	OV	1" SP		2" SP		3" SP		4" SP		5" SP		6" SP		7" SP		8" SP		9" SP		10" SP		12" SP	
		RPM	BHP	RPM	BHP	RPM	BHP	RPM	BHP	RPM	BHP	RPM	BHP	RPM	BHP	RPM	BHP	RPM	BHP	RPM	BHP	RPM	BHP
1000	417	1751	0.25	2146	0.46																		
1100	458	1838	0.28	2220	0.51																		
1200	500	1926	0.31	2297	0.57	2612	0.84																
1400	583	2113	0.39	2465	0.69	2760	0.99	3025	1.30														
1600	667	2313	0.49	2638	0.82	2921	1.15	3174	1.50	3405	1.85												
1800	750	2521	0.61	2818	0.96	3092	1.34	3333	1.72	3557	2.11	3765	2.51										
2000	833	2735	0.75	3009	1.13	3266	1.54	3503	1.96	3716	2.39												
2200	917	2954	0.91	3208	1.33	3447	1.77	3675	2.22														
2400	1000	3176	1.10	3413	1.55	3636	2.02																
2800	1167	3628	1.56																				
3200	1333																						
3600	1500																						

MAXIMUM RPM: CLASS II = 3800

150 MPQN/MPQS

Wheel Diameter: 13.98"
Outlet Area: 3.07 ft²

Fan Efficiency Grade: FEG75
Max. BHP = 0.087 x (RPM / 1000)³

CFM	OV	1" SP		2" SP		3" SP		4" SP		5" SP		6" SP		7" SP		8" SP		9" SP		10" SP		12" SP	
		RPM	BHP	RPM	BHP	RPM	BHP	RPM	BHP	RPM	BHP	RPM	BHP	RPM	BHP	RPM	BHP	RPM	BHP	RPM	BHP	RPM	BHP
1200	391	1502	0.29																				
1400	456	1621	0.35	1960	0.65																		
1600	521	1744	0.42	2068	0.76	2340	1.11																
1800	587	1875	0.51	2185	0.88	2445	1.27	2679	1.67														
2200	717	2156	0.72	2427	1.15	2674	1.62	2889	2.08	3091	2.57	3279	3.06										
2600	847	2450	0.99	2689	1.49	2914	2.02	3123	2.56	3310	3.11	3487	3.67	3656	4.25								
3000	978	2755	1.34	2969	1.90	3170	2.49	3364	3.10	3547	3.73	3715	4.36										
3400	1108	3066	1.77	3259	2.40	3442	3.05	3618	3.72	3789	4.42												
3800	1238	3382	2.30	3558	2.99	3726	3.71																
4200	1369																						
4600	1499																						
5000	1629																						

MAXIMUM RPM: CLASS II = 3800

Class II = First white section

Class III = Blue shaded section

Underlined figures indicate Maximum Static Efficiency

Performance certified is for installation Type A; Free inlet, Free outlet.

Power rating (BHP) does not include transmission losses.

Performance ratings do not include the effects of appurtenances (accessories).

Model MPQS is not licensed to bear the AMCA seal.

165 MPQN/MPQS

Wheel Diameter: 15.75"
Outlet Area: 3.88 ft²

Fan Efficiency Grade: FEG75
Max. BHP = 0.157 x (RPM / 1000)³

CFM	OV	1" SP		2" SP		3" SP		4" SP		5" SP		6" SP		7" SP		8" SP		9" SP		10" SP		12" SP	
		RPM	BHP	RPM	BHP	RPM	BHP	RPM	BHP	RPM	BHP	RPM	BHP	RPM	BHP	RPM	BHP	RPM	BHP	RPM	BHP	RPM	BHP
1500	386	1327	0.36																				
1700	438	1411	0.42	1715	0.79																		
1900	489	1496	0.49	1790	0.90	2041	1.32																
2100	541	1584	0.57	1869	1.01	2107	1.47																
2500	644	1774	0.75	2035	1.26	2259	1.79	2461	2.33	2648	2.90												
2900	747	1975	0.98	2209	1.55	2425	2.16	2614	2.77	2791	3.40	2954	4.04	3118	4.72								
3300	850	2183	1.26	2395	1.89	2594	2.56	2780	3.26	2946	3.95	3103	4.66	3253	5.39	3394	6.12						
3700	953	2396	1.60	2590	2.29	2773	3.03	2948	3.79	3112	4.57	3262	5.35	3404	6.14								
4500	1159	2834	2.49	3000	3.31	3157	4.17	3307	5.05	3454	5.96												
5300	1365			3425	4.65																		
6100	1571																						
6900	1777																						

MAXIMUM RPM: CLASS II = 3468

182 MPQN/MPQS

Wheel Diameter: 18.25"
Outlet Area: 5.21 ft²

Fan Efficiency Grade: FEG71
Max. BHP = 0.425 x (RPM / 1000)³

CFM	OV	1" SP		2" SP		3" SP		4" SP		5" SP		6" SP		7" SP		8" SP		9" SP		10" SP		12" SP	
		RPM	BHP	RPM	BHP	RPM	BHP	RPM	BHP	RPM	BHP	RPM	BHP	RPM	BHP	RPM	BHP	RPM	BHP	RPM	BHP	RPM	BHP
2500	480	1146	0.62	1413	1.19																		
2800	538	1217	0.72	1465	1.34	1692	2.02																
3100	595	1292	0.83	1524	1.49	1736	2.22																
3400	653	1370	0.96	1590	1.67	1788	2.43	1977	3.25														
4000	768	1530	1.26	1731	2.07	1911	2.92	2079	3.82	2241	4.77	2398	5.76										
4600	884	1697	1.62	1883	2.53	2047	3.48	2202	4.48	2349	5.50	2492	6.57	2631	7.69	2767	8.84						
5200	999	1868	2.07	2041	3.08	2195	4.13	2338	5.22	2475	6.35	2605	7.49	2733	8.68	2859	9.92	2980	11.17	3101	12.48		
5800	1114	2043	2.62	2204	3.72	2349	4.86	2483	6.04	2611	7.27	2734	8.53	2852	9.79	2967	11.09	3081	12.43	3194	13.83	3411	16.66
7000	1345	2399	4.01	2541	5.31	2670	6.65	2792	8.03	2907	9.44	3016	10.89	3121	12.36	3225	13.87	3325	15.38	3423	16.91	3614	20.06
8200	1575			2888	7.40	3005	8.93	3116	10.51	3221	12.11	3322	13.75	3418	15.40	3512	17.11	3602	18.81	3691	20.55		
9400	1806			3243	10.06	3350	11.79	3451	13.56	3547	15.35	3641	17.19	3731	19.05								
10600	2036			3604	13.38	3701	15.31																

MAXIMUM RPM: CLASS II = 2930 CLASS III = 3767

200 MPQN/MPQS

Wheel Diameter: 20.00"
Outlet Area: 6.25 ft²

Fan Efficiency Grade: FEG71
Max. BHP = 0.672 x (RPM / 1000)³

CFM	OV	1" SP		2" SP		3" SP		4" SP		5" SP		6" SP		7" SP		8" SP		9" SP		10" SP		12" SP	
		RPM	BHP	RPM	BHP	RPM	BHP	RPM	BHP	RPM	BHP	RPM	BHP	RPM	BHP	RPM	BHP	RPM	BHP	RPM	BHP	RPM	BHP
3000	480	1045	0.74	1289	1.43																		
3400	544	1117	0.88	1342	1.62	1548	2.45																
3800	608	1194	1.03	1403	1.84	1594	2.72	1776	3.67														
4200	672	1273	1.20	1471	2.08	1648	3.01	1817	4.01	1982	5.08												
4600	736	1354	1.40	1542	2.34	1710	3.33	1869	4.39	2021	5.50	2171	6.68										
5400	864	1522	1.87	1694	2.94	1846	4.06	1989	5.23	2125	6.45	2258	7.72	2386	9.04	2514	10.42						
6200	992	1695	2.46	1853	3.65	1994	4.90	2125	6.21	2250	7.54	2370	8.92	2488	10.35	2603	11.83	2714	13.32	2825	14.89		
7000	1120	1872	3.18	2018	4.50	2151	5.89	2273	7.32	2388	8.79	2500	10.29	2608	11.83	2713	13.40	2816	15.01	2919	16.69	3116	20.10
7800	1248	2051	4.05	2187	5.50	2312	7.02	2428	8.58	2536	10.17	2640	11.81	2741	13.48	2840	15.19	2935	16.90	3029	18.65	3214	22.29
9400	1504	2417	6.31	2536	8.03	2646	9.80	2750	11.62	2849	13.48	2943	15.37	3033	17.29	3120	19.25	3206	21.25	3290	23.27		
11000	1760			2894	11.38	2993	13.41	3087	15.49	3176	17.59	3263	19.75	3346	21.93	3427	24.15						
12600	2016			3259	15.67	3348	17.97	3434	20.31														

MAXIMUM RPM: CLASS II = 2674 CLASS III = 3438

222 MPQN/MPQS

Wheel Diameter: 22.25"
Outlet Area: 7.74 ft²

Fan Efficiency Grade: FEG71
Max. BHP = 1.146 x (RPM / 1000)³

CFM	OV	1" SP		2" SP		3" SP		4" SP		5" SP		6" SP		7" SP		8" SP		9" SP		10" SP		12" SP	
		RPM	BHP	RPM	BHP	RPM	BHP	RPM	BHP	RPM	BHP	RPM	BHP	RPM	BHP	RPM	BHP	RPM	BHP	RPM	BHP	RPM	BHP
3500	452	913	0.86	1141	1.68																		
4000	517	977	1.02	1185	1.90	1379	2.91																
4500	582	1045	1.20	1238	2.16	1415	3.22																
5000	646	1116	1.40	1297	2.45	1461	3.57	1617	4.79														
6000	776	1264	1.90	1427	3.11	1574	4.39	1711	5.73	1843	7.15	1971	8.63										
7000	905	1417	2.53	1568	3.90	1701	5.35	1826	6.85	1944	8.39	2060	10.01	2172	11.68	2281	13.41	2391	15.22				
8000	1034	1576	3.32	1714	4.85	1839	6.46	1953	8.12	2063	9.84	2168	11.58	2270	13.38	2370	15.24	2469	17.17	2564	19.12	2757	23.25
9000	1164	1737	4.28	1865	5.97	1982	7.74	2090	9.56	2191	11.44	2289	13.36	2384	15.32	2476	17.31	2566	19.34	2656	21.45	2829	25.77
10000	1293	1901	5.44	2020	7.29	2129	9.22	2232	11.21	2328	13.25	2419	15.33	2508	17.46	2595	19.62	2679	21.80	2761	24.01	2923	28.60
12000	1551	2234	8.44	2338	10.62	2436	12.88	2527	15.18	2614	17.54	2698	19.95	2777	22.37	2854	24.86	2930	27.40	3003	29.94		
14000	1810			2665	15.02	2752	17.60	2835	20.23	2914	22.91	2990	25.63	3064	28.39								
16000	2069			2997	20.64	3076	23.56																

MAXIMUM RPM: CLASS II = 2403 CLASS III = 3090

Class II = First white section

Class III = Blue shaded section

Underlined figures indicate Maximum Static Efficiency

Performance certified is for installation Type A; Free inlet, Free outlet.

Power rating (BHP) does not include transmission losses.

Performance ratings do not include the effects of appurtenances (accessories).

Model MPQS is not licensed to bear the AMCA seal.

245 MPQN/MPQS

Wheel Diameter: 24.50"
Outlet Area: 9.38 ft²

Fan Efficiency Grade: FEG71
Max. BHP = 1.926 x (RPM / 1000)³

CFM	OV	1" SP		2" SP		3" SP		4" SP		5" SP		6" SP		7" SP		8" SP		9" SP		10" SP		12" SP	
		RPM	BHP	RPM	BHP	RPM	BHP	RPM	BHP	RPM	BHP	RPM	BHP	RPM	BHP	RPM	BHP	RPM	BHP	RPM	BHP	RPM	BHP
4400	469	813	1.02																				
5000	533	866	1.21	<u>1059</u>	<u>2.28</u>																		
5600	597	923	1.41	<u>1101</u>	<u>2.57</u>	<u>1264</u>	<u>3.83</u>																
6200	661	983	1.64	1148	2.89	1302	4.24																
7400	789	1110	2.20	1255	3.63	1391	5.15	<u>1520</u>	<u>6.76</u>	<u>1640</u>	<u>8.42</u>												
8600	917	1244	2.90	1373	4.51	1494	6.21	1610	7.98	<u>1723</u>	<u>9.85</u>	1829	11.76	1933	13.73								
9800	1045	1381	3.76	1498	5.57	1608	7.44	1713	9.39	1815	11.41	1915	13.51	<u>2011</u>	<u>15.65</u>	<u>2103</u>	<u>17.86</u>	<u>2194</u>	<u>20.10</u>				
11000	1173	1519	4.80	1629	6.80	1729	8.87	1826	11.00	1919	13.19	2011	15.46	<u>2100</u>	<u>17.77</u>	<u>2188</u>	<u>20.16</u>	<u>2273</u>	<u>22.60</u>	<u>2354</u>	<u>25.05</u>		
12200	1301	1658	6.04	1764	8.26	1856	10.51	1945	12.82	2032	15.20	2116	17.62	2199	20.12	2280	22.66	2360	25.26	2439	27.93	2589	33.35
14600	1557	1938	9.19	2039	11.88	2122	14.52	2199	17.22	2274	19.96	2348	22.74	2420	25.57	2491	28.47	2560	31.39	2629	34.38	2765	40.51
17000	1813			2315	16.52	2396	19.64	2466	22.71	2533	25.84	2597	28.99	2662	32.21	2726	35.48	2788	38.76				
19400	2068			2595	22.41	2671	25.95	2740	29.50	2802	33.02												

MAXIMUM RPM: CLASS II = 2183 CLASS III = 2806

270 MPQN/MPQS

Wheel Diameter: 27.00"
Outlet Area: 11.39 ft²

Fan Efficiency Grade: FEG71
Max. BHP = 3.131 x (RPM / 1000)³

CFM	OV	1" SP		2" SP		3" SP		4" SP		5" SP		6" SP		7" SP		8" SP		9" SP		10" SP		12" SP	
		RPM	BHP	RPM	BHP	RPM	BHP	RPM	BHP	RPM	BHP	RPM	BHP	RPM	BHP	RPM	BHP	RPM	BHP	RPM	BHP	RPM	BHP
5000	439	717	1.15																				
5800	509	767	1.38	<u>947</u>	<u>2.64</u>																		
6600	579	823	1.64	988	3.02																		
7400	650	882	1.94	1034	3.44	1174	5.05																
8200	720	944	2.29	1085	3.90	<u>1217</u>	<u>5.64</u>	<u>1339</u>	<u>7.47</u>														
9000	790	1008	2.68	1139	4.40	1263	6.27	<u>1380</u>	<u>8.22</u>	1489	10.25												
10600	931	1142	3.62	1258	5.61	1366	7.68	1471	9.88	<u>1572</u>	<u>12.15</u>	1668	14.50	1760	16.91								
12200	1071	1279	4.81	1383	7.05	1481	9.37	1575	11.79	1666	14.29	1755	16.88	<u>1841</u>	<u>19.53</u>	<u>1924</u>	<u>22.25</u>	<u>2003</u>	<u>24.99</u>				
13800	1211	1416	6.26	1515	8.77	1603	11.34	1689	14.00	1772	16.73	1852	19.52	1932	22.42	2010	25.38	<u>2086</u>	<u>28.41</u>	<u>2159</u>	<u>31.46</u>	<u>2301</u>	<u>37.73</u>
17000	1492	1695	10.10	1787	13.20	1864	16.29	1936	19.45	2007	22.67	2076	25.94	2143	29.25	2210	32.69	2275	36.14	2340	39.68	2467	46.92
20200	1773	1977	15.39	2062	19.11	2136	22.81	2200	26.46	2261	30.17	2321	33.95	2381	37.79	2440	41.69	2497	45.60				
23400	2054			2340	26.76	2410	31.06	2472	35.31	2529	39.58												

MAXIMUM RPM: CLASS II = 1981 CLASS III = 2546

300 MPQN/MPQS

Wheel Diameter: 30.00"
Outlet Area: 14.06 ft²

Fan Efficiency Grade: FEG71
Max. BHP = 5.296 x (RPM / 1000)³

CFM	OV	1" SP		2" SP		3" SP		4" SP		5" SP		6" SP		7" SP		8" SP		9" SP		10" SP		12" SP	
		RPM	BHP	RPM	BHP	RPM	BHP	RPM	BHP	RPM	BHP	RPM	BHP	RPM	BHP	RPM	BHP	RPM	BHP	RPM	BHP	RPM	BHP
6000	427	639	1.38																				
7000	498	683	1.66	<u>847</u>	<u>3.19</u>																		
8000	569	733	1.98	884	3.66																		
9000	640	786	2.34	925	4.17	1052	6.15																
10000	711	842	2.77	970	4.73	<u>1090</u>	<u>6.86</u>	<u>1201</u>	<u>9.12</u>														
11000	782	901	3.25	1020	5.37	1132	7.65	1238	10.05	1337	12.54												
13000	924	1023	4.42	1127	6.85	1225	9.40	1320	12.10	1411	14.89	1498	17.79	1581	20.72								
15000	1067	1147	5.89	1241	8.64	1330	11.51	1414	14.46	1496	17.53	1577	20.74	1654	23.98	1729	27.35	<u>1801</u>	<u>30.75</u>				
17000	1209	1272	7.69	1361	10.78	1441	13.96	1518	17.22	1593	20.60	1665	24.03	1737	27.60	1807	31.24	1876	34.99	1942	38.77	2070	46.50
21000	1493	1526	12.48	1609	16.31	1678	20.13	1743	24.03	1807	28.01	1869	32.05	1930	36.18	1989	40.35	2048	44.64	2106	48.99	2221	57.98
25000	1778	1783	19.11	1860	23.73	1926	28.29	1984	32.83	2039	37.43	2093	42.11	2146	46.81	2199	51.64	2251	56.53				
29000	2062			2113	33.33	2176	38.67	2232	43.95	2283	49.23												

MAXIMUM RPM: CLASS II = 1783 CLASS III = 2291

330 MPQN/MPQS

Wheel Diameter: 33.00"
Outlet Area: 17.02 ft²

Fan Efficiency Grade: FEG71
Max. BHP = 8.539 x (RPM / 1000)³

CFM	OV	1" SP		2" SP		3" SP		4" SP		5" SP		6" SP		7" SP		8" SP		9" SP		10" SP		12" SP	
		RPM	BHP	RPM	BHP	RPM	BHP	RPM	BHP	RPM	BHP	RPM	BHP	RPM	BHP	RPM	BHP	RPM	BHP	RPM	BHP	RPM	BHP
7000	411	573	1.61																				
8000	470	604	1.86																				
9000	529	640	2.16	<u>784</u>	<u>4.10</u>																		
11000	646	719	2.88	844	5.10	959	7.51																
13000	764	805	3.77	915	6.29	1019	9.00	<u>1116</u>	<u>11.85</u>														
15000	882	896	4.89	994	7.70	1087	10.70	1176	13.84	<u>1261</u>	<u>17.11</u>	<u>1341</u>	<u>20.48</u>										
17000	999	989	6.24	1078	9.37	1163	12.67	1243	16.06	1322	19.64	<u>1398</u>	<u>23.32</u>	<u>1471</u>	<u>27.12</u>	<u>1541</u>	<u>30.98</u>						
19000	1117	1083	7.85	1166	11.31	1244	14.92	1318	18.62	1390	22.46	1461	26.46	1529	30.49	1596	34.69	<u>1660</u>	<u>38.95</u>	<u>1723</u>	<u>43.30</u>		
23000	1352	1272	11.96	1350	16.15	1416	20.35	1481	24.72	1543	29.13	1604	33.67	1663	38.28	1722	43.05	1780	47.91	1837	52.85	1947	62.96
27000	1587	1464	17.48	1538	22.44	1599	27.32	1655	32.26	1710	37.33	1764	42.46	1817	47.69	1869	53.02	1920	58.42	1970	63.89	2070	75.21
31000	1822			1726	30.31	1786	35.99	1838	41.59	1887	47.26	1935	53.04	1983	58.92	2030	64.84	2076	70.82				
35000	2057			1917	40.11	1974	46.53	2025	52.91	2071	59.25												

MAXIMUM RPM: CLASS II = 1620 CLASS III = 2083

Class II = First white section
 Class III = Blue shaded section
 Underlined figures indicate Maximum Static Efficiency

Performance certified is for installation Type A; Free inlet, Free outlet.
 Power rating (BHP) does not include transmission losses.
 Performance ratings do not include the effects of appurtenances (accessories).
 Model MPQS is not licensed to bear the AMCA seal.

365 MPQN/MPQS

Wheel Diameter: 36.50"
Outlet Area: 20.82 ft²

Fan Efficiency Grade: FEG75
Max. BHP = 14.43 x (RPM / 1000)³

CFM	OV	1" SP		2" SP		3" SP		4" SP		5" SP		6" SP		7" SP		8" SP		9" SP		10" SP		12" SP	
		RPM	BHP	RPM	BHP	RPM	BHP	RPM	BHP	RPM	BHP	RPM	BHP	RPM	BHP	RPM	BHP	RPM	BHP	RPM	BHP	RPM	BHP
8000	384	499	1.79																				
9200	442	528	2.11																				
10400	500	559	2.45	685	4.64																		
11600	557	594	2.87	712	5.20																		
14000	673	667	3.83	772	6.52	868	9.43																
16400	788	745	5.04	840	8.11	926	11.33	1007	14.72	1082	18.27												
18800	903	826	6.53	912	9.97	991	13.54	1065	17.25	1137	21.17	1204	25.17	1269	29.36								
23800	1143	1000	10.69	1073	14.91	1141	19.32	1205	23.78	1266	28.34	1325	33.06	1383	37.96	1439	42.92	1493	47.96	1544	53.11		
28400	1364	1166	16.12	1230	21.04	1290	26.17	1347	31.42	1401	36.68	1454	42.07	1505	47.53	1555	53.14	1603	58.77	1651	64.59	1745	76.58
33200	1595			1398	29.34	1452	35.20	1503	41.19	1552	47.29	1600	53.52	1646	59.70	1691	65.97	1735	72.32	1778	78.75	1862	91.95
38000	1826			1570	39.95	1619	46.57	1665	53.24	1710	60.13	1753	67.05	1795	74.06	1837	81.23	1877	88.28				
42800	2056			1745	53.20	1789	60.54	1831	67.93	1872	75.47												

MAXIMUM RPM: CLASS II = 1465 CLASS III = 1884

402 MPQN/MPQS

Wheel Diameter: 40.25"
Outlet Area: 25.31 ft²

Fan Efficiency Grade: FEG75
Max. BHP = 23.54 x (RPM / 1000)³

CFM	OV	1" SP		2" SP		3" SP		4" SP		5" SP		6" SP		7" SP		8" SP		9" SP		10" SP		12" SP	
		RPM	BHP	RPM	BHP	RPM	BHP	RPM	BHP	RPM	BHP	RPM	BHP	RPM	BHP	RPM	BHP	RPM	BHP	RPM	BHP	RPM	BHP
10000	395	457	2.24																				
11500	454	484	2.64																				
13000	514	515	3.11	627	5.80																		
16000	632	581	4.22	680	7.33	769	10.70																
19000	751	652	5.61	741	9.19	822	12.99	898	17.02														
22000	869	727	7.36	807	11.41	881	15.64	950	20.05	1016	24.65	1077	29.39										
25000	988	804	9.51	877	14.02	945	18.72	1009	23.57	1070	28.60	1129	33.81	1185	39.12	1238	44.59						
28000	1106	882	12.09	950	17.09	1013	22.29	1072	27.55	1129	33.01	1183	38.56	1237	44.40	1289	50.33	1338	56.34	1385	62.45		
34000	1343	1043	18.90	1102	24.82	1156	30.89	1209	37.25	1259	43.61	1307	50.03	1354	56.63	1399	63.28	1444	70.19	1488	77.20	1573	91.47
40000	1580			1258	34.97	1307	42.00	1354	49.28	1398	56.56	1442	64.08	1484	71.55	1525	79.10	1565	86.74	1605	94.63	1681	110.47
46000	1817			1418	48.05	1462	56.01	1505	64.23	1545	72.44	1585	80.95	1623	89.41	1661	98.06	1697	106.54				
52000	2054			1581	64.53	1621	73.46	1659	82.42	1697	91.71												

MAXIMUM RPM: CLASS II = 1329 CLASS III = 1708

445 MPQN/MPQS

Wheel Diameter: 44.50"
Outlet Area: 30.94 ft²

Fan Efficiency Grade: FEG75
Max. BHP = 38.85 x (RPM / 1000)³

CFM	OV	1" SP		2" SP		3" SP		4" SP		5" SP		6" SP		7" SP		8" SP		9" SP		10" SP		12" SP	
		RPM	BHP	RPM	BHP	RPM	BHP	RPM	BHP	RPM	BHP	RPM	BHP	RPM	BHP	RPM	BHP	RPM	BHP	RPM	BHP	RPM	BHP
12000	388	411	2.70																				
13800	446	435	3.17																				
15600	504	461	3.70	564	6.97																		
17400	562	490	4.33	586	7.81																		
21000	679	550	5.77	636	9.80	714	14.13																
24600	795	615	7.61	692	12.19	763	17.05	829	22.11	890	27.39												
28200	911	682	9.86	752	15.02	817	20.39	878	26.01	936	31.81	991	37.80	1043	43.98								
35400	1144	821	15.94	881	22.22	936	28.72	989	35.41	1039	42.20	1087	49.17	1134	56.36	1180	63.75	1225	71.36	1267	79.05		
42600	1377	964	24.49	1016	31.85	1065	39.52	1111	47.34	1156	55.35	1199	63.40	1240	71.46	1281	79.89	1321	88.48	1360	97.16	1436	114.94
49800	1610			1156	44.56	1199	53.21	1241	62.24	1281	71.39	1320	80.69	1358	90.07	1394	99.31	1430	108.83	1465	118.43	1534	138.30
57000	1842			1298	60.66	1338	70.60	1375	80.51	1412	90.87	1447	101.23	1482	111.9	1515	122.36						
64200	2075			1443	80.86	1479	91.89	1513	102.92														

MAXIMUM RPM: CLASS II = 1202 CLASS III = 1545

490 MPQN/MPQS

Wheel Diameter: 49.00"
Outlet Area: 37.52 ft²

Fan Efficiency Grade: FEG75
Max. BHP = 62.95 x (RPM / 1000)³

CFM	OV	1" SP		2" SP		3" SP		4" SP		5" SP		6" SP		7" SP		8" SP		9" SP		10" SP		12" SP	
		RPM	BHP	RPM	BHP	RPM	BHP	RPM	BHP	RPM	BHP	RPM	BHP	RPM	BHP	RPM	BHP	RPM	BHP	RPM	BHP	RPM	BHP
16000	426	387	3.63																				
18000	480	408	4.19																				
20000	533	431	4.83	522	8.94																		
24000	640	481	6.38	562	11.05	635	16.10																
28000	746	534	8.26	607	13.53	673	19.08	736	25.06														
32000	853	589	10.54	656	16.48	717	22.63	774	29.04	829	35.80	880	42.82										
36000	960	645	13.26	707	19.85	764	26.65	817	33.64	868	40.94	917	48.46										
44000	1173	761	20.39	815	28.21	864	36.25	911	44.49	956	52.92	999	61.52	1041	70.41	1082	79.48	1123	89.00	1161	98.40		
52000	1386	881	30.20	928	39.19	972	48.51	1014	58.12	1054	67.77	1093	77.60	1131	87.65	1167	97.65	1203	108.07	1238	118.56	1307	140.27
60000	1599			1044	53.24	1084	63.80	1122	74.64	1158	85.57	1194	96.88	1228	108.01	1262	119.48	1294	130.73	1326	142.34	1389	166.37
68000	1813			1162	70.76	1199	82.68	1233	94.53	1267	106.93	1299	119.27	1331	131.99	1362	144.69	1392	157.35				
76000	2026			1283	92.53	1316	105.54	1348	118.77	1379	132.25												

MAXIMUM RPM: CLASS II = 1091 CLASS III = 1403

Class II = First white section
Class III = Blue shaded section
Underlined figures indicate Maximum Static Efficiency

Performance certified for installation Type A; Free inlet, Free outlet.
Power rating (BHP) does not include transmission losses.
Performance ratings do not include the effects of appurtenances (accessories).
Model MPQS is not licensed to bear the AMCA seal.

Horizontal, Arr. 4 - Class II

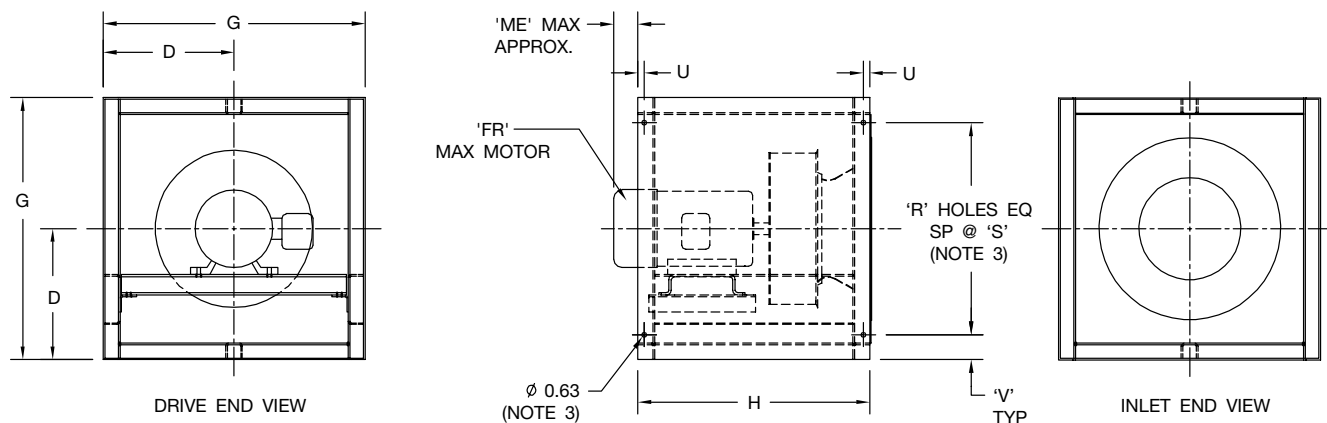

NOTES:

- Horizontal application only.
- CW rotation is standard, CCW rotation is optional. Rotation is determined by viewing the drive end.
- Mounting hole pattern typical on inlet and drive end on all four sides. 3/8" diameter mounting hardware suggested. See IOM-110 for fan installation instructions.
- Model MPQN provides acoustically insulated housing with perforated plate separating insulation from airstream. Model MPQS is identical to MPQN with the exception of the acoustical insulation and perforated plate.

SIZE	G	D	H	'R' PER SIDE	S	U	V	'ME' MAX REF	MAX 'FR'
122	23.00	11.50	20.00	2	16.81	1.13	3.13	2.25	184T
150	25.38	12.69	21.00	2	19.19	1.13	3.13	6.25	213T
165	28.06	14.06	23.63	3	10.94	1.13	3.13	4.81	215T
182	31.81	15.94	27.38	3	12.75	1.13	3.13	8.56	254T
200	34.50	17.25	30.00	3	14.13	1.13	3.13	7.19	254T
222	39.81	19.94	33.38	3	17.81	1.75	2.13	5.44	256T
245	43.25	21.63	36.75	3	19.50	1.75	2.13	6.84	284T
270	46.94	23.50	40.50	4	14.25	1.75	2.13	5.00	286T
300	51.50	25.75	45.00	4	15.75	1.75	2.13	5.50	324T
330	55.94	28.00	49.50	4	17.25	1.75	2.13	3.25	326T
365	61.25	30.63	54.75	5	14.25	2.25	2.13	5.69	405T
402	68.81	34.44	60.38	5	15.63	2.25	3.13	3.13	405T
445	75.25	37.63	66.75	5	17.25	2.25	3.13	0.13	405T
490	81.94	41.00	73.50	5	18.94	2.25	3.13	1.38	444T

BC1003160E

DIMENSIONS ARE SUBJECT TO CHANGE. CERTIFIED DRAWINGS AVAILABLE UPON REQUEST.

Fans shall be Model MPQN or MPQS centrifugal plenum (plug) type, as manufactured by Twin City Fan & Blower, Minneapolis, Minnesota.

PERFORMANCE — Fans shall be tested in accordance with ANSI/AMCA Standard 210 (air performance) and 300 (sound performance) in an AMCA accredited laboratory. Performance ratings (MPQN only) shall conform to AMCA Standard 205 (fan efficiency grade), Publication 211 (air performance) and Publication 311 (sound performance). Fans (MPQN only) shall be licensed to bear the AMCA certified ratings seal for both sound and air, and fan efficiency grade (FEG). Sound certification shall apply to both inlet and outlet sound power levels.

Fans shall have a sharply rising pressure characteristic extending through the operating range and continuing to rise beyond the peak efficiency to ensure quiet and stable operation. Fans shall have a non-overloading design with self-limiting horsepower characteristics and shall reach a peak in the normal selection area. All fans shall be capable of operating over the minimum pressure class limits as specified in AMCA Standard 99.

CONSTRUCTION — Fans shall be designed without a scroll type housing and shall incorporate a non-overloading type backward inclined airfoil blade wheel, heavy-gauge reinforced steel inlet plate and structural steel frame.

INSULATION (MPQN Only) — Fans shall be provided with minimum 2" insulation enclosure with perforated lining.

FRAME AND INLET PANEL — Inlet panels shall be of heavy-gauge reinforced steel construction. The inlet panel incorporates a removable spun inlet cone designed for smooth airflow into the accompanying inlet retaining ring of the fan wheel. A square, formed lip suitable for attachment of a boot connector shall surround the unit.

WHEEL — Wheels shall have a spun non-tapered style blade retaining ring on the inlet side to allow higher efficiencies over the performance range of the fan. Wheels shall have airfoil-shaped extruded aluminum blades. All hollow blade wheels shall be continuously welded around all edges. Wheels shall have twelve blades for better sound quality. All wheels shall be statically and dynamically balanced on precision electronic balancers to a Balance Quality Grade G6.3 per ANSI/AMCA 204 or better.

FINISH AND COATING — The entire fan assembly shall be thoroughly degreased and deburred before application of a rust-preventative coating. Aluminum components shall be unpainted.

FACTORY RUN TEST — All fans prior to shipment shall be completely assembled and test run as a unit at the specified operating speed or maximum RPM allowed for the particular construction type. Maximum vibration shall be within the limits of ANSI/AMCA 204 Fan Application Category BV-4. Balance readings shall be taken by electronic type equipment in the axial, vertical, and horizontal directions on each of the bearings. Records shall be maintained and a written copy shall be available upon request.

GUARANTEE — The manufacturer shall guarantee the workmanship and materials for its MPQN fans for at least one (1) year from startup or eighteen (18) months from shipment, whichever occurs first.



INDUSTRIAL & COMMERCIAL FANS

Centrifugal Fans | Utility Sets | Plenum & Plug Fans | Inline Centrifugal Fans
Mixed Flow Fans | Tubeaxial & Vaneaxial Fans | Propeller Wall Fans | Propeller Roof Ventilators
Centrifugal Roof & Wall Exhausters | Ceiling Ventilators | Gravity Ventilators | Duct Blowers
Radial Bladed Fans | Radial Tip Fans | High Efficiency Industrial Fans | Pressure Blowers
Laboratory Exhaust Fans | Filtered Supply Fans | Mancoolers | Fiberglass Fans | Custom Fans



A Twin City Fan Company

TWIN CITY FAN & BLOWER | WWW.TCF.COM

5959 Trenton Lane N | Minneapolis, MN 55442 | Phone: 763-551-7600 | Fax: 763-551-7601