

Axial Flow Fans

- Direct Driven
- Belt Driven



A09-TH

Wolter Ventilation Co., LTD. certifies that the series AXV shown herein are licensed to bear the AMCA Seal. The ratings shown are based on tests and procedures performed in accordance with AMCA Publication 211 and AMCA Publication 311 and comply with the requirements of the AMCA Certified Ratings Program.



Contents	Page 1
Fan Type Code	Page 2
Design Features	Page 2
Fan Selection and Installation	Page 4
Selection Sample	Page 4
AMCA FEG Rating	Page 5
Fan Performance Curves - 50Hz	Page 6~26
AMCA FEG Rating	Page 27
Fan Performance Curves - 60Hz	Page 28~48
Dimensions	Page 49~51
Accessories	Page 52
Sound Information	Page 53~55
Tubular sound attenuator for AXV	Page 56~57

Subject to change without prior notice.

Axial Flow Fans

Technical information

AXV

Fan type code

AXV	450-26°	LH100	-2	AL	SU	400°C/2Std
						Smoke extract fan 400°C/120min, 300°C/120min
						Air flow and form of running S, D, SU, SO, DU, DO
						Material of blade
						number of poles
						Casing version SH = Short-cased LH1 = Long-cased
						Pitch angle
						AXV: impeller-ø 355...2800
						Axial impeller blade type



Design features

Types and duty range

Wolter Axial flow fans can be used for various applications in ventilation and process air technology. Standard diameters range from 355 to 2800mm, with airflow rates of up to 290 m³/s at static pressure increases of up to 1600 Pa. Higher pressures can be achieved by using contra-rotating multi-stage fans.

Belt driven fans are designed for application that required motor to be isolated from the airstreams.

Smoke spill operation

The AXV range of axial fans is designed and tested to operate at standard temperatures as well as at elevated temperatures of 300°C for 60 (F300) and 120 minutes and 400°C for at least 120 minutes (F400), according to DIN EN ISO 12101, part 3. The following fan curves are valid for standard temperatures and 300°/ 60 (F300) and 120 minutes operation. To select a fan for 400°C/120 minutes operation, please contact our technical support.

Casing

Fan casings are of hot-dip galvanized finishing. Flanges are rolled, the pitch circles of holes are in accordance with DIN 24 154, R2.

- › LH - Long-cased axial fan, with external terminal box
- › SH - Short-cased axial fan

If motors require additional lubrication, tubes and grease-nipples are fitted to the outside of the fan casing. An inspection hole, closed by a rubber plug, allows technical personnel to view the direction of impeller rotation.

Impellers

AXV impellers, hubs and blades are made off pressure-cast aluminium alloy, the aerodynamic profile guarantees high efficiency and low noise levels. The blade pitch angle is adjustable during standstill. The variable number of blades the expands the performance range.

Motor

Wolter uses closed squirrel cage motors according to IEC 34, if required also in accordance with EPACT. Standard motors are class F with IP 55 protection class. Multi speed versions with 2 or 3 speeds (Dahlander circuit or separate windings) are also available, as well as explosion-proof versions or specific industrial executions such as marine-type fans. The motor bearings have a L 10 life.

Forms of running

Wolter AXV axial flow fans are available for all forms of running. The right chart shows all standard forms of running. Please indicate the required configuration when ordering. Without specific instructions, fans will be delivered in configuration S. Arrows outside the fan casing indicates the correct direction of rotation and airflow.

Form D, DU and DO are not licensed by AMCA International.

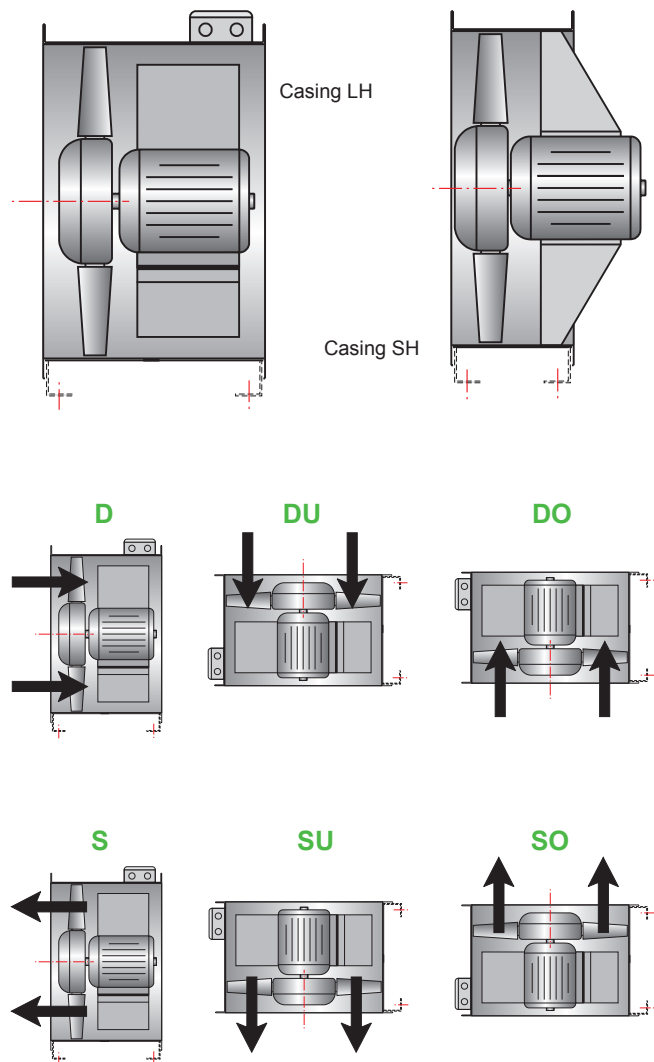



AXV DD



AXV BD



Fan performance curves

The performance curves for these fan types have been established in mounting position D (according to AMCA 210, duct connected to inlet and outlet sides) and represent the total pressure increase Δp_t as a function of the volume flow. The dynamic pressure p_{d2} is related to the flange cross-sectional area at the of the fan.

Sound levels

The ascertaining of the sound level follows the Reverberant Room Method in accordance to AMCA 300. The A-weighted sound power levels is shown on the performance curves.

Belt driven design

Belt driven fan with single / dual motors can be mounted in various positions

to suit the actual site condition. Belt driven fans are used for applications to extract more heavily polluted air i.e. presence of corrosive or hazardous fumes, or dirt-laden, moist air or hot air from professional kitchens. Various mounting positions are illustrated.

Ordering designations

When ordering, please provide the following information:

- › fan type code (see above), casing version and form of running
- › duty required at standard air temperature (air volume in m³/h at static pressure in Pa)
- › motor power rating in kW
- › electrical supply
- › required ancillary equipment

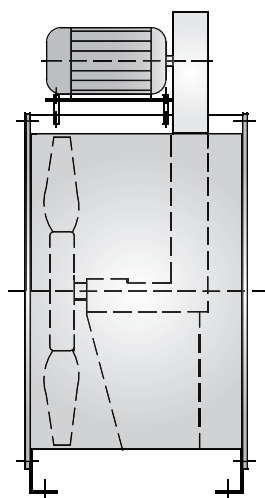

Motor Mounting at Zero Position

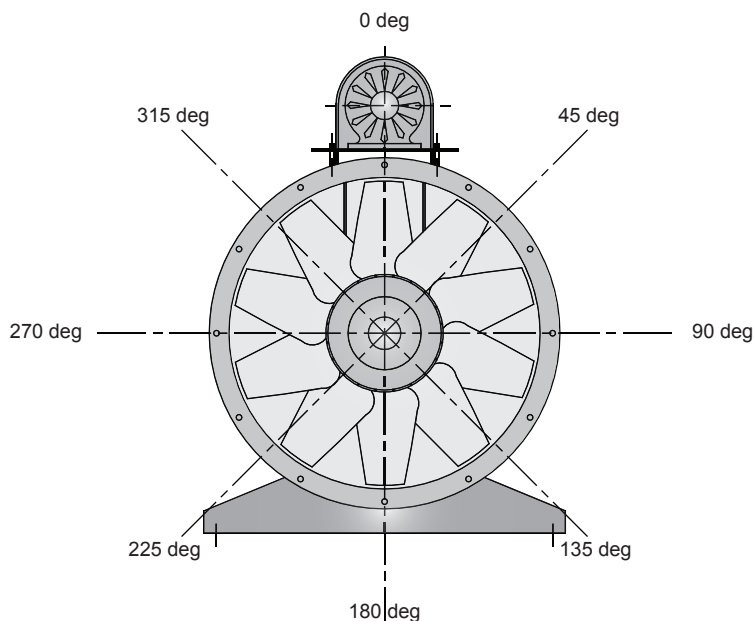

Motor Mounting Position - Specify in degree

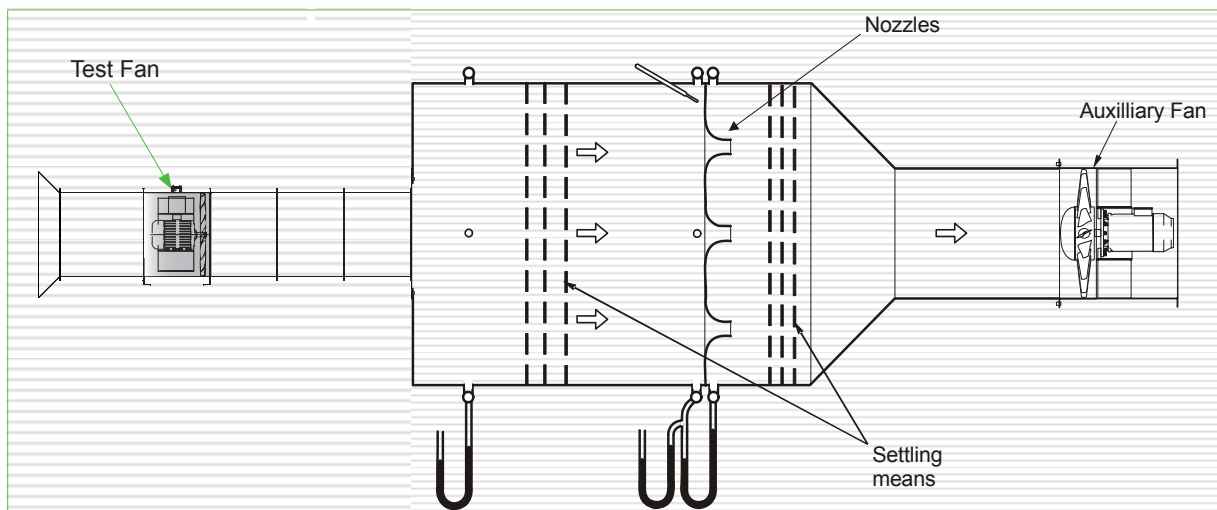

AMCA 210 Figure 12
ISO 5801 Figure 73b

Axial Flow Fans

Technical information

AXV

Fan selection and installation

Fan selection

Please select fans according to the nearest performance curve above the required duty point. The middle range of each fan curve is the area of highest efficiency. Do not select fans at the upper end of the fan curve, as this might cause the fan to work in stall. In order to avoid motor overloading, please select motors according to the peak power of the respective performance curve. Please refer to the selection example on the following page.

Fan installation

When installing the fan, please consider the following instructions:

► Fans with free inlet and outlet should be installed with an unobstructed distance of at least 1,5 x fan diameter on suction and pressure sides. Fans should have a bellmouth on the inlet side in order to assure optimal incoming flow. A diffusor mounted on the pressure side will increase efficiency.

► When installing fans in a ducted system, adequate distance to other structural parts such as bends, filters and silencers should be provided for. A sharp bend radius of the duct near the suction or pressure side of the fan is to be avoided. Flexible connections are to be installed in a way that does not obstruct the outlet cross section of the fan (see following page).

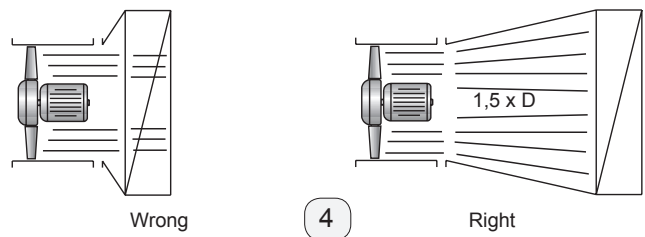
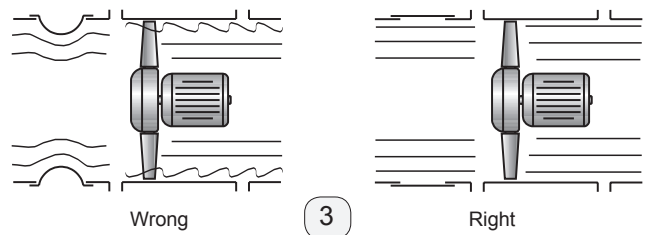
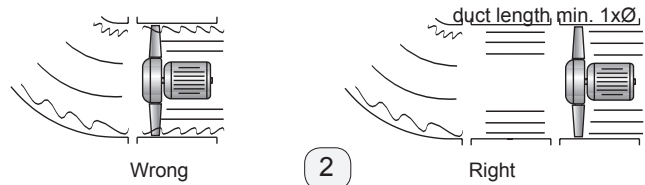
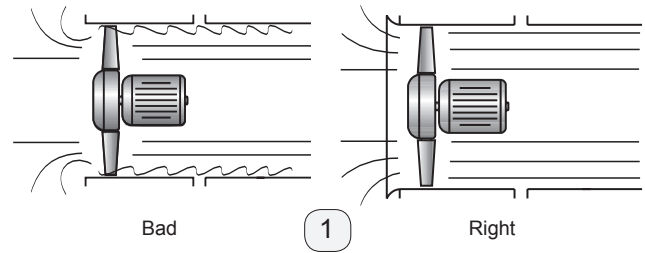

Selection example

Required duty point

- > Volume flow : 5.000 m³/h
- > Static pressure: 110 Pa

In order to calculate the total pressure, please add velocity pressure to static pressure (30 Pa dynamic pressure + 110 Pa static pressure = 140 Pa total pressure)

- > Fan speed: 1.440 1/min (4-pole)

Using the fan curve

Having chosen a fan with adequate performance range for the required duty point, plot volume flow and pressure.

At the point of intersection, the following data can be read:

- > Motor speed or number of poles 1.440 1/min - 4-pole
- > Pitch angle: 18 degrees
- > FEG Rating: FEG71 (see page5)
- > Inlet sound power level: 80 dB(A)

Calculation of motor power:

There are two possibilities to calculate the motor power:

- 1) Calculation of absorbed power by using the fan curve in duty point: 0,338 kW

Motor power: 0,37 kW

- 2) Calculation according to peak absorbed power, see table below the fan curve: 0,366 kW

Motor power: 0,37 kW

The given peak absorbed power is the maximum shaft absorbed power over the whole pitch angle in.

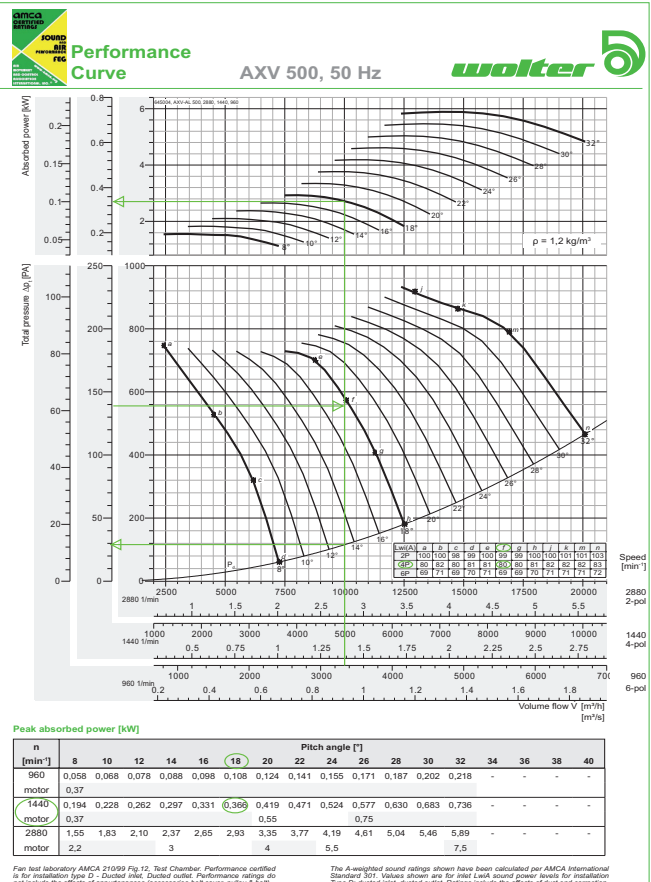

AMCA - FEG rating

Fan Efficiency Grade - AXV



Certified FEGs are determined in accordance with AMCA 205-12 Energy Efficiency Classification for fans. In conjunction with AMCA 211-13 (Rev. 2015) Certified Ratings Program, Product Rating Manual for Fan Air Performance. This classification is based on fan peak (optimum) total efficiency for a given fan speed, fan size and application category. For the purpose of energy classification, the peak efficiency can be determined at a speed not higher than the maximum design speed of the fan.

The AMCA Certified Ratings Seal applies to the Fan Efficiency Grade (FEG) for AXV series Axial Fan model AXV 355 to AXV 2800 as shown in the table below.

Fan Model No.	Fan Speed (rpm)	Fan Outlet Area (m ²)	Fan Efficiency Grades (FEG)	Fan Model No.	Fan Speed (rpm)	Fan Outlet Area (m ²)	Fan Efficiency Grade (FEG)
AXV 355	2880/1440/960	0,1012	FEG63	AXV 1250	1440/960/720	1,2272	FEG71
AXV 400	2880/1440/960	0,1269	FEG67	AXV 1400	960/720/576	1,5504	FEG75
AXV 450	2880/1440/960	0,1590	FEG63	AXV 1600	960/720/576	1,9981	FEG67
AXV 500	2880/1440/960	0,2003	FEG71	AXV 1800	960/720/576	2,5588	FEG75
AXV 560	2880/1440/960	0,2516	FEG67	AXV 2000	960/720/576	3,1573	FEG75
AXV 630	2880/1440/960	0,3167	FEG63	AXV 2200	720/576/480	3,8186	FEG75
AXV 710	1440/960/720	0,3982	FEG67	AXV 2400	720/576/480	4,5428	FEG75
AXV 800	1440/960/720	0,5001	FEG67	AXV 2500	720/576/480	4,9284	FEG75
AXV 900	1440/960/720	0,6333	FEG63	AXV 2600	720/576/480	5,3297	FEG75
AXV 1000	1440/960/720	0,7980	FEG71	AXV 2800	720/576/480	6,1795	FEG75
AXV 1120	1440/960/720	0,9978	FEG71				

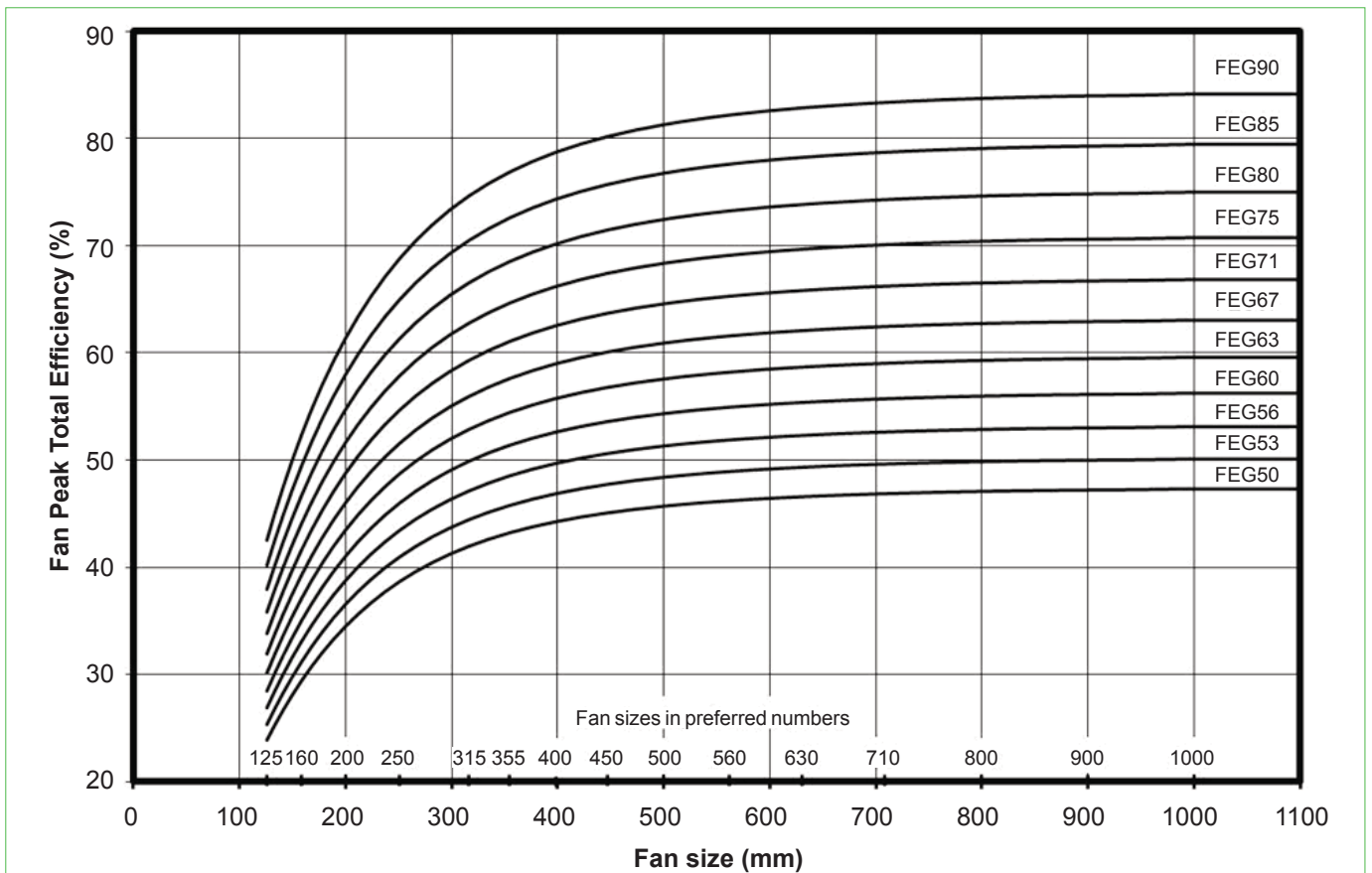

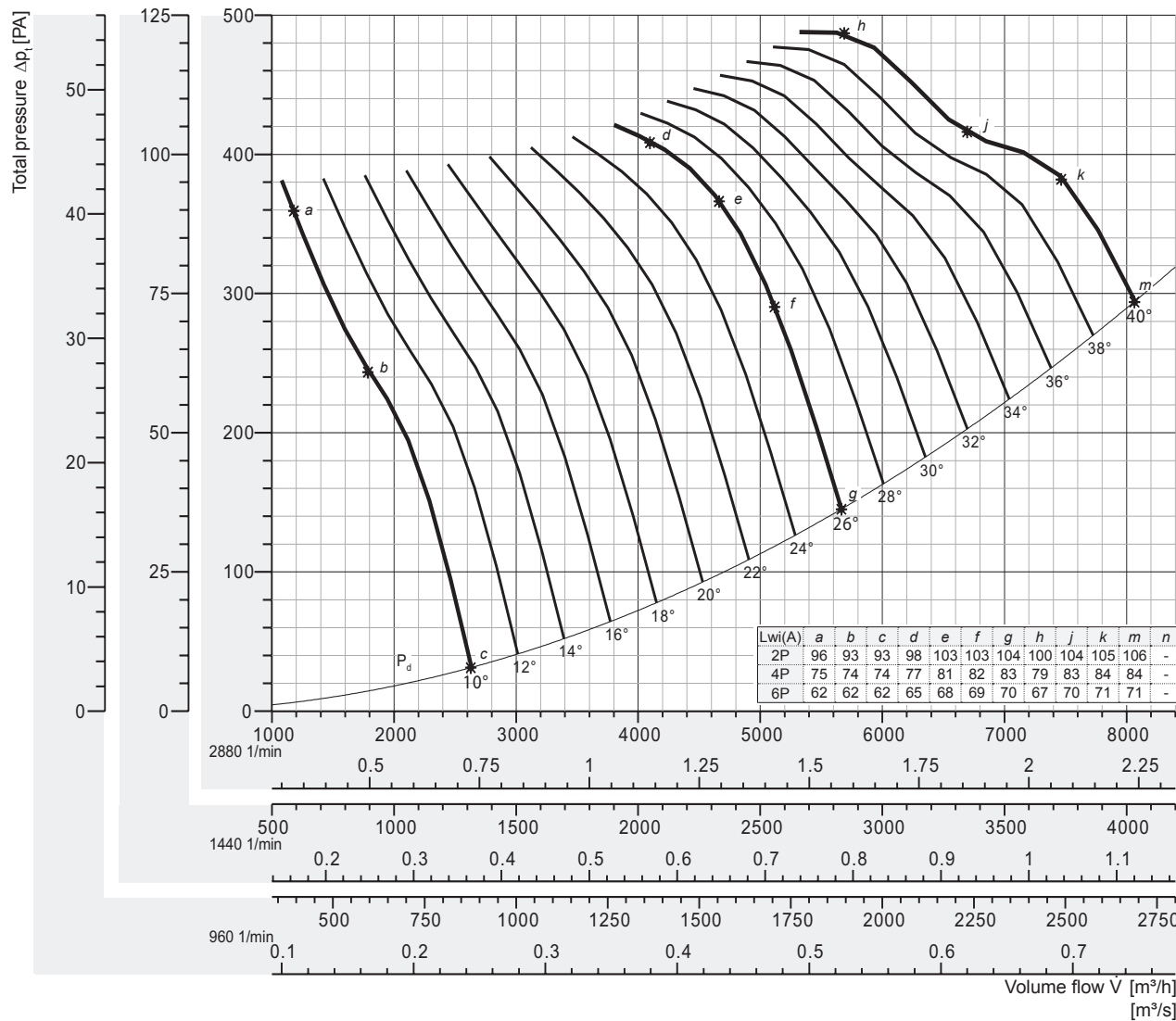
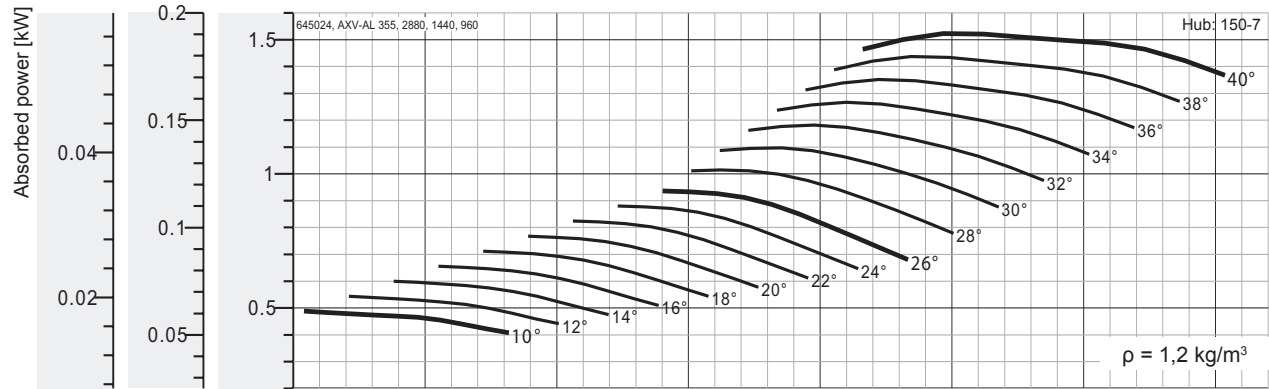

Speed
[min⁻¹]

2880
2-pol

1440
4-pol

960
6-pol

Peak absorbed power [kW]

n [min ⁻¹]	Pitch angle [°]																
	8	10	12	14	16	18	20	22	24	26	28	30	32	34	36	38	40
960 motor	-	0,018	0,020	0,022	0,024	0,026	0,028	0,031	0,033	0,035	0,038	0,041	0,044	0,047	0,050	0,053	0,056
		0,37															
1440 motor	-	0,061	0,068	0,075	0,082	0,089	0,096	0,103	0,110	0,117	0,127	0,137	0,148	0,158	0,169	0,180	0,190
		0,37															
2880 motor	-	0,488	0,544	0,600	0,656	0,712	0,768	0,824	0,880	0,936	1,01	1,10	1,18	1,267	1,352	1,44	1,52
		0,55	0,75				1,1						1,5				2,2

Fan test laboratory AMCA 210/99 Fig.12, Test Chamber. Performance certified is for installation type D - Ducted inlet, Ducted outlet. Performance ratings do not include the effects of appurtenances (accessories-belt cover, pulley & belt).

Sound power frequency spectrum L_{wrel} Page 54-55

The A-weighted sound ratings shown have been calculated per AMCA International Standard 301. Values shown are for inlet LwA sound power levels for installation Type D: ducted inlet, ducted outlet. Ratings include the effects of duct end correction.

Dimensions + Accessories Page 49-52

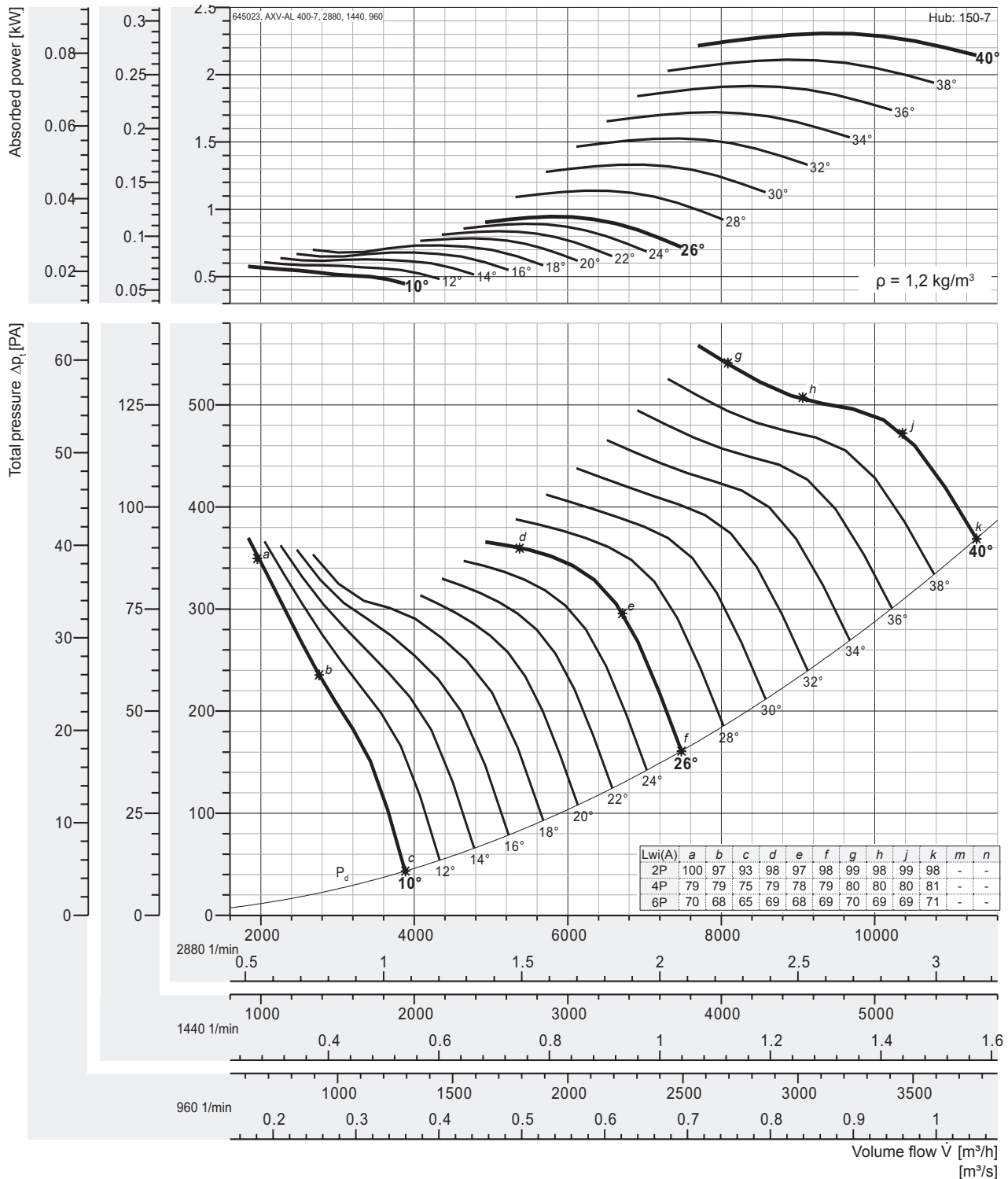

Peak absorbed power [kW]

n [min ⁻¹]	Pitch angle [°]																
	8	10	12	14	16	18	20	22	24	26	28	30	32	34	36	38	40
960 motor	-	0,021	0,022	0,024	0,025	0,027	0,029	0,031	0,033	0,035	0,042	0,049	0,057	0,064	0,071	0,078	0,085
		0,37															
1440 motor	-	0,072	0,076	0,080	0,085	0,092	0,098	0,105	0,111	0,118	0,142	0,166	0,191	0,215	0,240	0,264	0,288
		0,37															
2880 motor	-	0,576	0,607	0,638	0,679	0,733	0,784	0,838	0,892	0,946	1,14	1,33	1,53	1,72	1,92	2,11	2,31
		0,75					1,1				1,5	2,2					3

Fan test laboratory AMCA 210/99 Fig.12, Test Chamber. Performance certified is for installation type D - Ducted inlet, Ducted outlet. Performance ratings do not include the effects of appurtenances (accessories-belt cover, pulley & belt).

Sound power frequency spectrum L_{wref} Page 54-55

The A-weighted sound ratings shown have been calculated per AMCA International Standard 301. Values shown are for inlet LwiA sound power levels for installation Type D: ducted inlet, ducted outlet. Ratings include the effects of duct end correction.

Dimensions + Accessories Page 49-52



Performance Curve

AXV 450, 50 Hz

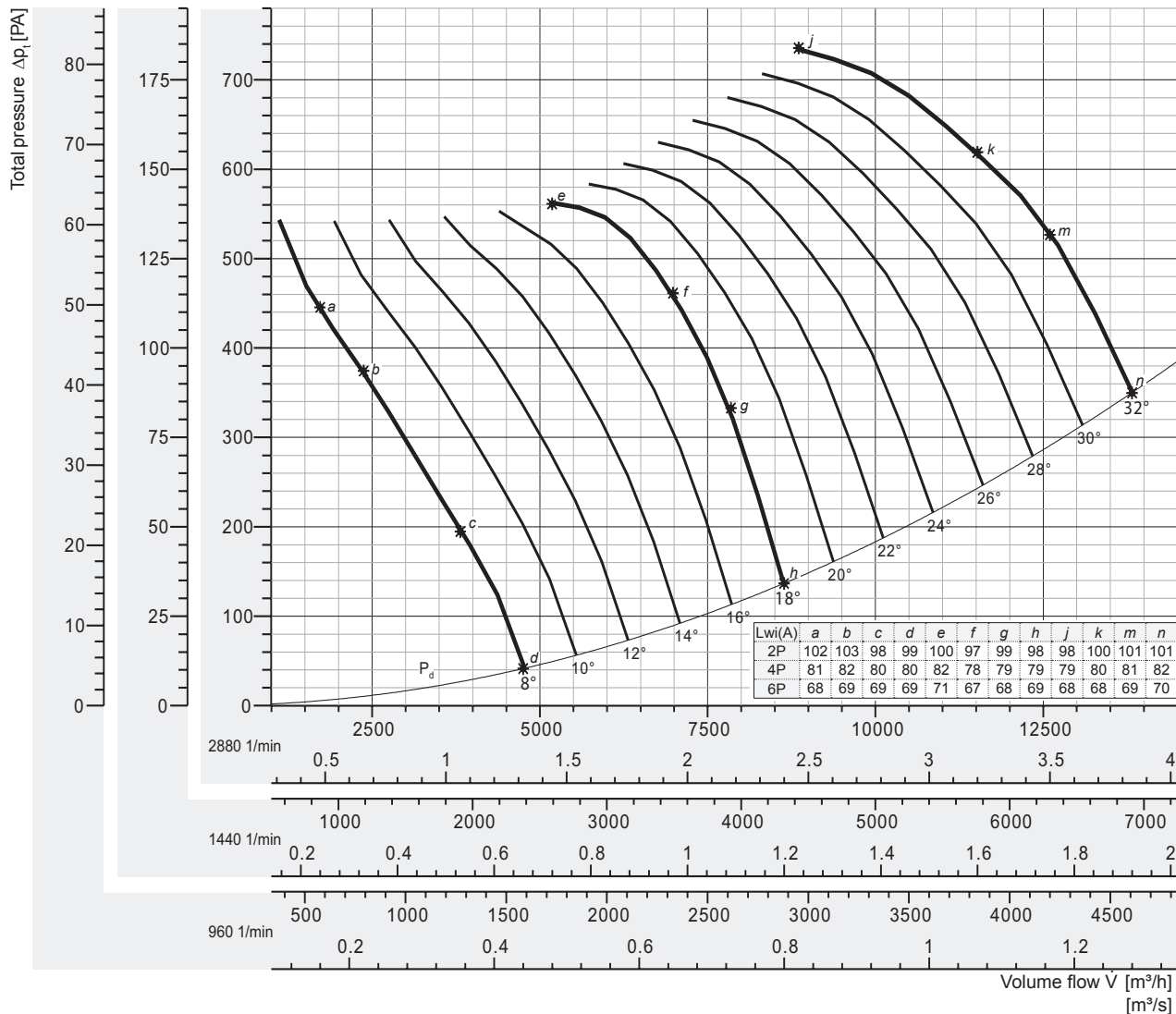
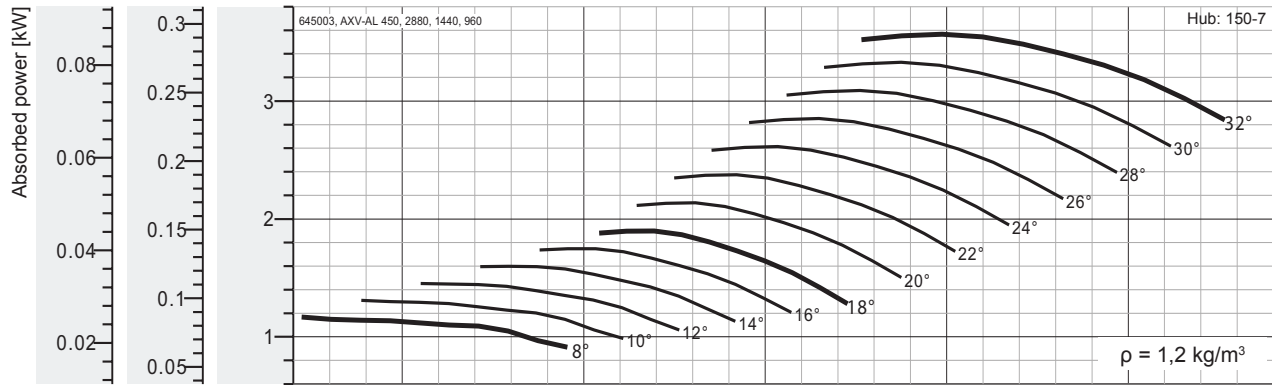

Speed [min⁻¹]
 2880 2-pol
 1440 4-pol
 960 6-pol

Peak absorbed power [kW]

n [min ⁻¹]	Pitch angle [°]																
	8	10	12	14	16	18	20	22	24	26	28	30	32	34	36	38	40
960 motor	0,043	0,049	0,054	0,059	0,065	0,070	0,079	0,088	0,097	0,106	0,114	0,123	0,132	-	-	-	-
	0,37																
1440 motor	0,146	0,164	0,182	0,200	0,218	0,237	0,267	0,297	0,327	0,356	0,386	0,416	0,446	-	-	-	-
	0,37																
												0,55					
2880 motor	1,17	1,31	1,45	1,60	1,75	1,90	2,14	2,38	2,61	2,852	3,09	3,33	3,567	-	-	-	-
	1,5			2,2		3			4								

Fan test laboratory AMCA 210/99 Fig.12, Test Chamber. Performance certified is for installation type D - Ducted inlet, Ducted outlet. Performance ratings do not include the effects of appurtenances (accessories-belt cover, pulley & belt).

Sound power frequency spectrum L_{wref} Page 54-55

The A-weighted sound ratings shown have been calculated per AMCA International Standard 301. Values shown are for inlet LwA sound power levels for installation Type D: ducted inlet, ducted outlet. Ratings include the effects of duct end correction.

Dimensions + Accessories Page 49-52

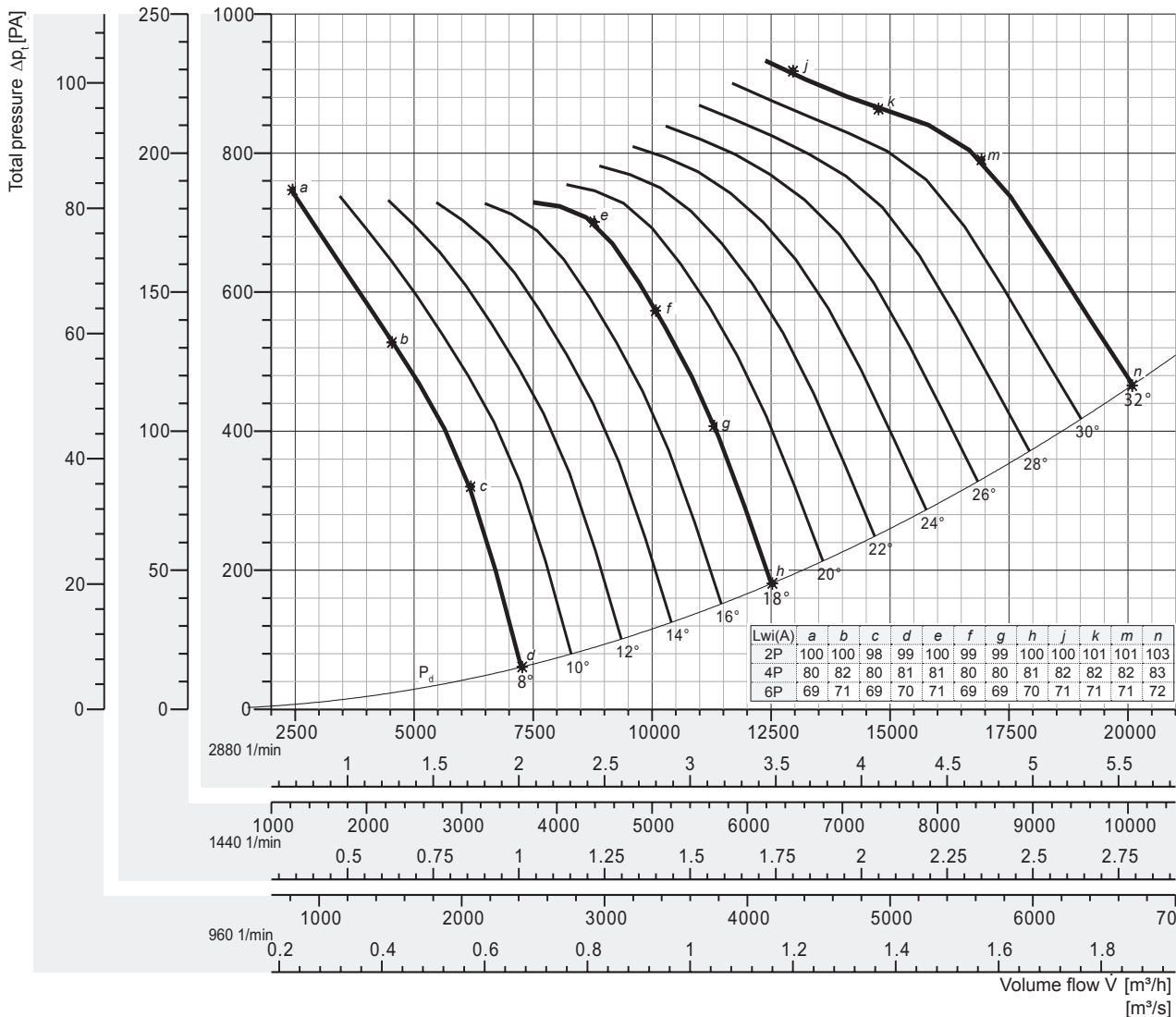
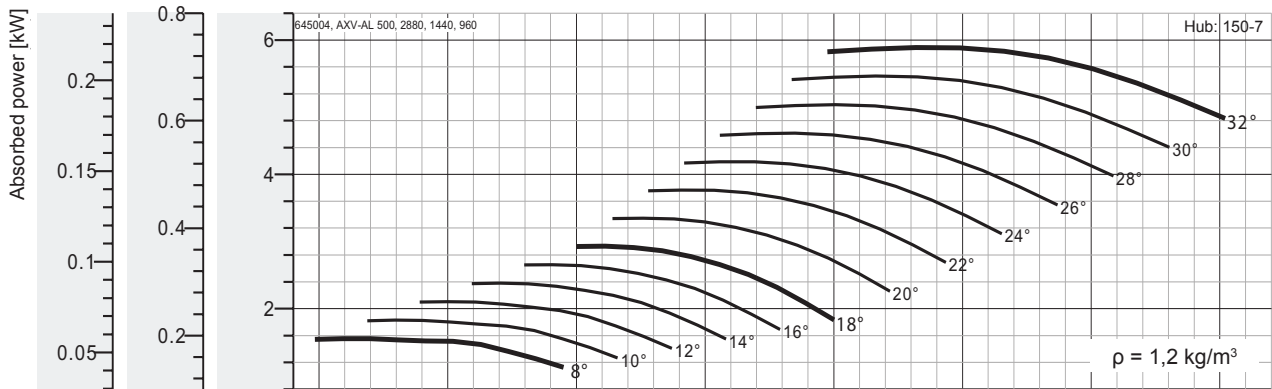

Speed [min⁻¹]
2880 2-pol
1440 4-pol
960 6-pol

Peak absorbed power [kW]

* Out of Range

n [min ⁻¹]	Pitch angle [°]																
	8	10	12	14	16	18	20	22	24	26	28	30	32	34	36	38	40
960 motor	0,058	0,068	0,078	0,088	0,098	0,108	0,124	0,141	0,155	0,171	0,187	0,202	0,218	-	-	-	-
	0,37																
1440 motor	0,194	0,228	0,262	0,297	0,331	0,366	0,419	0,471	0,524	0,577	0,630	0,683	0,736	-	-	-	-
	0,37						0,55			0,75							
2880 motor	1,55	1,83	2,10	2,37	2,65	2,93	3,35	3,77	4,19	4,61	5,04	5,46	5,89	-	-	-	-
	2,2			3			4		-*								

Fan test laboratory AMCA 210/99 Fig.12, Test Chamber. Performance certified is for installation type D - Ducted inlet, Ducted outlet. Performance ratings do not include the effects of appurtenances (accessories-belt cover, pulley & belt).

The A-weighted sound ratings shown have been calculated per AMCA International Standard 301. Values shown are for inlet LwiA sound power levels for installation Type D: ducted inlet, ducted outlet. Ratings include the effects of duct end correction.



Performance Curve

AXV 560, 50 Hz

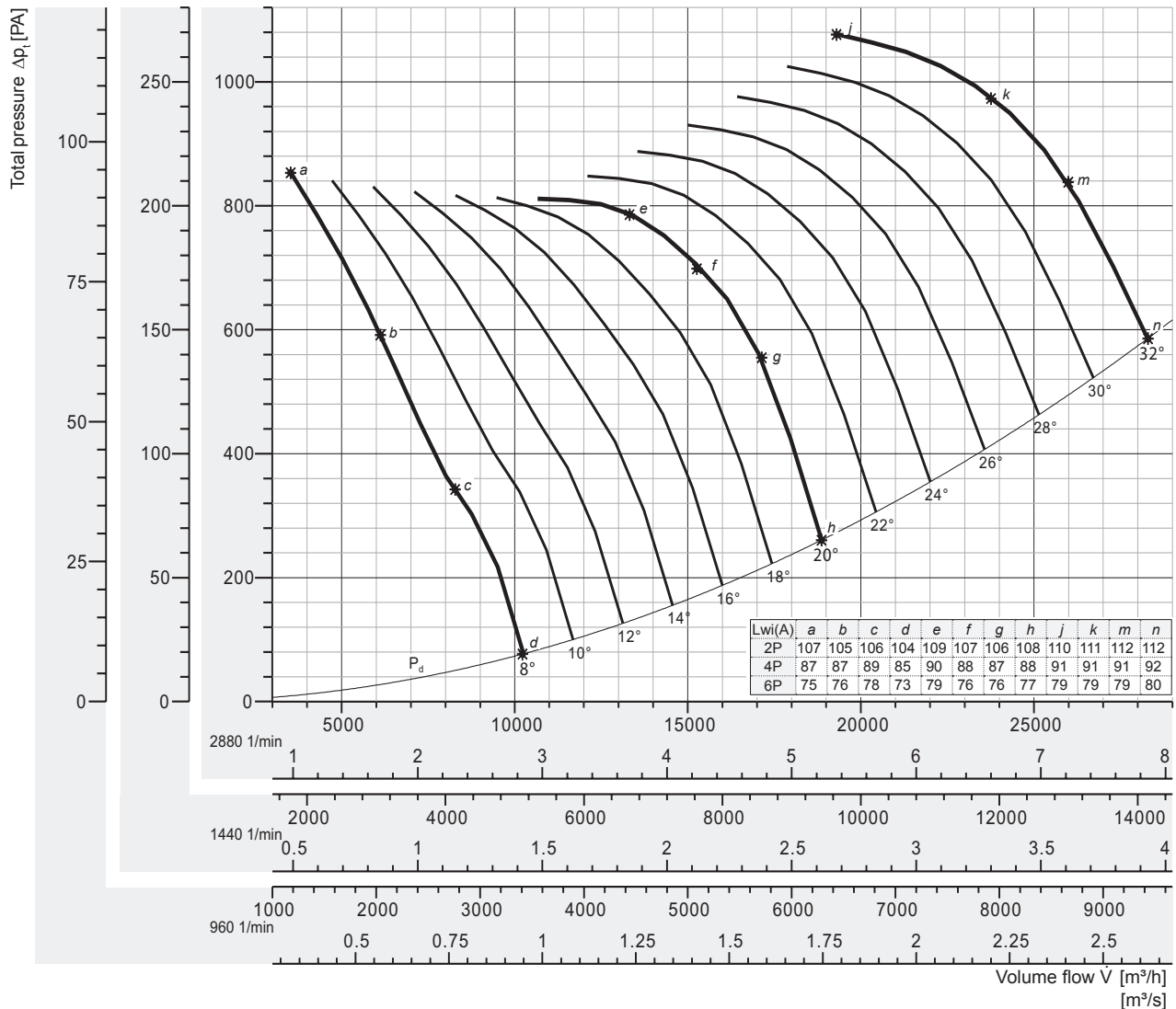
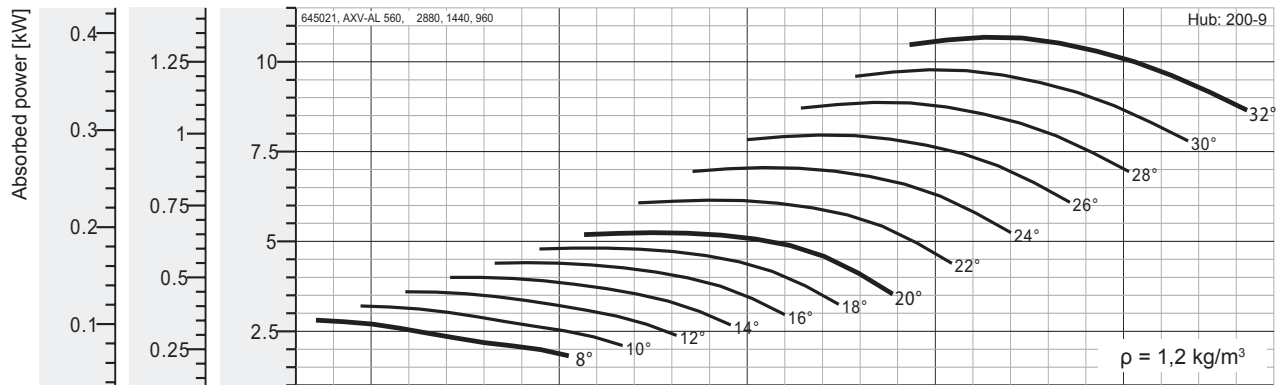

Speed [min⁻¹]
 2880 2-pol
 1440 4-pol
 960 6-pol

Peak absorbed power [kW]

n [min ⁻¹]	Pitch angle [°]																
	8	10	12	14	16	18	20	22	24	26	28	30	32	34	36	38	40
960 motor	0,104	0,119	0,133	0,148	0,163	0,178	0,194	0,228	0,261	0,295	0,329	0,362	0,396	-	-	-	-
	0,37												0,55				
1440 motor	0,351	0,401	0,450	0,500	0,551	0,602	0,655	0,769	0,882	0,995	1,11	1,22	1,34	-	-	-	-
	0,37	0,55			0,75			1,1			1,5						
2880 motor	2,81	3,21	3,60	4,01	4,41	4,82	5,24	6,15	7,06	7,96	8,87	9,78	10,7	-	-	-	-
	3	4			5,5			7,5			11						

Fan test laboratory AMCA 210/99 Fig.12, Test Chamber. Performance certified is for installation type D - Ducted inlet, Ducted outlet. Performance ratings do not include the effects of appurtenances (accessories-belt cover, pulley & belt).

The A-weighted sound ratings shown have been calculated per AMCA International Standard 301. Values shown are for inlet Lw(A) sound power levels for installation Type D: ducted inlet, ducted outlet. Ratings include the effects of duct end correction.

Sound power frequency spectrum L_{wref} Page 54-55

Dimensions + Accessories Page 49-52

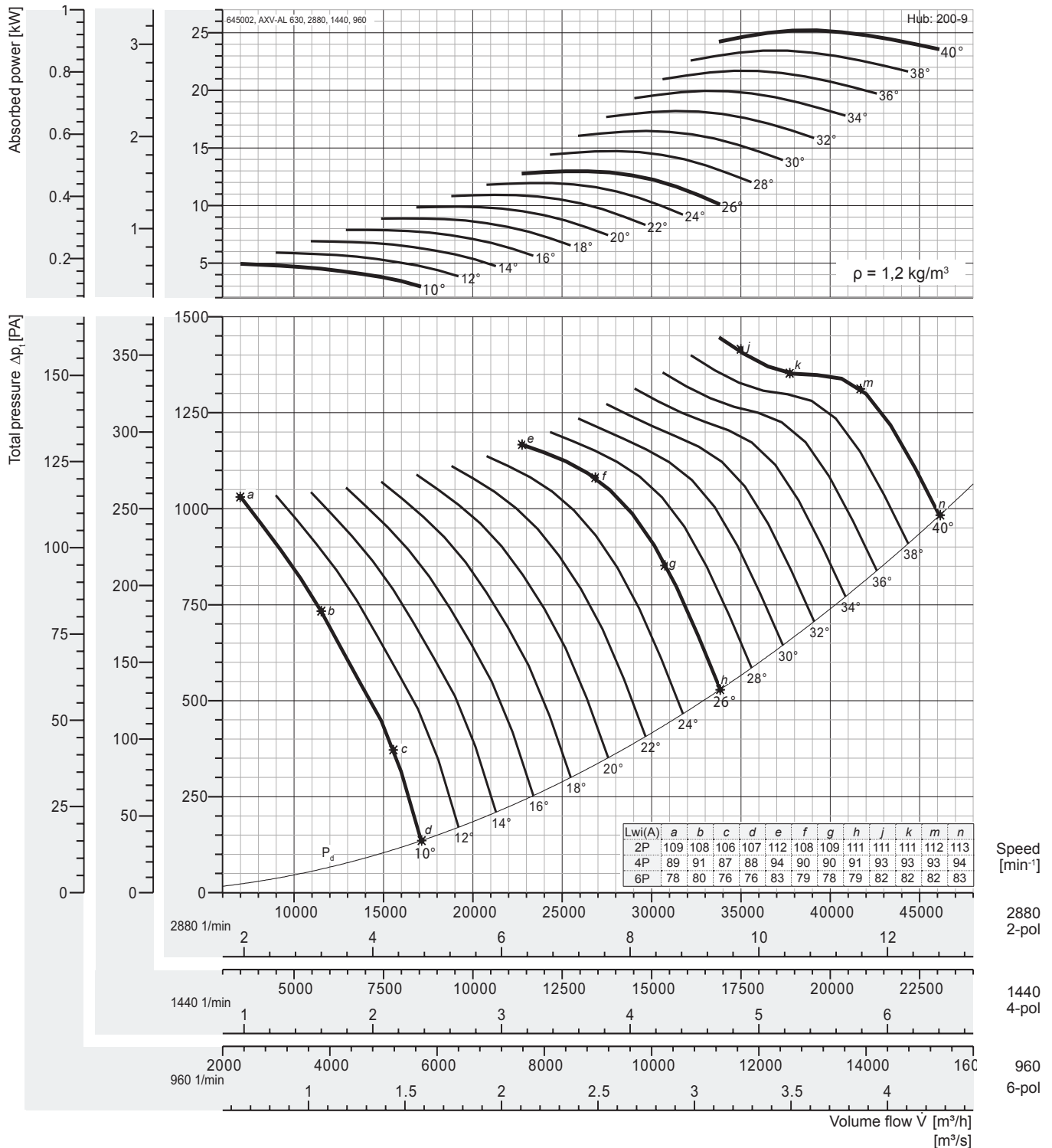

Peak absorbed power [kW]

* Out of Range

n [min ⁻¹]	Pitch angle [°]																
	8	10	12	14	16	18	20	22	24	26	28	30	32	34	36	38	40
960 motor	-	0,183	0,219	0,256	0,292	0,329	0,367	0,405	0,443	0,481	0,545	0,610	0,675	0,739	0,804	0,868	0,934
		0,37						0,55				0,75			1,1		
1440 motor	-	0,618	0,741	0,863	0,986	1,11	1,24	1,37	1,49	1,62	1,84	2,06	2,28	2,50	2,71	2,93	3,15
		0,75		1,1		1,5			2,2			3					4
2880 motor	-	4,94	5,92	6,90	7,88	8,88	9,90	10,9	12,0	13,0	14,7	16,5	18,2	20,0	21,7	23,4	25,2
		5,5	7,5		11				15			18,5		-*			

Fan test laboratory AMCA 210/99 Fig.12, Test Chamber. Performance certified is for installation type D - Ducted inlet, Ducted outlet. Performance ratings do not include the effects of appurtenances (accessories-belt cover, pulley & belt).

Sound power frequency spectrum L_{wref} Page 54-55

The A-weighted sound ratings shown have been calculated per AMCA International Standard 301. Values shown are for inlet Lw(A) sound power levels for installation Type D: ducted inlet, ducted outlet. Ratings include the effects of duct end correction.

Dimensions + Accessories Page 49-52



Performance Curve

AXV 710, 50 Hz

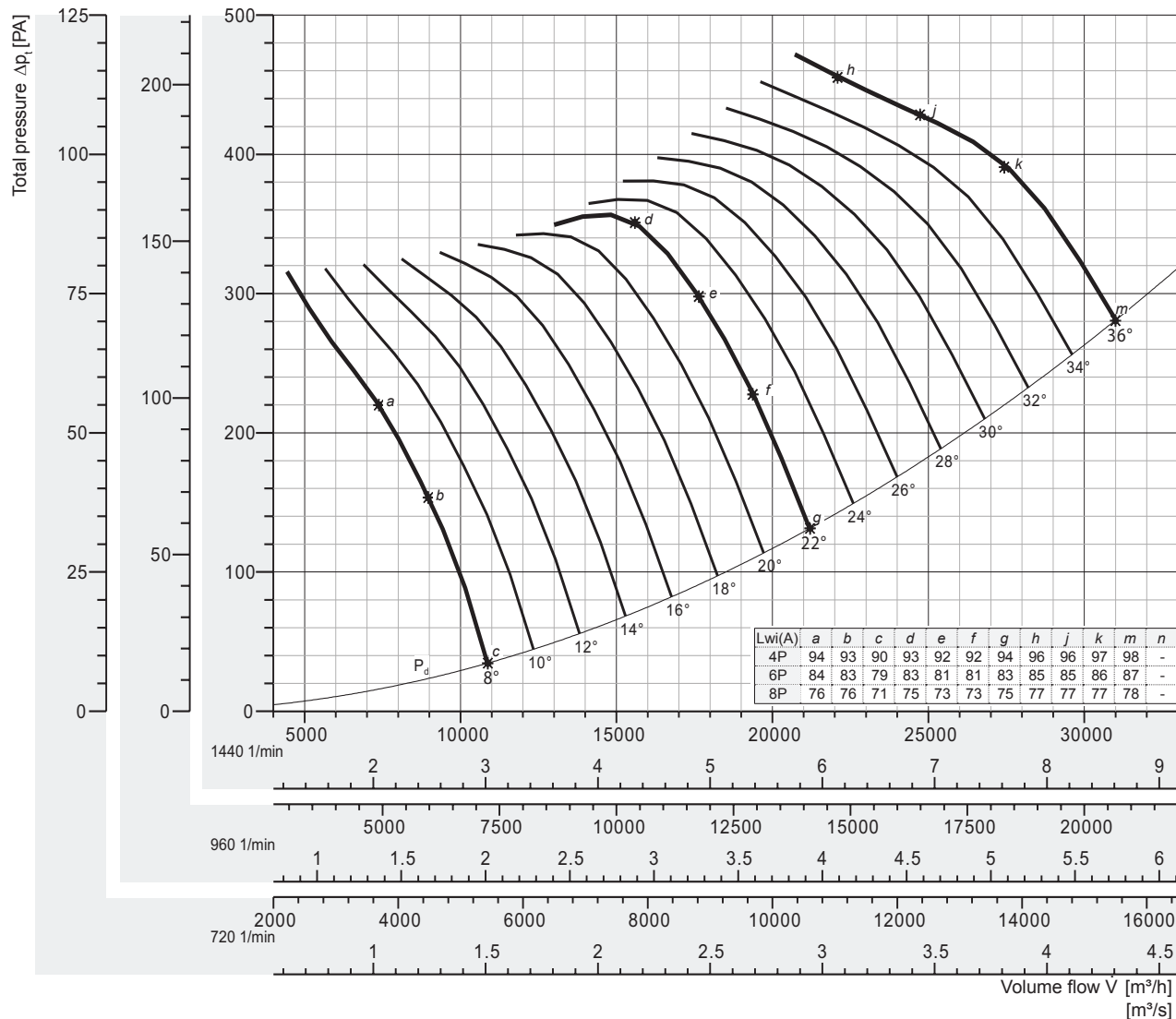
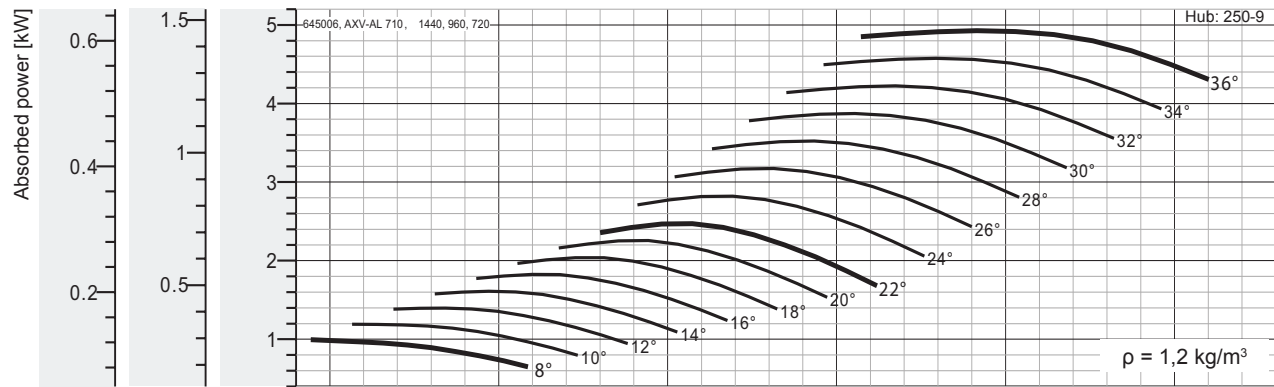

Peak absorbed power [kW]

n [min ⁻¹]	Pitch angle [°]																
	8	10	12	14	16	18	20	22	24	26	28	30	32	34	36	38	40
720 motor	0,125	0,149	0,175	0,201	0,228	0,255	0,282	0,309	0,353	0,397	0,440	0,484	0,528	0,572	0,616	-	-
	0,37									0,55				0,75			
960 motor	0,295	0,353	0,414	0,477	0,541	0,604	0,668	0,732	0,836	0,940	1,04	1,15	1,25	1,36	1,46	-	-
	0,37		0,55			0,75			1,1			1,5					
1440 motor	0,996	1,19	1,40	1,61	1,83	2,04	2,26	2,47	2,82	3,17	3,52	3,87	4,22	4,58	4,93	-	-
	1,1	1,5		2,2			3			4			5,5				

Fan test laboratory AMCA 210/99 Fig.12, Test Chamber. Performance certified is for installation type D - Ducted inlet, Ducted outlet. Performance ratings do not include the effects of appurtenances (accessories-belt cover, pulley & belt).

Sound power frequency spectrum L_{wrel} Page 54-55

The A-weighted sound ratings shown have been calculated per AMCA International Standard 301. Values shown are for inlet LwA sound power levels for installation Type D: ducted inlet, ducted outlet. Ratings include the effects of duct end correction.

Dimensions + Accessories Page 49-52

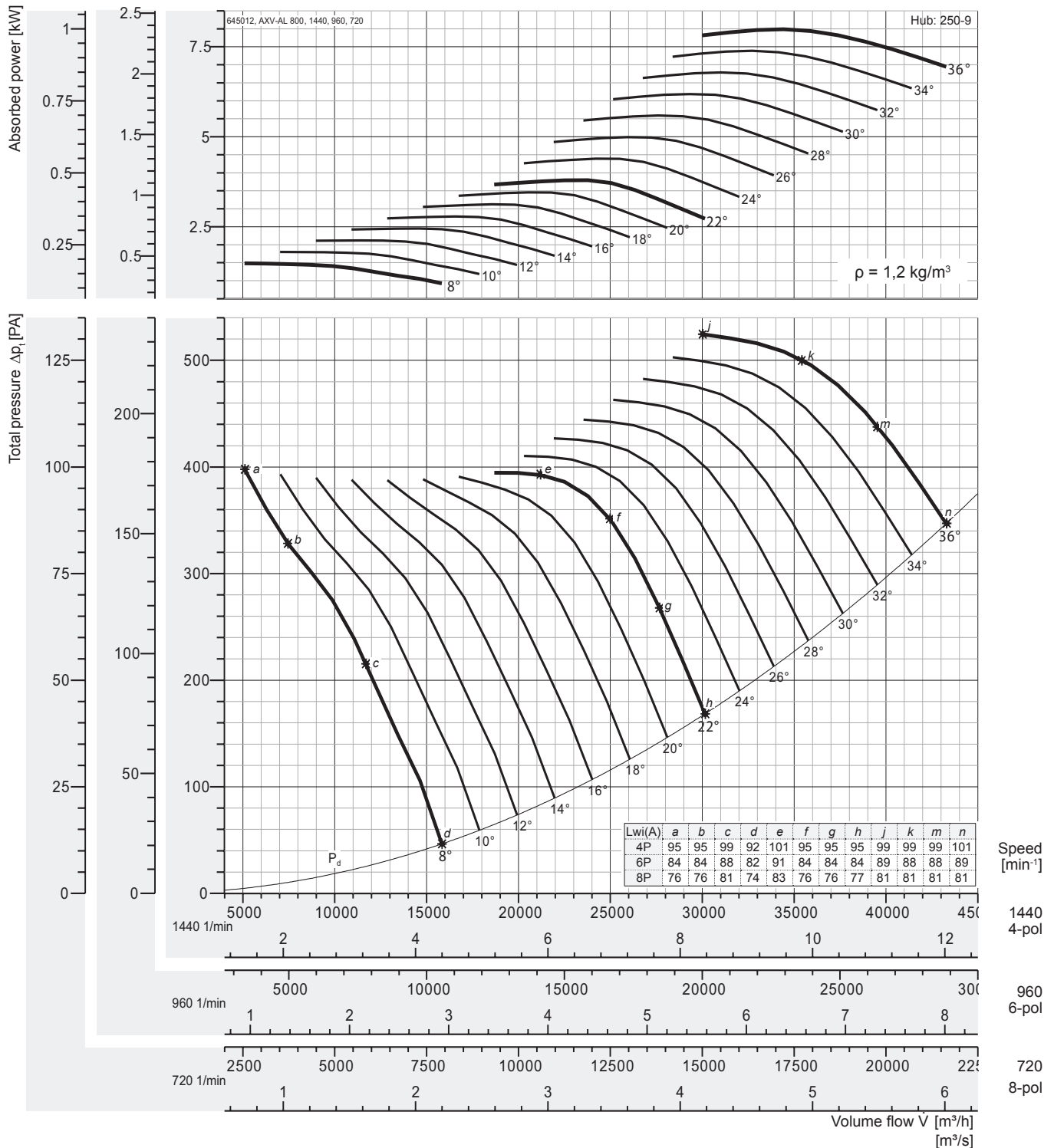

Peak absorbed power [kW]

n [min ⁻¹]	Pitch angle [°]																
	8	10	12	14	16	18	20	22	24	26	28	30	32	34	36	38	40
720 motor	0,186	0,225	0,265	0,306	0,348	0,390	0,432	0,474	0,549	0,624	0,699	0,774	0,849	0,924	0,999	-	-
	0,37					0,55				0,75		1,1					
960 motor	0,440	0,533	0,628	0,726	0,825	0,925	1,02	1,12	1,30	1,48	1,66	1,83	2,01	2,19	2,37	-	-
	0,55		0,75		1,1		1,5				2,2			3			
1440 motor	1,49	1,80	2,12	2,45	2,79	3,12	3,46	3,79	4,39	4,99	5,59	6,19	6,79	7,39	7,99	-	-
	1,5	2,2		3		4			5,5		7,5			11			

Fan test laboratory AMCA 210/99 Fig.12, Test Chamber. Performance certified is for installation type D - Ducted inlet, Ducted outlet. Performance ratings do not include the effects of appurtenances (accessories-belt cover, pulley & belt).

Sound power frequency spectrum L_{wref} Page 54-55

The A-weighted sound ratings shown have been calculated per AMCA International Standard 301. Values shown are for inlet LwiA sound power levels for installation Type D: ducted inlet, ducted outlet. Ratings include the effects of duct end correction.

Dimensions + Accessories Page 49-52



Performance Curve

AXV 900, 50 Hz

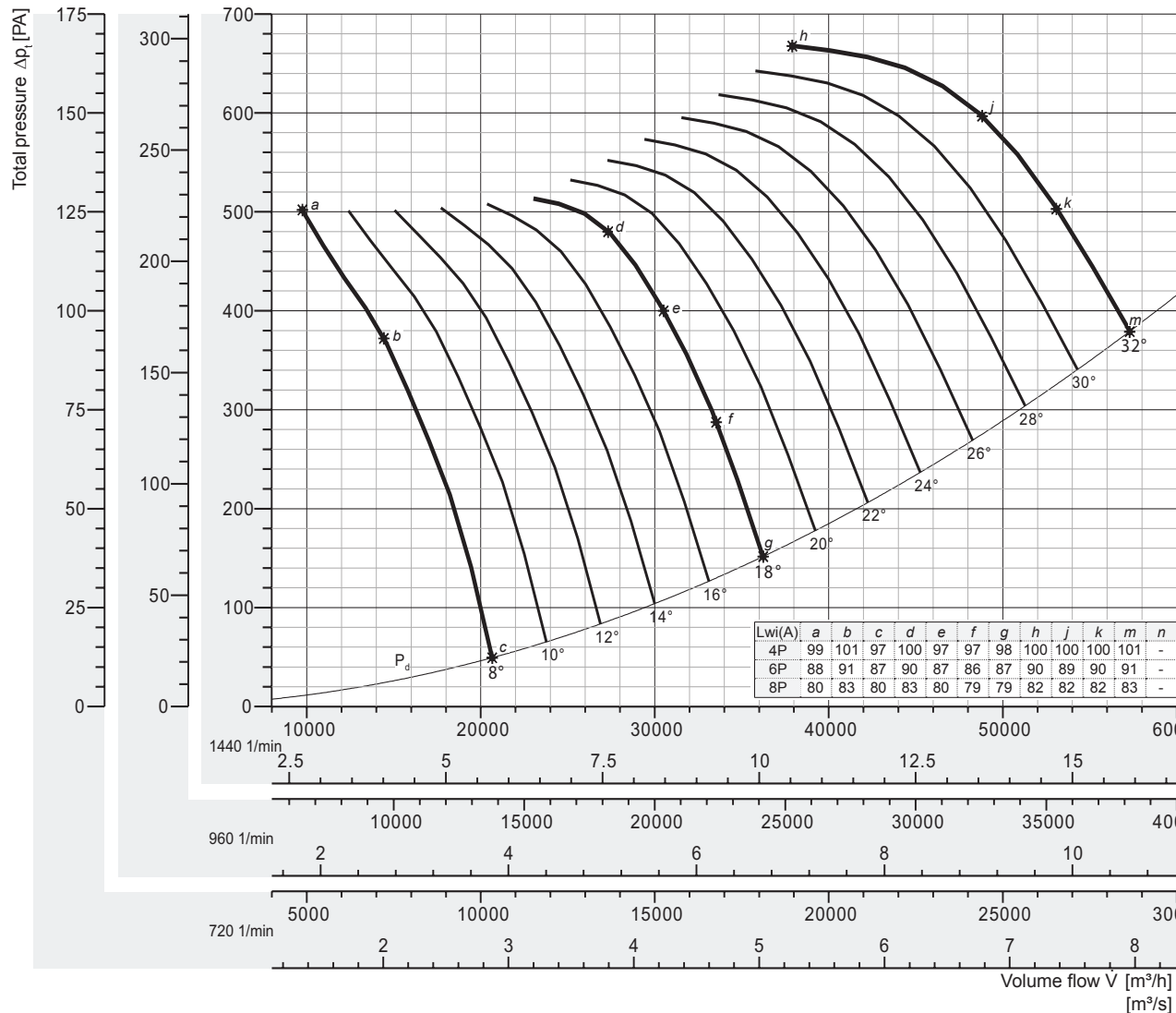
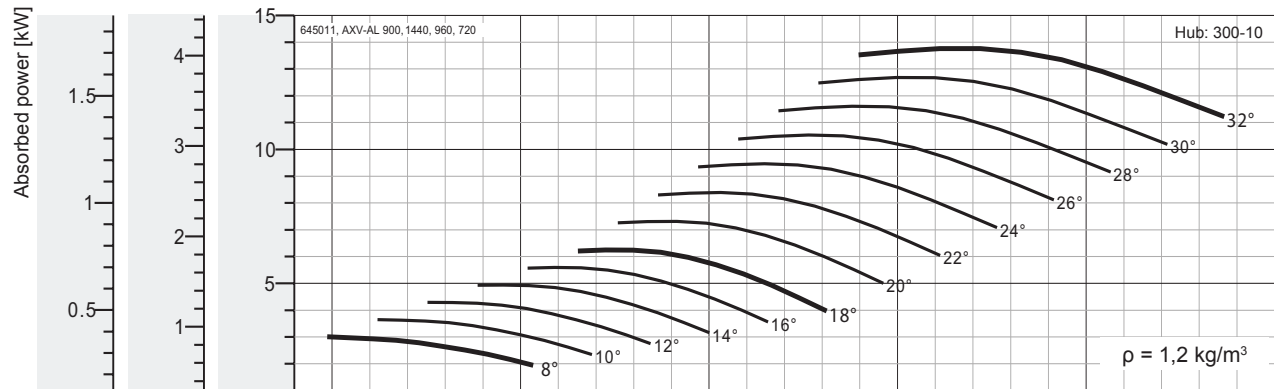

Peak absorbed power [kW]

n [min ⁻¹]	Pitch angle [°]																
	8	10	12	14	16	18	20	22	24	26	28	30	32	34	36	38	40
720 motor	0,376	0,456	0,536	0,617	0,699	0,780	0,914	1,05	1,18	1,32	1,45	1,59	1,72	-	-	-	-
960 motor	0,891	1,08	1,27	1,46	1,66	1,85	2,17	2,49	2,80	3,12	3,44	3,76	4,08	-	-	-	-
1440 motor	3,01	3,64	4,30	4,93	5,59	6,24	7,31	8,39	9,46	10,5	11,6	12,7	13,8	-	-	-	-

Fan test laboratory AMCA 210/99 Fig.12, Test Chamber. Performance certified for installation type D - Ducted inlet, Ducted outlet. Performance ratings do not include the effects of appurtenances (accessories-belt cover, pulley & belt).

The A-weighted sound ratings shown have been calculated per AMCA International Standard 301. Values shown are for inlet Lw(A) sound power levels for installation Type D: ducted inlet, ducted outlet. Ratings include the effects of duct end correction.

Sound power frequency spectrum L_{wref} Page 54-55

Dimensions + Accessories Page 49-52

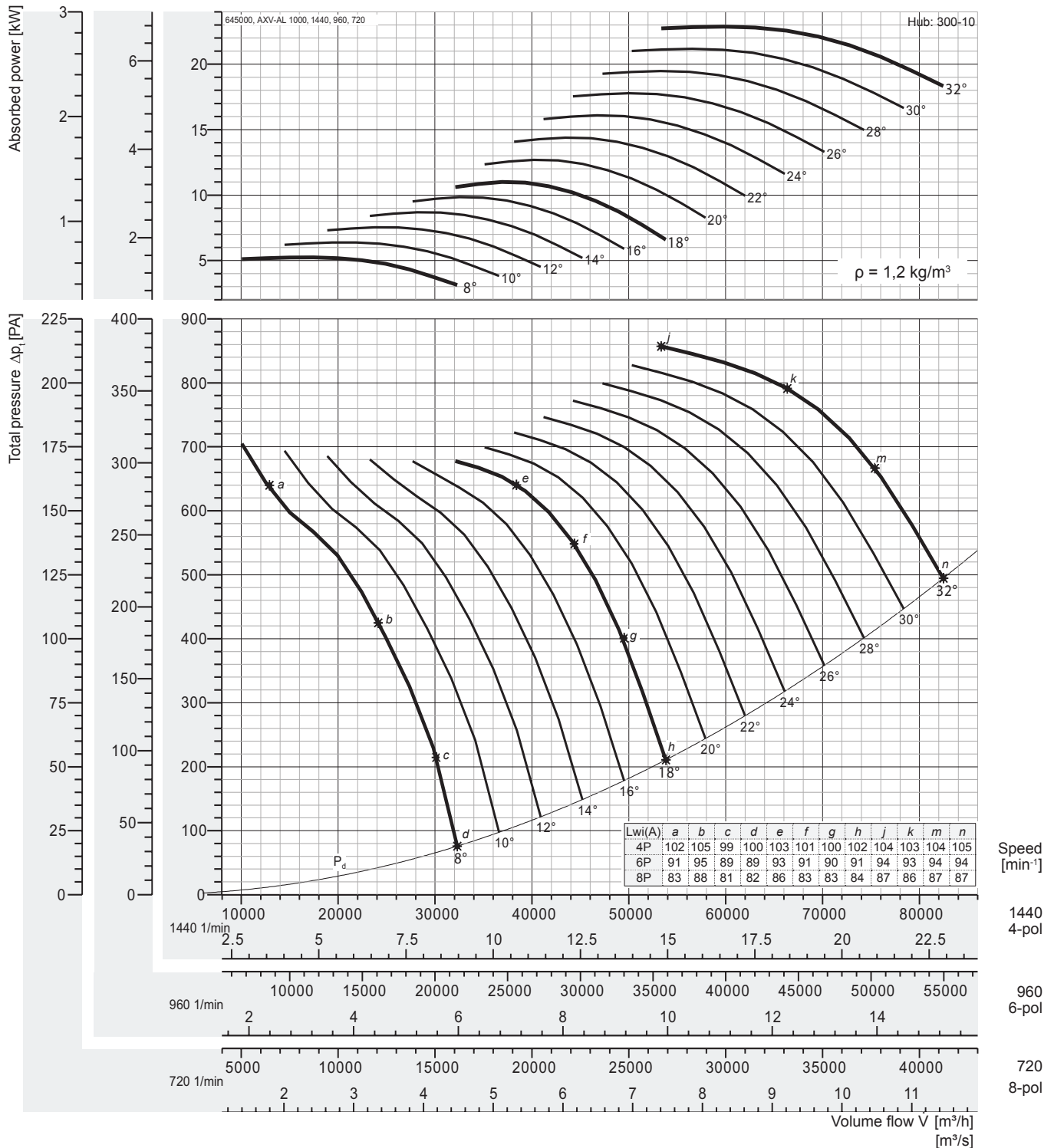

Peak absorbed power [kW]

n [min ⁻¹]	Pitch angle [°]																
	8	10	12	14	16	18	20	22	24	26	28	30	32	34	36	38	40
720 motor	0,654	0,798	0,942	1,09	1,23	1,38	1,59	1,80	2,01	2,22	2,44	2,65	2,86	-	-	-	-
	0,75	1,1			1,5		2,2			3							
960 motor	1,55	1,89	2,23	2,58	2,92	3,26	3,76	4,26	4,77	5,27	5,77	6,27	6,78	-	-	-	-
	2,2		3			4		5,5			7,5						
1440 motor	5,23	6,38	7,54	8,69	9,85	11,0	12,7	14,4	16,1	17,8	19,5	21,2	22,9	-	-	-	-
	5,5	7,5	11				15		18,5		22	30					

Fan test laboratory AMCA 210/99 Fig.12, Test Chamber. Performance certified is for installation type D - Ducted inlet, Ducted outlet. Performance ratings do not include the effects of appurtenances (accessories-belt cover, pulley & belt).

Sound power frequency spectrum L_{wref} Page 54-55

The A-weighted sound ratings shown have been calculated per AMCA International Standard 301. Values shown are for inlet LwiA sound power levels for installation Type D: ducted inlet, ducted outlet. Ratings include the effects of duct end correction.

Dimensions + Accessories Page 49-52

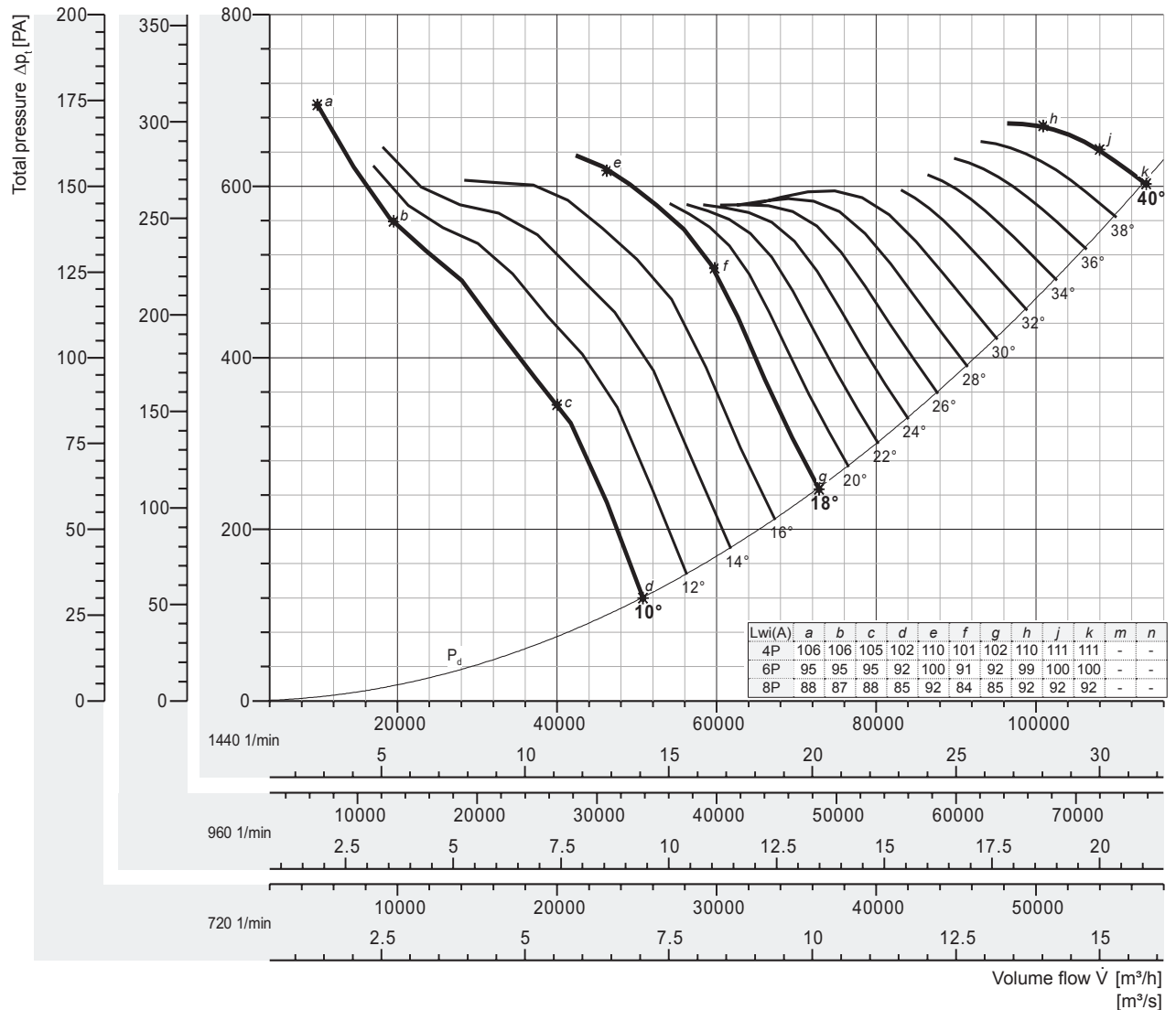
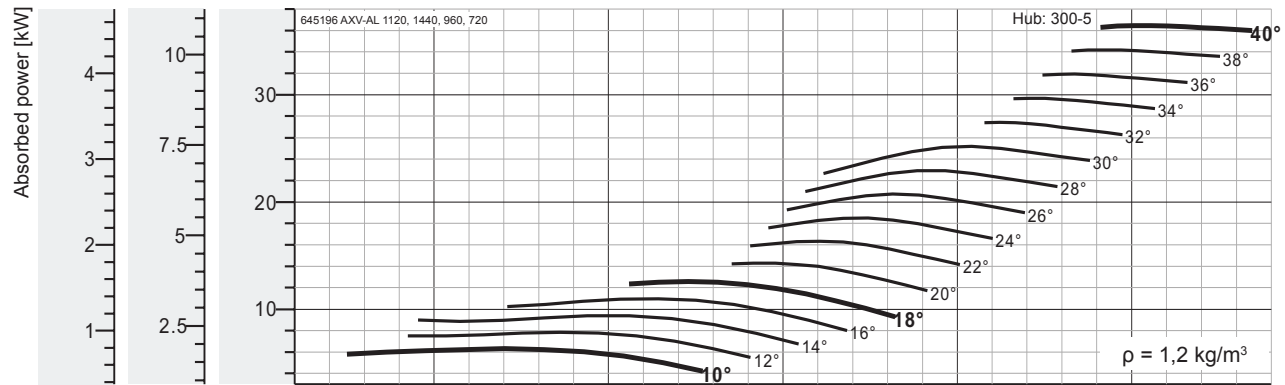

Peak absorbed power [kW]

n [min ⁻¹]	Pitch angle [°]																
	8	10	12	14	16	18	20	22	24	26	28	30	32	34	36	38	40
720 motor	-	0,789	0,98	1,17	1,37	1,57	1,78	2,04	2,32	2,59	2,87	3,15	3,43	3,71	3,99	4,27	4,56
		1,1		1,5		2,2		3		4		5,5					
960 motor	-	1,87	2,32	2,78	3,25	3,73	4,23	4,85	5,49	6,14	6,79	7,46	8,13	8,79	9,46	10,1	10,8
		2,2	3		4		5,5		7,5		11						
1440 motor	-	6,31	7,85	9,39	11,0	12,6	14,3	16,4	18,5	20,7	22,9	25,2	27,4	29,7	31,9	34,2	36,4
		7,5	11		15		18,5		22	30		37					

Fan test laboratory AMCA 210/99 Fig.12, Test Chamber. Performance certified is for installation type D - Ducted inlet, Ducted outlet. Performance ratings do not include the effects of appurtenances (accessories-belt cover, pulley & belt).

The A-weighted sound ratings shown have been calculated per AMCA International Standard 301. Values shown are for inlet Lw(A) sound power levels for installation Type D: ducted inlet, ducted outlet. Ratings include the effects of duct end correction.

Sound power frequency spectrum L_{wref} Page 54-55

Dimensions + Accessories Page 49-52

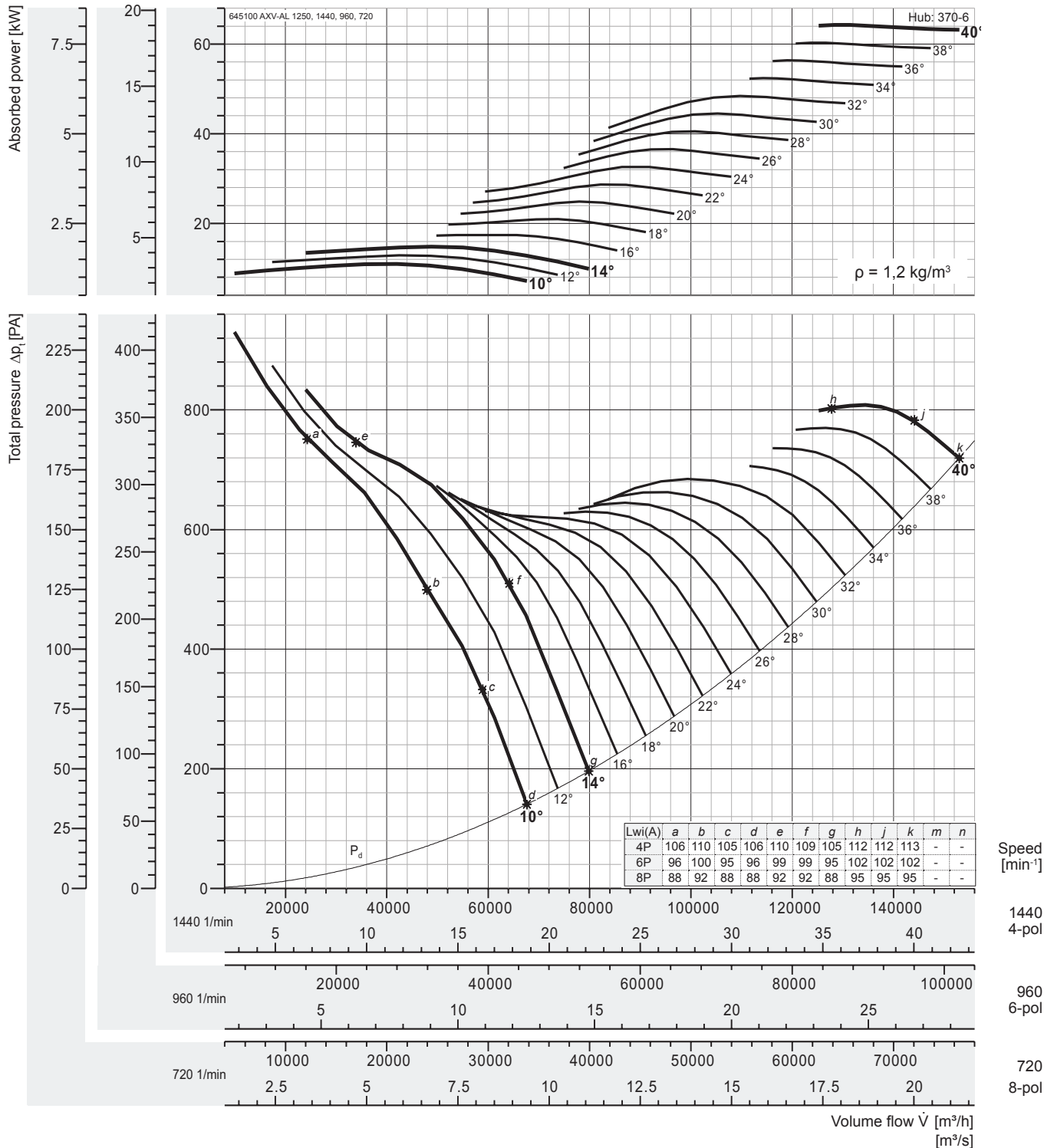

Peak absorbed power [kW]

n [min ⁻¹]	Pitch angle [°]																
	8	10	12	14	16	18	20	22	24	26	28	30	32	34	36	38	40
720 motor	-	1,38	1,61	1,86	2,18	2,63	3,11	3,59	4,08	4,57	5,07	5,57	6,06	6,55	7,05	7,54	8,03
		1,5	2,2			3	4		5,5			7,5				11	
960 motor	-	3,26	3,82	4,40	5,17	6,23	7,37	8,51	9,66	10,8	12,0	13,2	14,4	15,5	16,7	17,9	19,0
		4		5,5		7,5		11			15		18,5				22
1440 motor	-	11,0	12,9	14,8	17,5	21,0	24,9	28,7	32,6	36,6	40,6	44,5	48,5	52,4	56,4	60,3	64,3
		11	15		18,5	22	30		37		45		55		75		

Fan test laboratory AMCA 210/99 Fig.12, Test Chamber. Performance certified is for installation type D - Ducted inlet, Ducted outlet. Performance ratings do not include the effects of appurtenances (accessories-belt cover, pulley & belt).

Sound power frequency spectrum L_{wref} Page 54-55

The A-weighted sound ratings shown have been calculated per AMCA International Standard 301. Values shown are for inlet LwiA sound power levels for installation Type D: ducted inlet, ducted outlet. Ratings include the effects of duct end correction.

Dimensions + Accessories Page 49-52



Performance Curve

AXV 1400, 50 Hz

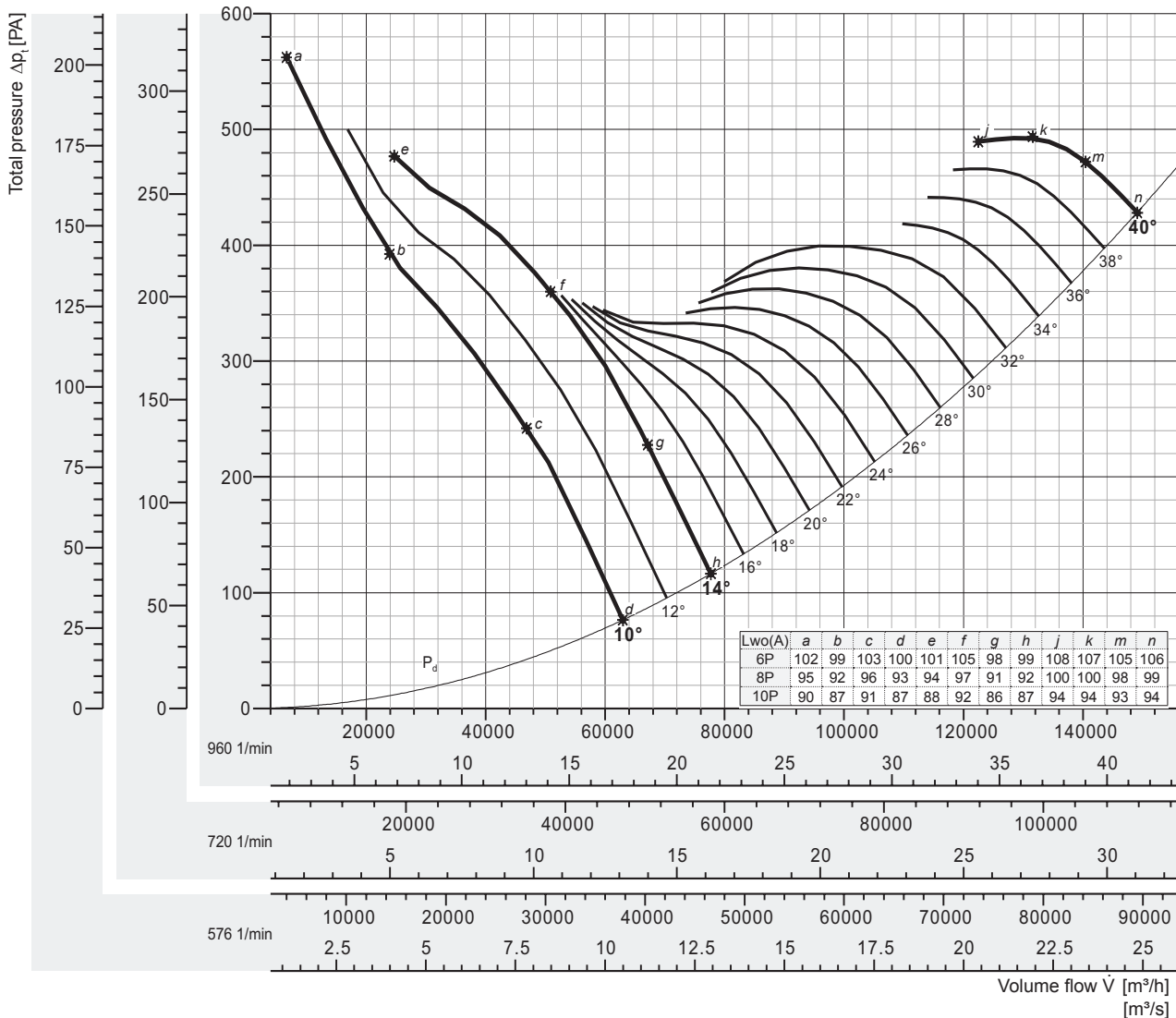
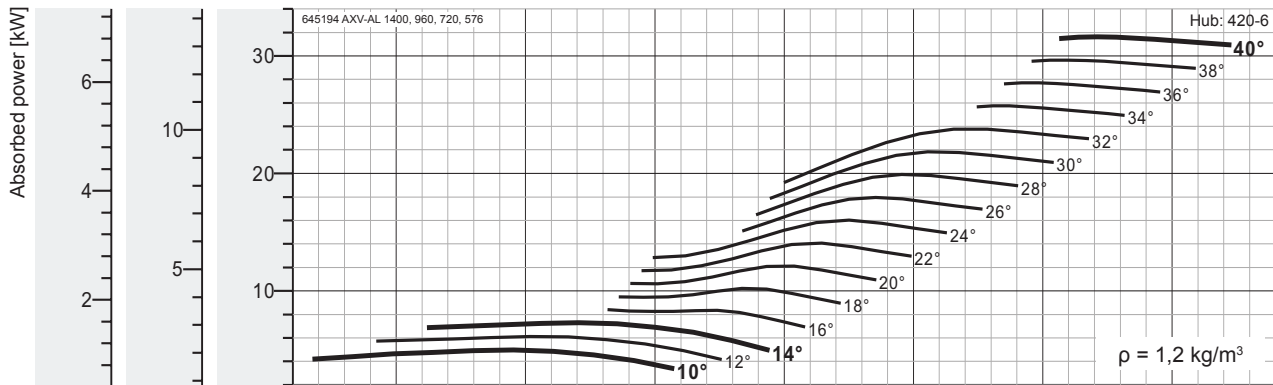

Peak absorbed power [kW]

n [min ⁻¹]	Pitch angle [°]																
	8	10	12	14	16	18	20	22	24	26	28	30	32	34	36	38	40
576 motor	-	1,08	1,33	1,58	1,81	2,20	2,62	3,04	3,46	3,88	4,30	4,72	5,13	5,56	5,98	6,41	6,83
		1,1	1,5	2,2			3		4			5,5				7,5	
720 motor	-	2,10	2,59	3,09	3,54	4,31	5,11	5,94	6,76	7,58	8,40	9,21	10,0	10,9	11,7	12,5	13,3
		2,2	3	4		5,5			7,5			11				15	
960 motor	-	4,98	6,14	7,32	8,40	10,2	12,1	14,1	16,0	18,0	19,9	21,8	23,8	25,7	27,7	29,7	31,6
		5,5	7,5		11		15			18,5		22		30			37

Fan test laboratory AMCA 210/99 Fig. 15, Test Chamber. Performance certified is for installation type A - Free inlet, Free outlet. Performance ratings do not include the effects of appurtenances (accessories-belt cover, pulley & belt).

The A-weighted sound ratings shown have been calculated per AMCA International Standard 301. Values shown are for outlet LwoA sound power levels for installation Type A: free inlet, free outlet.

Sound power frequency spectrum L_{wrel} Page 54-55

Dimensions + Accessories Page 49-52

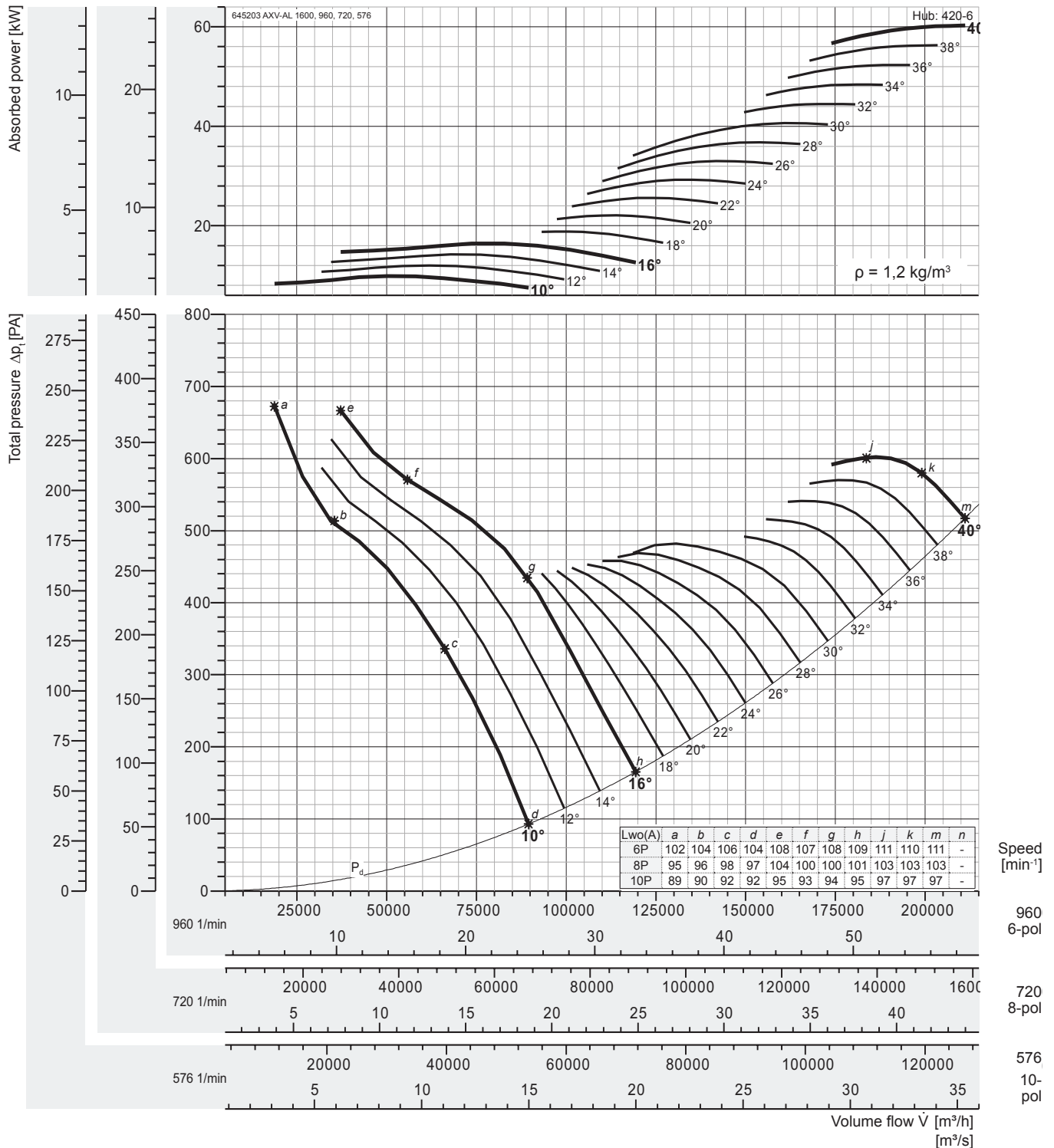

Peak absorbed power [kW]

n [min ⁻¹]	Pitch angle [°]																
	8	10	12	14	16	18	20	22	24	26	28	30	32	34	36	38	40
576 motor	-	2,13	2,60	3,07	3,55	4,07	4,77	5,53	6,32	7,13	7,95	8,78	9,61	10,5	11,3	12,1	13,0
		2,2	3	4		5,5	7,5				11			15			
720 motor	-	4,16	5,08	6,00	6,94	7,94	9,32	10,8	12,3	13,9	15,5	17,1	18,8	20,4	22,0	23,8	25,4
		5,5		7,5		11		15		18,5		22		30			
960 motor	-	9,86	12,0	14,2	16,4	18,8	22,0	25,6	29,3	33,0	36,8	40,6	44,5	48,4	52,3	56,3	60,3
		11	15		18,5	22	30		37		45		55		75		

Fan test laboratory AMCA 210/99 Fig.15, Test Chamber. Performance certified is for installation type A - Free inlet, Free outlet. Performance ratings do not include the effects of appurtenances (accessories-belt cover, pulley & belt).

Sound power frequency spectrum L_{wref} Page 54-55

The A-weighted sound ratings shown have been calculated per AMCA International Standard 301. Values shown are for outlet LwoA sound power levels for installation Type A: free inlet, free outlet.

Dimensions + Accessories Page 49-52



Performance Curve

AXV 1800, 50 Hz

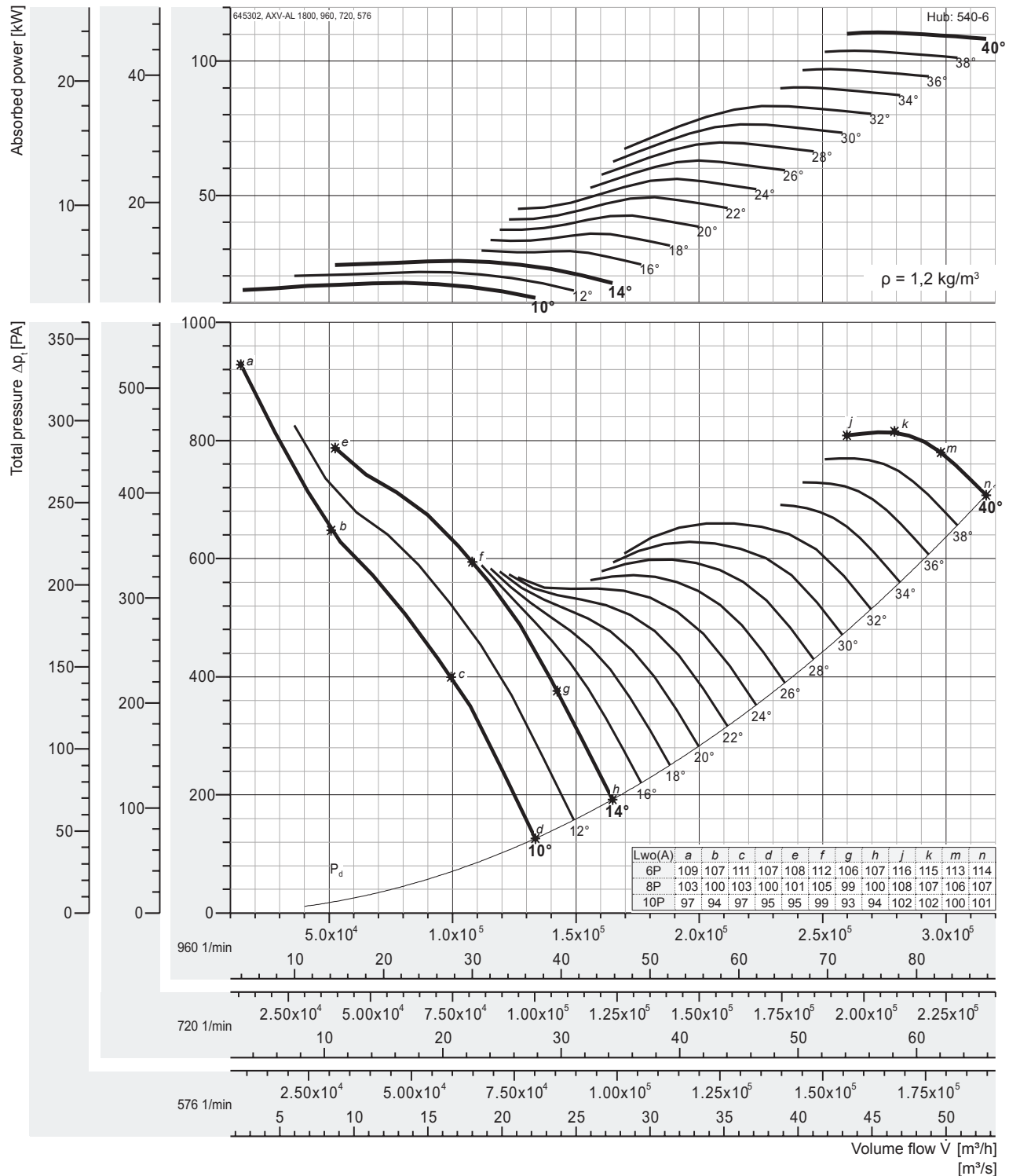

Peak absorbed power [kW]

n [min ⁻¹]	Pitch angle [°]																
	8	10	12	14	16	18	20	22	24	26	28	30	32	34	36	38	40
576 motor	-	3,76	4,64	5,54	6,36	7,73	9,17	10,6	12,1	13,6	15,0	16,5	18,0	19,5	20,9	22,4	23,9
		4	5,5	7,5		11			15			18,5		22		30	
720 motor	-	7,35	9,07	10,8	12,4	15,0	17,9	20,8	23,7	26,6	29,4	32,3	35,1	38,0	40,9	43,8	46,7
		7,5	11		15		18,5	22	30			37		45			55
960 motor	-	17,4	21,5	25,6	29,4	35,8	42,4	49,3	56,1	62,9	69,7	76,5	83,2	90,2	97,0	103,8	110,7
		18,5	22	30		37	45	55	75			90		110			132

Fan test laboratory AMCA 210/99 Fig. 15, Test Chamber. Performance certified is for installation type A - Free inlet, Free outlet. Performance ratings do not include the effects of appurtenances (accessories-belt cover, pulley & belt).

The A-weighted sound ratings shown have been calculated per AMCA International Standard 301. Values shown are for outlet LwoA sound power levels for installation Type A: free inlet, free outlet.

Sound power frequency spectrum L_{wrel} Page 54-55

Dimensions + Accessories Page 49-52

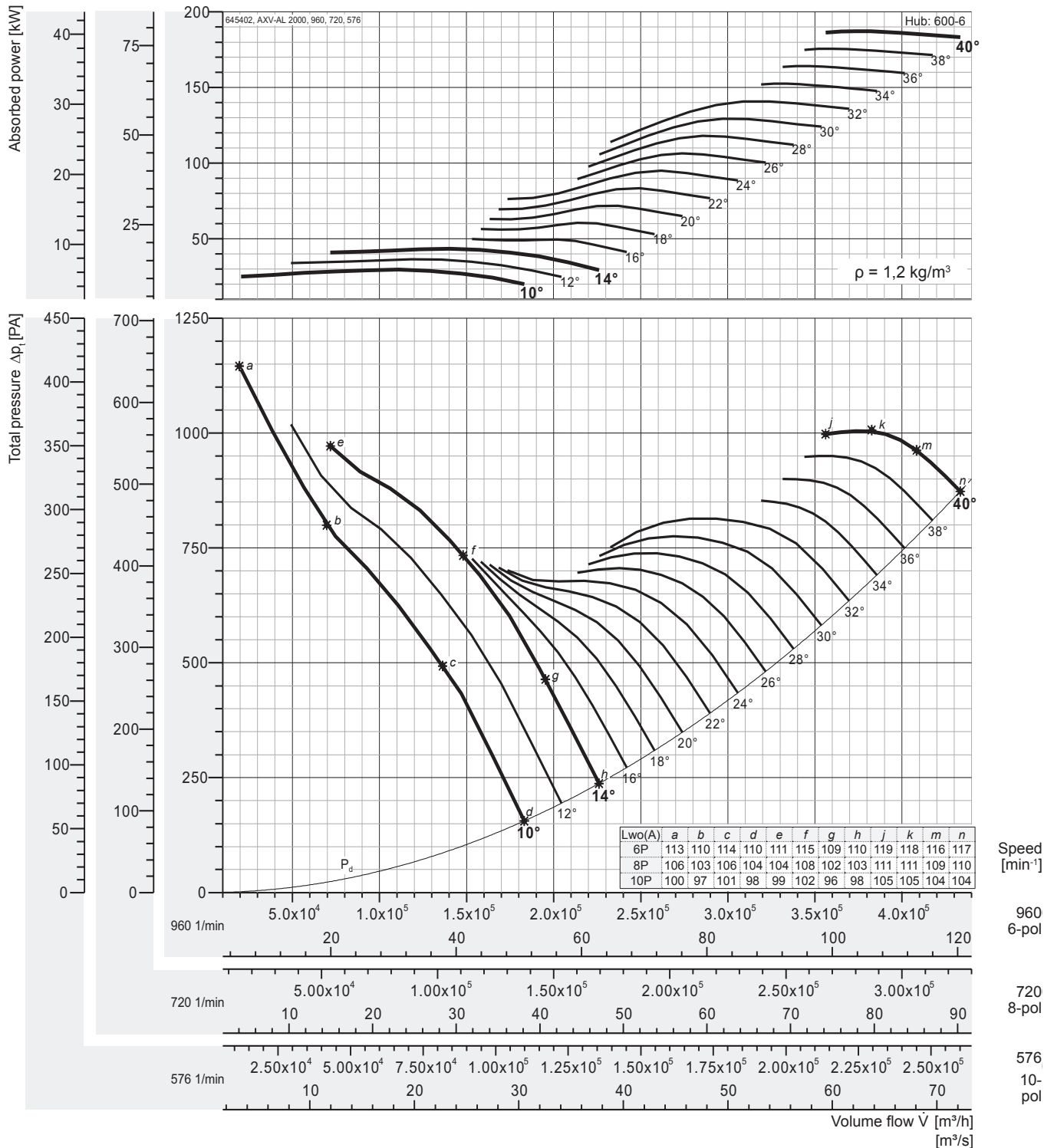

Peak absorbed power [kW]

n [min ⁻¹]	Pitch angle [°]																
	8	10	12	14	16	18	20	22	24	26	28	30	32	34	36	38	40
576 motor	-	6,37	7,85	9,36	10,7	13,1	15,5	18,0	20,5	23,0	25,5	27,9	30,4	32,9	35,4	37,9	40,4
		7,5	11			15	18,5		22	30			37			45	
720 motor	-	12,4	15,3	18,3	21,0	25,5	30,3	35,2	40,0	44,9	49,8	54,6	59,4	64,4	69,2	74,1	79,0
		15	18,5		22	30	37		45	55		75				90	
960 motor	-	29,5	36,3	43,3	49,8	60,5	71,8	83,4	94,9	106,4	117,9	129,4	140,8	152,5	164,1	175,7	187,3
		30	37	45	55	75		90	110		132		160		200		

Fan test laboratory AMCA 210/99 Fig.15, Test Chamber. Performance certified is for installation type A - Free inlet, Free outlet. Performance ratings do not include the effects of appurtenances (accessories-belt cover, pulley & belt).

The A-weighted sound ratings shown have been calculated per AMCA International Standard 301. Values shown are for outlet LwoA sound power levels for installation Type A: free inlet, free outlet.

Sound power frequency spectrum L_{wref} Page 54-55

Dimensions + Accessories Page 49-52

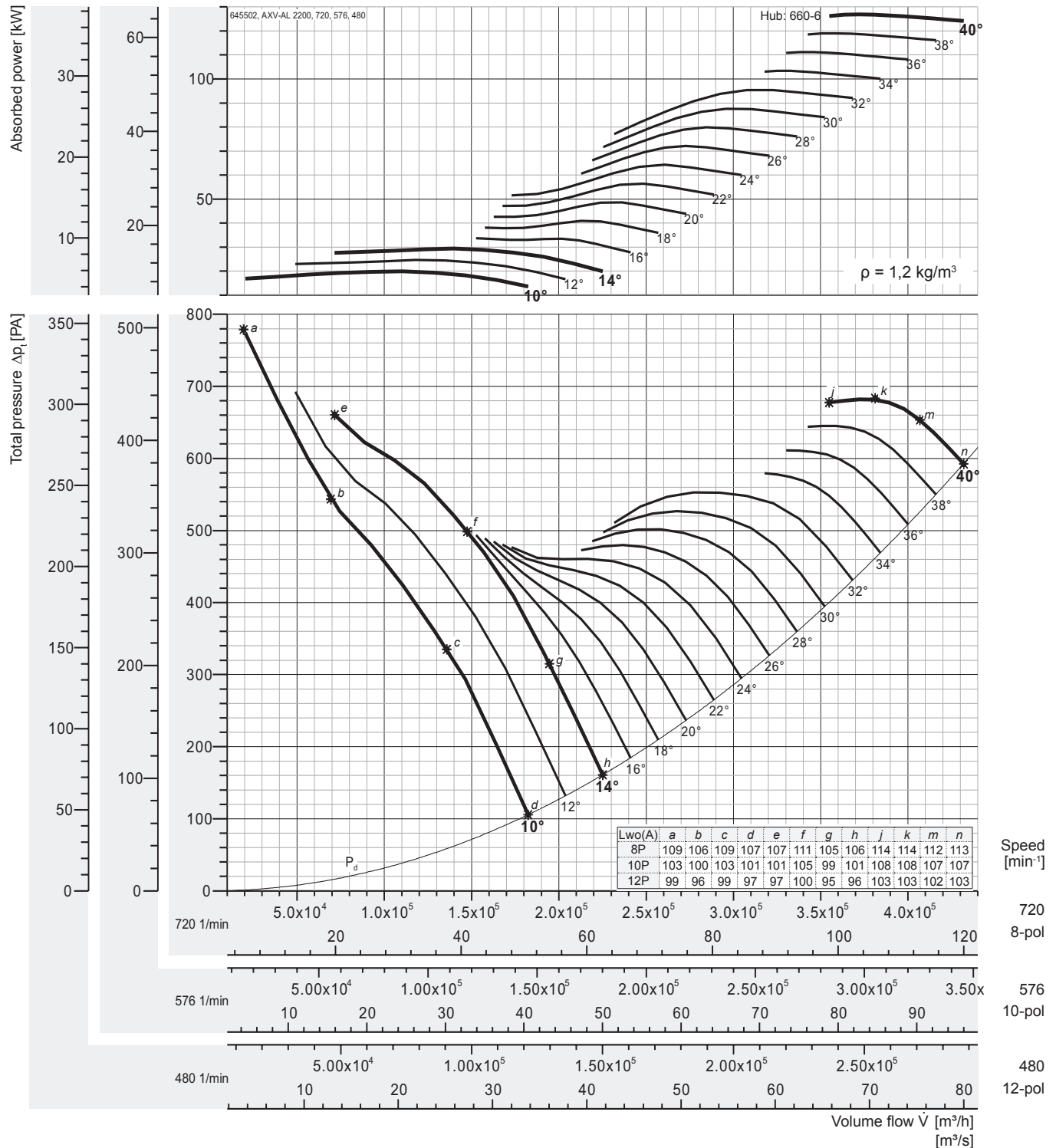

Peak absorbed power [kW]

n [min ⁻¹]	Pitch angle [°]																
	8	10	12	14	16	18	20	22	24	26	28	30	32	34	36	38	40
480 motor	-	5,92	7,30	8,70	9,99	12,1	14,4	16,7	19,1	21,4	23,7	26,0	28,3	30,6	32,9	35,3	37,6
		7,5		11		15		18,5	22		30		37		45		
576 motor	-	10,2	12,6	15,0	17,3	21,0	24,9	28,9	32,9	36,9	40,9	44,9	48,8	52,9	56,9	60,9	64,9
		11	15		18,5	22	30		37		45		55		75		
720 motor	-	20,0	24,6	29,4	33,7	41,0	48,6	56,5	64,3	72,1	79,9	87,6	95,4	103,3	111,1	119,0	126,8
		22	30		37	45	55	75			90		110		132		

Fan test laboratory AMCA 210/99 Fig. 15, Test Chamber. Performance certified is for installation type A - Free inlet, Free outlet. Performance ratings do not include the effects of appurtenances (accessories-belt cover, pulley & belt).

The A-weighted sound ratings shown have been calculated per AMCA International Standard 301. Values shown are for outlet LwoA sound power levels for installation Type A: free inlet, free outlet.

Sound power frequency spectrum L_{wrel} Page 54-55

Dimensions + Accessories Page 49-52

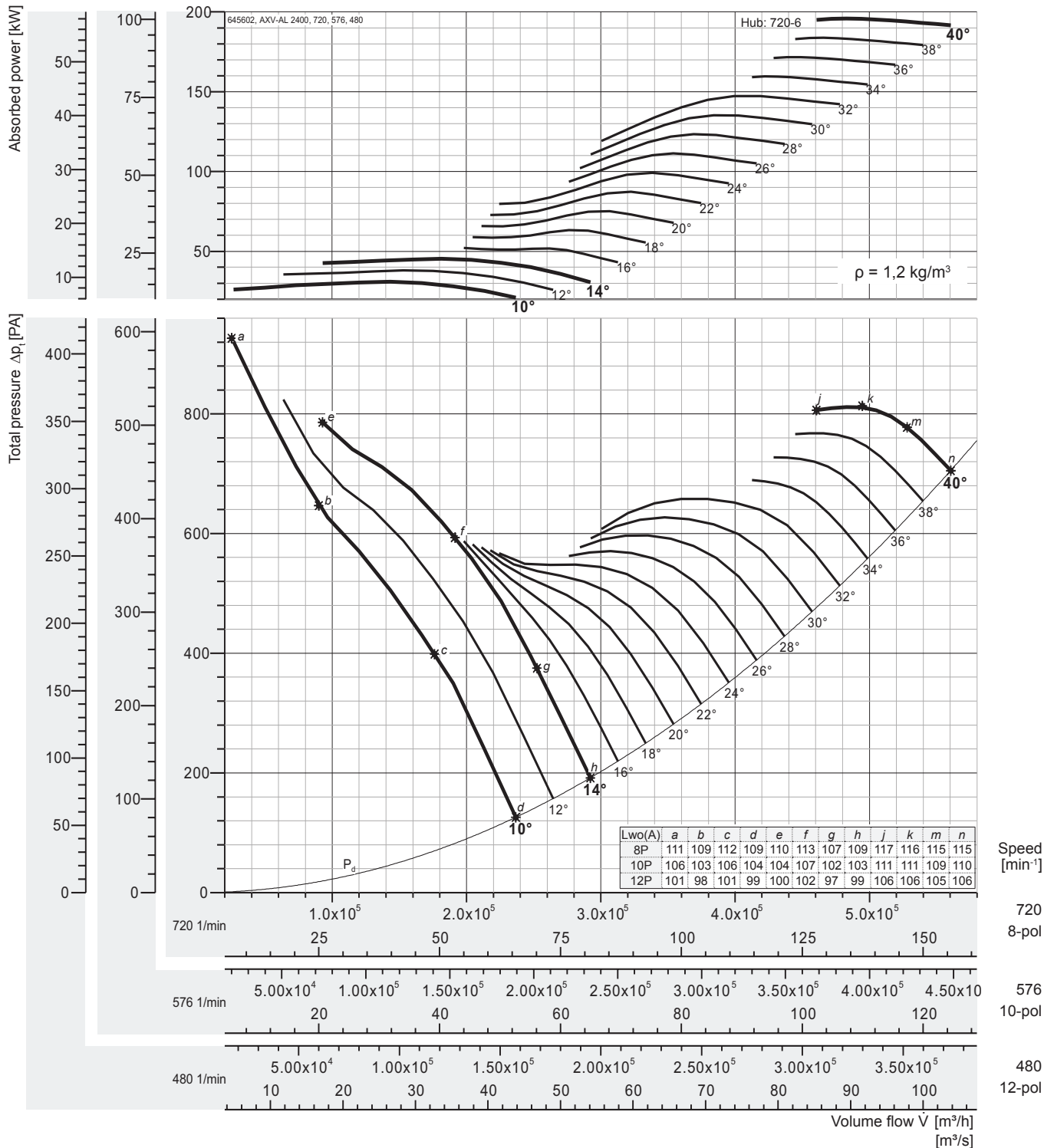

Peak absorbed power [kW]

n [min ⁻¹]	Pitch angle [°]																
	8	10	12	14	16	18	20	22	24	26	28	30	32	34	36	38	40
480 motor	-	9,14	11,3	13,4	15,4	18,7	22,2	25,8	29,4	33,0	36,5	40,1	43,6	47,3	50,9	54,4	58,0
576 motor	-	15,8	19,5	23,2	26,7	32,4	38,4	44,6	50,8	57,0	63,2	69,3	75,4	81,7	87,9	94,1	100,3
720 motor	-	30,8	38,0	45,3	52,1	63,3	75,0	87,2	99,3	111,3	123,3	135,3	147,3	159,5	171,6	183,7	195,8

Fan test laboratory AMCA 210/99 Fig.15, Test Chamber. Performance certified is for installation type A - Free inlet, Free outlet. Performance ratings do not include the effects of appurtenances (accessories-belt cover, pulley & belt).

The A-weighted sound ratings shown have been calculated per AMCA International Standard 301. Values shown are for outlet LwoA sound power levels for installation Type A: free inlet, free outlet.

Sound power frequency spectrum L_{wref} Page 54-55

Dimensions + Accessories Page 49-52

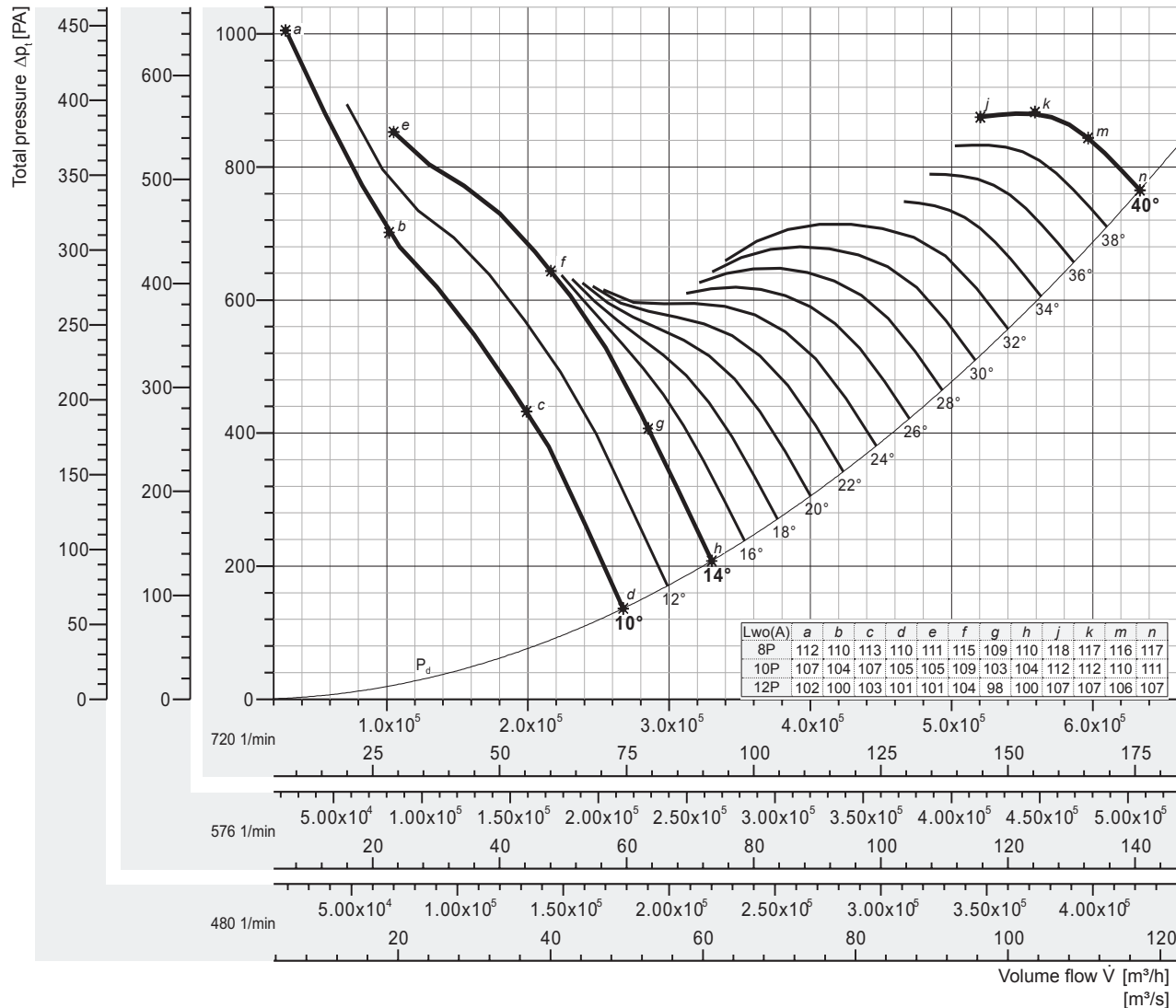
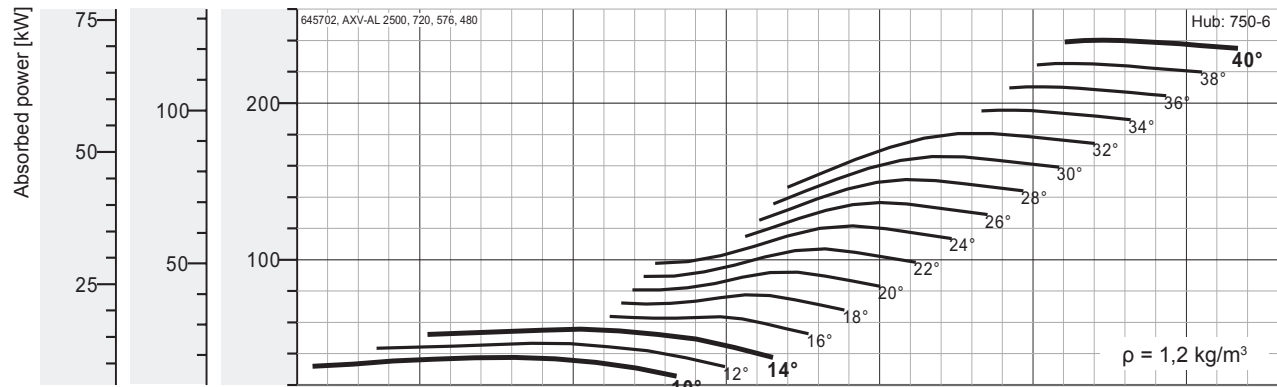

Peak absorbed power [kW]

n [min ⁻¹]	Pitch angle [°]																
	8	10	12	14	16	18	20	22	24	26	28	30	32	34	36	38	40
480 motor	-	11,2	13,8	16,5	18,9	23,0	27,3	31,7	36,1	40,4	44,8	49,2	53,5	57,9	62,4	66,8	71,2
		15		18,5	22	30		37		45		55		75			
576 motor	-	19,4	23,9	28,5	32,7	39,7	47,1	54,7	62,3	69,9	77,4	84,9	92,4	100,1	107,7	115,3	122,9
		22	30		37	45	55		75		90		110		132		
720 motor	-	37,8	46,6	55,6	63,8	77,6	92,1	106,9	121,7	136,5	151,2	165,9	180,6	195,6	210,4	225,3	240,1
		45	55	75		90	110		132	160		200		250			

Fan test laboratory AMCA 210/99 Fig. 15, Test Chamber. Performance certified for installation type A - Free inlet, Free outlet. Performance ratings do not include the effects of appurtenances (accessories-belt cover, pulley & belt).

The A-weighted sound ratings shown have been calculated per AMCA International Standard 301. Values shown are for outlet LwoA sound power levels for installation Type A: free inlet, free outlet.

Sound power frequency spectrum L_{wrel} Page 54-55

Dimensions + Accessories Page 49-52

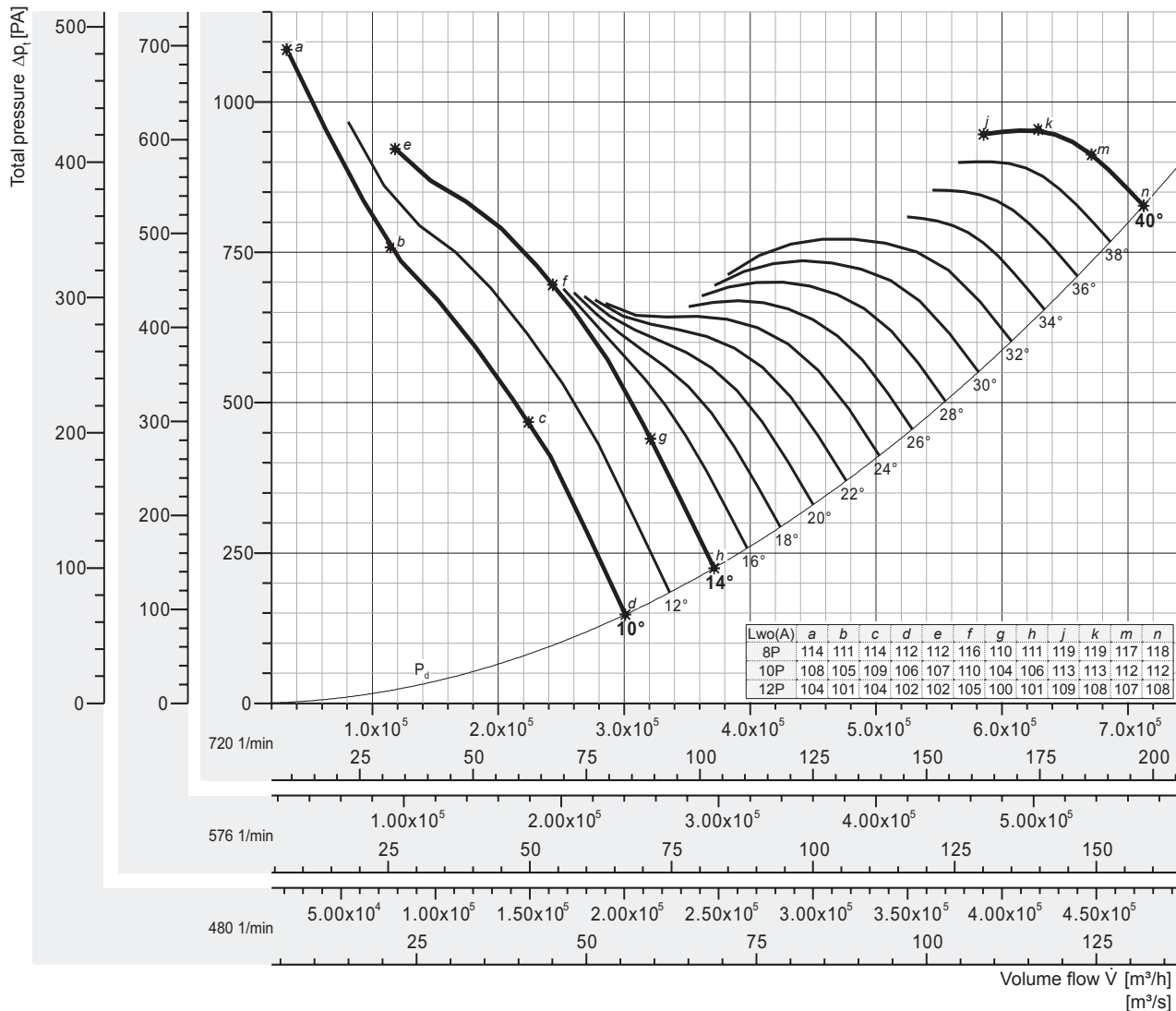
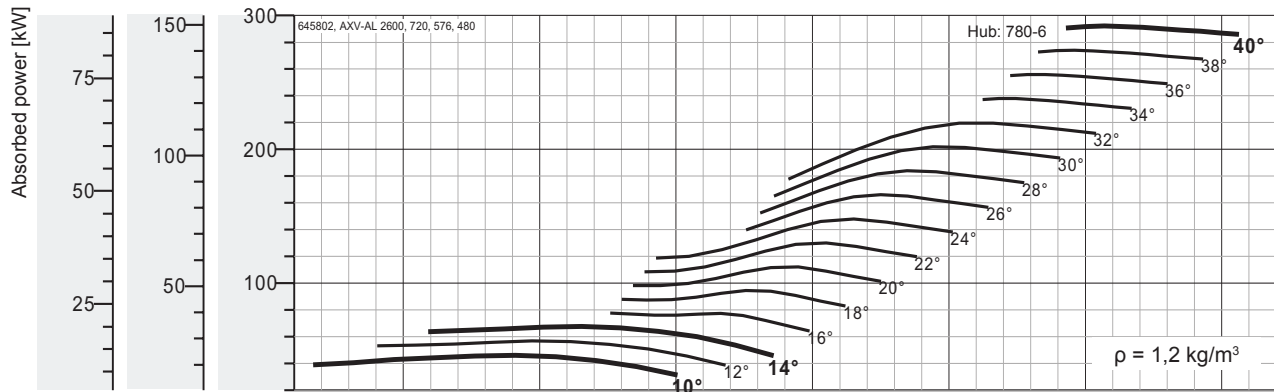

Peak absorbed power [kW]

n [min ⁻¹]	Pitch angle [°]																
	8	10	12	14	16	18	20	22	24	26	28	30	32	34	36	38	40
480 motor	-	13,6	16,8	20,0	23,0	28,0	33,2	38,5	43,9	49,2	54,5	59,8	65,1	70,5	75,8	81,2	86,5
576 motor	-	23,5	29,0	34,6	39,8	48,3	57,3	66,6	75,8	85,0	94,2	103,3	112,4	121,8	131,1	140,3	149,5
720 motor	-	46,0	56,7	67,6	77,6	94,4	112,0	130,1	148,1	166,0	184,0	201,8	219,6	237,9	255,9	274,0	292,1

Fan test laboratory AMCA 210/99 Fig.15, Test Chamber. Performance certified is for installation type A - Free inlet, Free outlet. Performance ratings do not include the effects of appurtenances (accessories-belt cover, pulley & belt).

The A-weighted sound ratings shown have been calculated per AMCA International Standard 301. Values shown are for outlet LwoA sound power levels for installation Type A: free inlet, free outlet.



Performance Curve

AXV 2800, 50 Hz

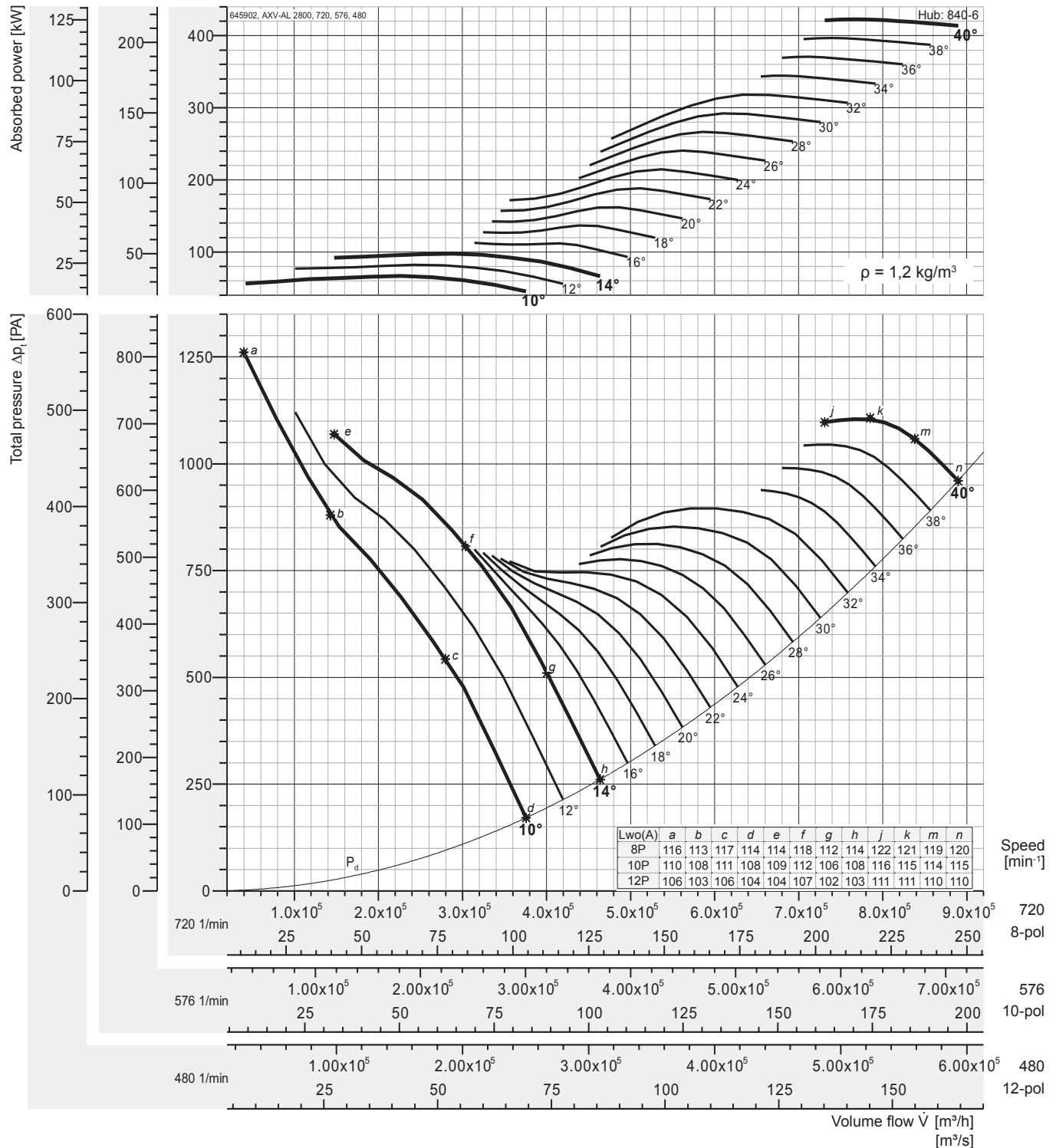

Peak absorbed power [kW]

n [min ⁻¹]	Pitch angle [°]																
	8	10	12	14	16	18	20	22	24	26	28	30	32	34	36	38	40
480 motor	-	19,7	24,3	29,0	33,3	40,5	48,0	55,8	63,5	71,2	78,9	86,6	94,2	102,1	109,8	117,6	125,3
		22	30		37	45	55	75			90		110			132	
576 motor	-	34,1	42,0	50,1	57,6	70,0	83,0	96,4	109,8	123,1	136,4	149,6	162,8	176,4	189,8	203,1	216,5
		37	45	55	75		90	110		132	160		200			250	
720 motor	-	66,6	82,1	97,9	112,4	136,6	162,1	188,3	214,4	240,4	266,4	292,2	318,0	344,5	370,6	396,8	422,9
		75	90	110	132	160	200		250		315		355		450		

Fan test laboratory AMCA 210/99 Fig. 15, Test Chamber. Performance certified is for installation type A - Free inlet, Free outlet. Performance ratings do not include the effects of appurtenances (accessories-belt cover, pulley & belt).

The A-weighted sound ratings shown have been calculated per AMCA International Standard 301. Values shown are for outlet LwoA sound power levels for installation Type A: free inlet, free outlet.

Sound power frequency spectrum L_{wrel} Page 54-55

Dimensions + Accessories Page 49-52

AMCA - FEG rating

Fan Efficiency Grade - AXV



Certified FEGs are determined in accordance with AMCA 205-12 Energy Efficiency Classification for fans. In conjunction with AMCA 211-05 (Rev. 6/12) Certified Ratings Program, Product Rating Manual for Fan Air Performance. This classification is based on fan peak (optimum) total efficiency for a given fan speed, fan size and application category. For the purpose of energy classification, the peak efficiency can be determined at a speed not higher than the maximum design speed of the fan.

The AMCA Certified Ratings Seal applies to the Fan Efficiency Grade (FEG) for AXV series Axial Fan model AXV 355 to AXV 2800 as shown in the table below.

Fan Model No.	Fan Speed (rpm)	Fan Outlet Area (m2)	Fan Efficiency Grades (FEG)	Fan Model No.	Fan Speed (rpm)	Fan Outlet Area (m2)	Fan Efficiency Grade (FEG)
AXV 355	3456/1728/1152	0,1012	FEG63	AXV 1250	1728/1152/864	1,2272	FEG71
AXV 400	3456/1728/1152	0,1269	FEG67	AXV 1400	1152/864/691	1,5504	FEG75
AXV 450	3456/1728/1152	0,1590	FEG63	AXV 1600	1152/864/691	1,9981	FEG67
AXV 500	3456/1728/1152	0,2003	FEG71	AXV 1800	1152/864/691	2,5588	FEG75
AXV 560	3456/1728/1152	0,2516	FEG67	AXV 2000	1152/864/691	3,1573	FEG75
AXV 630	3456/1728/1152	0,3167	FEG63	AXV 2200	864/691/576	3,8186	FEG75
AXV 710	1728/1152/864	0,3982	FEG67	AXV 2400	864/691/576	4,5428	FEG75
AXV 800	1728/1152/864	0,5001	FEG67	AXV 2500	864/691/576	4,9284	FEG75
AXV 900	1728/1152/864	0,6333	FEG63	AXV 2600	864/691/576	5,3297	FEG75
AXV 1000	1728/1152/864	0,7980	FEG71	AXV 2800	864/691/576	6,1795	FEG75
AXV 1120	1728/1152/864	0,9978	FEG71				

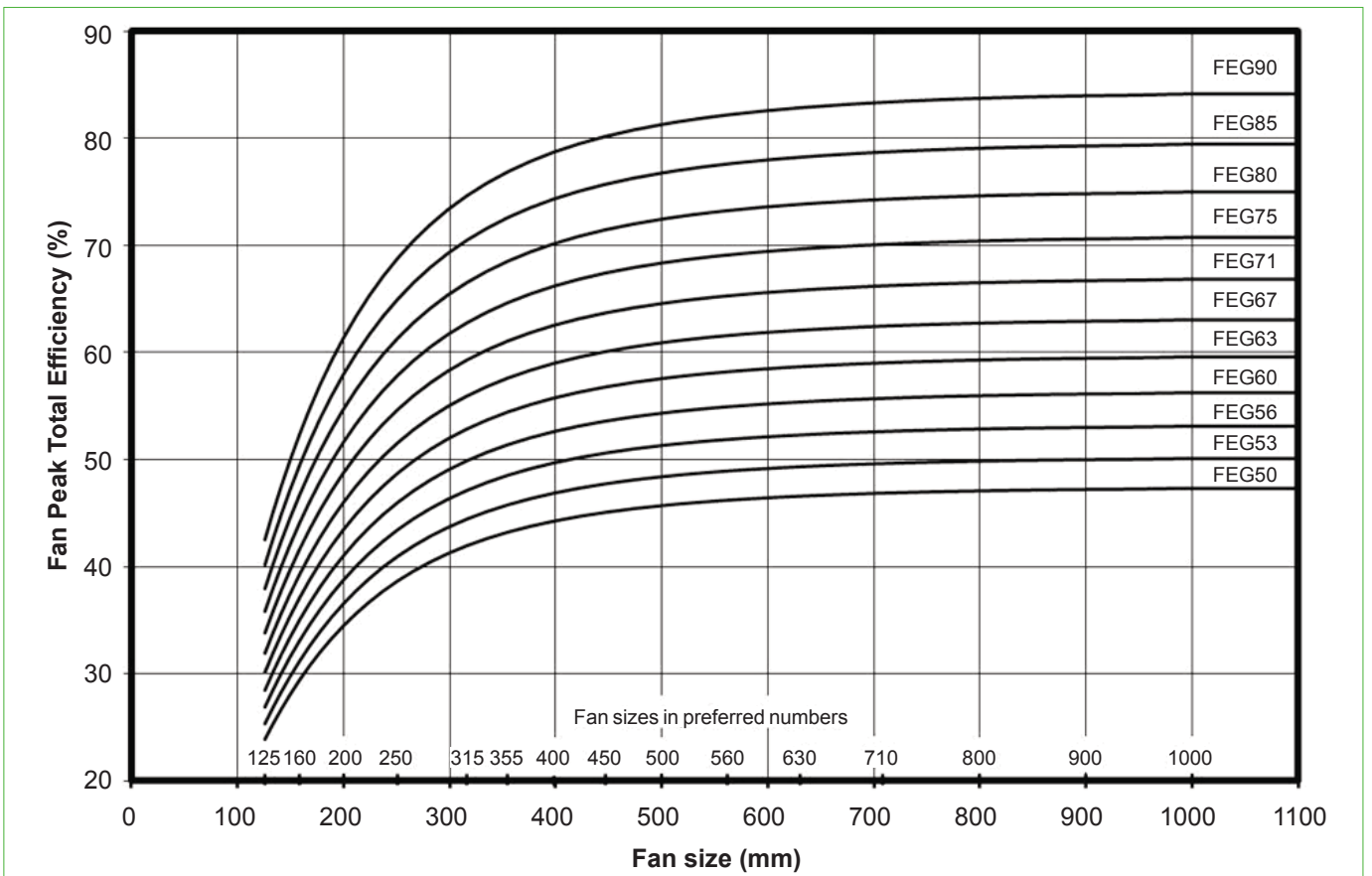



Performance Curve

AXV 355, 60 Hz

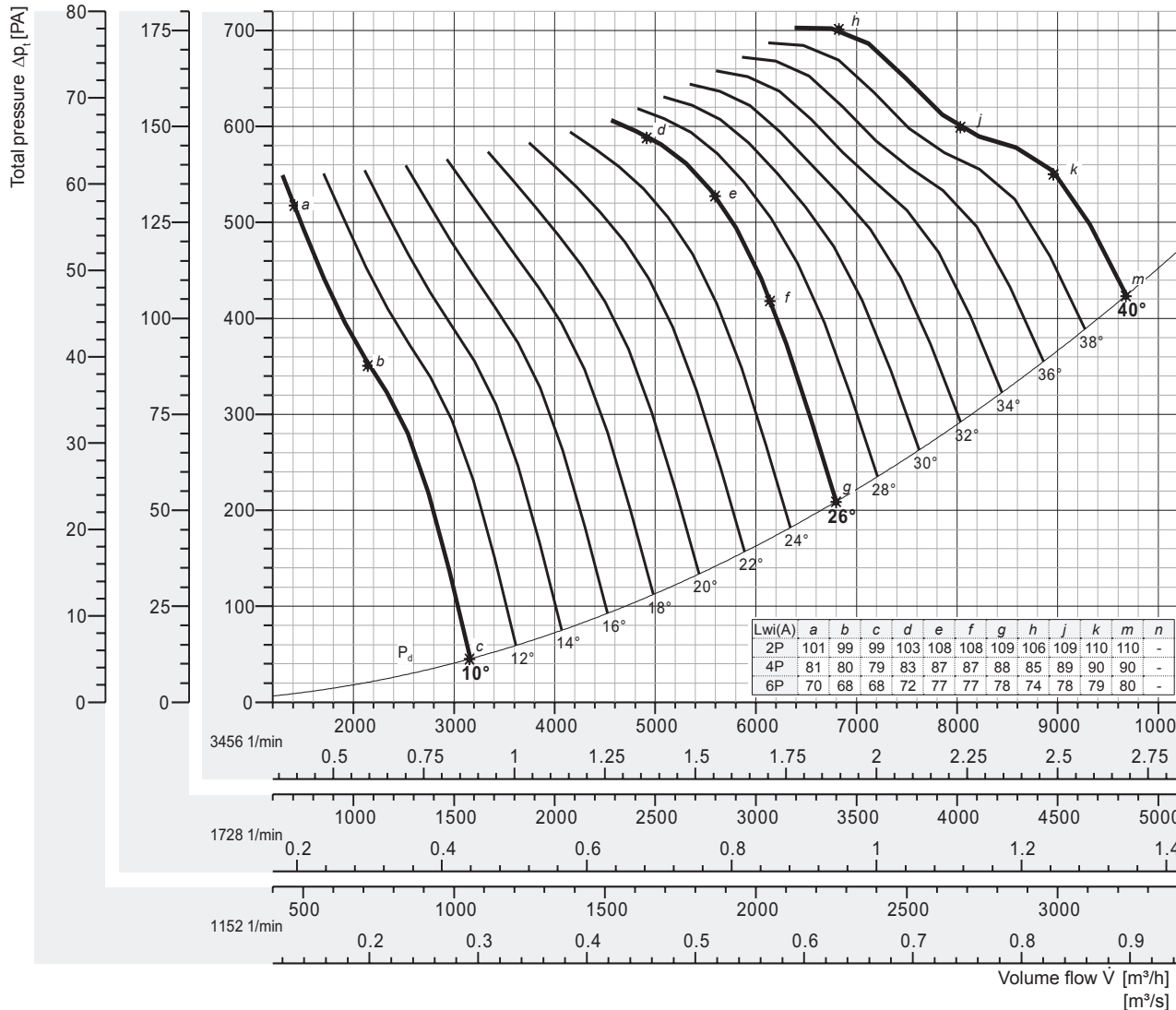
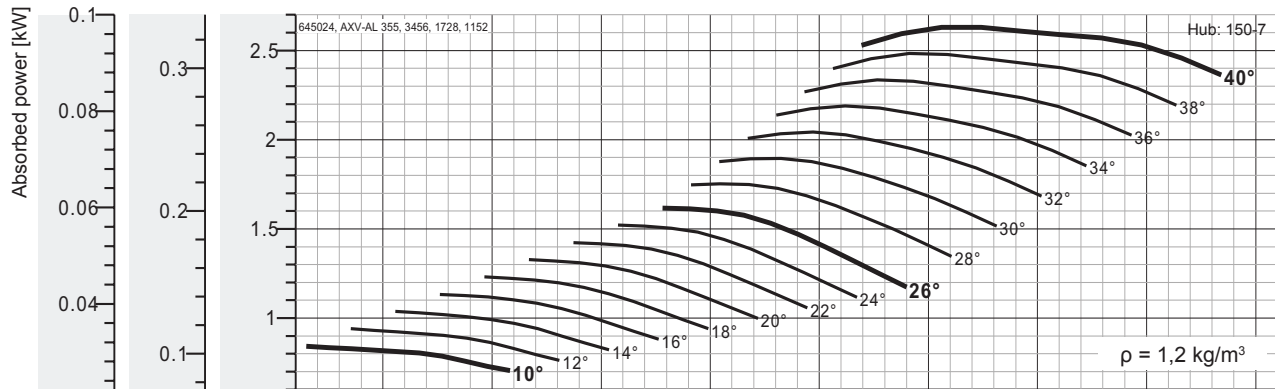

Peak absorbed power [kW]

* Out of Range

n [min ⁻¹]	Pitch angle [°]																
	8	10	12	14	16	18	20	22	24	26	28	30	32	34	36	38	40
1152 motor	-	0,031	0,035	0,038	0,042	0,046	0,049	0,053	0,056	0,060	0,065	0,070	0,076	0,081	0,087	0,092	0,097
		0,37															
1728 motor	-	0,105	0,118	0,130	0,142	0,154	0,166	0,178	0,190	0,202	0,219	0,237	0,255	0,274	0,292	0,310	0,329
		0,37															
3456 motor	-	0,843	0,940	1,04	1,13	1,23	1,33	1,42	1,52	1,62	1,75	1,90	2,04	2,19	2,34	2,48	2,63
		1,1			1,5			2,2							-*		

Fan test laboratory AMCA 210/99 Fig.12, Test Chamber. Performance certified is for installation type D - Ducted inlet, Ducted outlet. Performance ratings do not include the effects of appurtenances (accessories-belt cover, pulley & belt).

The A-weighted sound ratings shown have been calculated per AMCA International Standard 301. Values shown are for inlet Lw(A) sound power levels for installation Type D: ducted inlet, ducted outlet. Ratings include the effects of duct end correction.

Sound power frequency spectrum L_{wrel} Page 54-55

Dimensions + Accessories Page 49-52

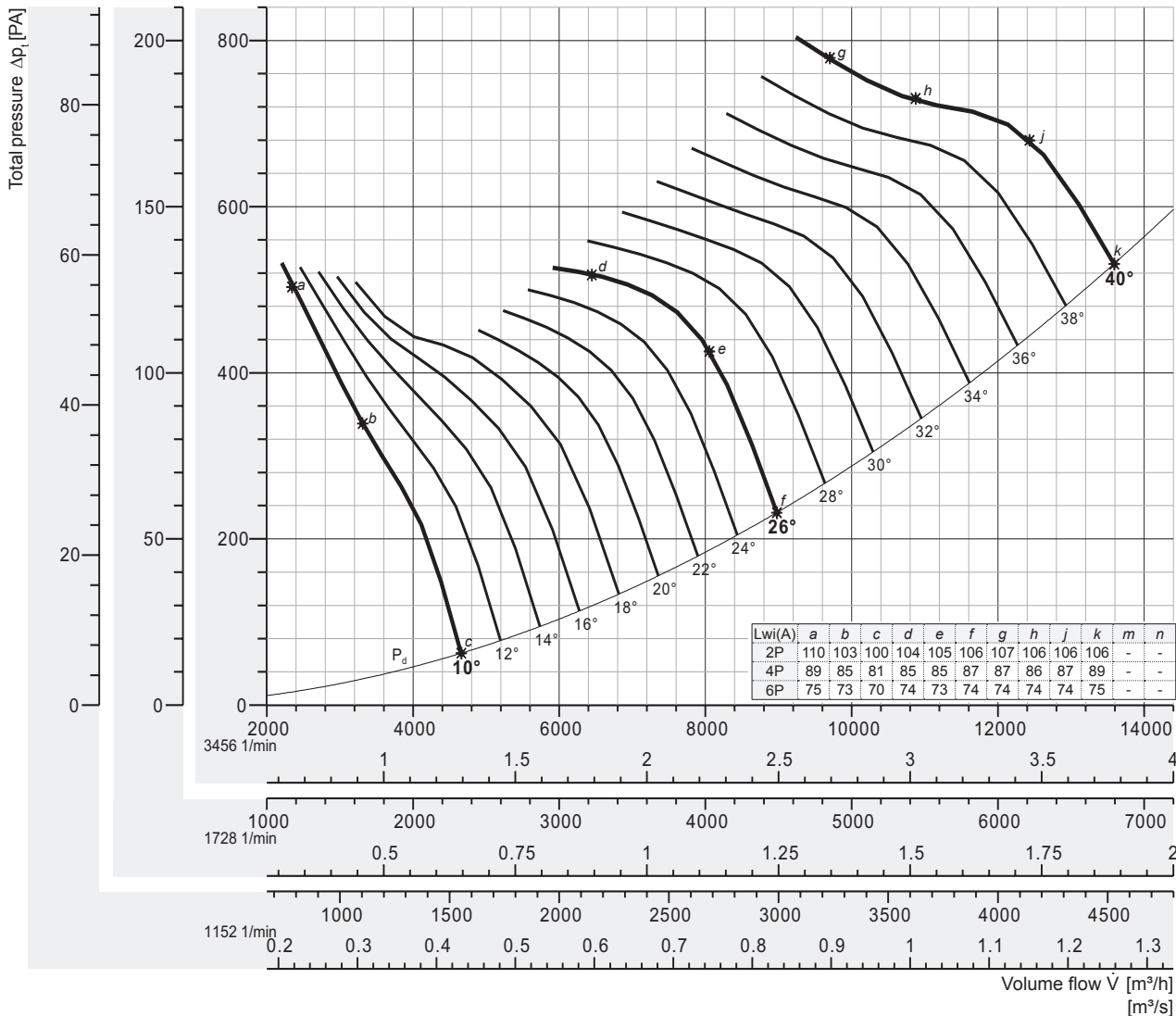
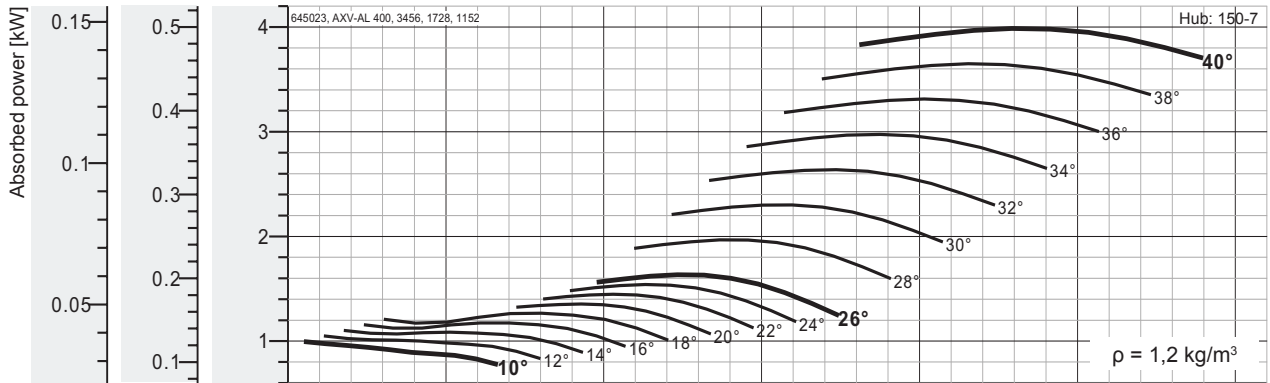

Speed
[min⁻¹]

3456
2-pol

1728
4-pol

1152
6-pol

Peak absorbed power [kW]

n [min ⁻¹]	Pitch angle [°]																
	8	10	12	14	16	18	20	22	24	26	28	30	32	34	36	38	40
1152 motor	-	0,037	0,039	0,041	0,043	0,047	0,050	0,054	0,057	0,061	0,073	0,085	0,098	0,110	0,123	0,135	0,148
1728 motor	-	0,124	0,131	0,138	0,147	0,158	0,169	0,181	0,193	0,204	0,246	0,288	0,330	0,372	0,414	0,456	0,498
3456 motor	-	0,995	1,05	1,10	1,17	1,27	1,35	1,45	1,54	1,63	1,97	2,30	2,64	2,98	3,31	3,65	3,99

Fan test laboratory AMCA 210/99 Fig.12, Test Chamber. Performance certified is for installation type D - Ducted inlet, Ducted outlet. Performance ratings do not include the effects of appurtenances (accessories-belt cover, pulley & belt).

The A-weighted sound ratings shown have been calculated per AMCA International Standard 301. Values shown are for inlet LwiA sound power levels for installation Type D: ducted inlet, ducted outlet. Ratings include the effects of duct end correction.

Sound power frequency spectrum L_{wref} Page 54-55

Dimensions + Accessories Page 49-52

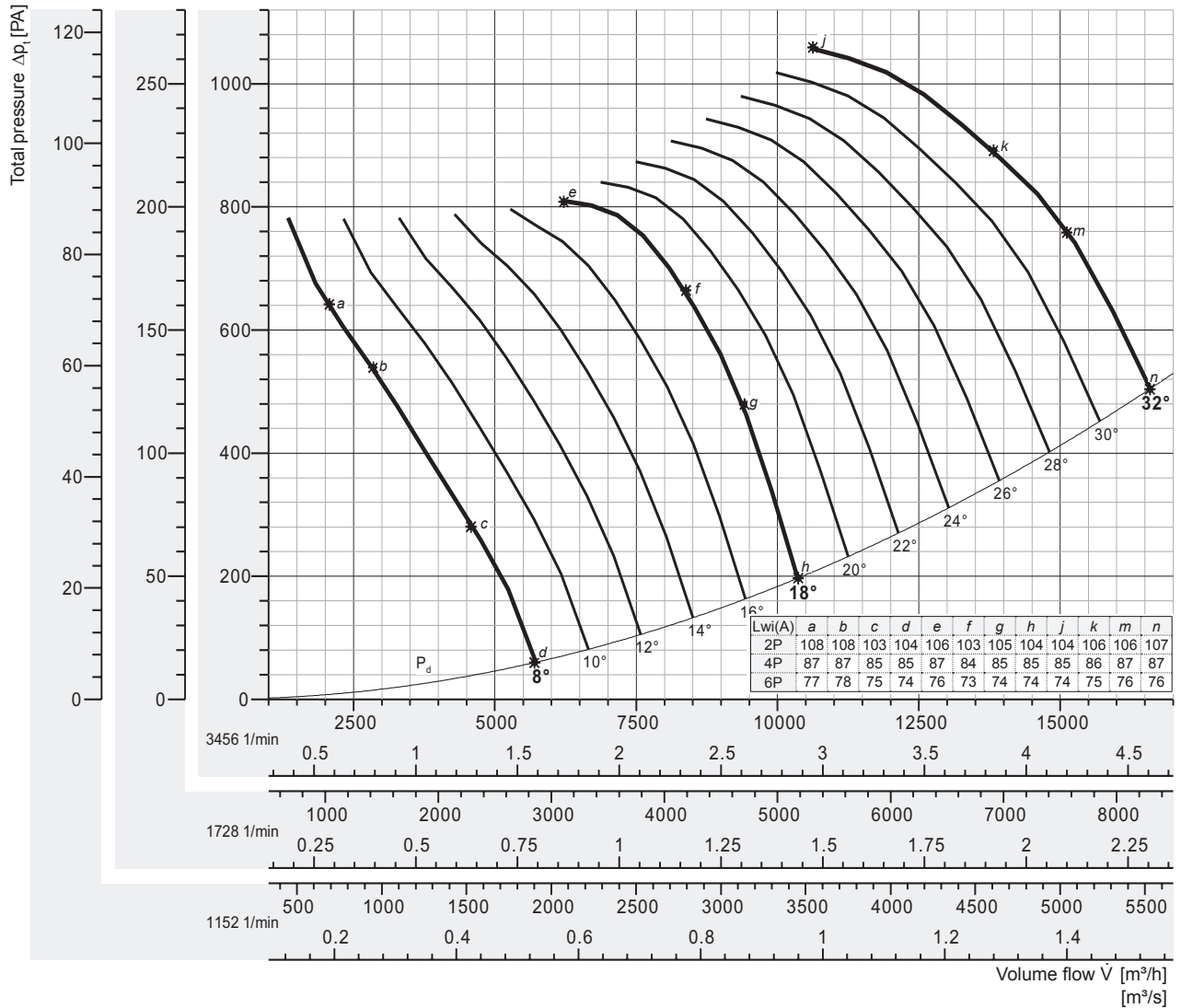
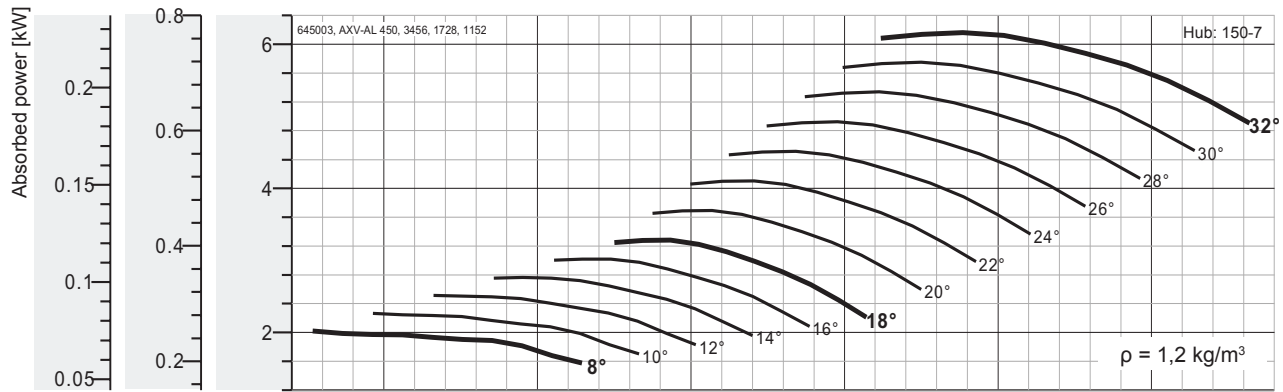

Peak absorbed power [kW]

* Out of Range

n [min ⁻¹]	Pitch angle [°]																
	8	10	12	14	16	18	20	22	24	26	28	30	32	34	36	38	40
1152 motor	0,075	0,084	0,093	0,102	0,112	0,121	0,137	0,152	0,167	0,182	0,198	0,213	0,228	-	-	-	-
	0,37																
1728 motor	0,252	0,283	0,314	0,345	0,377	0,410	0,461	0,513	0,564	0,616	0,667	0,719	0,770	-	-	-	-
	0,37				0,55				0,75			1,1					
3456 motor	2,02	2,26	2,51	2,76	3,02	3,28	3,69	4,10	4,52	4,93	5,34	5,75	6,16	-	-	-	-
	2,2	3			4			-*									

Fan test laboratory AMCA 210/99 Fig.12, Test Chamber. Performance certified for installation type D - Ducted inlet, Ducted outlet. Performance ratings do not include the effects of appurtenances (accessories-belt cover, pulley & belt).

Sound power frequency spectrum L_{wrel} Page 54-55

The A-weighted sound ratings shown have been calculated per AMCA International Standard 301. Values shown are for inlet LwA sound power levels for installation Type D: ducted inlet, ducted outlet. Ratings include the effects of duct end correction.

Dimensions + Accessories Page 49-52

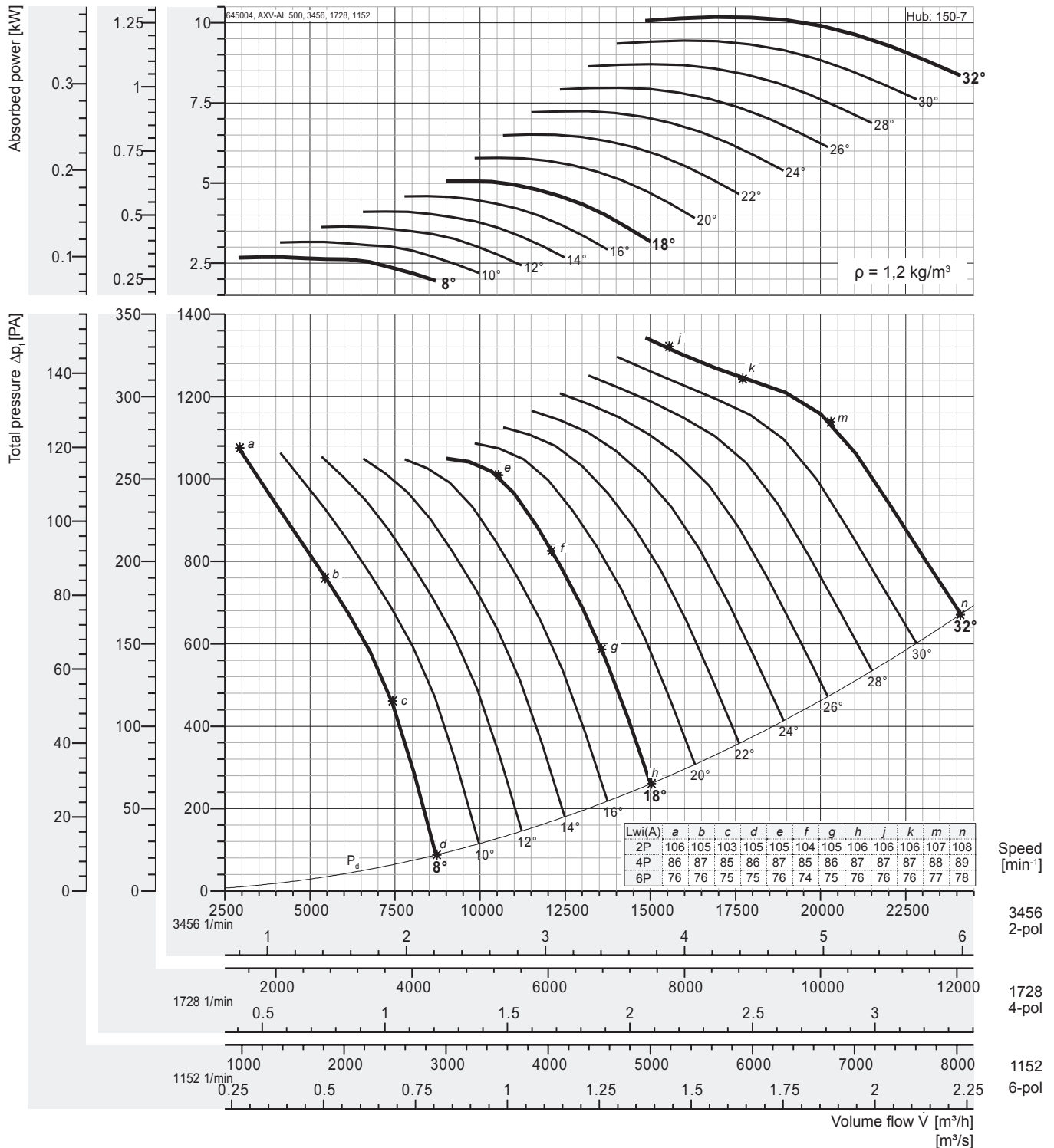

Peak absorbed power [kW]

* Out of Range

n [min ⁻¹]	Pitch angle [°]																
	8	10	12	14	16	18	20	22	24	26	28	30	32	34	36	38	40
1152 motor	0,099	0,117	0,135	0,152	0,170	0,187	0,214	0,241	0,268	0,295	0,322	0,350	0,377	-	-	-	-
	0,37												0,55				
1728 motor	0,336	0,395	0,454	0,514	0,573	0,633	0,723	0,814	0,905	0,997	1,09	1,18	1,27	-	-	-	-
	0,37	0,55			0,75			1,1				1,5					
3456 motor	2,69	3,16	3,64	4,11	4,59	5,06	5,79	6,51	7,24	7,97	8,71	9,44	10,2	-	-	-	-
	3	4		-*													

Fan test laboratory AMCA 210/99 Fig.12, Test Chamber. Performance certified is for installation type D - Ducted inlet, Ducted outlet. Performance ratings do not include the effects of appurtenances (accessories-belt cover, pulley & belt).

Sound power frequency spectrum L_{wref} Page 54-55

The A-weighted sound ratings shown have been calculated per AMCA International Standard 301. Values shown are for inlet LwA sound power levels for installation Type D: ducted inlet, ducted outlet. Ratings include the effects of duct end correction.

Dimensions + Accessories Page 49-52



Performance Curve

AXV 560, 60 Hz

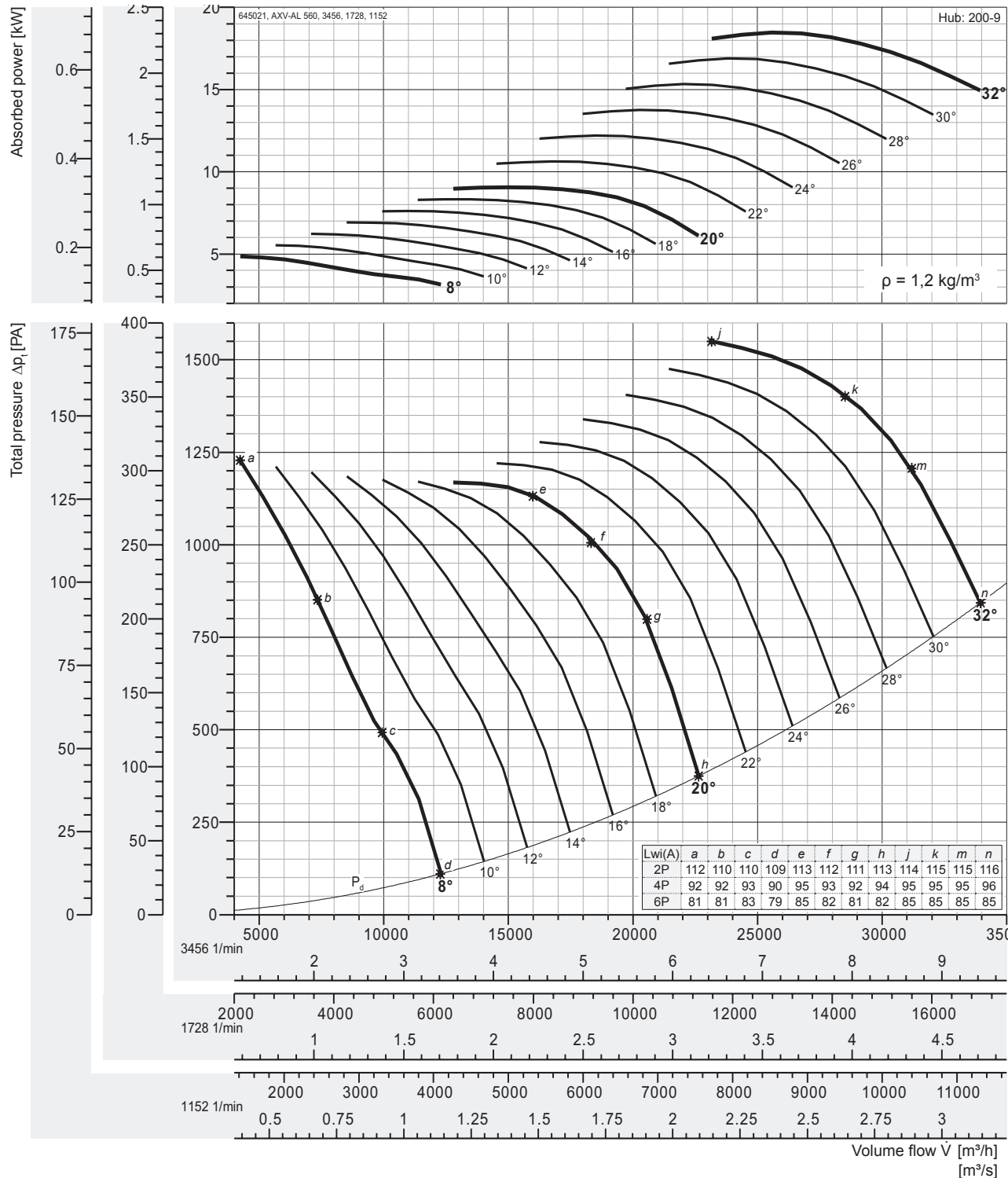

Peak absorbed power [kW]

n [min ⁻¹]	Pitch angle [°]																
	8	10	12	14	16	18	20	22	24	26	28	30	32	34	36	38	40
1152 motor	0,180	0,205	0,231	0,256	0,282	0,308	0,336	0,394	0,452	0,510	0,568	0,626	0,684	-	-	-	-
	0,37							0,55			0,75						
1728 motor	0,607	0,692	0,778	0,864	0,952	1,04	1,13	1,33	1,52	1,72	1,92	2,11	2,31	-	-	-	-
	0,75		1,1				1,5		2,2			3					
3456 motor	4,85	5,54	6,23	6,91	7,61	8,33	9,06	10,6	12,2	13,8	15,3	16,9	18,4	-	-	-	-
	5,5	7,5			11				15		18,5						

Fan test laboratory AMCA 210/99 Fig.12, Test Chamber. Performance certified is for installation type D - Ducted inlet, Ducted outlet. Performance ratings do not include the effects of appurtenances (accessories-belt cover, pulley & belt).

Sound power frequency spectrum L_{wrel} Page 54-55

The A-weighted sound ratings shown have been calculated per AMCA International Standard 301. Values shown are for inlet LwA sound power levels for installation Type D: ducted inlet, ducted outlet. Ratings include the effects of duct end correction.

Dimensions + Accessories Page 49-52

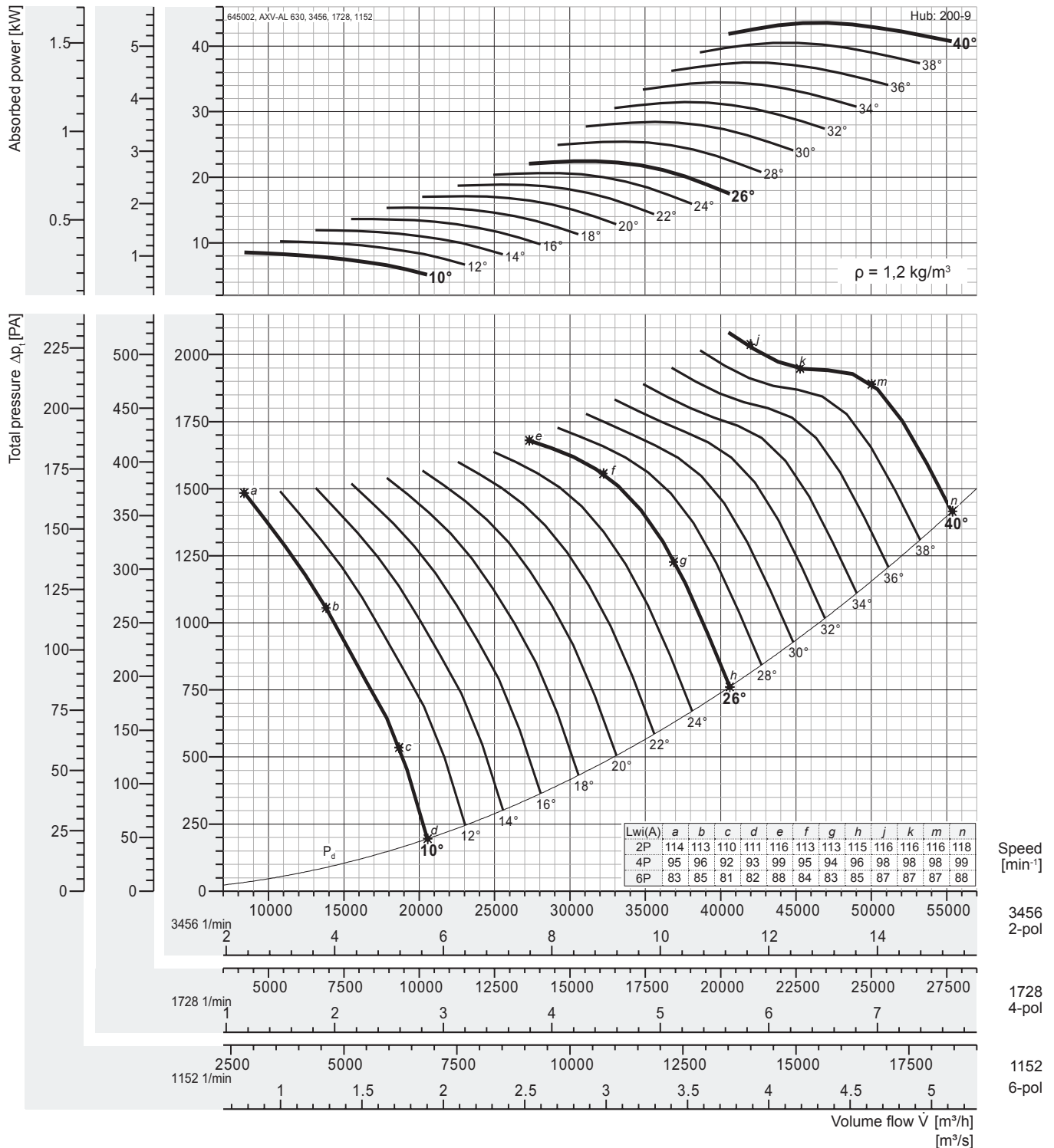

Peak absorbed power [kW]

* Out of Range

n [min ⁻¹]	Pitch angle [°]																
	8	10	12	14	16	18	20	22	24	26	28	30	32	34	36	38	40
1152 motor	-	0,316	0,379	0,442	0,505	0,568	0,624	0,699	0,765	0,831	0,942	1,05	1,17	1,28	1,39	1,50	1,63
		0,37	0,55			0,75			1,1				1,5				2,2
1728 motor	-	1,07	1,28	1,49	1,70	1,92	2,14	2,36	2,58	2,80	3,18	3,56	3,93	4,31	4,69	5,06	5,44
		1,1	1,5		2,2			3		4			5,5				
3456 motor	-	8,54	10,2	11,9	13,6	15,3	17,1	18,9	20,7	22,4	25,4	28,5	31,5	34,5	37,5	40,5	43,6
		11		15		18,5		-*									

Fan test laboratory AMCA 210/99 Fig.12, Test Chamber. Performance certified is for installation type D - Ducted inlet, Ducted outlet. Performance ratings do not include the effects of appurtenances (accessories-belt cover, pulley & belt).

Sound power frequency spectrum L_{wref} Page 54-55

The A-weighted sound ratings shown have been calculated per AMCA International Standard 301. Values shown are for inlet Lw(A) sound power levels for installation Type D: ducted inlet, ducted outlet. Ratings include the effects of duct end correction.

Dimensions + Accessories Page 49-52



Performance Curve

AXV 710, 60 Hz

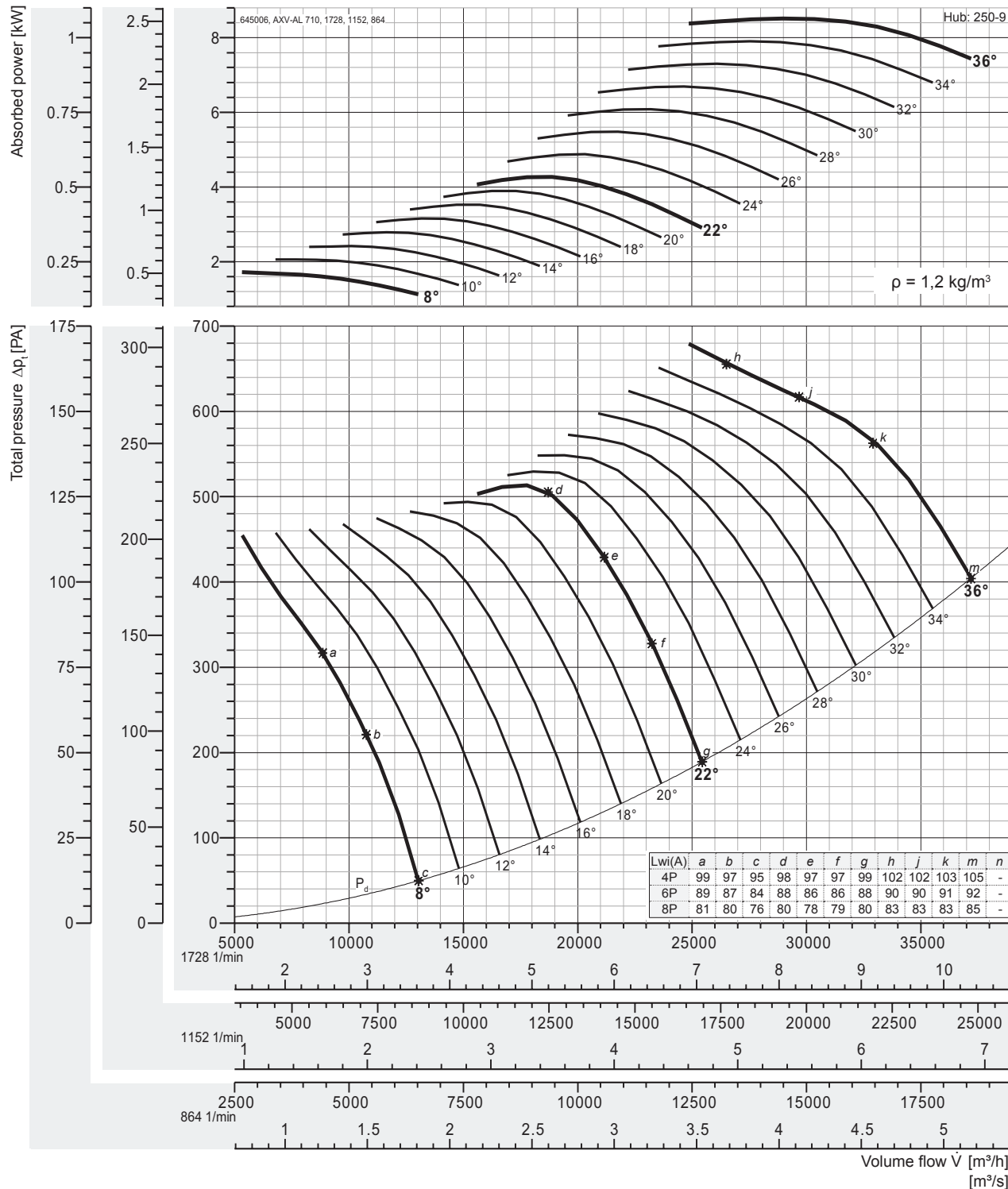

Peak absorbed power [kW]

n [min ⁻¹]	Pitch angle [°]																
	8	10	12	14	16	18	20	22	24	26	28	30	32	34	36	38	40
864 motor	0,215	0,257	0,302	0,348	0,394	0,441	0,487	0,534	0,610	0,685	0,761	0,837	0,912	0,988	1,06	-	-
	0,37				0,55				0,75		1,1						
1152 motor	0,510	0,609	0,715	0,825	0,935	1,04	1,15	1,27	1,45	1,62	1,80	1,98	2,16	2,34	2,52	-	-
	0,55	0,75		1,1		1,5			2,2		3						
1728 motor	1,72	2,06	2,41	2,78	3,15	3,52	3,90	4,27	4,88	5,48	6,09	6,69	7,30	7,91	8,51	-	-
	2,2		3		4		5,5			7,5		11					

Fan test laboratory AMCA 210/99 Fig.12, Test Chamber. Performance certified is for installation type D - Ducted inlet, Ducted outlet. Performance ratings do not include the effects of appurtenances (accessories-belt cover, pulley & belt).

Sound power frequency spectrum L_{wrel} Page 54-55

The A-weighted sound ratings shown have been calculated per AMCA International Standard 301. Values shown are for inlet LwA sound power levels for installation Type D: ducted inlet, ducted outlet. Ratings include the effects of duct end correction.

Dimensions + Accessories Page 49-52

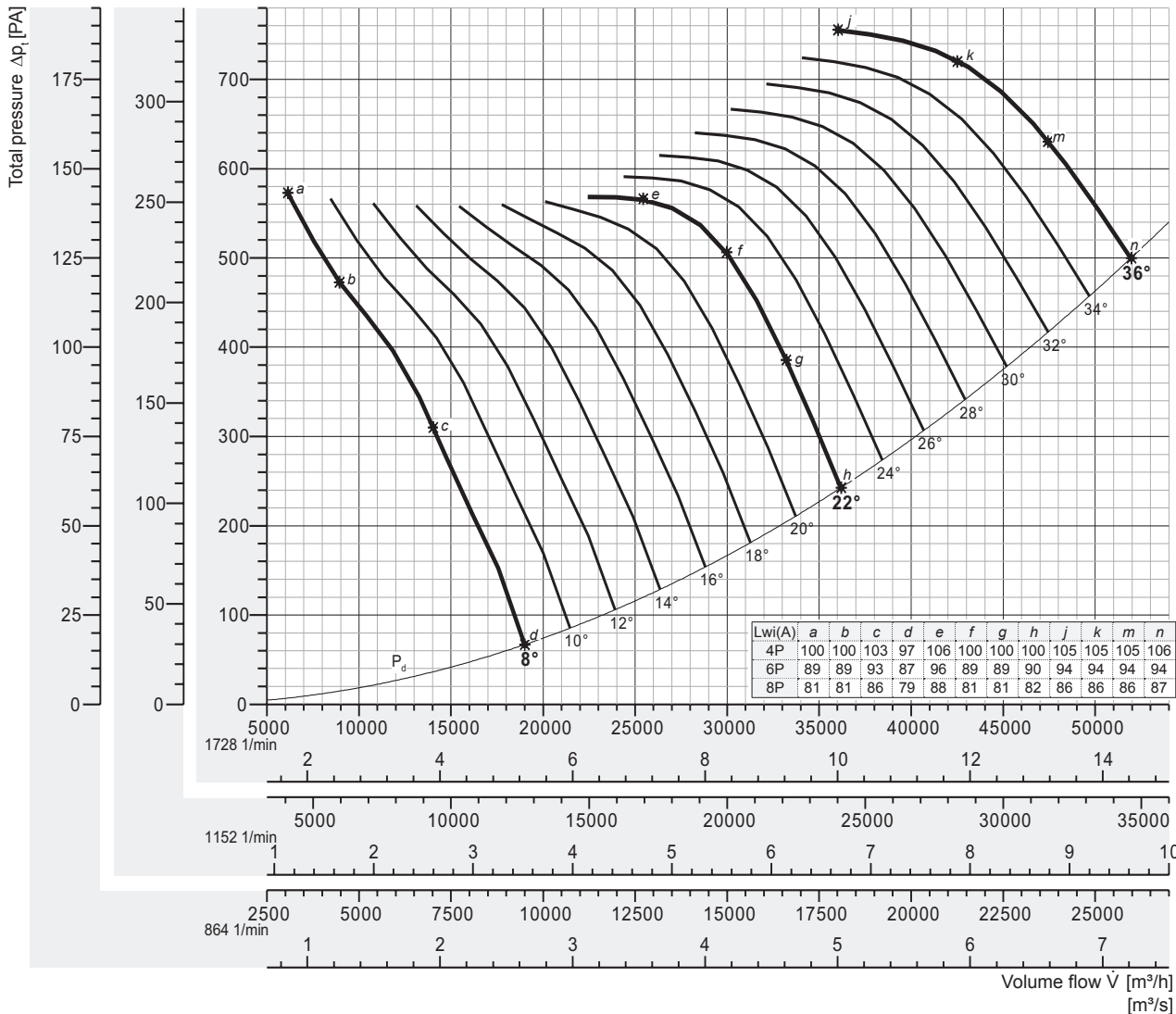
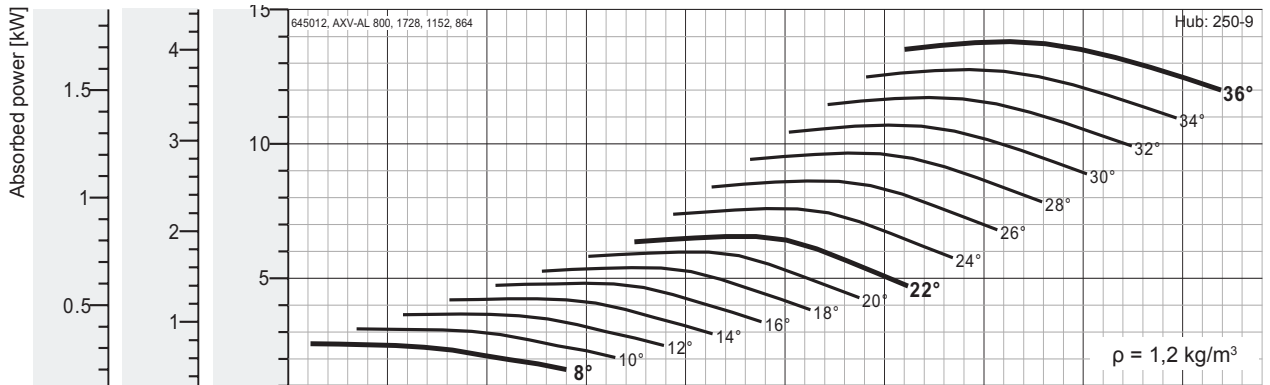

Speed [min⁻¹]
1728
4-pol
1152
6-pol
864
8-pol

Peak absorbed power [kW]

n [min ⁻¹]	Pitch angle [°]																
	8	10	12	14	16	18	20	22	24	26	28	30	32	34	36	38	40
864 motor	0,321	0,388	0,458	0,529	0,602	0,674	0,747	0,820	0,949	1,08	1,21	1,34	1,47	1,60	1,73	-	-
	0,37	0,55			0,75			1,1			1,5			2,2			
1152 motor	0,761	0,921	1,08	1,26	1,43	1,60	1,77	1,94	2,25	2,56	2,86	3,17	3,48	3,78	4,09	-	-
	1,1			1,5		2,2		3			4			5,5			
1728 motor	2,57	3,11	3,66	4,23	4,81	5,39	5,97	6,56	7,59	8,63	9,66	10,7	11,7	12,8	13,8	-	-
	3	4		5,5			7,5		11			15					

Fan test laboratory AMCA 210/99 Fig.12, Test Chamber. Performance certified is for installation type D - Ducted inlet, Ducted outlet. Performance ratings do not include the effects of appurtenances (accessories-belt cover, pulley & belt).

Sound power frequency spectrum L_{wref} Page 54-55

The A-weighted sound ratings shown have been calculated per AMCA International Standard 301. Values shown are for inlet Lw_iA sound power levels for installation Type D: ducted inlet, ducted outlet. Ratings include the effects of duct end correction.

Dimensions + Accessories Page 49-52



Performance Curve

AXV 900, 60 Hz

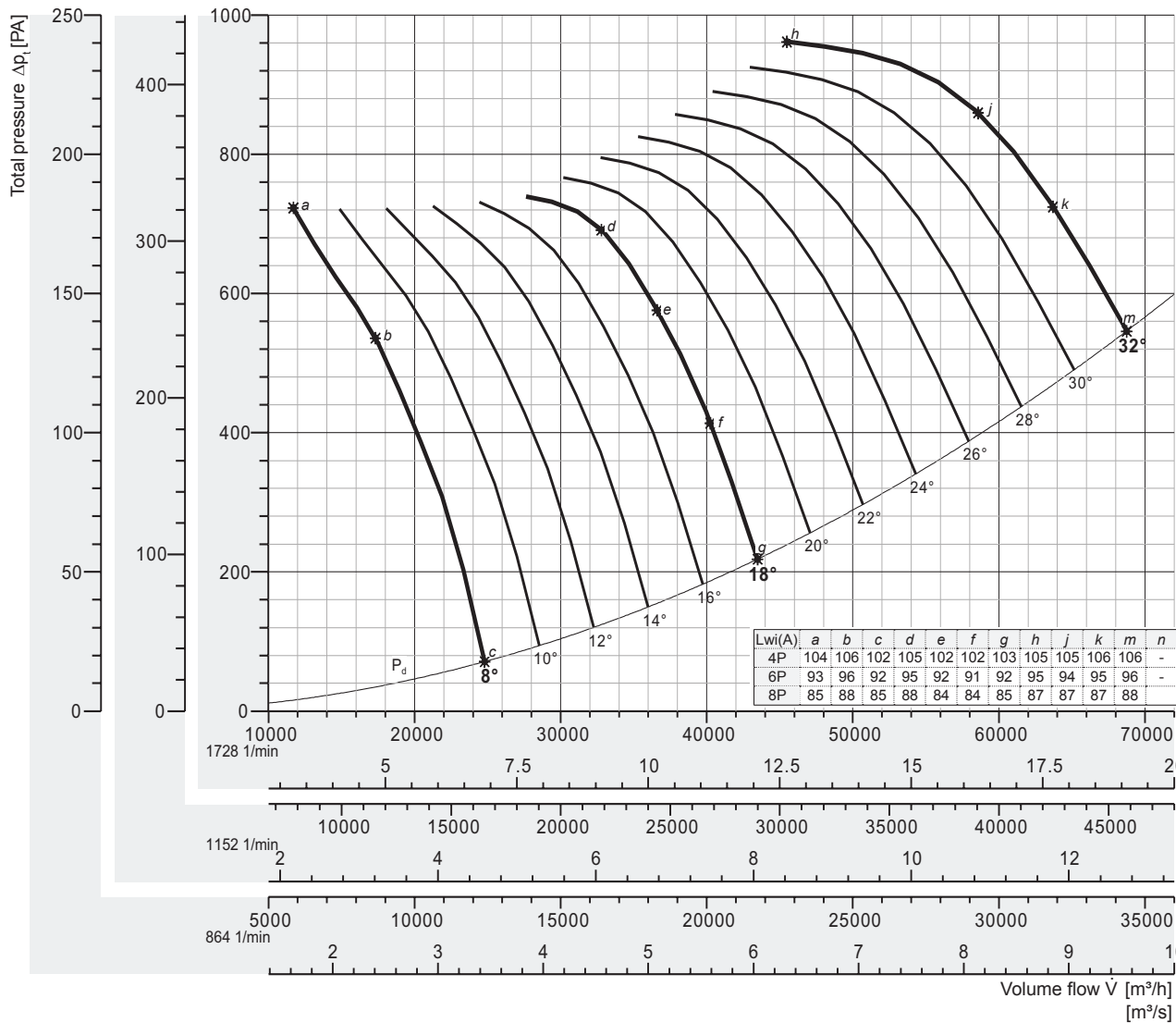
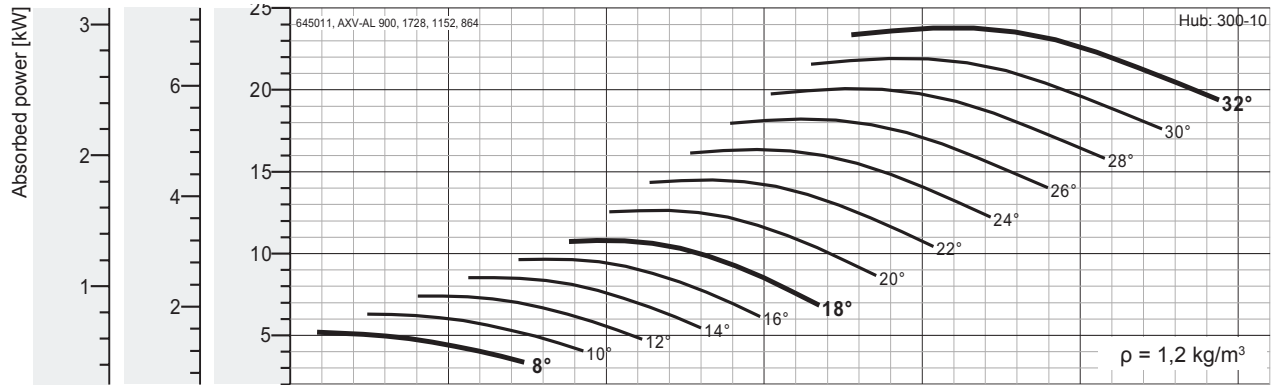

Speed [min⁻¹]
 1728 4-pol
 1152 6-pol
 864 8-pol

Peak absorbed power [kW]

* Out of Range

n [min ⁻¹]	Pitch angle [°]																
	8	10	12	14	16	18	20	22	24	26	28	30	32	34	36	38	40
864 motor	0,649	0,787	0,926	1,07	1,21	1,35	1,58	1,81	2,04	2,28	2,51	2,74	2,97	-	-	-	-
	0,75	1,1			1,5		2,2			3							
1152 motor	1,54	1,87	2,19	2,53	2,86	3,20	3,74	4,29	4,84	5,39	5,95	6,50	7,05	-	-	-	-
	2,2			3		4		5,5		7,5							
1728 motor	5,19	6,30	7,41	8,53	9,66	10,8	12,6	14,5	16,3	18,2	20,1	21,9	23,8	-	-	-	-
	5,5	7,5		11			15		18,5		22		30				

Fan test laboratory AMCA 210/99 Fig.12, Test Chamber. Performance certified for installation type D - Ducted inlet, Ducted outlet. Performance ratings do not include the effects of appurtenances (accessories-belt cover, pulley & belt).

The A-weighted sound ratings shown have been calculated per AMCA International Standard 301. Values shown are for inlet Lw(A) sound power levels for installation Type D: ducted inlet, ducted outlet. Ratings include the effects of duct end correction.

Sound power frequency spectrum L_{wref} Page 54-55

Dimensions + Accessories Page 49-52

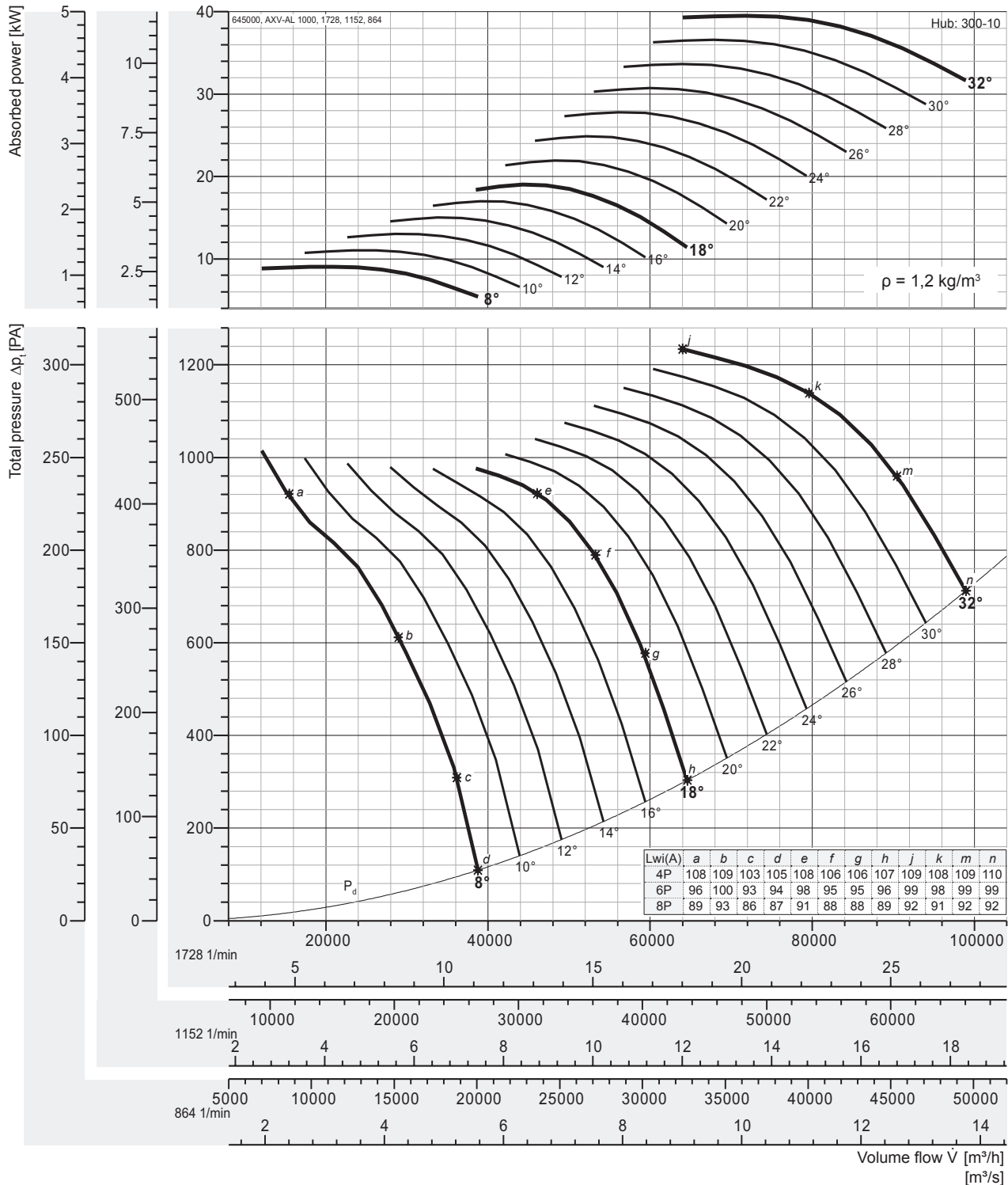

Peak absorbed power [kW]

n [min ⁻¹]	Pitch angle [°]																
	8	10	12	14	16	18	20	22	24	26	28	30	32	34	36	38	40
864 motor	1,13	1,38	1,63	1,88	2,13	2,38	2,74	3,11	3,47	3,84	4,21	4,57	4,94	-	-	-	-
	1,5		2,2			3		4			5,5						
1152 motor	2,68	3,27	3,86	4,45	5,04	5,63	6,50	7,37	8,24	9,10	9,97	10,8	11,7	-	-	-	-
	3	4		5,5		7,5		11			15						
1728 motor	9,05	11,0	13,0	15,0	17,0	19,0	21,9	24,9	27,8	30,7	33,7	36,6	39,5	-	-	-	-
	11		15		18,5	22		30		37		45					

Fan test laboratory AMCA 210/99 Fig.12, Test Chamber. Performance certified is for installation type D - Ducted inlet, Ducted outlet. Performance ratings do not include the effects of appurtenances (accessories-belt cover, pulley & belt).

Sound power frequency spectrum L_{wref} Page 54-55

The A-weighted sound ratings shown have been calculated per AMCA International Standard 301. Values shown are for inlet LwiA sound power levels for installation Type D: ducted inlet, ducted outlet. Ratings include the effects of duct end correction.

Dimensions + Accessories Page 49-52



Performance Curve

AXV 1120, 60 Hz

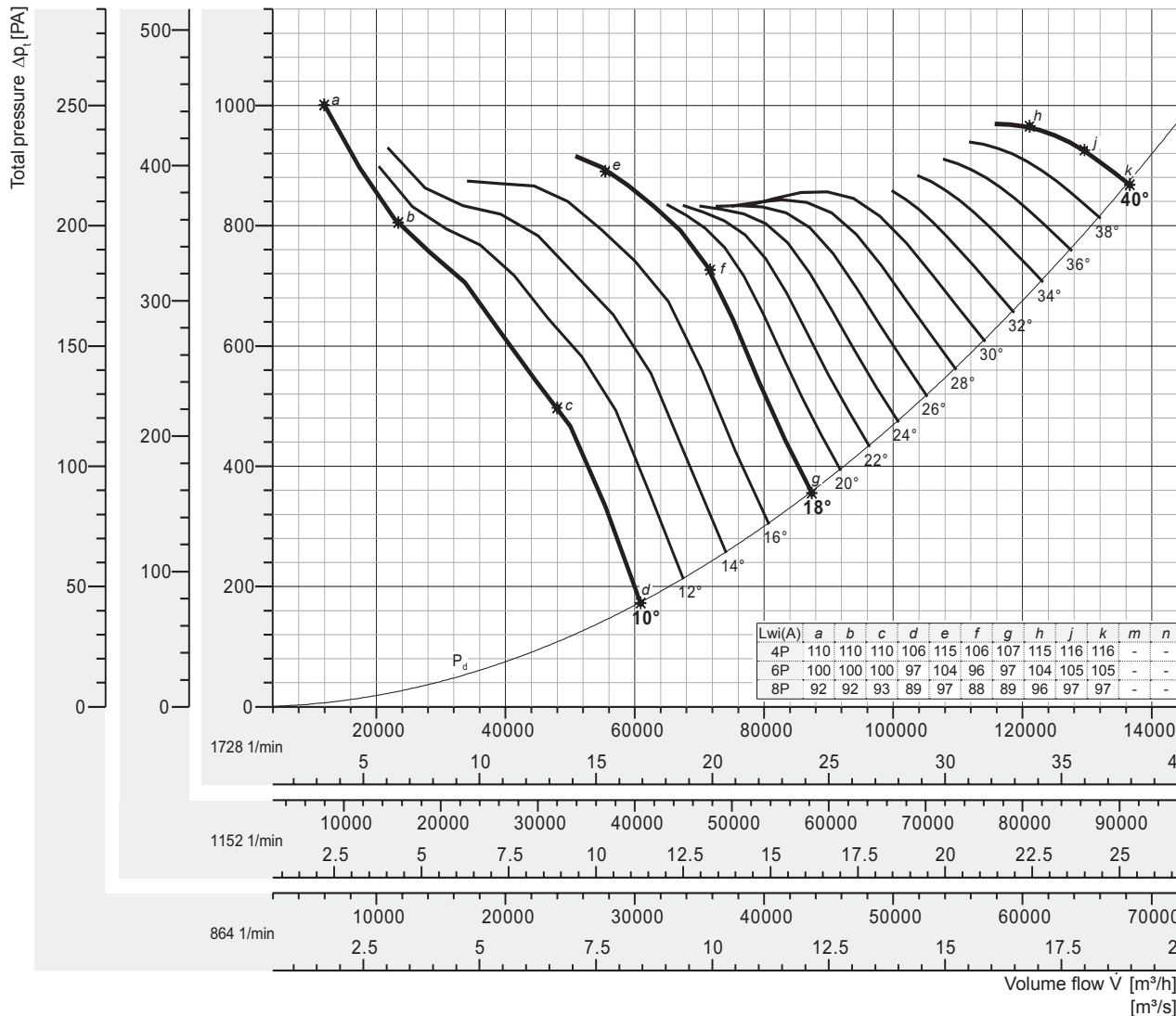
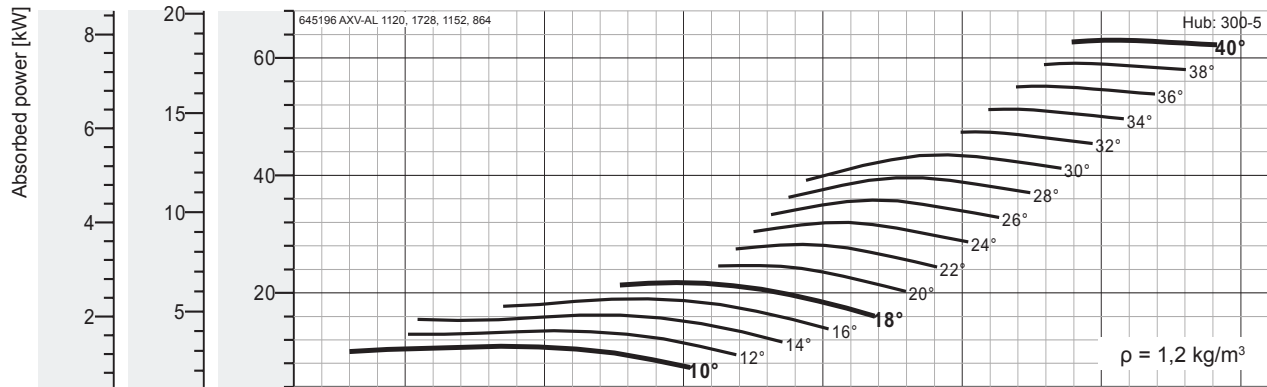

Speed [min⁻¹]
 1728 4-pol
 1152 6-pol
 864 8-pol

Peak absorbed power [kW]

n [min ⁻¹]	Pitch angle [°]																
	8	10	12	14	16	18	20	22	24	26	28	30	32	34	36	38	40
864 motor	-	1,36	1,70	2,03	2,37	2,72	3,08	3,53	4,00	4,48	4,95	5,44	5,93	6,41	6,90	7,39	7,88
		1,5	2,2		3		4			5,5			7,5				11
1152 motor	-	3,23	4,02	4,81	5,62	6,44	7,31	8,37	9,48	10,6	11,7	12,9	14,0	15,2	16,3	17,5	18,7
		4	5,5		7,5			11		15			18,5				22
1728 motor	-	10,9	13,6	16,2	19,0	21,7	24,7	28,3	32,0	35,8	39,6	43,5	47,4	51,3	55,2	59,1	63,0
		11	15	18,5	22		30		37		45		55		75		

Fan test laboratory AMCA 210/99 Fig.12, Test Chamber. Performance certified for installation type D - Ducted inlet, Ducted outlet. Performance ratings do not include the effects of appurtenances (accessories-belt cover, pulley & belt).

Sound power frequency spectrum L_{wrel} Page 54-55

The A-weighted sound ratings shown have been calculated per AMCA International Standard 301. Values shown are for inlet LwA sound power levels for installation Type D: ducted inlet, ducted outlet. Ratings include the effects of duct end correction.

Dimensions + Accessories Page 49-52

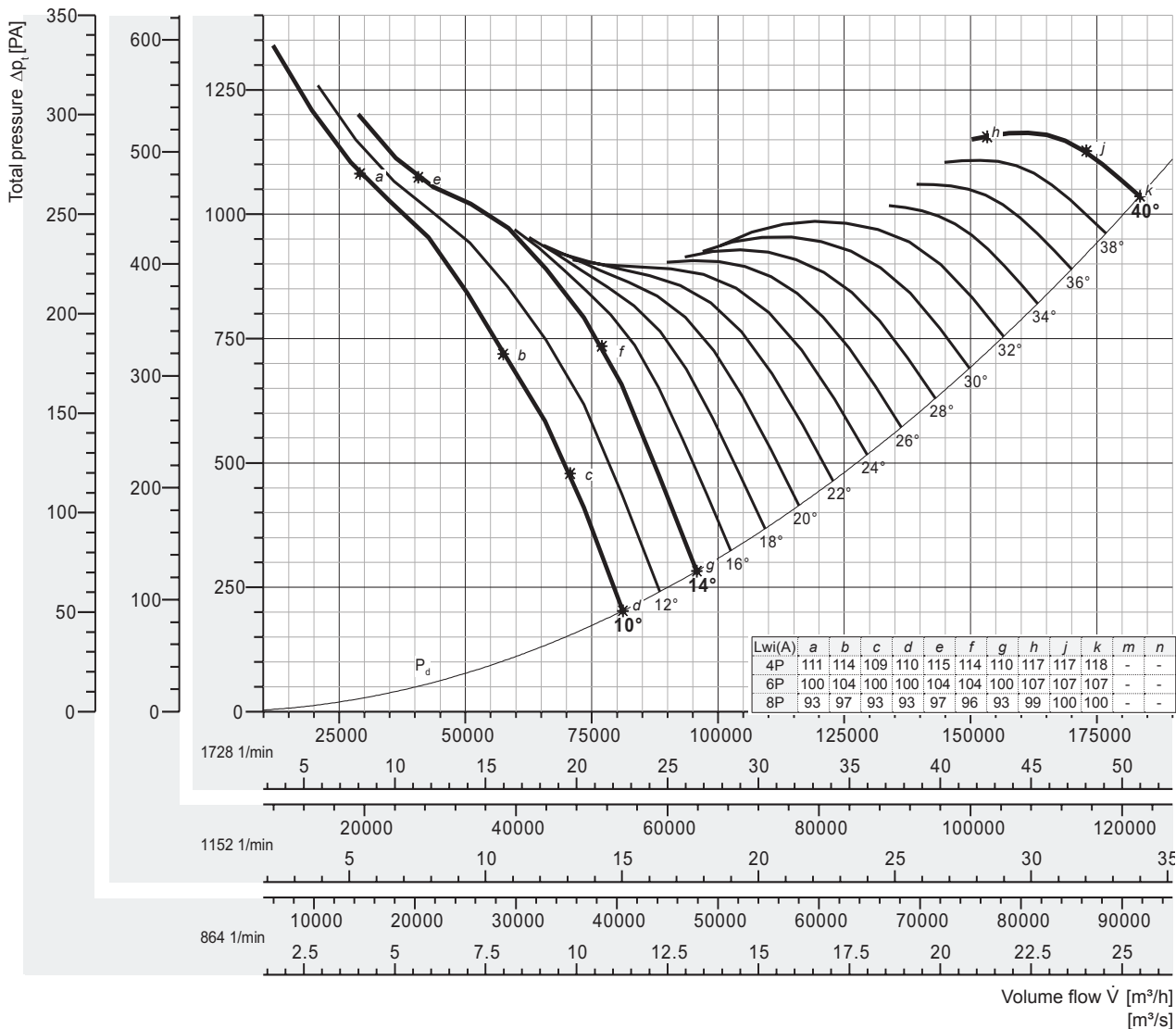
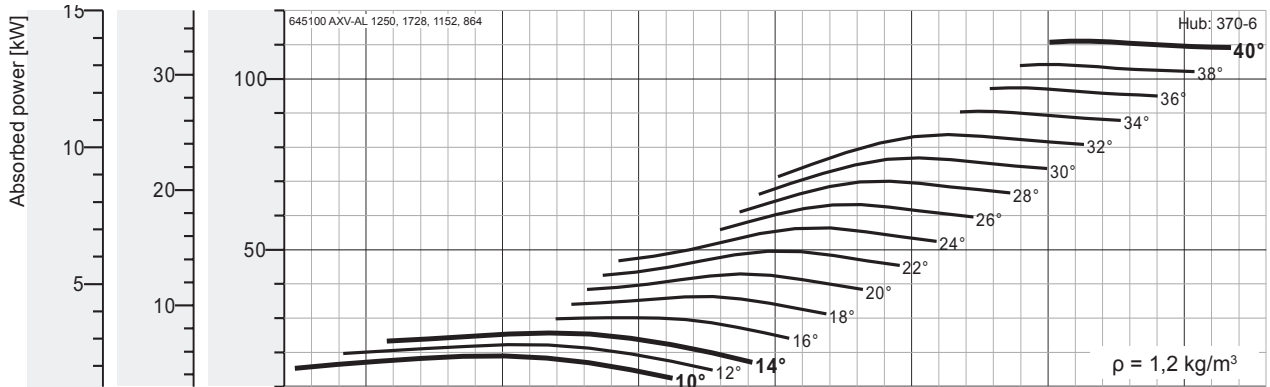

Speed [min⁻¹]

1728
4-pol

1152
6-pol

864
8-pol

Peak absorbed power [kW]

n [min ⁻¹]	Pitch angle [°]																
	8	10	12	14	16	18	20	22	24	26	28	30	32	34	36	38	40
864 motor	-	2,38	2,79	3,21	3,77	4,54	5,37	6,20	7,05	7,90	8,76	9,62	10,5	11,3	12,2	13,0	13,7
		3		4		5,5		7,5		11				15			
1152 motor	-	5,63	6,60	7,60	8,93	10,8	12,7	14,7	16,7	18,7	20,8	22,8	24,8	26,8	28,9	30,9	32,5
		7,5		11			15		18,5	22		30			37		
1728 motor	-	19,0	22,3	25,7	30,2	36,3	43,0	49,6	56,4	63,2	70,1	76,9	83,8	90,6	97,4	104,2	109,6
		22	30		37		45	55	75			90		110			

Fan test laboratory AMCA 210/99 Fig.12, Test Chamber. Performance certified is for installation type D - Ducted inlet, Ducted outlet. Performance ratings do not include the effects of appurtenances (accessories-belt cover, pulley & belt).

Sound power frequency spectrum L_{wref} Page 54-55

The A-weighted sound ratings shown have been calculated per AMCA International Standard 301. Values shown are for inlet LwiA sound power levels for installation Type D: ducted inlet, ducted outlet. Ratings include the effects of duct end correction.

Dimensions + Accessories Page 49-52

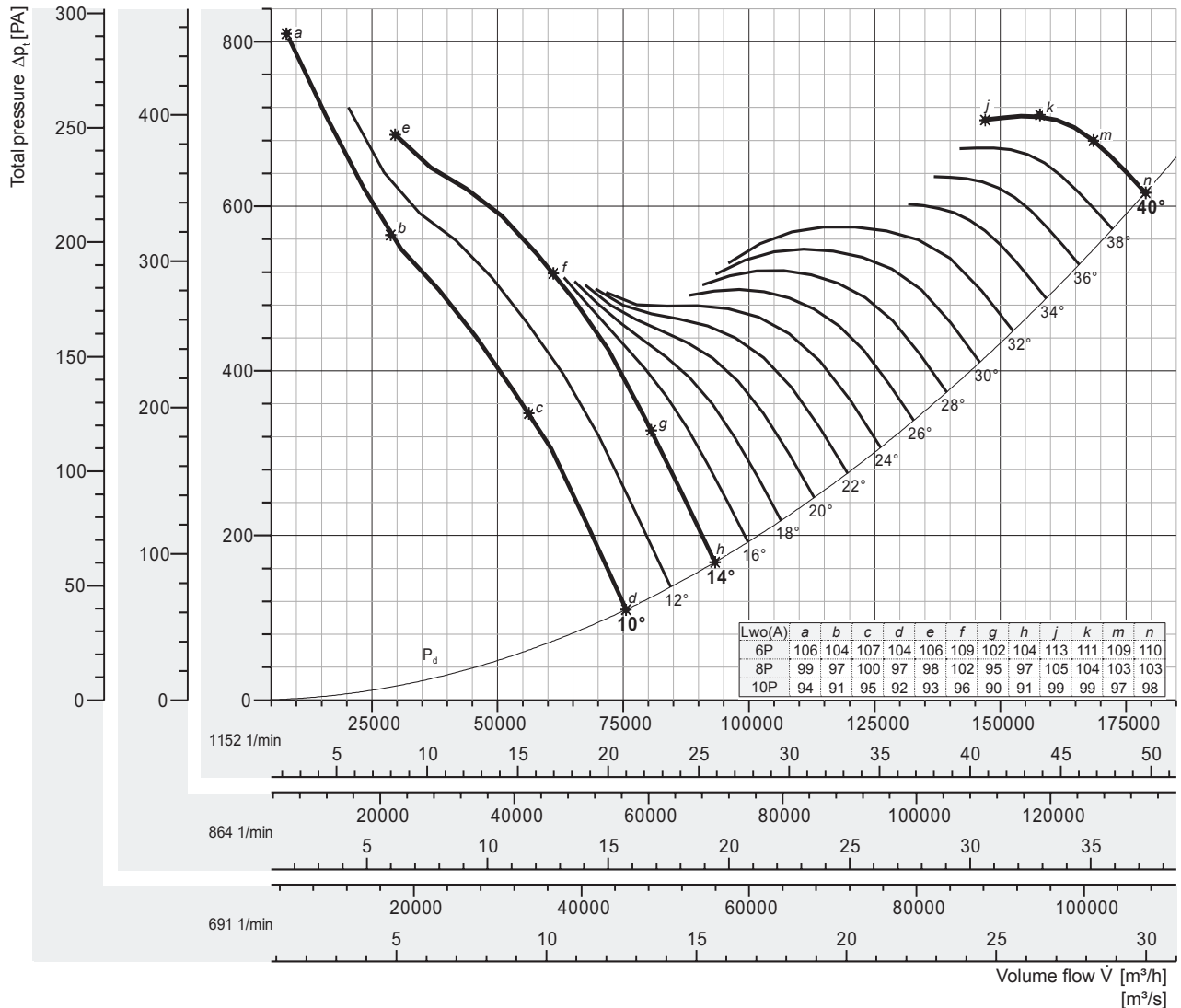

Peak absorbed power [kW]

n [min ⁻¹]	Pitch angle [°]																
	8	10	12	14	16	18	20	22	24	26	28	30	32	34	36	38	40
691 motor	-	1,86	2,29	2,73	3,13	3,81	4,52	5,25	5,98	6,70	7,42	8,15	8,86	9,60	10,3	11,0	11,8
		2,2	3		4		5,5		7,5			11					15
864 motor	-	3,63	4,47	5,33	6,13	7,45	8,84	10,3	11,7	13,1	14,5	15,9	17,3	18,8	20,2	21,6	23,0
		4	5,5		7,5		11		15			18,5		22			30
1152 motor	-	8,60	10,6	12,6	14,5	17,6	20,9	24,3	27,7	31,1	34,4	37,7	41,1	44,5	47,9	51,2	54,6
		11		15		18,5	22	30		37		45			55		

Fan test laboratory AMCA 210/99 Fig.15, Test Chamber. Performance certified for installation type A - Free inlet, Free outlet. Performance ratings do not include the effects of appurtenances (accessories-belt cover, pulley & belt).

Sound power frequency spectrum L_{wrel} Page 54-55

The A-weighted sound ratings shown have been calculated per AMCA International Standard 301. Values shown are for outlet LwoA sound power levels for installation Type A: free inlet, free outlet.

Dimensions + Accessories Page 49-52

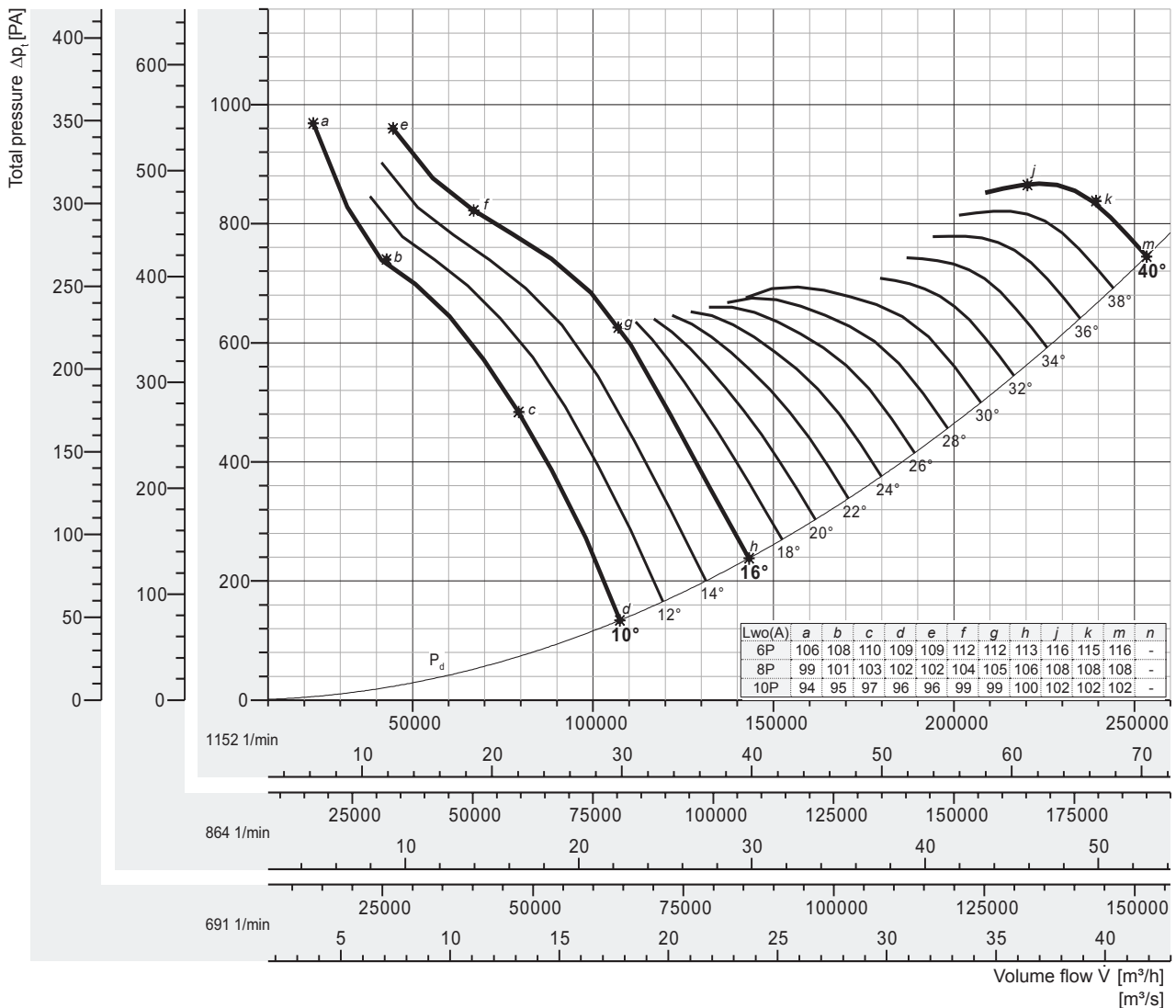
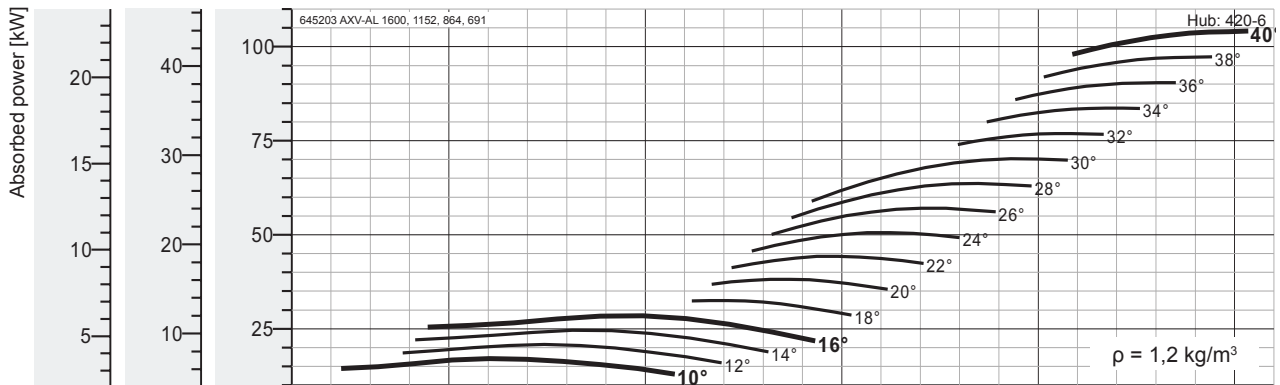

Speed [min⁻¹]

1152
6-pol

864
8-pol

691
10-pol

Peak absorbed power [kW]

n [min ⁻¹]	Pitch angle [°]																
	8	10	12	14	16	18	20	22	24	26	28	30	32	34	36	38	40
691 motor	-	3,68	4,49	5,31	6,13	7,02	8,24	9,55	10,9	12,3	13,7	15,2	16,6	18,1	19,5	21,0	22,5
		4	5,5		7,5		11			15		18,5			22		30
864 motor	-	7,19	8,77	10,4	12,0	13,7	16,1	18,5	21,3	24,1	26,8	29,6	32,4	35,3	38,1	41,0	43,9
		7,5	11		15		18,5		22	30		37		45			
1152 motor	-	17,0	20,8	24,6	28,4	32,5	38,2	44,3	50,6	57,0	63,6	70,2	76,9	83,6	90,4	97,3	104,1
		18,5	22	30		37	45		55	75			90		110		

Fan test laboratory AMCA 210/99 Fig.15, Test Chamber. Performance certified is for installation type A - Free inlet, Free outlet. Performance ratings do not include the effects of appurtenances (accessories-belt cover, pulley & belt).

Sound power frequency spectrum L_{wref} Page 54-55

The A-weighted sound ratings shown have been calculated per AMCA International Standard 301. Values shown are for outlet LwoA sound power levels for installation Type A: free inlet, free outlet.

Dimensions + Accessories Page 49-52

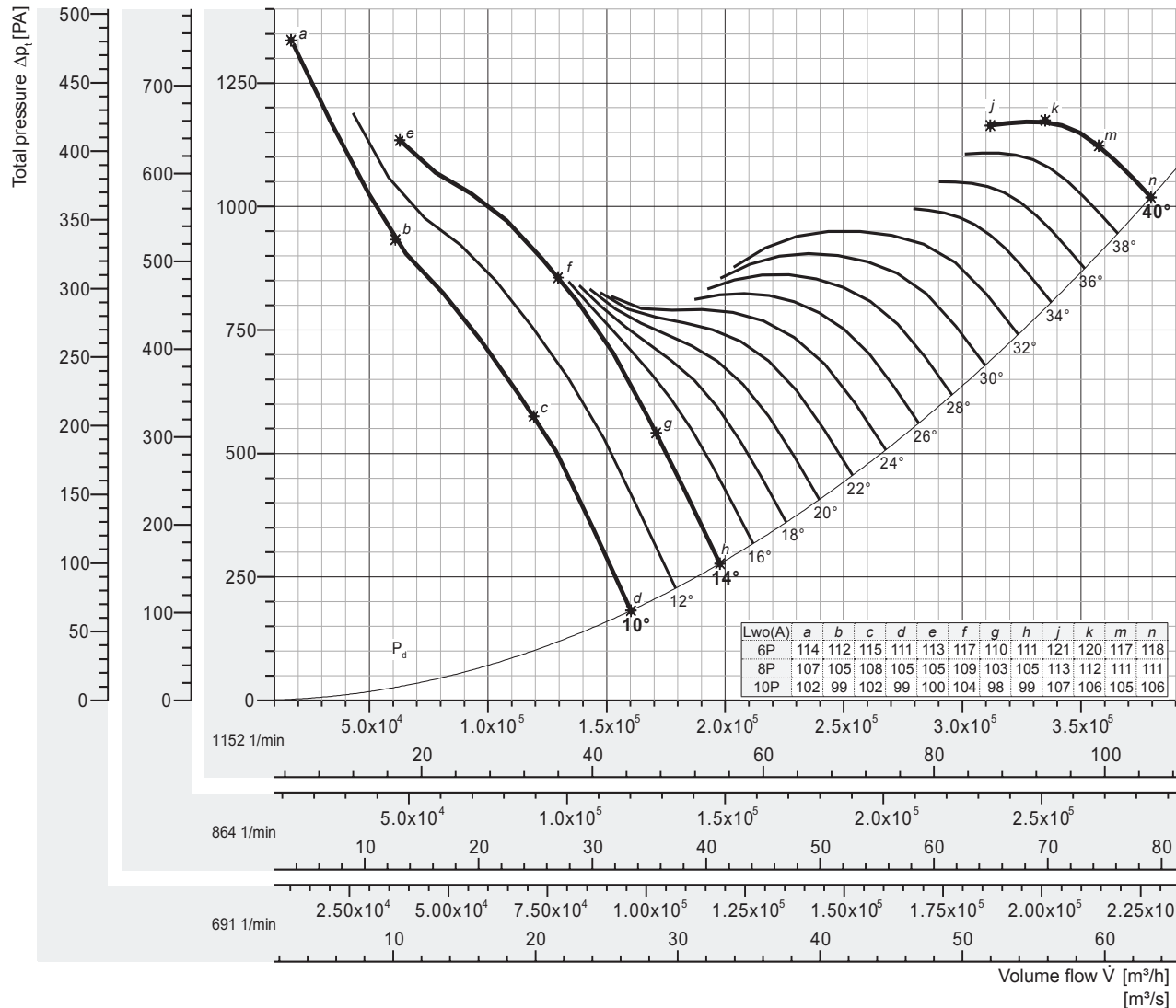
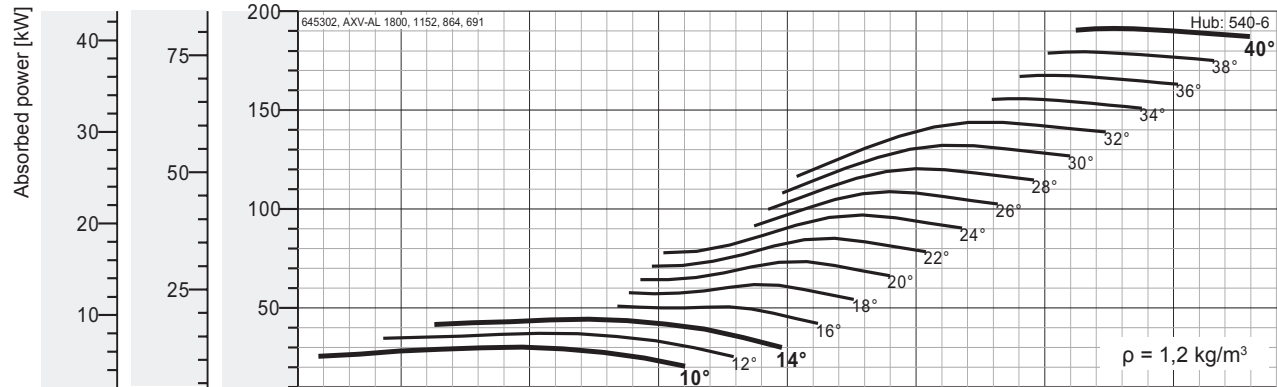

Peak absorbed power [kW]

n [min ⁻¹]	Pitch angle [°]																
	8	10	12	14	16	18	20	22	24	26	28	30	32	34	36	38	40
691 motor	-	6,50	8,01	9,56	11,0	13,3	15,8	18,4	20,9	23,5	26,0	28,5	31,0	33,6	36,2	38,7	41,3
864 motor	-	12,7	15,7	18,7	21,4	26,1	30,9	35,9	40,9	45,9	50,8	55,8	60,7	65,7	70,7	75,7	80,7
1152 motor	-	30,0	37,0	44,3	50,8	61,8	73,3	85,2	97,0	108,7	120,5	132,2	143,8	155,8	167,6	179,5	191,3

Fan test laboratory AMCA 210/99 Fig. 15, Test Chamber. Performance certified is for installation type A - Free inlet, Free outlet. Performance ratings do not include the effects of appurtenances (accessories-belt cover, pulley & belt).

The A-weighted sound ratings shown have been calculated per AMCA International Standard 301. Values shown are for outlet LwoA sound power levels for installation Type A: free inlet, free outlet.

Sound power frequency spectrum L_{wrel} Page 54-55

Dimensions + Accessories Page 49-52

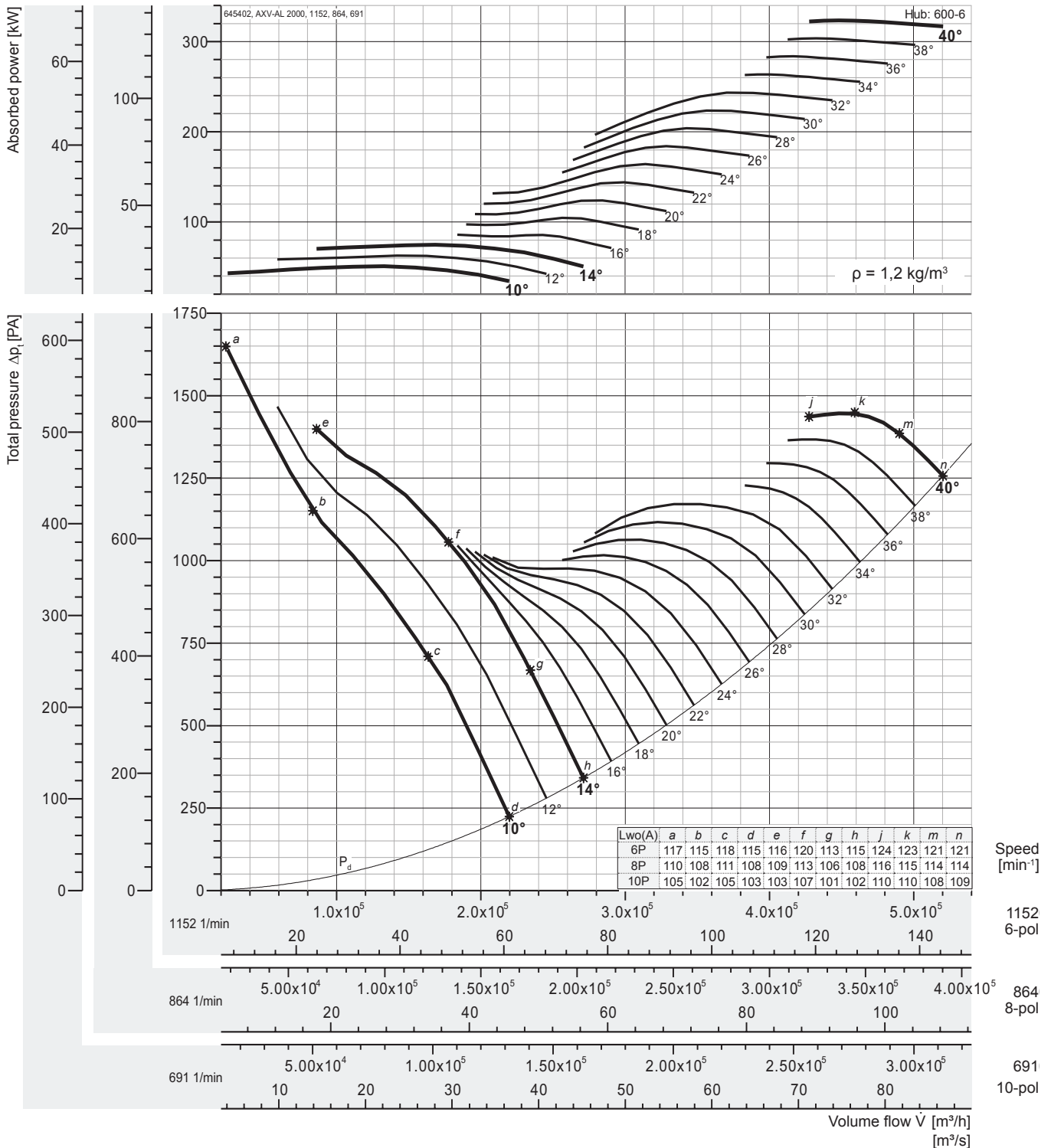

Peak absorbed power [kW]

n [min ⁻¹]	Pitch angle [°]																
	8	10	12	14	16	18	20	22	24	26	28	30	32	34	36	38	40
691 motor	-	11,0	13,6	16,2	18,5	22,6	26,8	31,1	35,4	39,7	44,0	48,3	52,5	56,9	61,2	65,5	69,8
864 motor	-	21,5	26,5	31,6	36,3	44,1	52,3	60,8	69,2	77,6	86,0	94,3	102,6	111,2	119,6	128,1	136,5
1152 motor	-	50,9	62,8	74,9	86,0	104,5	124,1	144,1	164,0	183,9	203,8	223,6	243,3	263,6	283,6	303,6	323,6

Fan test laboratory AMCA 210/99 Fig.15, Test Chamber. Performance certified is for installation type A - Free inlet, Free outlet. Performance ratings do not include the effects of appurtenances (accessories-belt cover, pulley & belt).

Sound power frequency spectrum L_{wref} Page 54-55

The A-weighted sound ratings shown have been calculated per AMCA International Standard 301. Values shown are for outlet LwoA sound power levels for installation Type A: free inlet, free outlet.

Dimensions + Accessories Page 49-52

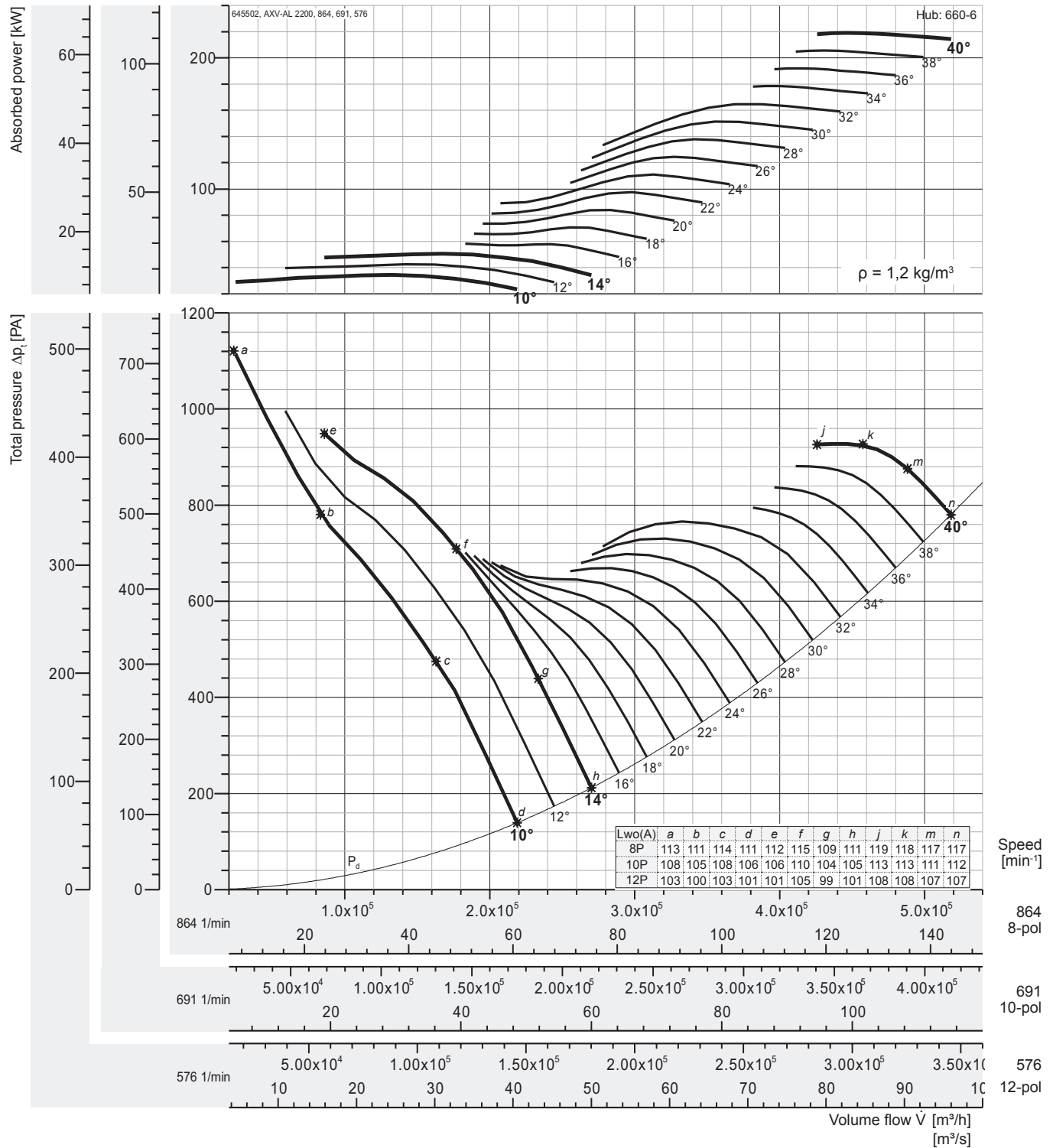

Peak absorbed power [kW]

n [min ⁻¹]	Pitch angle [°]																
	8	10	12	14	16	18	20	22	24	26	28	30	32	34	36	38	40
576 motor	-	10,2	12,6	15,0	17,3	21,0	24,9	28,9	32,9	36,9	40,9	44,9	48,8	52,9	56,9	60,9	64,9
691 motor	-	17,6	21,7	25,9	29,8	36,2	43,0	49,9	56,8	63,7	70,6	77,5	84,3	91,3	98,2	105,2	112,1
864 motor	-	34,5	42,5	50,7	58,3	70,8	84,0	97,6	111,1	124,6	138,0	151,4	164,8	178,5	192,1	205,6	219,2

Fan test laboratory AMCA 210/99 Fig. 15, Test Chamber. Performance certified is for installation type A - Free inlet, Free outlet. Performance ratings do not include the effects of appurtenances (accessories-belt cover, pulley & belt).

Sound power frequency spectrum L_{wrel} Page 54-55

The A-weighted sound ratings shown have been calculated per AMCA International Standard 301. Values shown are for outlet LwoA sound power levels for installation Type A: free inlet, free outlet.

Dimensions + Accessories Page 49-52

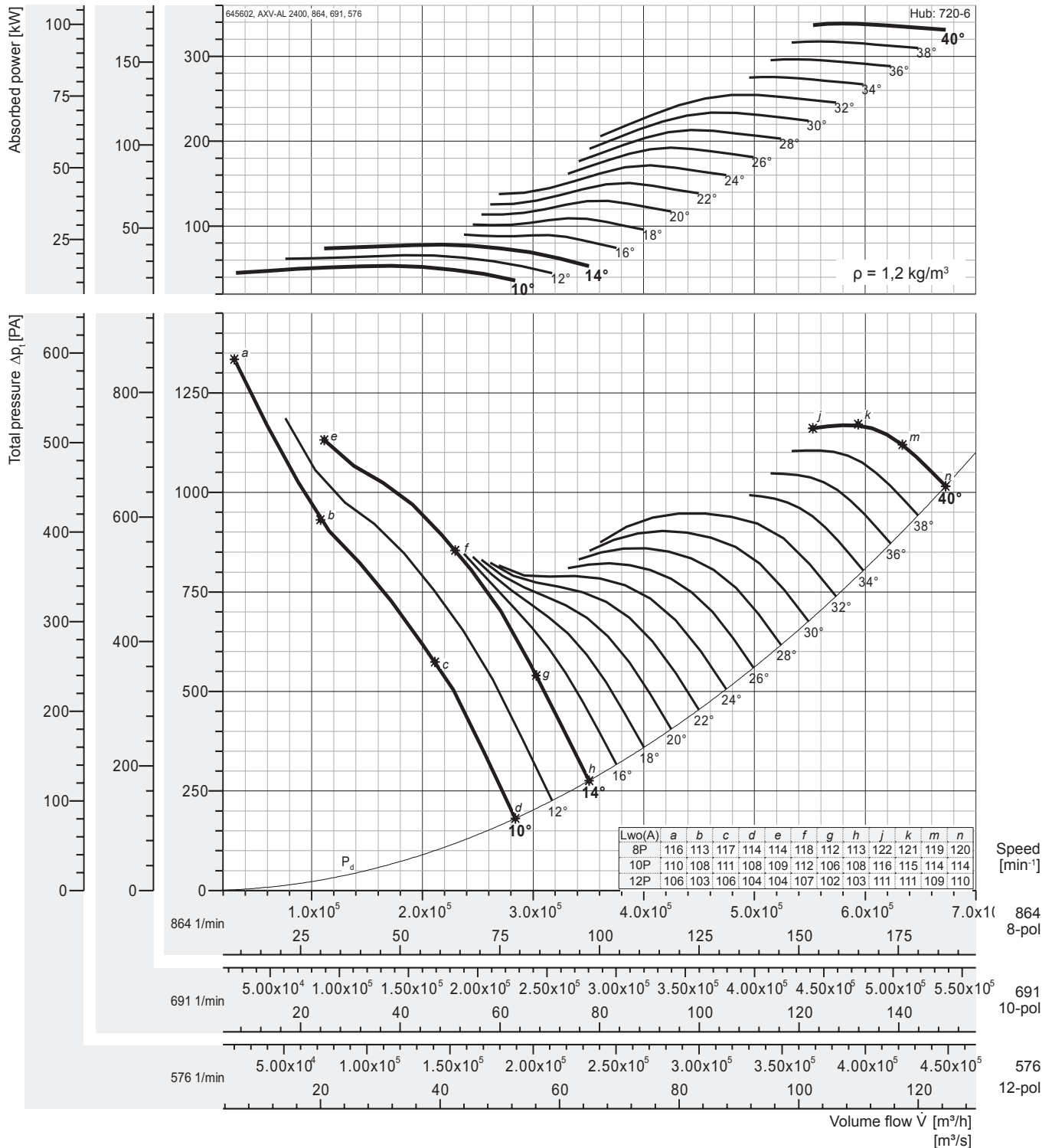

Peak absorbed power [kW]

n [min ⁻¹]	Pitch angle [°]																
	8	10	12	14	16	18	20	22	24	26	28	30	32	34	36	38	40
576 motor	-	15,8	19,5	23,2	26,7	32,4	38,4	44,6	50,8	57,0	63,2	69,3	75,4	81,7	87,9	94,1	100,3
691 motor	-	27,3	33,6	40,1	46,0	55,9	66,4	77,1	87,8	98,4	109,0	119,6	130,2	141,0	151,7	162,4	173,1
864 motor	-	53,3	65,7	78,3	89,9	109,3	129,7	150,7	171,5	192,4	213,1	233,8	254,5	275,7	296,6	317,5	338,4

Fan test laboratory AMCA 210/99 Fig.15, Test Chamber. Performance certified is for installation type A - Free inlet, Free outlet. Performance ratings do not include the effects of appurtenances (accessories-belt cover, pulley & belt).

Sound power frequency spectrum L_{wref} Page 54-55

The A-weighted sound ratings shown have been calculated per AMCA International Standard 301. Values shown are for outlet LwoA sound power levels for installation Type A: free inlet, free outlet.

Dimensions + Accessories Page 49-52



Performance Curve

AXV 2500, 60 Hz

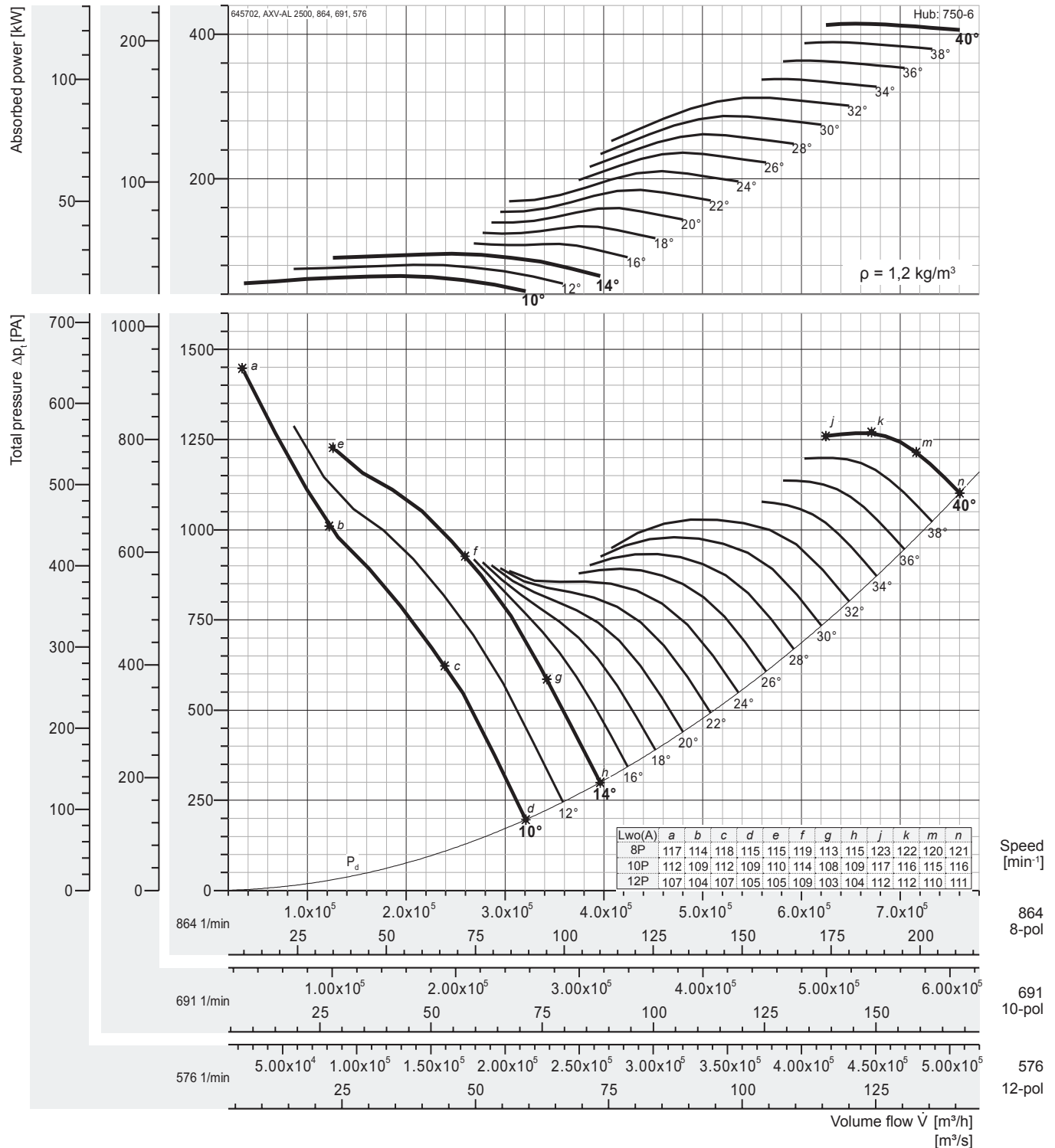

Peak absorbed power [kW]

n [min ⁻¹]	Pitch angle [°]																
	8	10	12	14	16	18	20	22	24	26	28	30	32	34	36	38	40
576 motor	-	19,4	23,9	28,4	32,7	39,7	47,1	54,7	62,3	69,9	77,4	84,9	92,4	100,1	107,7	115,3	122,9
691 motor	-	33,4	41,2	49,1	56,4	68,6	81,4	94,5	107,6	120,7	133,7	146,7	159,6	172,9	186,0	199,1	212,3
864 motor	-	65,3	80,5	96,0	110,3	134,1	159,1	184,7	210,3	235,9	261,3	286,7	312,0	338,0	363,6	389,3	414,9

Fan test laboratory AMCA 210/99 Fig. 15, Test Chamber. Performance certified is for installation type A - Free inlet, Free outlet. Performance ratings do not include the effects of appurtenances (accessories-belt cover, pulley & belt).

Sound power frequency spectrum L_{wrel} Page 54-55

The A-weighted sound ratings shown have been calculated per AMCA International Standard 301. Values shown are for outlet LwoA sound power levels for installation Type A: free inlet, free outlet.

Dimensions + Accessories Page 49-52

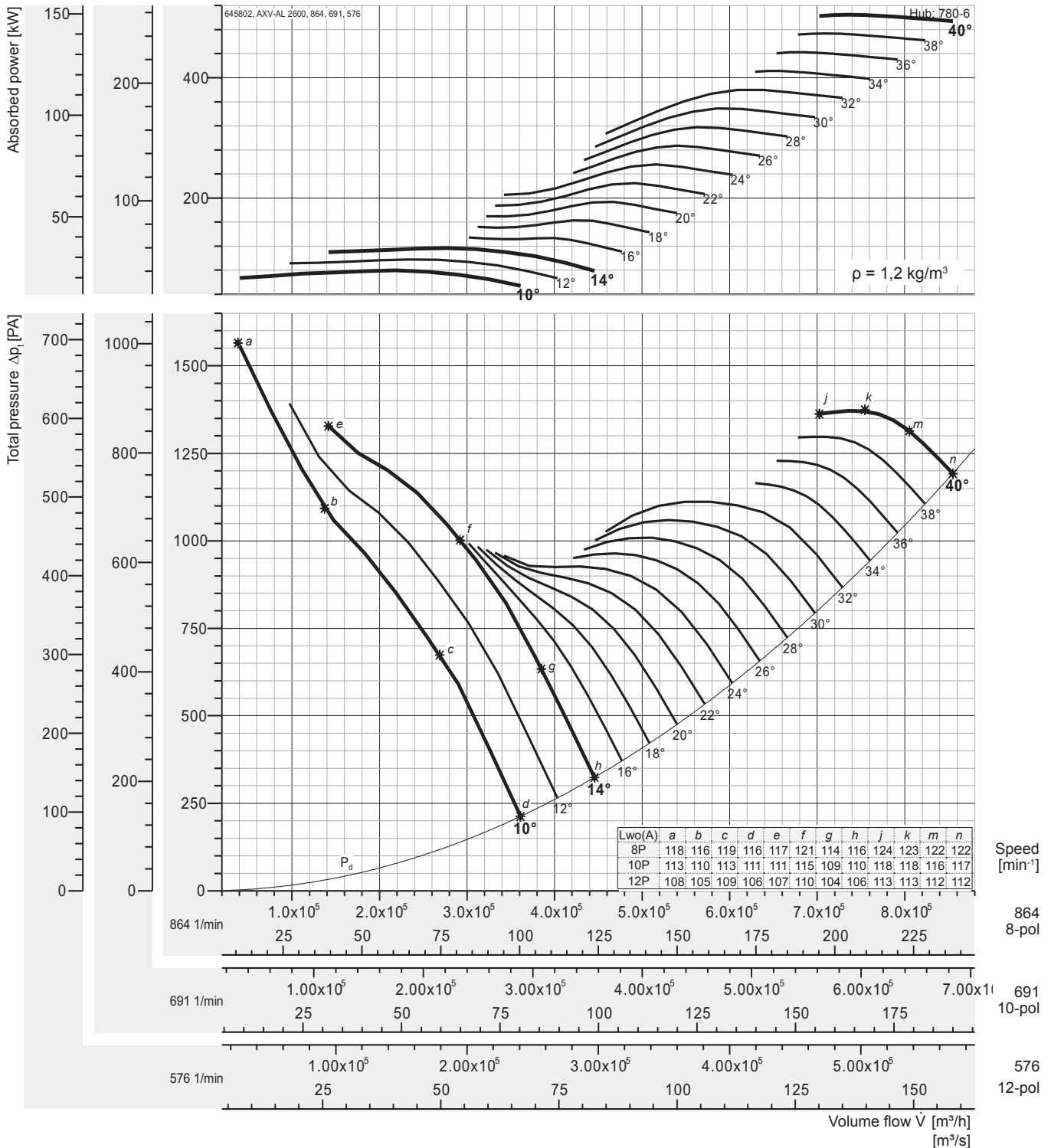

Peak absorbed power [kW]

n [min ⁻¹]	Pitch angle [°]																
	8	10	12	14	16	18	20	22	24	26	28	30	32	34	36	38	40
576 motor	-	23,5	29,0	34,6	39,8	48,3	57,3	66,6	75,8	85,0	94,2	103,3	112,4	121,8	131,0	140,3	149,5
		30		37	45	55	75		90		110		132		160		
691 motor	-	40,6	50,1	59,8	68,6	83,4	99,0	115,0	130,9	146,8	162,6	178,4	194,1	210,3	226,3	242,2	258,2
		45	55	75		90	110	132		160	200		250				315
864 motor	-	79,4	98,0	116,8	134,2	163,1	193,5	224,7	255,9	286,9	317,9	348,7	379,5	411,1	442,3	473,5	504,7
		90	110	160		200		250	315		355	450				500	560

Fan test laboratory AMCA 210/99 Fig.15, Test Chamber. Performance certified is for installation type A - Free inlet, Free outlet. Performance ratings do not include the effects of appurtenances (accessories-belt cover, pulley & belt).

Sound power frequency spectrum L_{wref} Page 54-55

The A-weighted sound ratings shown have been calculated per AMCA International Standard 301. Values shown are for outlet LwoA sound power levels for installation Type A: free inlet, free outlet.

Dimensions + Accessories Page 49-52

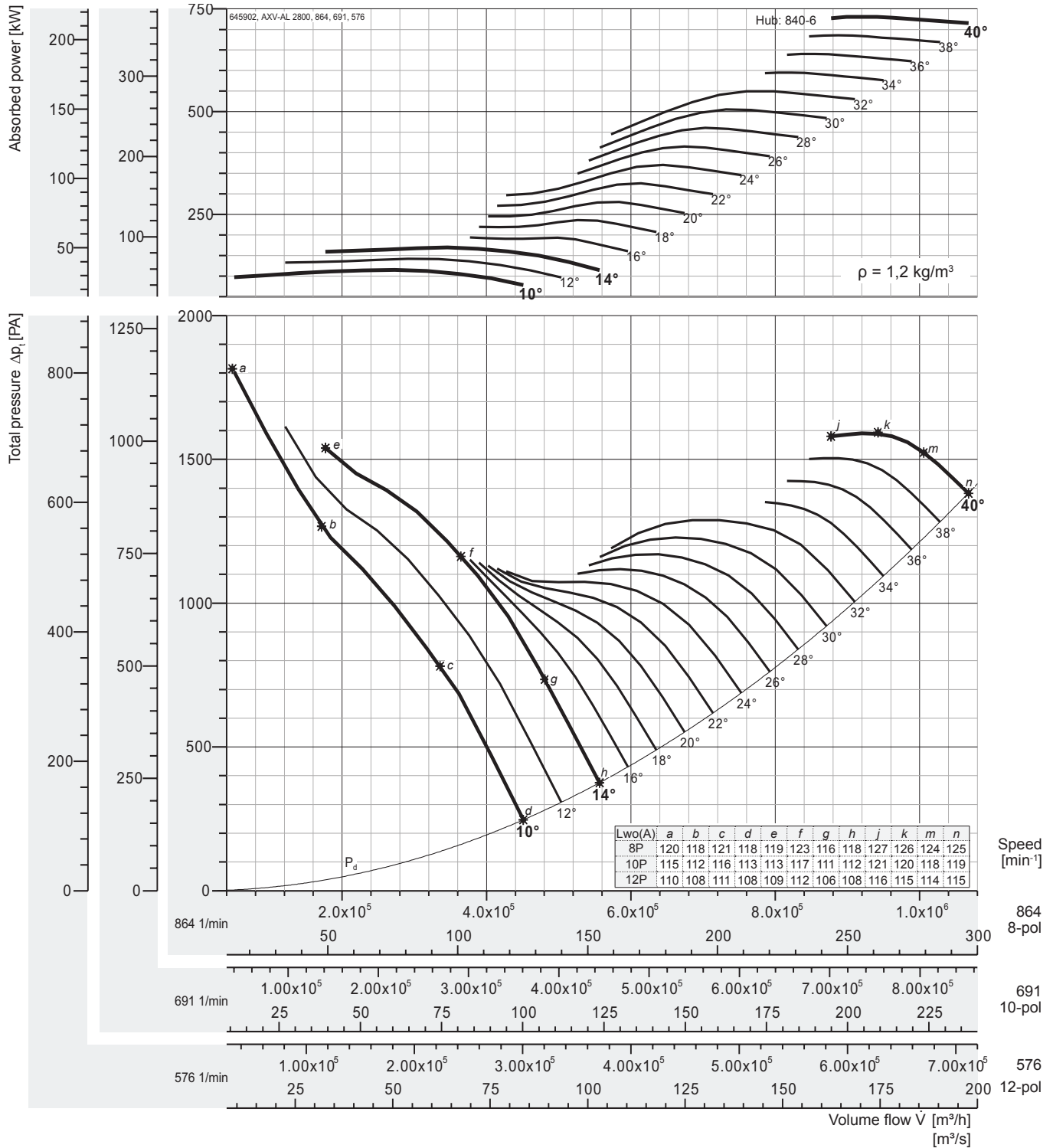

Peak absorbed power [kW]

n [min ⁻¹]	Pitch angle [°]																
	8	10	12	14	16	18	20	22	24	26	28	30	32	34	36	38	40
576 motor	-	34,1	42,0	50,1	57,6	70,0	83,0	96,4	109,8	123,1	136,4	149,6	162,8	176,4	189,7	203,1	216,5
		37	45	55	75		90	110		132	160		200			250	
691 motor	-	58,8	72,6	86,5	99,4	120,8	143,3	166,4	189,5	212,5	235,4	258,3	281,1	304,5	327,6	350,7	373,8
		75	90	110	132	160	200		250		315			355		450	
864 motor	-	115,0	141,9	169,2	194,3	236,1	280,2	325,4	370,5	415,4	460,3	504,9	549,5	595,3	640,4	685,6	730,8
		132	160	200		250	315	355	450		500	560		630	710		-

Fan test laboratory AMCA 210/99 Fig. 15, Test Chamber. Performance certified is for installation type A - Free inlet, Free outlet. Performance ratings do not include the effects of appurtenances (accessories-belt cover, pulley & belt).

Sound power frequency spectrum L_{wrel} Page 54-55

The A-weighted sound ratings shown have been calculated per AMCA International Standard 301. Values shown are for outlet LwoA sound power levels for installation Type A: free inlet, free outlet.

Dimensions + Accessories Page 49-52

Direct Driven

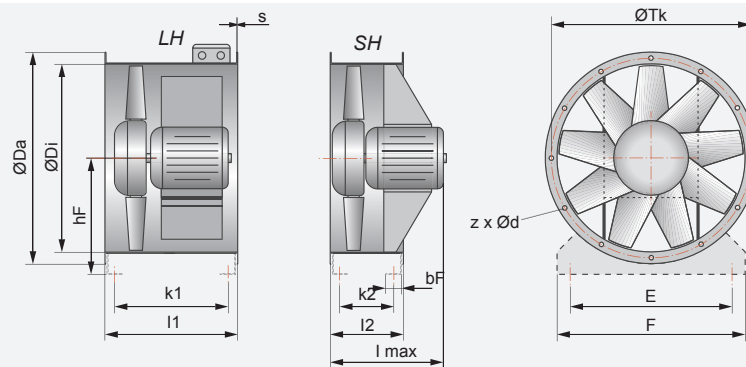

Belt Driven

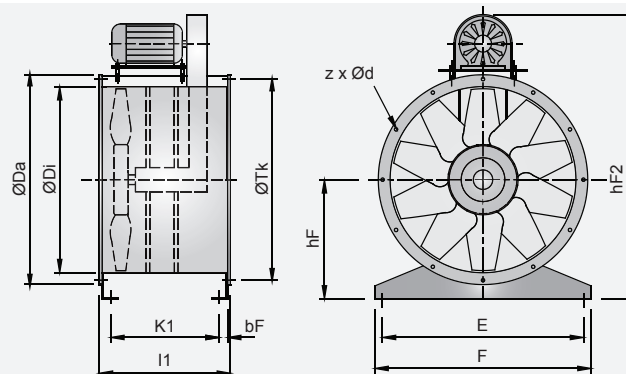

Model size	Da [mm]	Di [mm]	hF [mm]	hF2 [mm]	z x d [mm]	Tk [mm]	E [mm]	F [mm]	bF [mm]
355	438	359	225	750	8 x 12	405	305	355	60
400	484	401	250	810	12 x 12	448	350	400	60
450	534	450	280	860	12 x 12	497	400	450	60
500	584	504	315	1041	12 x 12	551	440	500	70
560	664	565	345	1094	16 x 14	629	500	560	70
630	734	634	400	1246	16 x 14	698	570	630	70
710	814	711	450	1454	16 x 14	775	650	710	70
800	904	797	500	1544	12* x 14	861	730	800	80
900	1004	894	580	1746	12* x 14	958	830	900	80
1000	1105	1003	630	1821	12* x 14	1067	930	990	80
1120	1245	1125	690	1990	16* x 18	1200	1050	1110	100
1250	1370	1250	750	2175	16* x 18	1337	1180	1240	100
1400	1525	1405	830	2362	16* x 18	1475	1330	1390	100
1600	1725	1605	930	2550	20* x 18	1675	1530	1590	100

Model size	LH/1				LH/2				SH			
	s [mm]	k1 [mm]	l1 [mm]	motor max.	s [mm]	k1 [mm]	l1 [mm]	motor max.	s [mm]	k2 [mm]	l2 [mm]	lmax [mm]
355	2	356	420	80					2	161	225	350
400	2	371	435	90					2	161	225	400
450	2	371	435	112					2	161	225	500
500	2	396	470	112					2	151	225	600
560	2	396	470	112	3	624	700	160	3	224	300	750
630	2	396	470	112	3	624	700	160	3	224	300	750
710	2,5	395	470	112	2,5	490	565	132	2,5	225	300	600
800	2,5	385	470	112	3	614	700	160	3	214	300	750
900	3	479	565	132	4	612	700	160	4	212	300	750
1000	3	479	565	132	4	692	780	180	4	262	350	800
1120	4	592	700	160	4	892	1000	200	4	242	350	800
1250	4	592	700	160	4	892	1000	225	4	242	350	800
1400					4	892	1000	225	4	242	350	800
1600					4	892	1000	280	4	242	350	800



SH

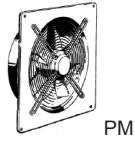

PM

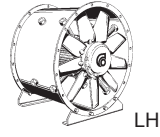

LH

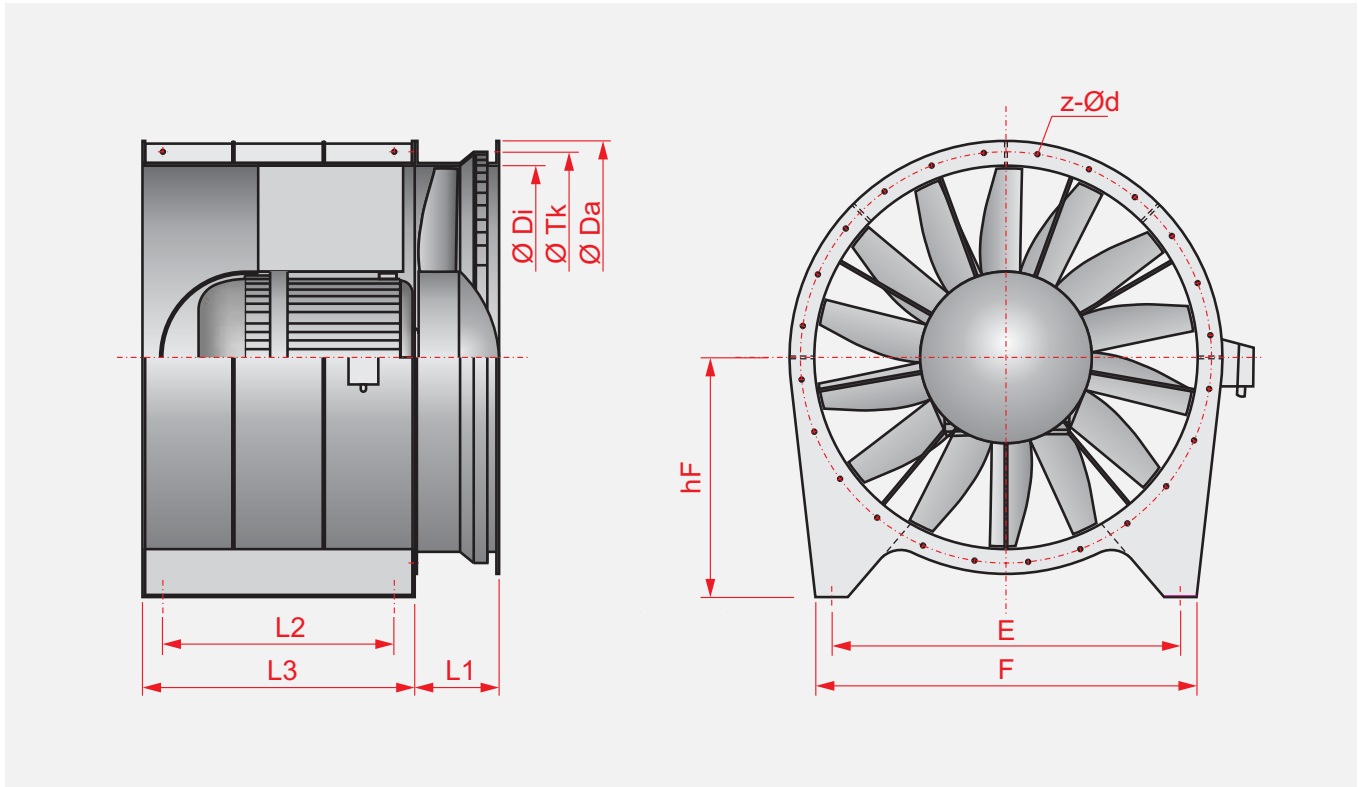

Baugröße size	Da [mm]	Di [mm]	hF [mm]	z x d [mm]	Tk [mm]	E [mm]	F [mm]	L1 [mm]	L2 [mm]	L3 [mm]
1800	2010	1805	1120	24x18	1920	1660	1800	400	1200	1400
2000	2210	2005	1165	32x18	2120	1820	2000	445	1300	1500
2200	2440	2205	1265	32x18	2340	2020	2200	490	1400	1650
2400	2630	2405	1370	32x18	2530	2220	2400	550	1500	1800
2500	2740	2505	1420	36x24	2640	2320	2500	555	1530	1820
2600	2840	2605	1470	36x24	2740	2380	2600	590	1580	1850
2800	3150	2805	1570	36x24	3000	2500	2800	1300	1680	1900

Axial Flow Fans

Dimensions



Square Wall Plate

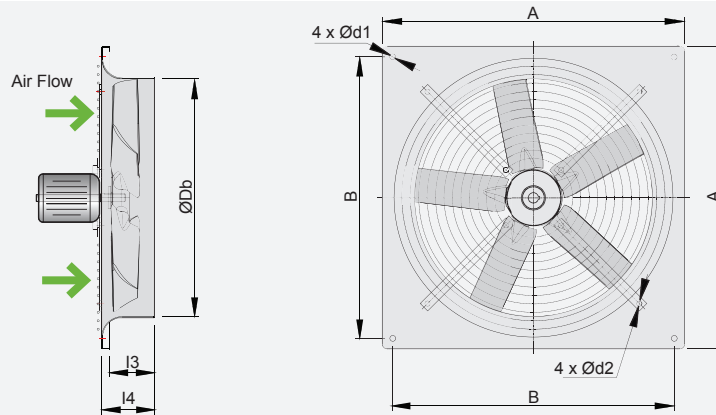

Baugröße size	A [mm]	B [mm]	Db [mm]	d1 [mm]	d2 [mm]	l3 [mm]	l4 [mm]
355	485	435	360	9	8,5	75	85
400	540	490	410	9	8,5	88	100
450	575	535	460	11	8,5	88	100
500	655	615	510	11	8,5	106	120
560	725	675	560	11	8,5	121	135
630	805	750	634	11	8,5	135	150
710	850	810	710	14,5	10,5	150	170
800	970	910	795	14,5	10,5	194	210
900	1070	1010	899	14,5	10,5	200	220
1000	1170	1110	999	14,5	10,5	200	220

Bifurcated Axial Fan

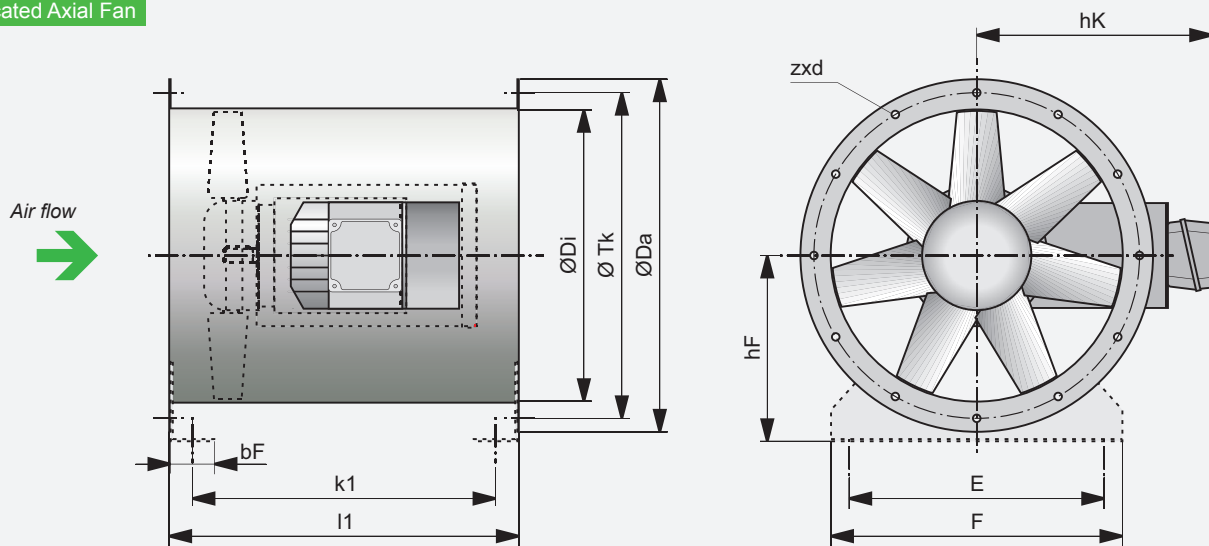

Größe	ØDa [mm]	ØDi [mm]	ØTk [mm]	E [mm]	F [mm]	zxd	hF [mm]	bF [mm]	k1 [mm]	l1 [mm]	hK [mm]	Motor max.	Art.Nr.:
AXV-BIF 400S	484	400	448	350	400	12x12	250	60	415	480	324	90(2.2 kW)	303719
AXV-BIF 450	534	450	497	400	450	12x12	280	60	415	480	331	90(2.2 kW)	303720
AXV-BIF 560	664	560	629	500	560	16x14	345	70	624	700	410	132(7.5 kW)	303721
AXV-BIF 630	734	630	698	570	630	16x14	400	70	624	700	435	100(2.2 kW)	303722
AXV-BIF 710	814	711	775	650	710	16x14	450	70	624	700	476		303723
AXV-BIF 800	904	800	861	730	800	12*x14	500	80	614	700	504	112(4.0 kW)	303716
AXV-BIF 900	1004	894	958	830	900	12*x14	580	80	612	700	572	132(7.5 kW)	303717
AXV-BIF1000	1105	1000	1067	930	990	12*x14	630	80	692	780		160(15.0kW)	303724

• We reserve the right to alter measurements without notice in case of technical improvements.
 • The square wall plate and Bifurcated Axial Fan are not licensed by AMCA International.

ED

Bellmouth inlet

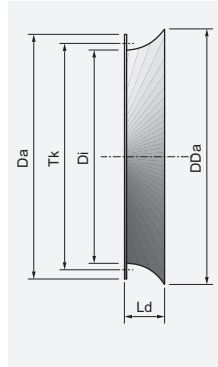

LRK

Air-operated damper

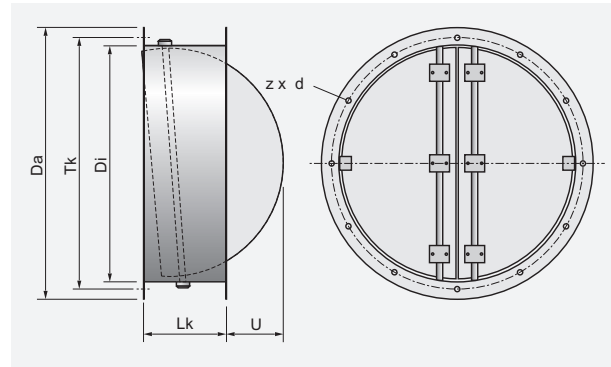

GL-AXV

Matching flange

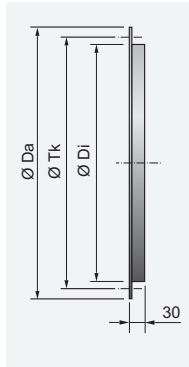

EV-AXV

Flexible connector compl.

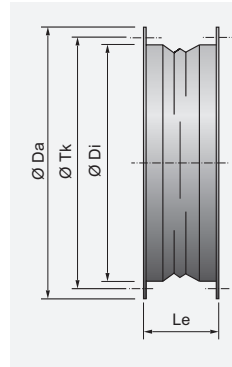

GV-AXV

Up-stream guide vane

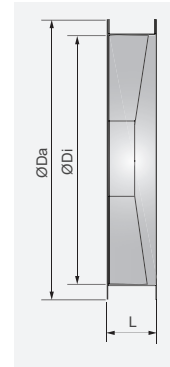

Model size	D_a [mm]	D_i [mm]	T_k [mm]	$z \times d$ [mm]	DD_a [mm]	L [mm]	L_d [mm]	L_k [mm]	L_e [mm]	U [mm]
355	438	359	405	8 x 12	435	152	165	250	130	-
400	484	401	448	12 x 12	507	152	165	250	130	-
450	534	450	497	12 x 12	555	152	165	250	130	15
500	584	504	551	12 x 12	617	152	165	250	130	45
560	664	565	629	16 x 14	667	152	165	250	130	80
630	734	634	698	16 x 14	757	152	165	250	130	120
710	814	711	775	16 x 14	816	190	170	350	130	60
800	904	797	861	12* x 14	915	190	250	350	130	110
900	1004	894	958	12* x 14	1015	200	250	350	130	170
1000	1105	1003	1067	12* x 14	1115	200	250	350	130	225
1120	1245	1125	1200	16* x 18	1243	240	250	350	130	255
1250	1370	1250	1337	16* x 18	1364	240	250	400	170	375
1400	1525	1405	1475	16* x 18	1523	260	250	400	170	450
1600	1725	1605	1675	20* x 18	1723	260	250	400	170	550

Sound power levels

This term refers to the power which a source radiates as sound. Sound power levels are expressed in decibels with a reference level of 1 picoWatt. The sound power level of a source remains the same regardless of its environment and the distance to the listener.

If the sound power frequency spectrum is needed, for as follows: example, the design of sound attenuators, the A- rated sound power levels at particular octave band frequency L_{WA} can be calculated by subtracting the relative sound L_{wrel} .

$$L_{WA} = L_{wi} + L_{wrel}$$

Sound pressure level

These are pressure fluctuations generated by a source expressed in decibels with a reference level of 20 μ Pa. The sound pressure level varies with the distance of a sound source to the listener and its environment.

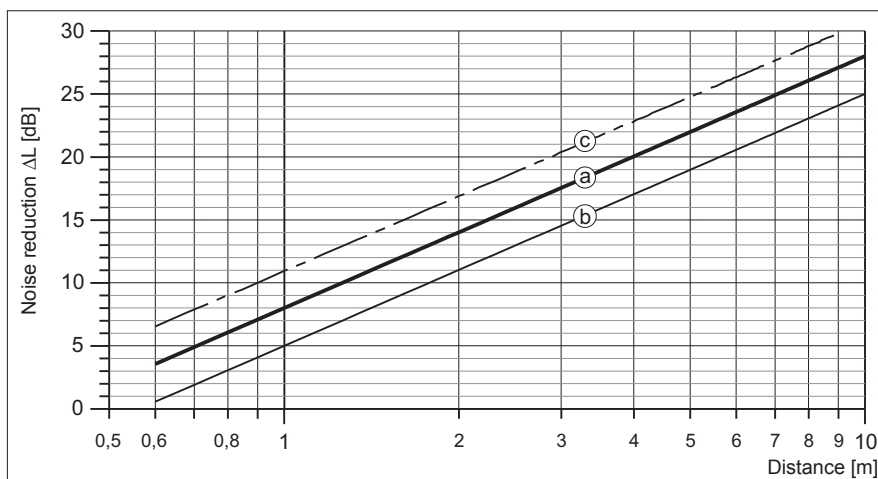

Sound level reduction half sphere

- a: without reflexion
- b: with reflexion
- c: full sphere without reflexion

Frequencies

Sound is split into different frequencies. Frequencies of human hearing range from about 20 cycles per second (Hz) to 20.000 cycles per second (Hz). For practical purposes, WOLTER publishes noise data in eight octave bands with the centre frequencies of (63,) 125, 250, 500, 1000, 2000, 4000 and 8000 Hz. Each fan has its own specific correction factor which is to be deducted from sound power according to the octave band and is shown on the bottom line of each performance curve.

A-weighted sound pressure level in dB (A)

The human ear is more sensitive to sound in some frequencies than in others. The A-weighting is an attempt to reflect this natural perception of sound. The A-weighting is a set of figures which are applied to the sound pressure levels. The levels in each of the octave bands are added logarithmically to give a single figure. The A-weighting over the octave band is as follows:

Table 1)

Frequency [Hz]	63	125	250	500	1000	2000	4000	8000
A-weighting [dB]	-26,2	-16,1	-8,6	-3,2	0	+1,2	+1,0	-1,1

Table 2)
Addition of sound levels

Difference between two sound levels [dB]	Add to the higher level [dB]
0 - 1	3
2 - 3	2
4 - 9	1
≥ 10	0

$$L_{\Sigma} = 10 \cdot \lg(10^{0,1 \cdot L_1} + 10^{0,1 \cdot L_2} + \dots + 10^{0,1 \cdot L_n})$$

where:

L_1 = sound level of a source 1

L_{Σ} = resulting summation sound level

Summation of several congeneric sound levels

$$L_{\Sigma} = L_1 + 10 \cdot \lg(z)$$

where:

z = number of sources

L_1 = sound level of a single source

L_{Σ} = resulting summation sound level

Axial Flow Fans

Sound Information

Relative Sound Power Frequency Spectrum (L_{wrel}) [dB]

Fan Model	Poles	63	125	250	500	1000	2000	4000	8000
Size	[-]	[Hz]	[Hz]	[Hz]	[Hz]	[Hz]	[Hz]	[Hz]	[Hz]
355	2	-14	-10	-2	-10	-19	-26	-28	-33
	4	-10	-1	-10	-18	-26	-28	-33	-37
	6	-2	-5	-14	-22	-26	-30	-35	-39
400	2	-11	-8	-2	-12	-15	-17	-21	-26
	4	-8	-2	-12	-14	-17	-21	-25	-34
	6	-2	-7	-13	-15	-19	-23	-30	-39
450	2	-8	-5	-5	-13	-18	-22	-24	-26
	4	-4	-4	-12	-17	-21	-24	-26	-27
	6	-2	-7	-14	-18	-22	-23	-25	-27
500	2	-8	-5	-6	-10	-15	-18	-21	-26
	4	-4	-5	-9	-14	-17	-21	-25	-26
	6	-3	-6	-11	-14	-18	-22	-25	-24
560	2	-11	-8	-4	-7	-15	-18	-22	-26
	4	-7	-4	-6	-14	-18	-21	-26	-31
	6	-4	-4	-11	-16	-19	-23	-28	-33
630	2	-9	-6	-8	-5	-13	-15	-19	-22
	4	-6	-8	-4	-12	-15	-18	-22	-27
	6	-7	-4	-7	-13	-15	-19	-23	-29
710	4	-7	-4	-8	-12	-14	-18	-22	-28
	6	-4	-5	-11	-12	-16	-20	-25	-31
	8	-3	-7	-11	-13	-17	-21	-27	-33
800	4	-6	-6	-6	-11	-13	-17	-20	-26
	6	-5	-5	-9	-11	-15	-18	-23	-30
	8	-4	-5	-10	-12	-16	-19	-25	-32
900	4	-7	-7	-6	-10	-11	-14	-18	-25
	6	-7	-5	-8	-10	-12	-16	-21	-29
	8	-6	-5	-9	-10	-13	-17	-24	-32
1000	4	-7	-5	-7	-12	-12	-13	-17	-22
	6	-5	-5	-10	-11	-12	-15	-19	-26
	8	-4	-6	-11	-10	-12	-16	-21	-30
1120	4	-7	-6	-9	-9	-12	-15	-19	-24
	6	-4	-7	-8	-10	-14	-17	-21	-28
	8	-4	-7	-8	-11	-14	-17	-22	-31
1250	4	-7	-5	-9	-11	-12	-14	-18	-23
	6	-5	-6	-10	-10	-12	-16	-19	-27
	8	-4	-8	-10	-10	-13	-17	-22	-31
1400	6	-9	-8	-10	-9	-10	-12	-15	-20
	8	-7	-9	-9	-9	-10	-13	-16	-23
	10	-7	-9	-9	-9	-10	-13	-18	-25
1600	6	-9	-7	-8	-9	-11	-15	-19	-24
	8	-7	-7	-8	-9	-12	-17	-21	-25
	10	-7	-7	-8	-9	-13	-18	-22	-26

* Sound power frequency spectrum calculated with this L_{wrel} are not licensed by AMCA.

Relative Sound Power Frequency Spectrum (L_{wrel}) [dB]

Fan Model	Poles	63	125	250	500	1000	2000	4000	8000
Size	[-]	[Hz]	[Hz]	[Hz]	[Hz]	[Hz]	[Hz]	[Hz]	[Hz]
1800	6	-9	-7	-10	-10	-10	-12	-16	-21
	8	-7	-8	-9	-9	-10	-13	-17	-23
	10	-7	-9	-9	-9	-10	-13	-18	-25
2000	6	-8	-7	-10	-10	-11	-13	-16	-21
	8	-6	-8	-10	-9	-10	-13	-17	-24
	10	-7	-9	-9	-9	-10	-14	-18	-25
2200	8	-6	-8	-10	-10	-10	-13	-17	-24
	10	-6	-9	-9	-9	-11	-14	-18	-26
	12	-7	-9	-9	-9	-11	-15	-20	-27
2400	8	-6	-8	-10	-10	-11	-13	-17	-24
	10	-6	-9	-9	-9	-11	-14	-19	-26
	12	-7	-9	-9	-9	-11	-15	-20	-27
2500	8	-6	-8	-10	-10	-11	-14	-17	-24
	10	-6	-9	-9	-9	-11	-14	-19	-26
	12	-7	-9	-9	-9	-11	-15	-20	-27
2600	8	-6	-8	-10	-10	-11	-14	-17	-24
	10	-6	-9	-9	-9	-11	-14	-19	-26
	12	-6	-9	-9	-9	-11	-15	-20	-27
2800	8	-5	-9	-10	-10	-11	-14	-17	-24
	10	-6	-9	-9	-9	-11	-14	-19	-26
	12	-6	-9	-9	-9	-11	-15	-20	-28

• Sound power frequency spectrum calculated with this L_{wrel} are not licensed by AMCA.

Pressure Loss SPA - 1D

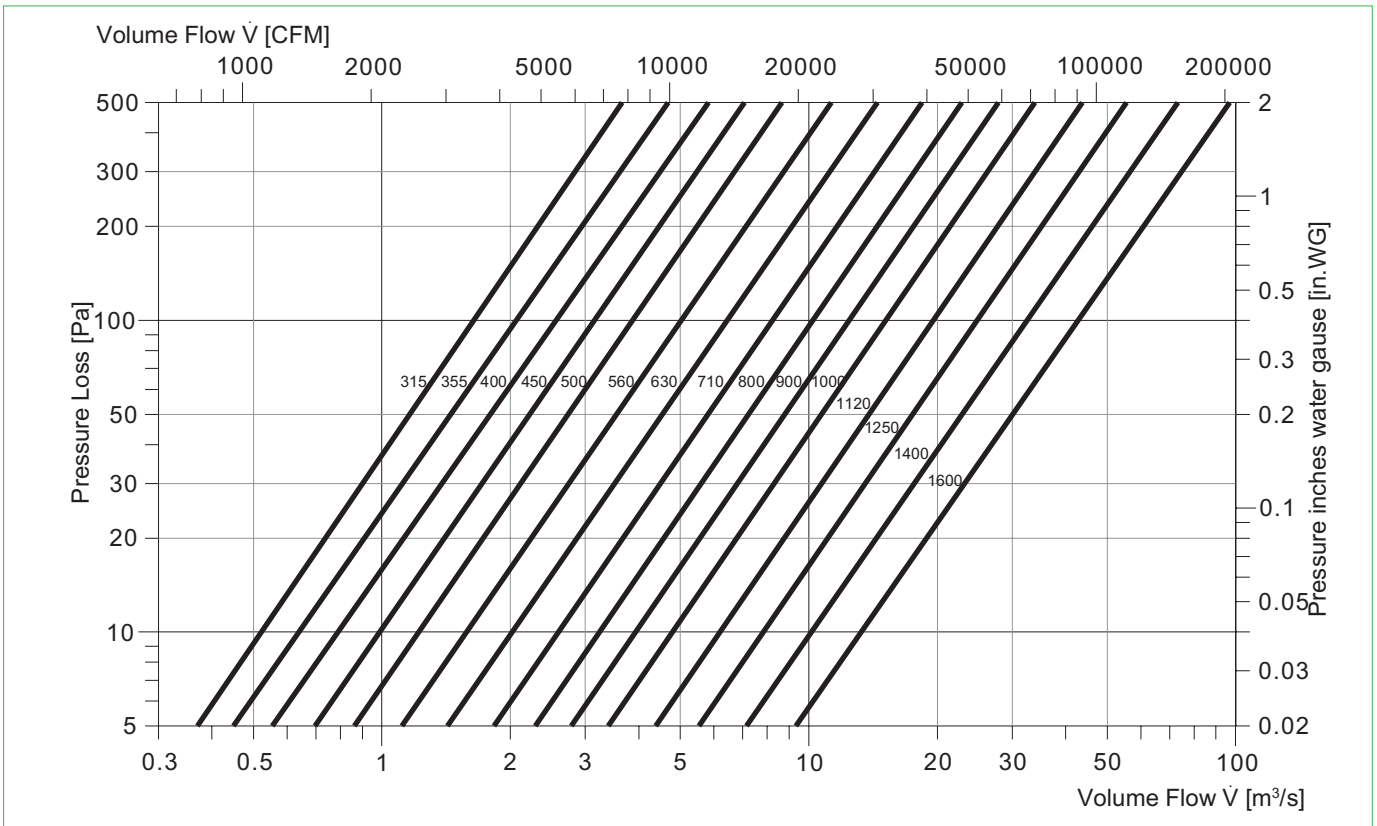

Pressure Loss SPA - 2D

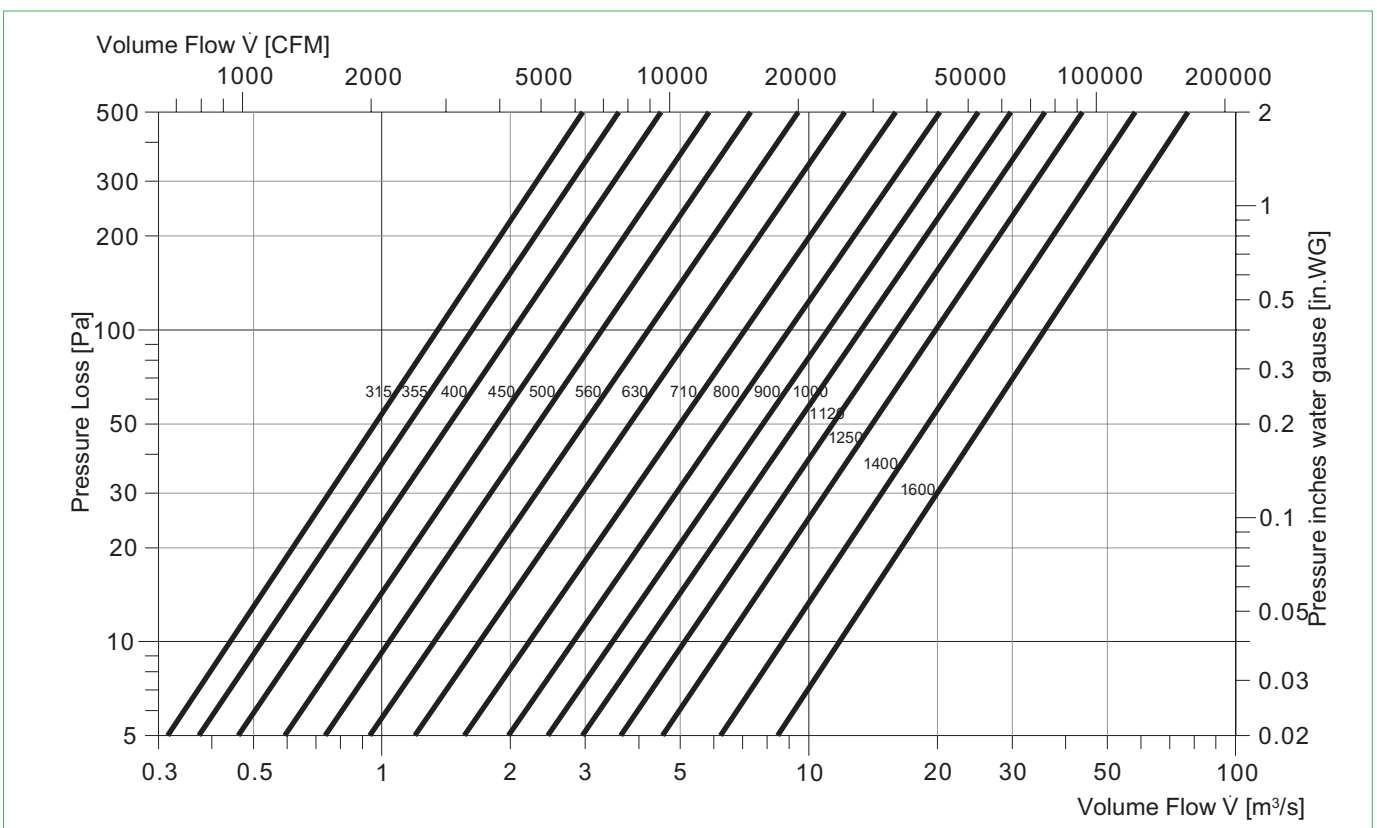

• Performance of sound attenuator are not licensed by AMCA International.

Wolter Sales Network

Inland

Ing. Günther Rößler
D-07619 Schkölen
Tel. (+49) 03 66 94 / 22 359
Fax (+49) 03 66 94 / 22 357
guenther.roessler@wolterfans.de

Mattias Industrievertretungen
D-16259 Bad Freienwalde
Tel. (+49)03344/301994
Fax (+49)03344/301996
thomas.mattias@wolterfans.de

Industrieservice Drexler
D-49080 Osnabrück
Tel. (+49) 0 541 / 20 04 88 3
Fax (+49) 0 541 / 20 04 88 4
wolfgang.drexler@wolterfans.de

Burkhardt Projekt GmbH
D-67583 Guntersblum
Tel. (+49) 0 62 49 / 82 01
Fax (+49) 0 62 49 / 88 58
info@bp-wolter.de

Friedrich Glock
D-97980 Bad Mergentheim
Tel. (+49) 0 79 31 / 37 44
Fax (+49) 0 79 31 / 28 58
friedrich.glock@wolterfans.de

Europe

Danmark:

Air-Con Danmark A/S
DK-8400 Ebeltoft
Tel. (+45)086/345111
Fax (+45)086/345810
jbj@air-con.dk

Hungary:

Air-Technik Légtechnikai Kft.
HU-2040 Budaörs
Tel. (+36)023/428533
Fax (+36)023/428544
bp.air-technik@troges.hu

Ireland:

Finheat Ltd.
IE-Dublin 12, Walkinstown
Tel. (+353)01/4564066
Fax (+353)01/4564071
sales@finheat.com

Lithuania:

JSC Saldos Prekyba
LT-78109 Siauliai
Tel. (+37)041/540212
Fax (+37)041/596176
prekyba@saldai.lt

Netherlands:

AirFan B. V.
NL-7442 CX Nijverdal
Tel. (+31)054/8366366
Fax (+31)054/8365320
ventilatie@airfan.nl

Rucon B. V. Ventilatoren
NL-3840 AG Harderwijk
Tel. (+31)034/1411670
Fax (+31)034/1411690
verkoop@rucon.nl

Österreich:

Wolter Werksvertretung Österreich
A-4040 Linz
Tel. (+43) 07 32 / 75 77 07
Fax (+43)07 32 / 75 77 07 75
wolter.linz@aon.at

Poland:

Wentoprodukt
44-100 Gliwice
Tel. (+48)32 331-34-24
Fax (+48)32 729-76-53
biuro@wentoprodukt.pl

Portugal:

Safe Park Ventilação Industrial Lda.
P-2675-240 Odivelas
Tel. (+351) 21 93 / 75 265
Fax (+351) 21 93 / 86 061
safepark@netcabo.pt

Russia:

Euroclimat-Prof
RU-107082 Moskau
Tel. (+7) 4 95 / 97 57 530
Fax (+7) 4 95 / 97 57 530
gso@euroclimat.ru

Schweiz:

Anson AG Zürich
CH-8055 Zürich
Tel. (+41) 0 44 / 46 11 111
Fax (+41) 0 44 / 46 13 111
info@anson.ch

Ventra Technik AG
CH-8599 Salmsach
Tel. (+41) 0 71 / 46 11 447
Fax (+41) 0 71 / 46 11 448
ventra@bluwin.ch

Turkey:

Air Trade Centre Ltd Sti Türkiye,
TR-34418 Seyrantepe / Istanbul
Tel. (+90) 02 12 / 28 34 510
Fax (+90) 02 12 / 27 83 964
atc.turkey@airtradecentre.com

United Kingdom:

Wolter UK Ltd.
GB-B37 7UQ Solihull
Tel. (+44) 01 21 / 63 55 390
Fax (+44) 01 21 / 63 55 391
info@wolteruk.com

Middle East and North Africa

Egypt:

Tiba Engineering Industries Co.
Nasr City, Cairo
Tel. (+2) 02 / 40 22 866
Fax (+2) 02 / 40 44 771
tibaengineering@manz-group.com

Israel:

Lea Ventilation Industries Ltd.
IL-27113 Kiriyat-Bialik, Israel
Tel. (+972) 0 48 / 76 23 57
Fax (+972) 0 48 / 76 20 51
mail@lea.co.il

United Arab Emirates, Kuwait,

Lebanon:
Wolter Ventilation LLC
Energy International
P.O. Box 3562 Sharjah, UAE
Tel. (+971) 06 / 53 43 477
Fax (+971) 06 / 53 43 756
energysh@emirates.net.ae

Asia

China Mainland:

Taizhou Wolter Ventilation Co. Ltd.
Hengjie, Luqiao District
Taizhou City, Zhejiang
Tel. (+86) 576 / 26 22 666 (26 52 888)
Fax (+86) 576 / 26 56 830

Hongkong:

Wolter Asia Ltd.
Hong Kong
Tel. (+852) 0 24 / 56 01 98
Fax (+852) 0 24 / 56 02 90
info@wolter.com.hk

India:

Wolter Ventilators India Pvt. Ltd.
867 D, Block-A, Sushant Lok, Phase-I,
Gurgaon - 122009 (Haryana)
Tel. +91 124 2577797, 4261001-3
sales@wolterindia.in

Indonesia:

PT. Agung Kipas Kastara.
ID-14440 Jakarta Indonesia
Tel. +62 (0) 21 / 6667 6925, 6667 6926
Fax +62 (0) 21 / 6667 6927
indowolter@cbn.net.id

Korea:

Kaceco-Wolter
14-1, Dang-dong, Gunpo-shi, Gyeonggi-do
Tel. +82 (0) 31 / 4773 104
Fax +82 (0) 31 / 4773 132
wolter@kaceco.com / info@kaceco.com

Malaysia:

Vibrantech (M) Sdn Bhd.
47200 Petaling Jaya Selangor, Malaysia
Tel. +603 (0) 7847 3500
Fax +603 (0) 7847 3380
sales@vibrantech-sb.com

Singapore:

Wolter Pte. Ltd.
SG-569738 Singapore
Tel. (+65) 0 63 / 52 95 48
Fax (+65) 0 63 / 52 95 47
info@wolterfans.com.sg

Sri Lanka:

Sirocco Air Technologies (Pvt) Ltd.
28/12, Gemunu Mawatha, Kotuwegoda,
Rajagiriya, Sri Lanka
Tel. +94 11 7 392 010
Fax +94 11 7 392 015
suren@sairt.com

Taiwan:

Waxlink International Co., Ltd.
8F No. 218 Roosevelt Rd., Sec. 6
Taipei, Taiwan
Tel. (+886) 02 / 89 32 11 96
Fax (+886) 02 / 89 32 11 97
waxlink.tech@msa.hinet.net

Thailand:

Wolter Ventilation Co., Ltd.
Thamai Kratumban Samutsakorn 74110
Thailand
Tel. +66 (0) 3486 6555
Fax +66 (0) 3486 6599
natiphan@wolterfan.com

Australia

The Sydney Fan Company.
NSW 2147, Sydney, Australia
Tel. +61 (0) 2 / 9624 4000
Fax +61 (0) 2 / 9624 4100
sales@thesydneyfancompany.com

Wolter GmbH

Maschinen-und Apparatebau KG

Am Wasen 11
D-76316 Malsch / Germany
Tel. +49 (0) 7204/9201-0
Fax +49 (0) 7204/9201-11
www.wolter.eu
info@wolter.eu





Reference: **A09-TH**, V2017/May, Printed in May, 2017