

AND AXIAL FLOW FANS *with adjustable blades*
as standard fans, explosion proof design and smoke fans



rosenberg [®] ECOFT 

Warranty Guidelines

The customer is responsible for the project design, selection and operation of the fans. The supplier gives warranty for faulty products, excluding further claims, in accordance with valid terms and conditions of business.

Warranty will not be given in the following instances:

(I) Unfitted or inappropriate usage, incorrect mounting or faulty installation by the purchaser or a third party, normal wear and tear, incorrect or negligent handling, improper maintenance, unsuitable operating material, unsuitable ground and chemical, electrochemical or electrical influence as long as they are not the responsibility of the supplier.

(II) If the goods delivered from the manufacturer are faulty, the customer has the right to receive a replacement or replacement of the faulty parts to the maximum value of the purchase price. The manufacturer also has the right to get the product repaired within a reasonable time period. The manufacturer must be informed immediately in the case of damage.

(III) The obligation to replace additional faults is herewith excluded. Our general terms of business are the basis for all further agreements for example: time periods to repair or replace. The general terms of business are available on our website www.rosenberg.eu or direct from one of our sales representatives.

The Rosenberg Group

Since the company's foundation in 1981, **Rosenberg Ventilation GmbH** has developed into an important centre for the heat, ventilation and air conditioning industry in Europe through the development and manufacturing of speed controllable external rotor motors, fans, blowers, air handling units, and motor speed control devices.

Our aim is for high quality production backed by our top class service for our clients. Thus a continuous flow of information and good cooperation between you, dear customers, and us is important to jointly achieve a continuous evolution of our products and their quality.

Modern test chambers and equipment, as well as computer controlled production handled by self-responsible working teams are part of our philosophy, as the control of high quality and environmental protection measures.

60% of Rosenberg's total revenue is in export sales. Currently Rosenberg has 240 employees at the company's headquarter in Kunzelsau and more than 1,400 worldwide. Further production facilities are located in Glaubitz(GER), Waldmunchen (GER), Hungary, Czech Republic, Slovakia France, Italy and China.



Headquarter in Kunzelsau, Germany

Axial fans AND series with adjustable blades.

Technical Description

Axial fans with adjustable blades cover a wide capacity range due to their large variation possibilities with hub relation, number of blades and blade angle. With the Rosenberg AND series, pressure increases up to 1200Pa and volumes up to 85,000cmh can be realized.

The allowed temperatures of the conveyed mediums are from -20°C up to +80°C as a standard, following description of motor manufacturer. Special motors for higher temperatures are available upon request.

The standard air flow direction is pressured over the motor. To reverse airflow direction, blade position must be rotated 180° and the direction of motor rotation must be changed.



The fans are suitable for vertical and horizontal installation. The fans are designed for installation in a ventilation system and therefore supplied without protection guard as a standard.

Casings

The casings are manufactured from mild steel with hot dipped galvanized finishing after manufactured as an anti-corrosive measure and for longer life as a standard. Every casing comes with defined flange master gauge for holes to ensure an easy connection to the duct system. The centrally mounted motor is wired via a flexible weatherproof cable to an external located IP55 protected terminal box on the fan casing. The fan casing have a minimum thickness of 3mm on fan sizes up to 1120mm and a minimum of 4.5 mm for larger fans.

In the long casing version, the casing, the motor and the blades are covered. In the short casing version, the motor juts out. Two stage axial fans, coupling of two long casing fans are also available upon request.

Impellers

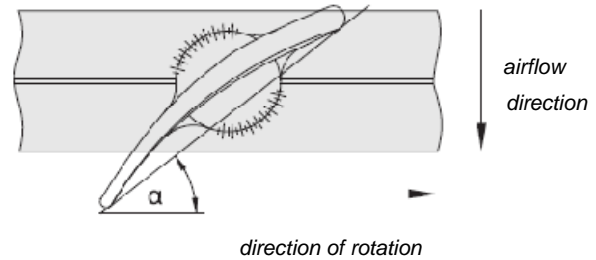

The axial impellers are balanced on quality level G 6.3 according to DIN ISO 1940. The hubs of chilled casting aluminium are made in two parts and have removal drilling for easy dismounting of the impellers. The profile blades are made of aluminium die cast. In standstill the blades angles are adjustable. If the blade angle α is adjusted after delivery, the power requirement must be checked for overload of the motor. The impeller has to be balanced after blade adjustment. The blade angle is measured on the wing tip. The number of blades is variable which expands the performance range and allows any operation. Aluminium alloy LM6M blades are use in smoke and fume extract up to 400°C.

Rosenberg supplies glass reinforced polypropylene blades for fan diameter 560 and below for normal class F motor as a standard. The blades are injection moulded UV stabilised anti-static, black color and with the same curve profile as the aluminium blades. Temperature range from -10°C to +80°C. The chemical resistance of polypropylene make the fans suitable to use in area exposed to some diluted acids and alkali, oily and with various organics such as alcohols, ketones aromatic and chlorinated environment.

Motors



3-phase IEC standard motors of type B3 with protection class IP55, insulation class F in 2-, 4-, 6- or 8 pole execution are used. Pole changeable, voltage controllable, inverter motors and single phase A.C. motors or higher airflow temperatures are available upon request. Motor used comply with electrical standard BS5000 and IEC publication 34-1, mechanical standard BS4999 and IEC publication 72.

Special Design:

Explosion Proof

AND axial fans are available as explosion proof type. The maximum shaft power is limited to 15kW. The explosion proof fans are in accordance to ATEX standards with the marking II2GclIBT3X. They are suitable for use in and for conveying in Zone 1 & 2. Exe or Exd explosion proof motor, depending on the application can be used.



Anti static FRP blades with aluminium hub are used for fan diameter 315 to 560mm as a standard. Aluminium impeller with anti-spark track are used for fan diameter 630mm and above. The aluminium anti-spark track isolate the steel casing from the blades, thus preventing the possibility of a static electric spark. Anti static FRP blades with aluminium hub for 630mm diameter and above are also available.

Due to the larger annular gap of explosion proof fans, a power loss (5% in volume flow and 15% in pressure) must be taken into consideration during selection.

Smoke Extract

AND axial fans are suitable for smoke extract system. Only aluminium impellers are used. Fan casings are made from mild steel with hot dipped galvanized finishing as standard. Special high temperature rated for 250°C two hours, one time continuous run, class H insulation, IP55 motors are used. For higher temperature range, please consult our sales representatives.



Epoxy Coating

Epoxy coating on casing is available on special request. The fans are painted with protective epoxy coating paints in situations where they are exposed to chemical solvents, salt water and other corrosive atmospheric conditions.

Optional Features

Reverse Direction

The standard direction of flow is Form B, where air passes through the impeller over the motor. Reverse flow, Form A can be provided on request (for 3 phase motor only). The resulting performances in reverse direction are:

- Volume reduced by 30%.
- Pressure reduced by 50%.
- Power reduced by 25%.

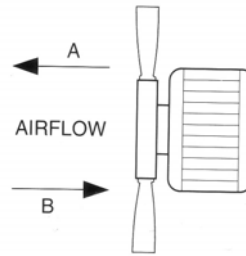

The AMCA Certified Ratings Seal does not apply to performance of reverse direction.

Guide Vanes

Up stream or Down stream guide vanes can be incorporated to increase the fan performance.

Up stream (or inlet) guide vanes create a swirl effect in the the opposite direction to the impeller rotation. It enables the following fan performance increases:

- Pressure 25%.
- Volume flow 20%
- Motor kw 40%.

Down stream (or Outlet) guide vanes act in the opposite direction to the swirl from the impeller and straighten the discharge air, enabling an improvement in pressure capacity:

- Pressure 20%.
- Volume flow 0%
- Motor kw 0%.

The AMCA Certified Ratings Seal does not apply to performance of guide vanes.

Two-Stage

A contra-rotating two stage axial fan consists of two single stage opposite handed impellers rotating in opposite directions. The contra-rotating system develops approximately 2 to 3 times the static pressure of a single stage impeller system of the same diameter and speed. The two stage system uses 5 to 10% less power and is quieter than a single stage system producing the same work at the same diameter. The air flow can be regulated by idling one stage. A flow reduction of 35% and a power reduction of 50% is possible without losses.

If necessary more stages can be added if pressure demands are higher than a two stage system can meet.

The AMCA Certified Ratings Seal does not apply to performance of two stage axial fans.

Performance Curves

Performance curves and technical specifications are based upon tests carried out in accordance to AMCA 210-99 standards by an independence laboratory.

The ratings shown are based on tests and procedures performed in accordance with AMCA Publication 211 and and comply with the requirements of the AMCA Certified Ratings Program. Performance certified is for installation type D - Ducted inlet, Ducted outlet. Performance rating do not include the effects of appurtenances (accessories).

The curves are valid for air with a density of 1.2kg/m³ at a temperature of 20^oC. The curves in this catalogue shows the increase of the static and the dynamic pressure in Pascal (Pa) as a function of the airflow in cubic metre per hour (m³/h).

Comparatively standards are ISO 5801, BS 848 Part 1 and DIN 24163.



Sound Level

The sound ratings shown on the fan curves are based on tests procedures performed in accordance with AMCA Publication 311 and comply with the requirements of the AMCA Certified Ratings Program.

The values shown are for inlet Lwi A sound power levels for installation type D: Ducted inlet, Ducted outlet. The ratings include the effects of duct end correction.

The A-weighted sound rating shown have been calculated as per AMCA International Standard 301.



Rosenberg East Asia Pte Ltd certifies that the Axial fans - AND Series shown herein are licensed to bear the AMCA Seal. The ratings shown are based on tests and procedures performed in accordance with AMCA Publication 211 and AMCA Publication 311 and comply with the requirements of the AMCA certified Ratings Program.

The AMCA Certified Ratings Seal applies to air and sound performance for Model AND315 to AND1250.

The AMCA Certified Ratings Seal applies to the Fan Efficiency Grade for Model AND500 to AND1250.

The Ratings Seal applies to sound and air performance as shown in our published catalog.

Rosenberg East Asia Pte Ltd is a member of the Air Movement and Control Association International Inc.

The International Authority on Air System Components.

Sound Level Information

The sound power levels shown on the fan curves are for inlet L_{wi} A scale for installation type D: ducted inlet, ducted outlet. Ratings include the effects of ducted end correction.

If the sound power frequency spectrum is needed, for example, the design of sound attenuators, the A-rated sound power levels at particular octave band frequency L_{WA} can be calculated by subtracting the relative sound level L_{wrel}.

$$L_{WA} = L_{wi} - L_{wrel}$$

The acoustic values of the inlet side can be used for the outlet side of the fans as well.

The sound pressure level at the inlet at 1m distance in low reflexion installation can be obtained by deducting 11dB from the sound power level at the inlet side. The sound pressure difference from 1m to distance a is obtained as follows:

$$L_p = 10 * \log (1/a).$$

Please note that reflections and room characteristics as well as natural frequencies influence the size of the sound pressure level differently.

Sound power frequency spectrum calculated with this L_{wrel} are not licensed by AMCA.

Relative Sound Power Frequency Spectrum (L_{wrel}) [dB]

Fan Diameter (mm)	63 Hz	125 Hz	250 Hz	500 Hz	1000 Hz	2000 Hz	4000 Hz	8000 Hz
315	-16	-10	-8	-6	-6	-9	-13	-21
400	-21	-12	-7	-6	-8	-11	-16	-23
500	-20	-13	-9	-6	-6	-7	-11	-19
560	-21	-14	-8	-6	-6	-8	-13	-20
630	-23	-16	-9	-6	-5	-7	-12	-19
710	-27	-16	-8	-7	-6	-8	-13	-20
800	-29	-19	-9	-6	-5	-8	-13	-20
900	-31	-19	-8	-6	-5	-9	-14	-20
1000	-20	-9	-8	-6	-7	-11	-15	-22
1120	-26	-14	-8	-5	-6	-11	-15	-19
1250	-25	-15	-9	-5	-5	-9	-14	-20

dB A-Weighting Correction

Frequency (Hz)	63	125	250	500	1000	2000	4000	8000
A-Weighting	-25.5	-15.5	-8.5	-3.0	0.0	1.0	1.0	-1.0

Correction For Distance

metre	dB
15	-35
	-34
	-33
	-32
10	-31
9	-30
8	-29
7	-28
	-27
6	-26
5	-25
	-24
4	-23
	-22
3	-21
	-20
	-19
	-18
2	-17
	-16
	-15
1.5	-14
	-13
	-12
1	-11
	-10

Decibel Addition

If the levels to be added differ by	the total is equal to the larger level plus
dB	dB
0 or 1	3
2 or 3	2
4 to 9	1
10 or more	0

Summation of Sound Sources

Sound of several equal sources, can be added by

$$L_z = L_1 + 10 * \log (z)$$

whereby :

z = number of sources

L₁ = sound level of a single source

L_z = resulted level

Product Code Identification

Standard Range from 315 to 710

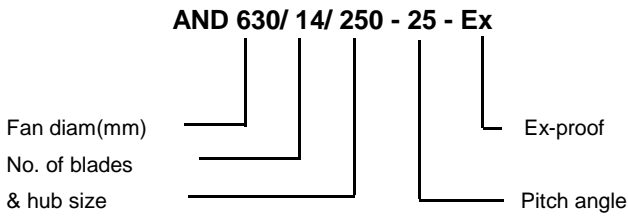

Larger Range from 800 to 1250

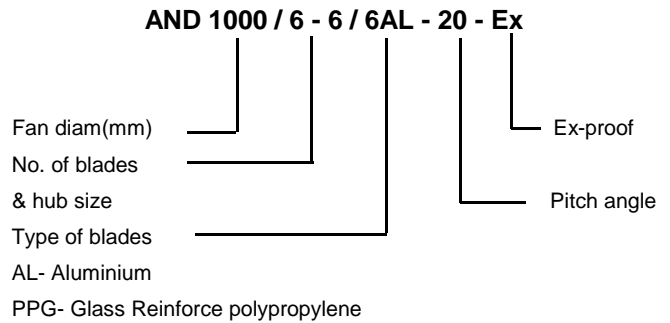

Fluid Flow Rules Of Operation For Fans

Speed variation at constant fan size and constant density :

The volume flow changes proportional to speed

$$V_1 / V_2 = n_1 / n_2$$

All pressures (static, dynamic and total) change square of the speed

$$p_1 / p_2 = (n_1 / n_2)^2 = (V_1 / V_2)^2$$

The power requirement changes cube to the speed

$$P_1 / P_2 = (n_1 / n_2)^3 = (V_1 / V_2)^3$$

Changes in the density at constant speed (or change of the kelvin temperature at a constant flow medium):

The volume flow is not affected

$$V = \text{const.}$$

All pressures change proportionately to the density *

$$p_1 / p_2 = \alpha_1 / \alpha_2 = T_2 / T_1$$

The power requirement changes proportionately to the density

$$P_1 / P_2 = \alpha_1 / \alpha_2 = T_2 / T_1$$

$$* T_1 = T_o + t_1 = 273.15 \text{ K} + t_1$$

$$T_2 = T_o + t_2 = 273.15 \text{ K} + t_2$$

In the case of changes in the wheel diameter of geometrically similar wheels at constant speed:

The volume flow changes cube to the wheel diameter

$$V_1 / V_2 = (D_1 / D_2)^3$$

All pressures (static, dynamic and total) change proportionately to the square of the wheel diameter

$$p_1 / p_2 = (D_1 / D_2)^2$$

The power requirement changes proportionately to the fifth power of the wheel diameter

$$P_1 / P_2 = (D_1 / D_2)^5$$

Fan Efficiency Grade (FEG).



Certified FEGs are determined in accordance with AMCA 205-10 Energy Efficiency Classification for fans. In conjunction with AMCA 211-05 (Rev. 3/11) Certified Ratings Program, Product Rating Manual for Fan Air Performance. This classification is based on fan peak (optimum) total efficiency for a given fan speed, fan size and application category. For the purpose of energy classification, the peak efficiency can be determined at a speed not higher than the maximum design speed of the fan.

The AMCA Certified Ratings Seal applies to the Fan Efficiency Grade (FEG) for AND series Axial fan model AND 500 to AND 1250 as shown in the table below only.

Fan Model No.	Fan Speed (rpm)	Fan Outlet Area (m2)	Fan Efficiency Grades (FEG)	Fan Model No.	Fan Speed (rpm)	Fan Outlet Area (m2)	Fan Efficiency Grades (FEG)
AND 500/10/150	2880	0.1963	FEG56	AND 560/14/250	1440	0.2463	FEG56
	1440				960		
	960				720		
	720						
AND 630/14/250	1440	0.3117	FEG56	AND 710/14/250	1440	0.3959	FEG63
	960				960		
	720				720		
AND 800/12-12/4AL	1440	0.5052	FEG60	AND 900/12-12/5AL	1440	0.6404	FEG63
	960				960		
	720				720		
AND 1000/6-6/6AL	1440	0.7885	FEG75	AND 1120/8-8/6AL	1440	0.9887	FEG71
	960				960		
	720				720		
AND 1250/8-8/6AL	1440	1.2233	FEG75				
	960						
	720						

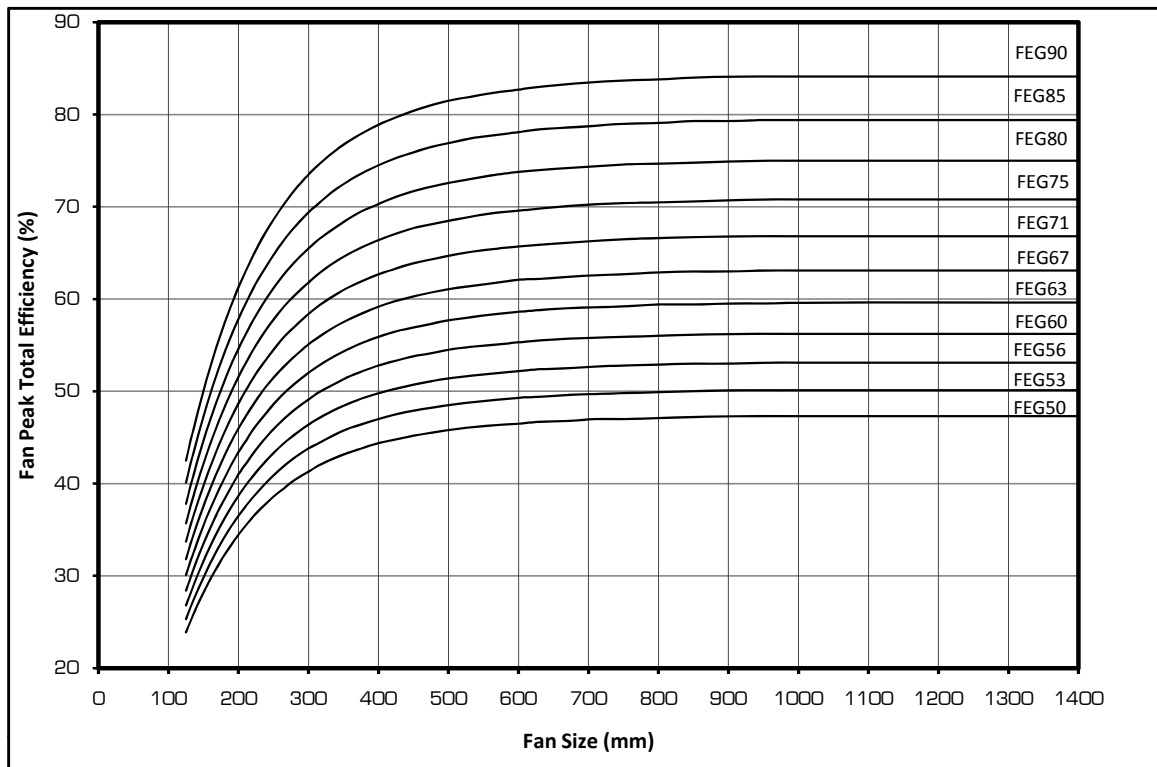

Fan Diameter (Nominal)	Motor Frame Size	A	B	C	D	E	F	G	H	J	K	Long Casing (kgs)	Short Casing (kgs)
		Inner Diam	Outer Diam	Long Casing	Short Casing	(max)	(thk)	Nos. Of Holes	Holes Diam	PCD Diam	Conduit Diam		
315	63	315	395	300	180	290	2	8	10	355	20	30	26
315	71	315	395	300	180	300	2	8	10	355	20	33	29
315	80	315	395	350	180	335	2	8	10	355	20	38	32
400	63	400	480	300	220	290	3	8	12	450	20	34	30
400	71	400	480	300	220	300	3	8	12	450	20	36	33
400	80	400	480	350	220	335	3	8	12	450	20	42	36
400	90	400	480	400	220	380	3	8	12	450	20	52	44
400	100	400	480	400	220	380	3	8	12	450	20	60	52
500	71	500	600	300	220	300	3	12	12	560	20	43	38
500	80	500	600	350	220	335	3	12	12	560	20	49	42
500	90	500	600	400	220	380	3	12	12	560	20	60	50
500	100	500	600	400	250	440	3	12	12	560	20	73	65
500	112	500	600	400	250	440	3	12	12	560	25	80	72
500	132	500	600	500	250	440	3	12	12	560	25	122	109
560	71	560	660	300	220	300	3	12	12	620	20	51	46
560	80	560	660	350	220	335	3	12	12	620	20	58	49
560	90	560	660	400	220	380	3	12	12	620	20	69	57
560	100	560	660	400	250	440	3	12	12	620	20	77	67
560	112	560	660	400	250	440	3	12	12	620	25	95	79
560	132	560	660	500	300	555	3	12	12	620	25	132	119
630	71	630	730	300	250	300	3	12	12	690	20	56	52
630	80	630	730	350	250	335	3	12	12	690	20	63	56
630	90	630	730	400	250	380	3	12	12	690	20	75	64
630	100	630	730	400	250	440	3	12	12	690	20	88	77
630	112	630	730	400	250	440	3	12	12	690	25	95	84
630	132	630	730	500	300	555	3	12	12	690	25	139	125
630	160	630	730	700	400	650	4	12	12	690	32	209	187
710	80	710	810	350	250	335	3	16	12	770	20	67	58
710	90	710	810	400	250	380	3	16	12	770	20	80	67
710	100	710	810	400	250	440	3	16	12	770	20	93	80
710	112	710	810	400	250	440	3	16	12	770	25	100	87
710	132	710	810	500	300	555	3	16	12	770	25	145	129
710	160	710	810	700	400	710	4	16	12	770	32	217	192
710	180	710	810	700	500	775	4	16	12	770	38	277	260

All dimensions in millimetre (mm).

Two times the casing length and weight for 2 stage fans.

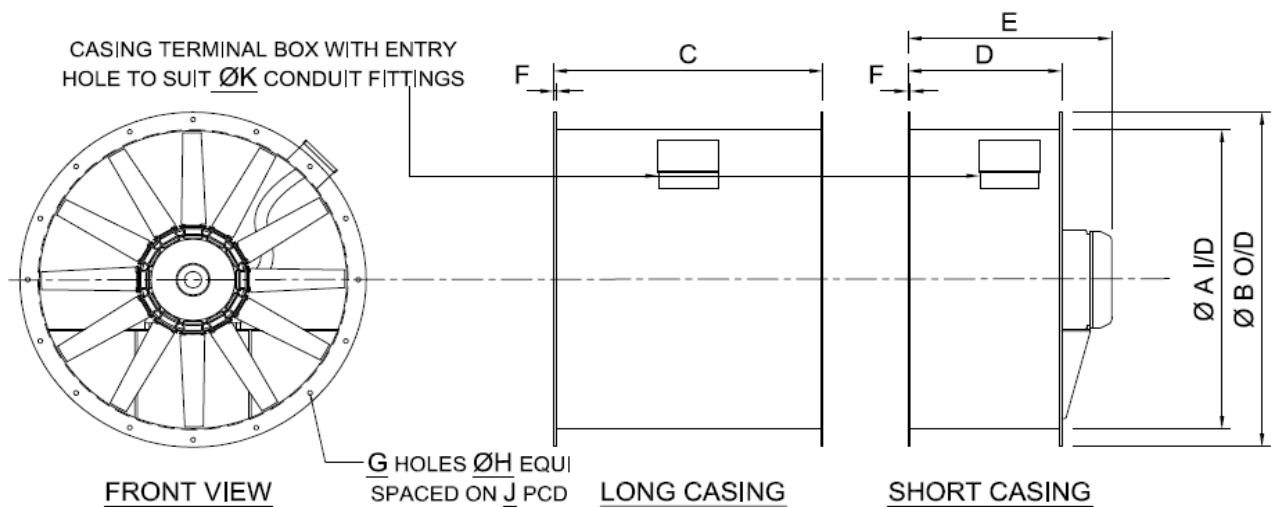

Dimensions

Fan Diameter (Nominal)	Motor Frame Size	A	B	C	D	E	F	G	H	J	K	Long Casing (kgs)	Short Casing (kgs)
		Inner Diam	Outer Diam	Long Casing	Short Casing	(max)	(thk)	Nos. Of Holes	Holes Diam	PCD Diam	Conduit Diam		
800	80	800	900	350	250	335	3	16	12	860	20	74	64
800	90	800	900	400	250	380	3	16	12	860	20	86	72
800	100	800	900	400	250	440	3	16	12	860	20	99	85
800	112	800	900	400	250	440	3	16	12	860	25	106	92
800	132	800	900	500	300	555	3	16	12	860	25	153	134
800	160	800	900	700	400	650	4	16	12	860	32	227	198
900	90	900	1000	400	250	380	4	16	15	970	20	96	80
900	100	900	1000	400	250	440	4	16	15	970	20	109	93
900	112	900	1000	400	250	440	4	16	15	970	25	116	100
900	132	900	1000	500	300	555	4	16	15	970	25	164	143
900	160	900	1000	700	400	710	4	16	15	970	32	240	208
900	180	900	1000	700	400	710	4	16	15	970	38	265	233
1000	100	1000	1100	400	300	440	4	16	15	1070	25	127	115
1000	112	1000	1100	400	300	455	4	16	15	1070	25	134	122
1000	132	1000	1100	500	300	570	4	16	15	1070	25	182	173
1000	160	1000	1100	700	420	725	4	16	15	1070	32	261	237
1000	180	1000	1100	700	500	775	4	16	15	1070	38	333	320
1000	200	1000	1100	800	550	840	5	16	15	1070	52	428	403
1000	225	1000	1100	1000	590	910	5	16	15	1070	52	530	481
1120	112	1120	1220	400	300	455	4	16	15	1175	25	160	145
1120	132	1120	1220	500	300	570	4	16	15	1175	25	212	182
1120	160	1120	1220	700	420	725	4	16	15	1175	32	297	255
1120	180	1120	1220	700	500	775	4	16	15	1175	38	357	327
1120	200	1120	1220	800	550	840	5	16	15	1175	52	455	417
1120	225	1120	1220	1000	590	910	5	16	15	1175	52	563	501
1120	250	1120	1220	1000	590	940	6	16	15	1175	52	667	605
1250	132	1250	1350	500	300	570	4	20	15	1320	25	249	206
1250	160	1250	1350	700	420	725	4	20	15	1320	32	346	286
1250	180	1250	1350	700	500	775	4	20	15	1320	38	406	364
1250	200	1250	1350	800	550	840	4	20	15	1320	52	511	457
1250	225	1250	1350	1000	590	910	4	20	15	1320	52	632	544
1250	250	1250	1350	1000	590	980	4	20	15	1320	52	835	747
1250	280	1250	1350	1200	700	1075	4	20	15	1320	52	1008	982

All dimensions in millimetre (mm).

Two times the casing length and weight for 2 stage fans.

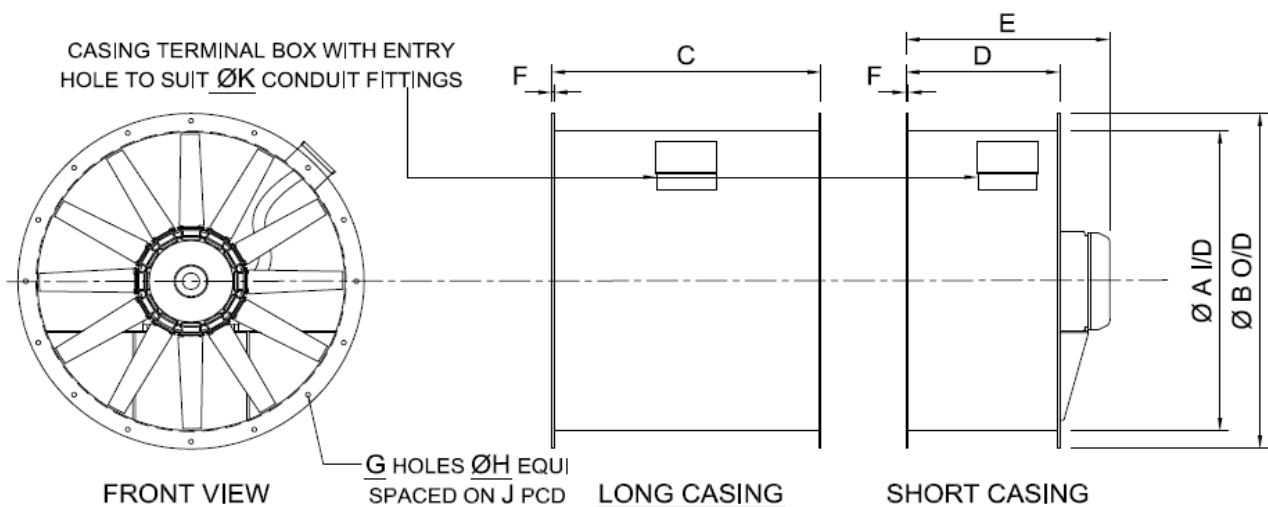

Motor Size (kW)	Poles	Motor Frame Size	Power	Full Load Current (ampere)
0.18	2 pole	63	230/1/50	1.60
0.37	2 pole	71	230/1/50	2.70
0.55	2 pole	71	230/1/50	3.90
0.75	2 pole	80	230/1/50	5.50
1.1	2 pole	80	230/1/50	6.60
1.5	2 pole	90L	230/1/50	9.60
2.2	2 pole	90L	230/1/50	15.40
0.18	4 pole	63	230/1/50	2.10
0.37	4 pole	71	230/1/50	3.20
0.55	4 pole	80	230/1/50	4.20
0.75	4 pole	80	230/1/50	5.10
1.1	4 pole	90L	230/1/50	7.80
1.5	4 pole	90L	230/1/50	9.30
2.2	4 pole	100L	230/1/50	12.70
0.18	6 pole	71	415/3/50	0.66
0.37	6 pole	80	415/3/50	1.16
0.55	6 pole	80	415/3/50	1.59
0.75	6 pole	90S	415/3/50	1.98
1.1	6 pole	90L	415/3/50	3.03
1.5	6 pole	100L	415/3/50	3.62
2.2	6 pole	112M	415/3/50	5.23
3	6 pole	132S	415/3/50	6.03
4	6 pole	132M	415/3/50	8.34
5.5	6 pole	132M	415/3/50	12.00
7.5	6 pole	160M	415/3/50	14.90
11	6 pole	160L	415/3/50	20.80
15	6 pole	180L	415/3/50	27.10
18.5	6 pole	200L	415/3/50	34.10
22	6 pole	200L	415/3/50	40.30
0.37	4 pole	71	415/3/50	1.03
0.55	4 pole	80	415/3/50	1.46
0.75	4 pole	80	415/3/50	1.76
1.1	4 pole	90S	415/3/50	2.58
1.5	4 pole	90L	415/3/50	3.26
2.2	4 pole	100L	415/3/50	4.66
3	4 pole	100L	415/3/50	6.06
4	4 pole	112M	415/3/50	8.09
5.5	4 pole	132S	415/3/50	11.00
7.5	4 pole	132M	415/3/50	13.60
11	4 pole	160M	415/3/50	20.10
15	4 pole	160L	415/3/50	26.70
18.5	4 pole	180M	415/3/50	33.20
22	4 pole	180L	415/3/50	39.30
30	4 pole	200L	415/3/50	51.90
37	4 pole	225S	415/3/50	66.00
45	4 pole	225M	415/3/50	78.70
55	4 pole	250S	415/3/50	93.50
75	4 pole	250M	415/3/50	124.00
90	4 pole	280SC	415/3/50	154.00
110	4 pole	280MC	415/3/50	187.00
0.37	2 pole	71	415/3/50	0.81
0.55	2 pole	71	415/3/50	1.21
0.75	2 pole	80	415/3/50	1.51
1.1	2 pole	80	415/3/50	2.21
1.5	2 pole	90S	415/3/50	2.91
2.2	2 pole	90L	415/3/50	4.19
3	2 pole	100L	415/3/50	5.49
4	2 pole	112M	415/3/50	7.33
5.5	2 pole	132S	415/3/50	10.2
7.5	2 pole	132S	415/3/50	13.3
11	2 pole	160M	415/3/50	19.7
15	2 pole	160M	415/3/50	25.2
18.5	2 pole	160L	415/3/50	30.8

Motor Size (kW)	Poles	Motor Frame Size	Power	Full Load Current (ampere)
0.75/0.11	2/4 poles	80	415/3/50	1.63/ 0.49
1.5/0.12	2/4 poles	90L	415/3/50	3.17/ 1.00
2.2/0.37	2/4 poles	100L	415/3/50	4.05/ 0.94
3.6/0.6	2/4 poles	112M	415/3/50	6.83/ 1.92
4/1	2/4 poles	112M	415/3/50	7.98/ 2.98
5.5/1.2	2/4 poles	132S	415/3/50	10.58/ 3.27
7.5/1.8	2/4 poles	132S	415/3/50	13.85/ 4.13
11/2.75	2/4 poles	160M	415/3/50	19.62/ 6.25
15/3.75	2/4 poles	160L	415/3/50	25.29/ 7.48
18.5/4.6	2/4 poles	160L	415/3/50	31.54/ 9.33
22/5.5	2/4 poles	180L	415/3/50	46.25/ 9.4
0.18/0.1	4/6 poles	80	415/3/50	0.65/ 0.5
0.37/0.18	4/6 poles	90S	415/3/50	1.07/ 0.74
0.55/0.18	4/6 poles	90L	415/3/50	1.23/ 0.82
0.75/0.28	4/6 poles	90L	415/3/50	1.63/ 1.11
1.1/0.33	4/6 poles	100L	415/3/50	2.21/ 0.94
1.5/0.5	4/6 poles	100L	415/3/50	3.17/ 1.6
2.2/0.75	4/6 poles	112M	415/3/50	4.62/ 2.6
3/0.98	4/6 poles	112M	415/3/50	6.44/ 2.88
4/1.5	4/6 poles	132S	415/3/50	9.04/ 3.56
5.6/2.2	4/6 poles	132M	415/3/50	10.38/ 4.66
7.5/2.2	4/6 poles	132M	415/3/50	14.42/ 4.66
11/3.7	4/6 poles	160L	415/3/50	19.81/ 7.42
15/5	4/6 poles	180M	415/3/50	29.33/ 10.29
18.5/5.5	4/6 poles	180L	415/3/50	36.54/ 10.77
22/7.5	4/6 poles	200L	415/3/50	48.46/ 14.13
30/9	4/6 poles	200L	415/3/50	59.81/ 16.35
37/11	4/6 poles	225M	415/3/50	68.75/ 23.37
45/13.5	4/6 poles	250S	415/3/50	78.85/ 23.85
55/16.5	4/6 poles	250M	415/3/50	97.12/ 29.23
75/22	4/6 poles	280M	415/3/50	126.92/ 42.31
0.37/0.09	4/8 poles	80	415/3/50	1.29/0.5
0.55/0.13	4/8 poles	80	415/3/50	1.83/ 0.67
0.75/0.18	4/8 poles	80	415/3/50	2.02/ 0.72
1.5/0.37	4/8 poles	90L	415/3/50	4.04/ 1.39
2.2/0.55	4/8 poles	100L	415/3/50	4.63/ 1.45
4/1.0	4/8 poles	112M	415/3/50	7.79/ 2.6
5.5/1.37	4/8 poles	132S	415/3/50	10.77/ 2.87
7.5/1.87	4/8 poles	132M	415/3/50	13.56/ 4.23
11/2.75	4/8 poles	160M	415/3/50	21.44/ 6.25
15/3.75	4/8 poles	160L	415/3/50	27.4/ 7.52
18.5/4.62	4/8 poles	180M	415/3/50	32.88/ 10.38
22/5.5	4/8 poles	200L	415/3/50	38.46/ 12.21
30/7.5	4/8 poles	200L	415/3/50	52.88/ 17.02
45/11.25	4/8 poles	225M	415/3/50	88.85/ 25.67

Matching Flanges

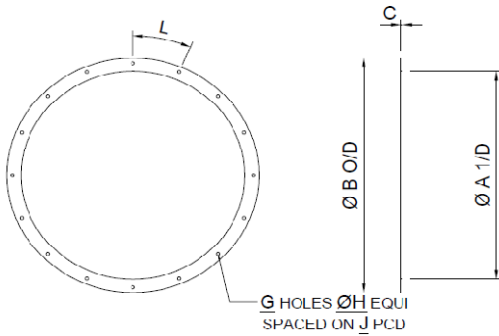

Size	A	B	C	G	H	J	L	WT
						PCD	Deg	(kgs)
315	318	397	4.5	8	10	355	45°	0.7
400	403	482	4.5	8	12	450	45°	1.1
500	503	606	4.5	12	12	560	30°	2.2
560	563	666	4.5	12	12	620	30°	2.6
630	633	736	4.5	12	12	690	30°	3.0
710	713	816	4.5	16	12	770	22.5°	3.4
800	803	906	4.5	16	12	860	22.5°	3.7
900	903	1006	4.5	16	15	970	22.5°	6.0
1000	1003	1106	4.5	16	15	1070	22.5°	6.5
1120	1123	1226	4.5	16	15	1175	18°	7.3
1250	1255	1359	6	20	15	1320	18°	8.0

Material & finish: Steel , hot dipped galvanized.

All dimensions in millimetre (mm).

Mounting Feet

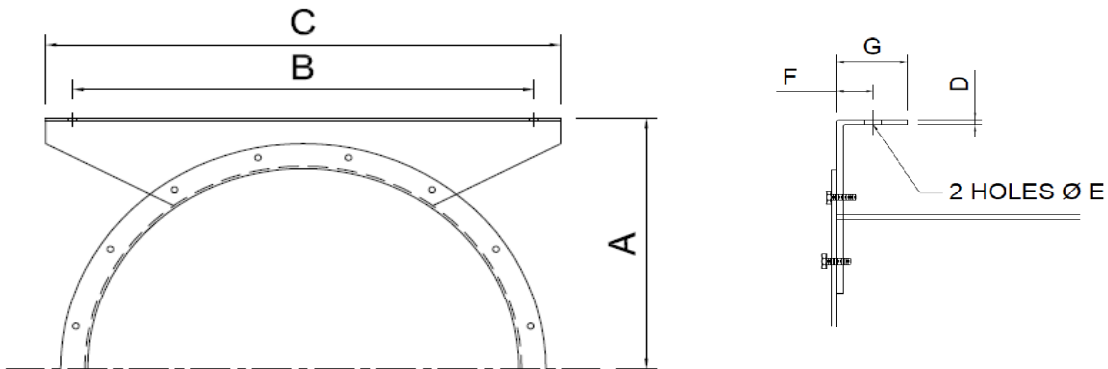

Size	A	B	C	D	E	F	G	WT
								(kgs)
315	200	393	445	3	9	23	40	1.0
400	250	478	530	3	9	27.5	50	1.5
500	315	580	655	3	11	27.5	50	2.5
560	355	620	700	3	11	32	60	4.0
630	400	685	785	3	11	32	60	5.0
710	450	770	860	3	11	32	60	5.5
800	500	860	955	3	11	32	60	6.0
900	560	970	1055	3	11	36	70	9.0
1000	630	1070	1155	4.5	13	36	70	12.0
1120	705	1175	1280	4.5	13	36	70	16.0
1250	780	1320	1420	4.5	13	36	70	19.0

Material & finish: Steel , hot dipped galvanized.

All dimensions in millimetre (mm).

INLET CONE

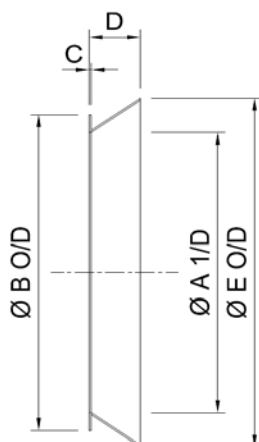

Size	A	B	C	D	E	PCD	Holes	WT
							Diam	(kgs)
315	315	391	3	55	400	355	10	2.0
400	400	476	3	70	510	450	12	3.0
500	500	600	3	90	640	560	12	5.0
560	560	660	3	100	715	620	12	6.0
630	630	730	3	110	800	690	12	9.0
710	710	810	3	125	890	770	12	11.0
800	800	900	3	135	995	860	12	13.0
900	900	1000	3	150	1110	970	15	18.0
1000	1000	1100	4.5	165	1230	1070	15	23.0
1120	1120	1220	4.5	185	1377	1175	15	28.0
1250	1250	1350	4.5	205	1525	1320	15	32.0

Material & finish: Steel , hot dipped galvanized.

All dimensions in millimetre (mm).

AND 315/10/150 -
315 mm Diameter 2880 Rpm 50 Hz



Performance certified is for installation type D - Ducted Inlet, Ducted Outlet.
 Performance rating do not include the effects of appurtenances (accessories).
 Values shown are for inlet LW_i A sound power levels for installation type D : ducted inlet, ducted outlet.
 Ratings include the effects of duct end correction.
 The A-weighted sound ratings shown have been calculated per AMCA International Standard 301.
 The AMCA Certified Ratings Seal applies to air and sound performance ratings only.

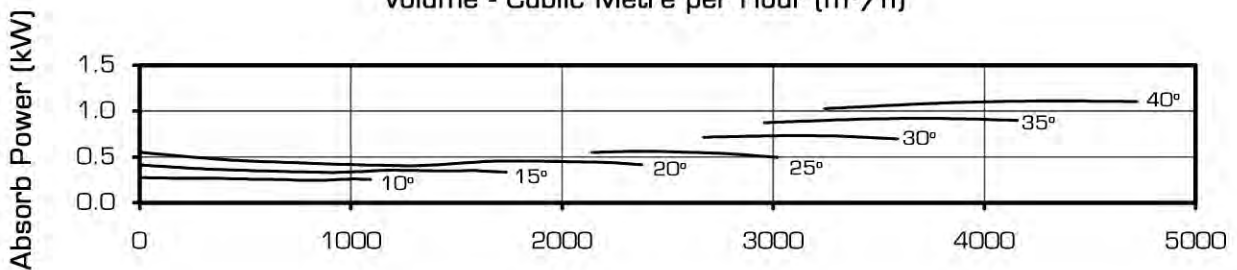
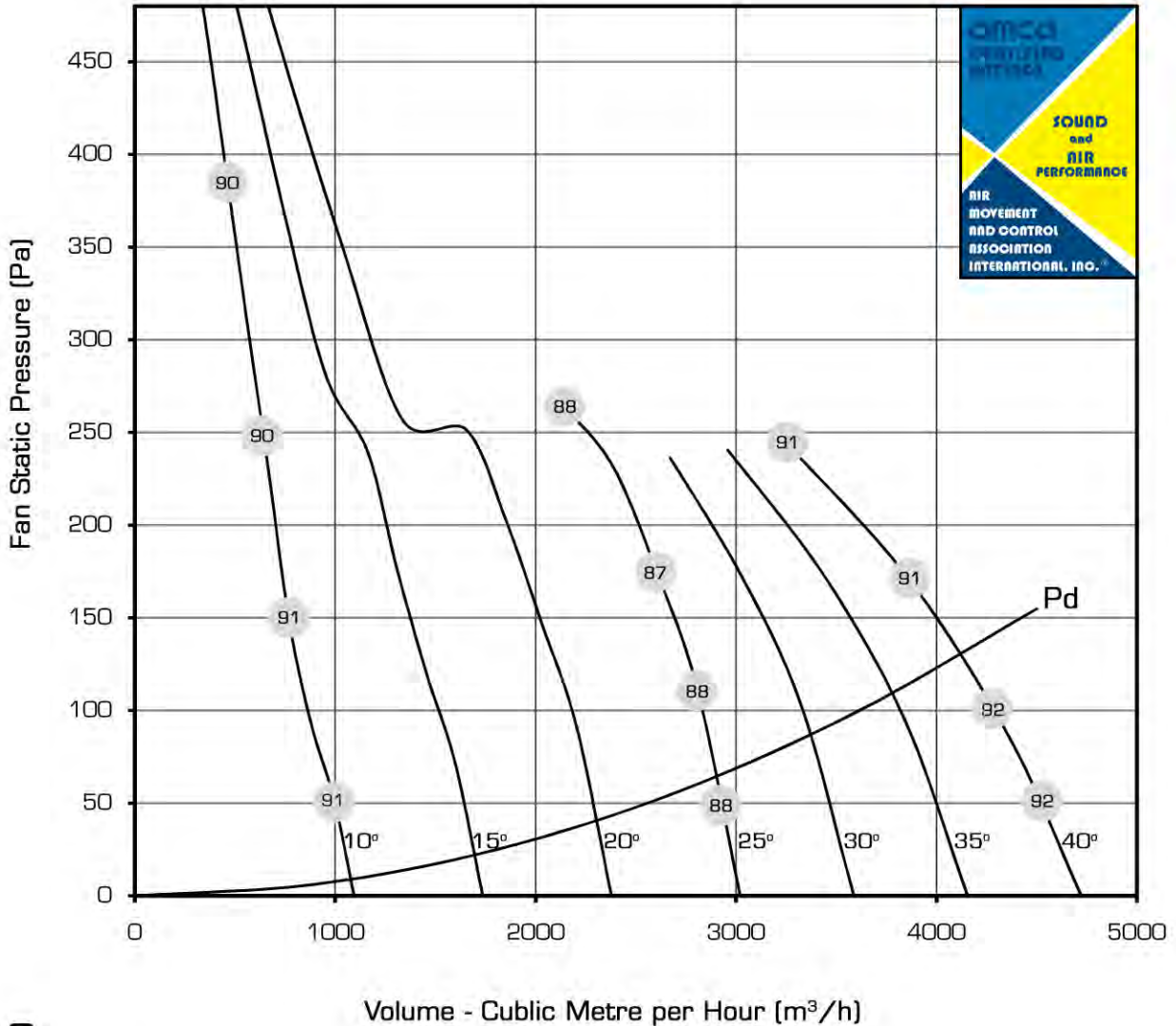

Pitch Angle	10°	15°	20°	25°	30°	35°	40°
Peak kW	0.272	0.411	0.549	0.688	0.848	1.008	1.168

AND 315/10/150 -
315 mm Diameter 1440 Rpm 50 Hz



Performance certified is for installation type D - Ducted Inlet, Ducted Outlet.
 Performance rating do not include the effects of appurtenances (accessories).
 Values shown are for inlet LW_i A sound power levels for installation type D : ducted inlet, ducted outlet.
 Ratings include the effects of duct end correction.
 The A-weighted sound ratings shown have been calculated per AMCA International Standard 301.
 The AMCA Certified Ratings Seal applies to air and sound performance ratings only.

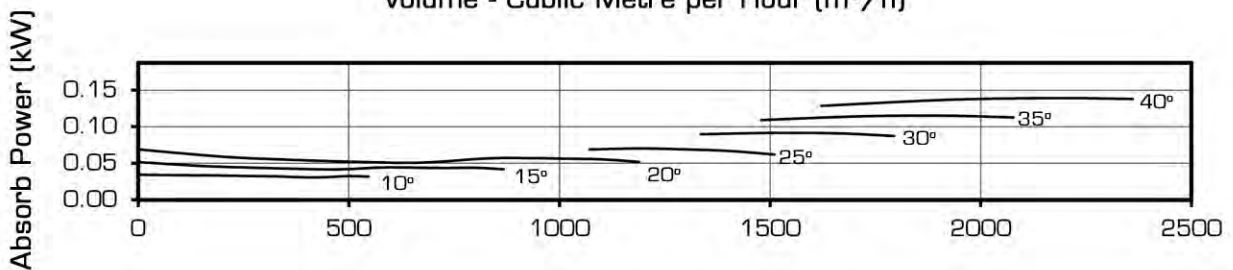
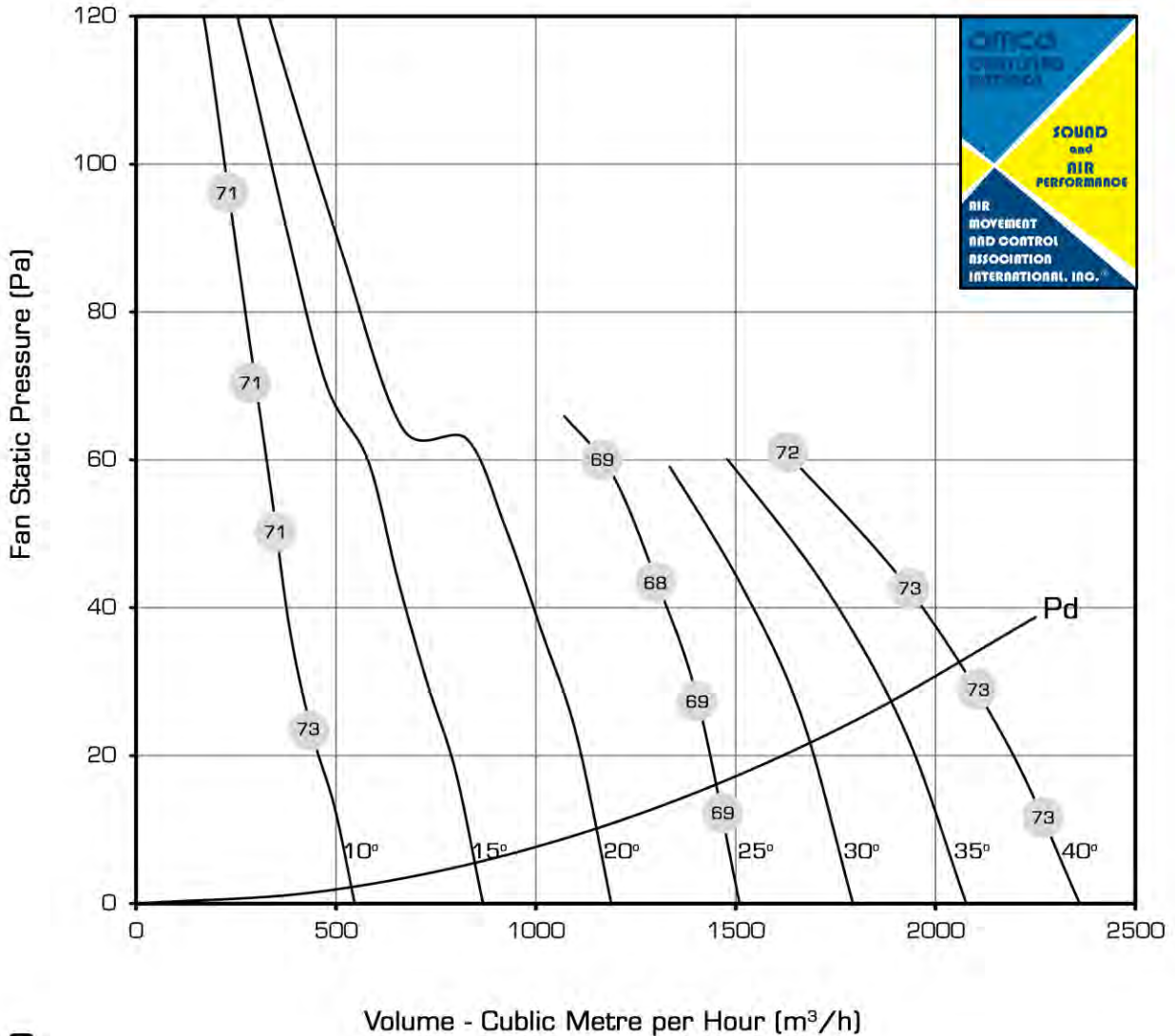

Pitch Angle	10°	15°	20°	25°	30°	35°	40°
Peak kW	0.034	0.051	0.069	0.086	0.106	0.113	0.146

AND 315/10/150 -
315 mm Diameter 960 Rpm 50 Hz

Performance certified is for installation type D - Ducted Inlet, Ducted Outlet.
 Performance rating do not include the effects of appurtenances (accessories).
 Values shown are for inlet LW_i A sound power levels for installation type D : ducted inlet, ducted outlet.
 Ratings include the effects of duct end correction.
 The A-weighted sound ratings shown have been calculated per AMCA International Standard 301.
 The AMCA Certified Ratings Seal applies to air and sound performance ratings only.

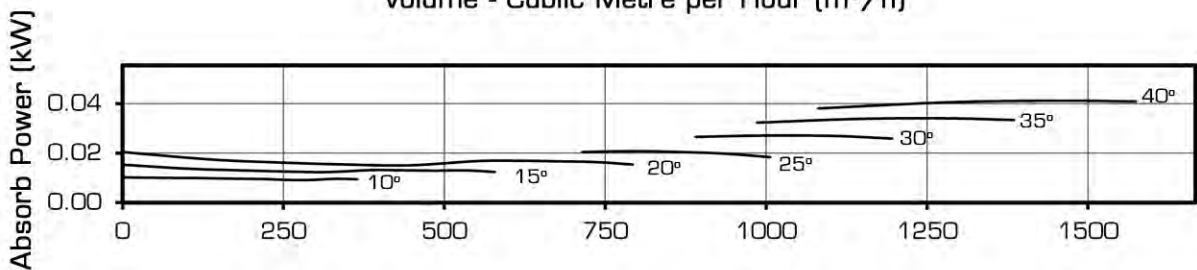
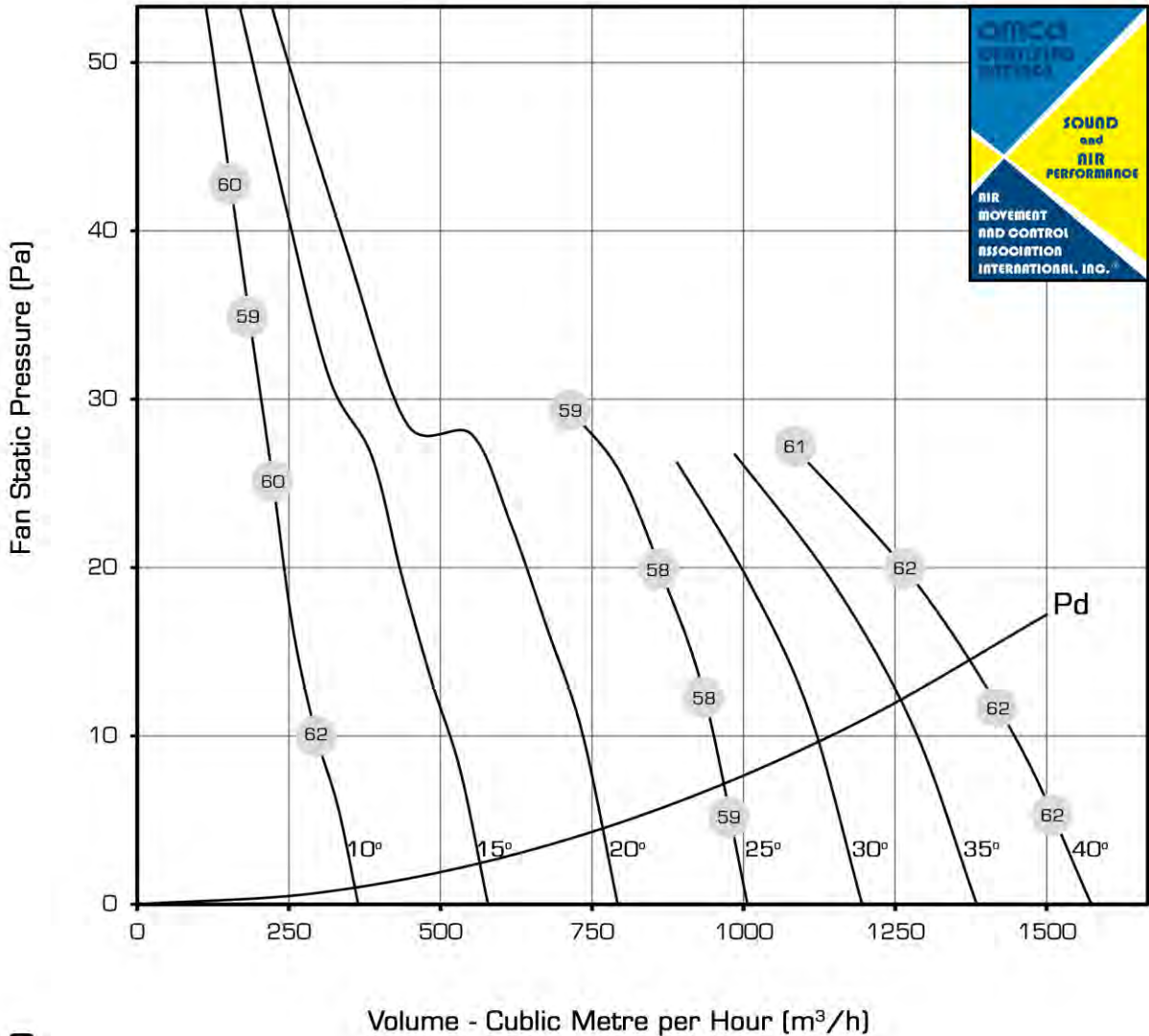

Pitch Angle	10°	15°	20°	25°	30°	35°	40°
Peak kW	0.010	0.015	0.020	0.025	0.031	0.037	0.043

AND 315/10/150 -
315 mm Diameter 720 Rpm 50 Hz



Performance certified is for installation type D - Ducted Inlet, Ducted Outlet.
 Performance rating do not include the effects of appurtenances (accessories).
 Values shown are for inlet LW_i A sound power levels for installation type D : ducted inlet, ducted outlet.
 Ratings include the effects of duct end correction.
 The A-weighted sound ratings shown have been calculated per AMCA International Standard 301.
 The AMCA Certified Ratings Seal applies to air and sound performance ratings only.

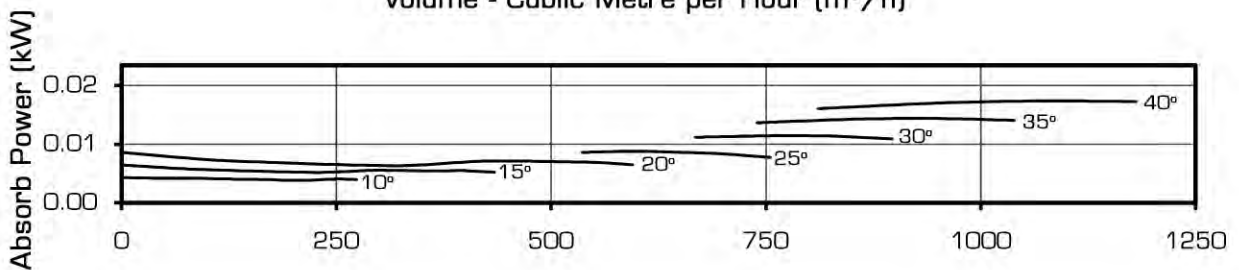
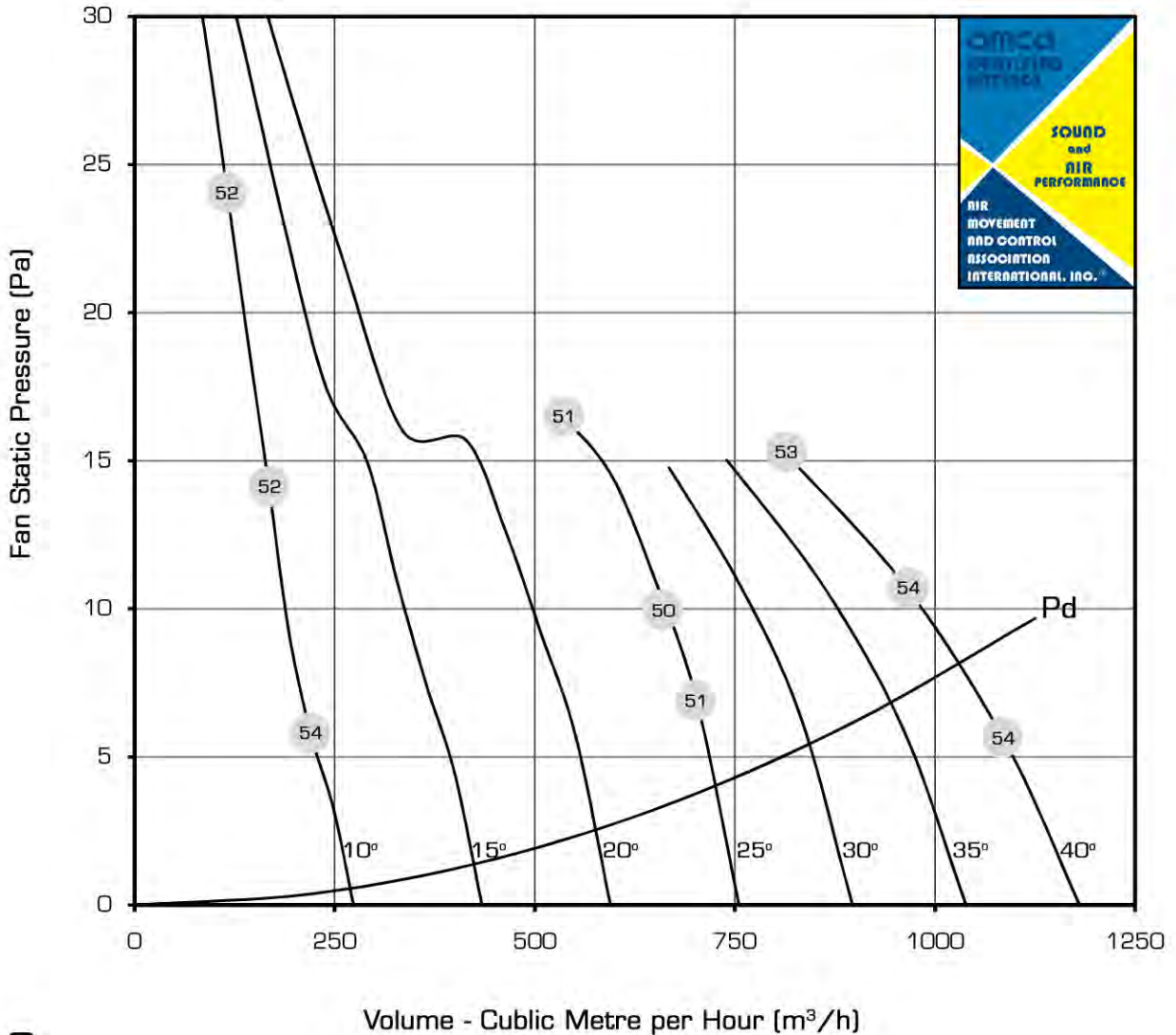

Pitch Angle	10°	15°	20°	25°	30°	35°	40°
Peak kW	0.004	0.006	0.009	0.011	0.013	0.016	0.018

AND 400/10/150 -
 400 mm Diameter 2880 Rpm 50 Hz

Performance certified is for installation type D - Ducted Inlet, Ducted Outlet.
 Performance rating do not include the effects of appurtenances (accessories).
 Values shown are for inlet LW_i A sound power levels for installation type D : ducted inlet, ducted outlet.
 Ratings include the effects of duct end correction.
 The A-weighted sound ratings shown have been calculated per AMCA International Standard 301.
 The AMCA Certified Ratings Seal applies to air and sound performance ratings only.

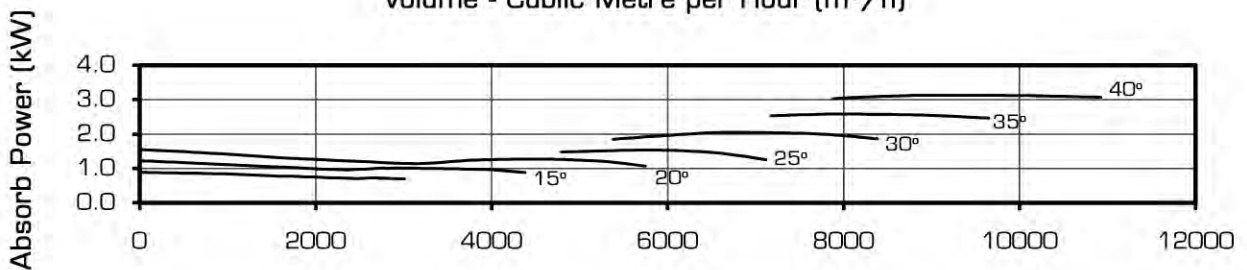
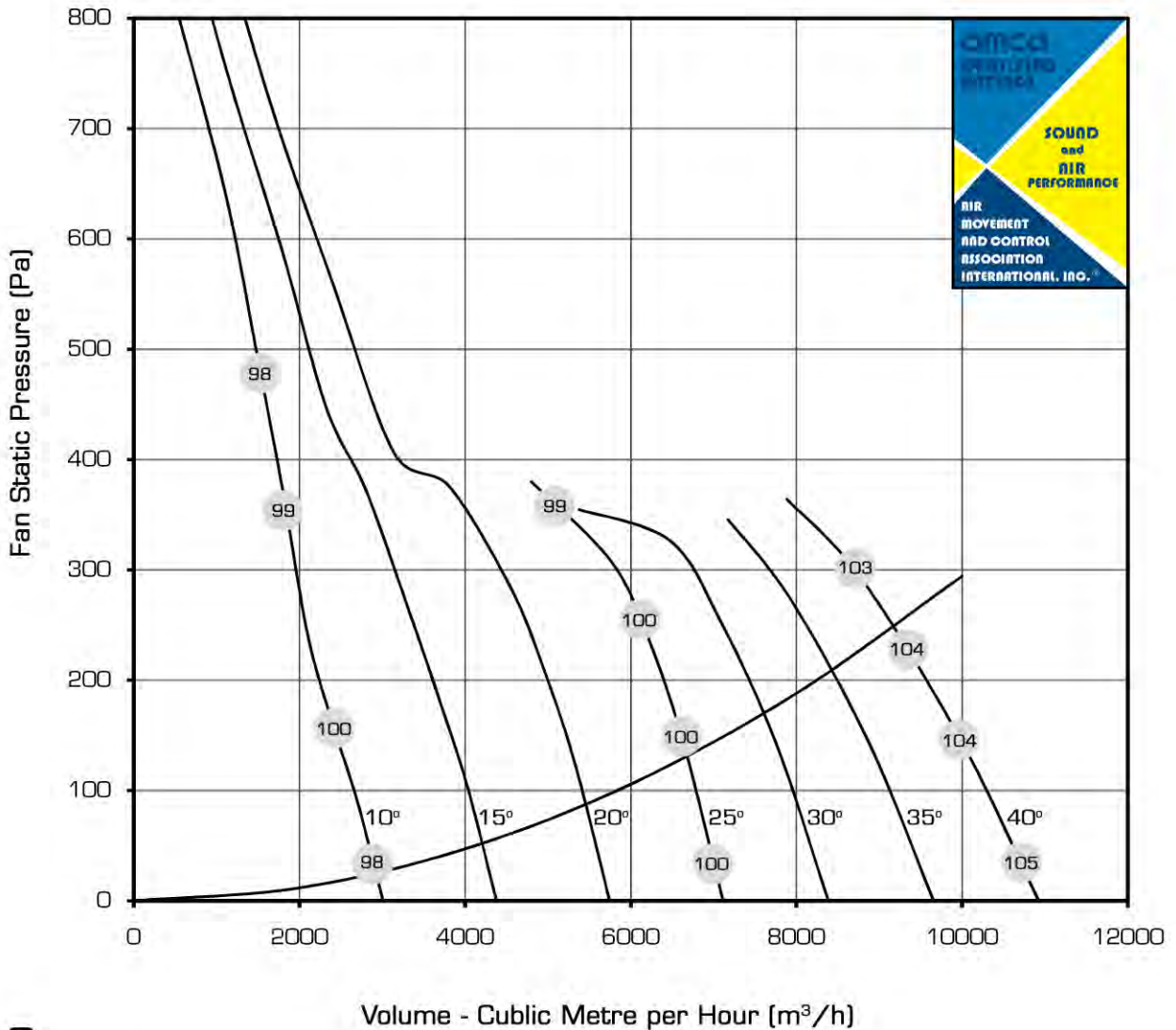

Pitch Angle	10°	15°	20°	25°	30°	35°	40°
Peak kW	0.896	1.224	1.552	1.880	2.369	2.856	3.344

AND 400/10/150 -
 400 mm Diameter 1440 Rpm 50 Hz

Performance certified is for installation type D - Ducted Inlet, Ducted Outlet.
 Performance rating do not include the effects of appurtenances (accessories).
 Values shown are for inlet LW_i A sound power levels for installation type D : ducted inlet, ducted outlet.
 Ratings include the effects of duct end correction.
 The A-weighted sound ratings shown have been calculated per AMCA International Standard 301.
 The AMCA Certified Ratings Seal applies to air and sound performance ratings only.

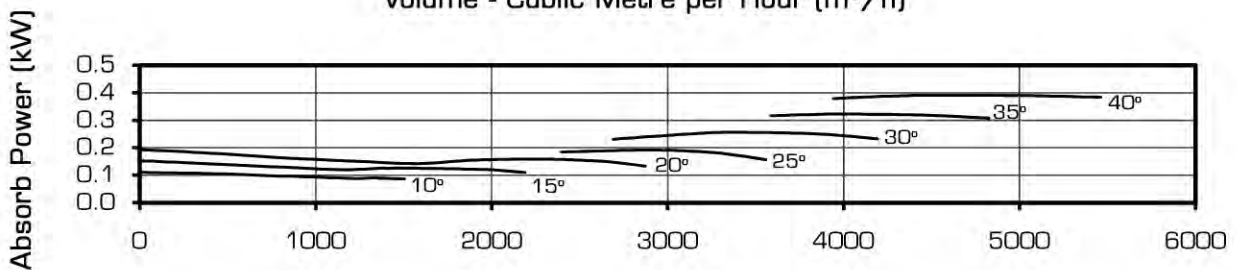
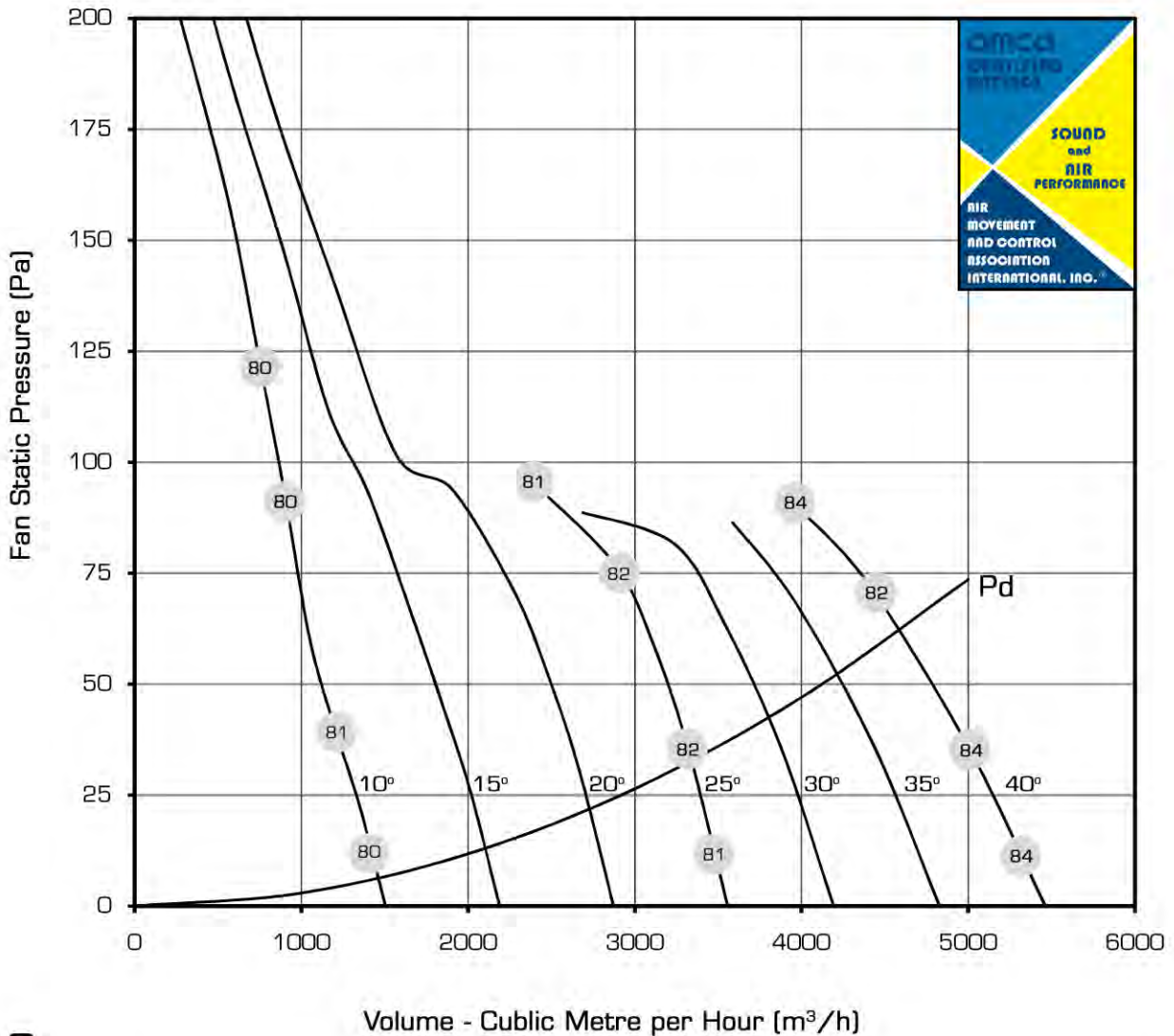

Pitch Angle	10°	15°	20°	25°	30°	35°	40°
Peak kW	0.112	0.153	0.194	0.235	0.296	0.357	0.418

AND 400/10/150 -
 400 mm Diameter 960 Rpm 50 Hz

Performance certified is for installation type D - Ducted Inlet, Ducted Outlet.
 Performance rating do not include the effects of appurtenances (accessories).
 Values shown are for inlet LW_i A sound power levels for installation type D : ducted inlet, ducted outlet.
 Ratings include the effects of duct end correction.
 The A-weighted sound ratings shown have been calculated per AMCA International Standard 301.
 The AMCA Certified Ratings Seal applies to air and sound performance ratings only.

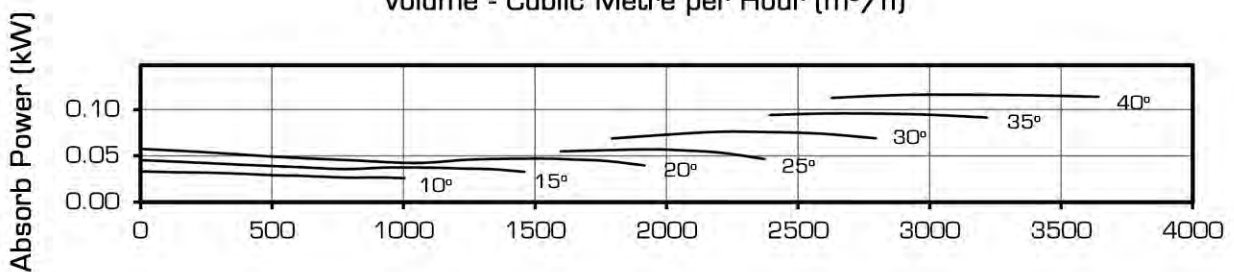
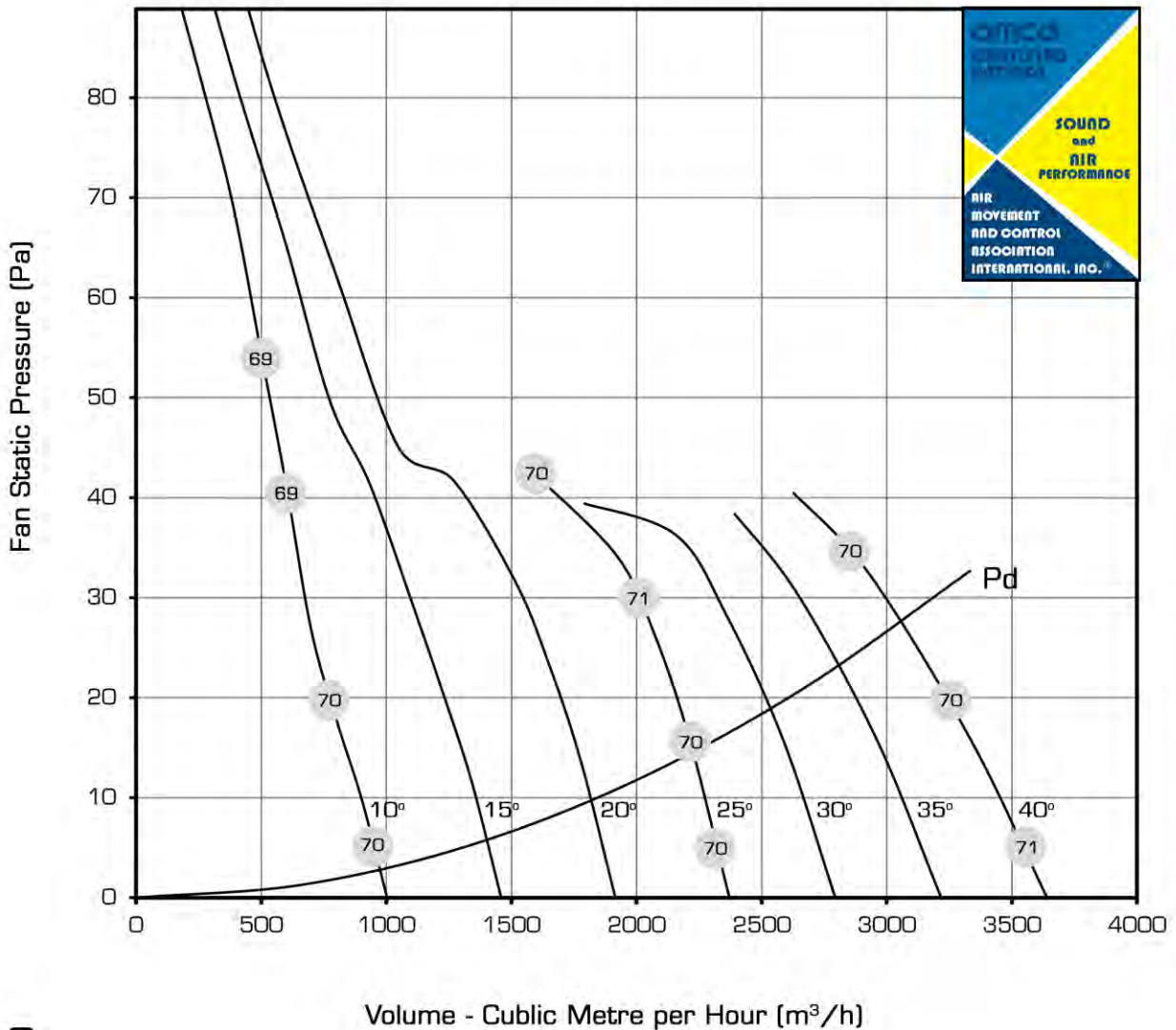

Pitch Angle	10°	15°	20°	25°	30°	35°	40°
Peak kW	0.033	0.045	0.057	0.070	0.088	0.106	0.124

AND 400/10/150 -
400 mm Diameter 720 Rpm 50 Hz

Performance certified is for installation type D - Ducted Inlet, Ducted Outlet.
 Performance rating do not include the effects of appurtenances (accessories).
 Values shown are for inlet LW_i A sound power levels for installation type D : ducted inlet, ducted outlet.
 Ratings include the effects of duct end correction.
 The A-weighted sound ratings shown have been calculated per AMCA International Standard 301.
 The AMCA Certified Ratings Seal applies to air and sound performance ratings only.

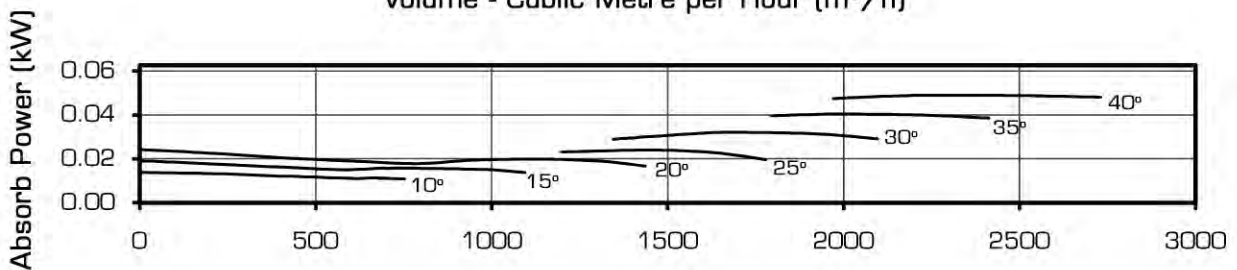
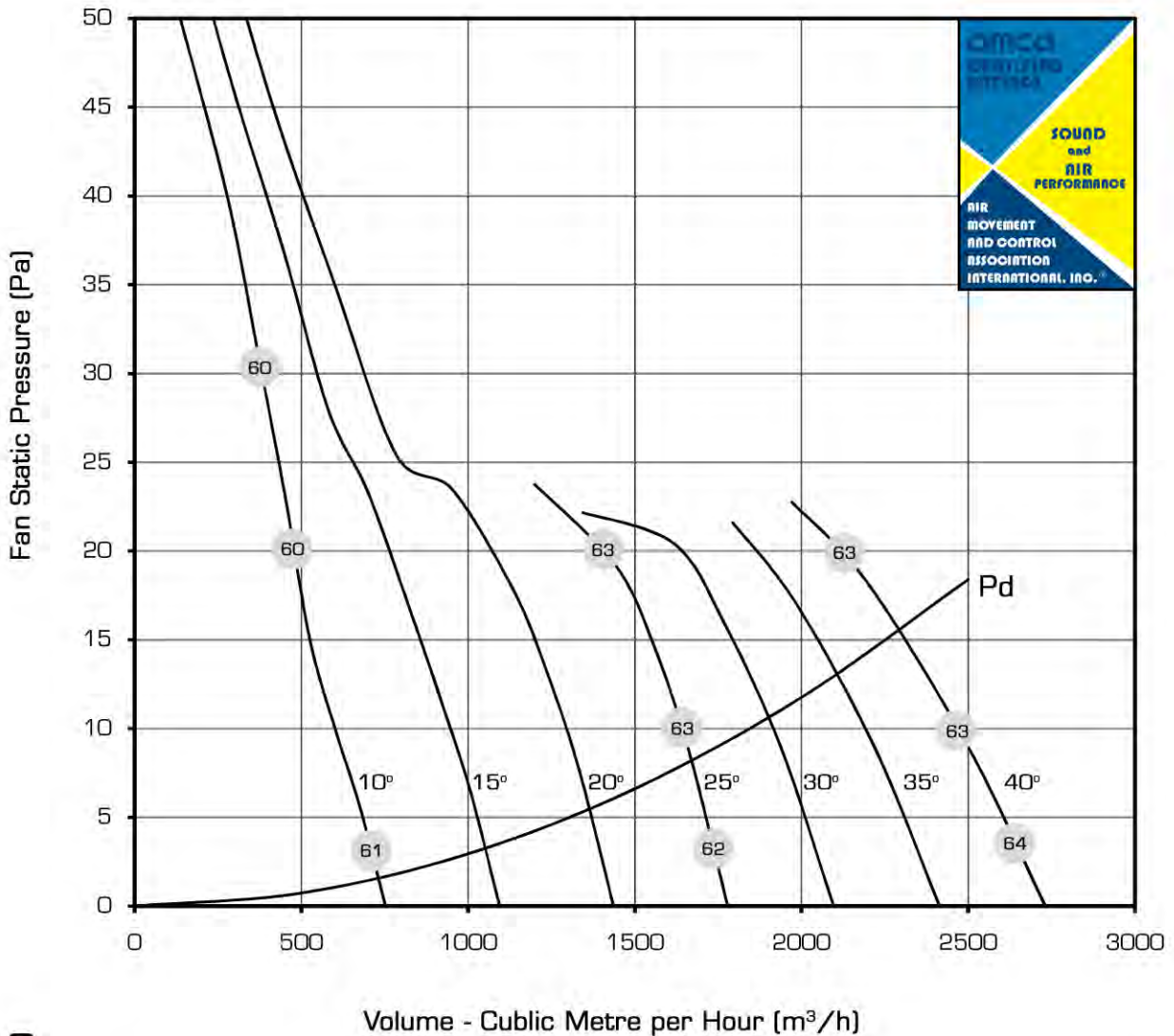

Pitch Angle	10°	15°	20°	25°	30°	35°	40°
Peak kW	0.014	0.019	0.024	0.029	0.037	0.045	0.052

AND 500/10/150 -
500 mm Diameter 2880 Rpm 50 Hz

Performance certified is for installation type D - Ducted Inlet, Ducted Outlet.
Performance rating do not include the effects of appurtenances (accessories).
Values shown are for inlet LW_i A sound power levels for installation type D : ducted inlet, ducted outlet.
Ratings include the effects of duct end correction.
The A-weighted sound ratings shown have been calculated per AMCA International Standard 301.

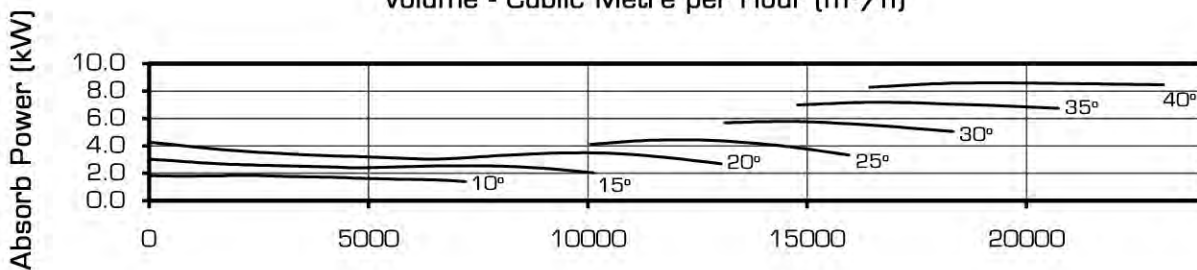
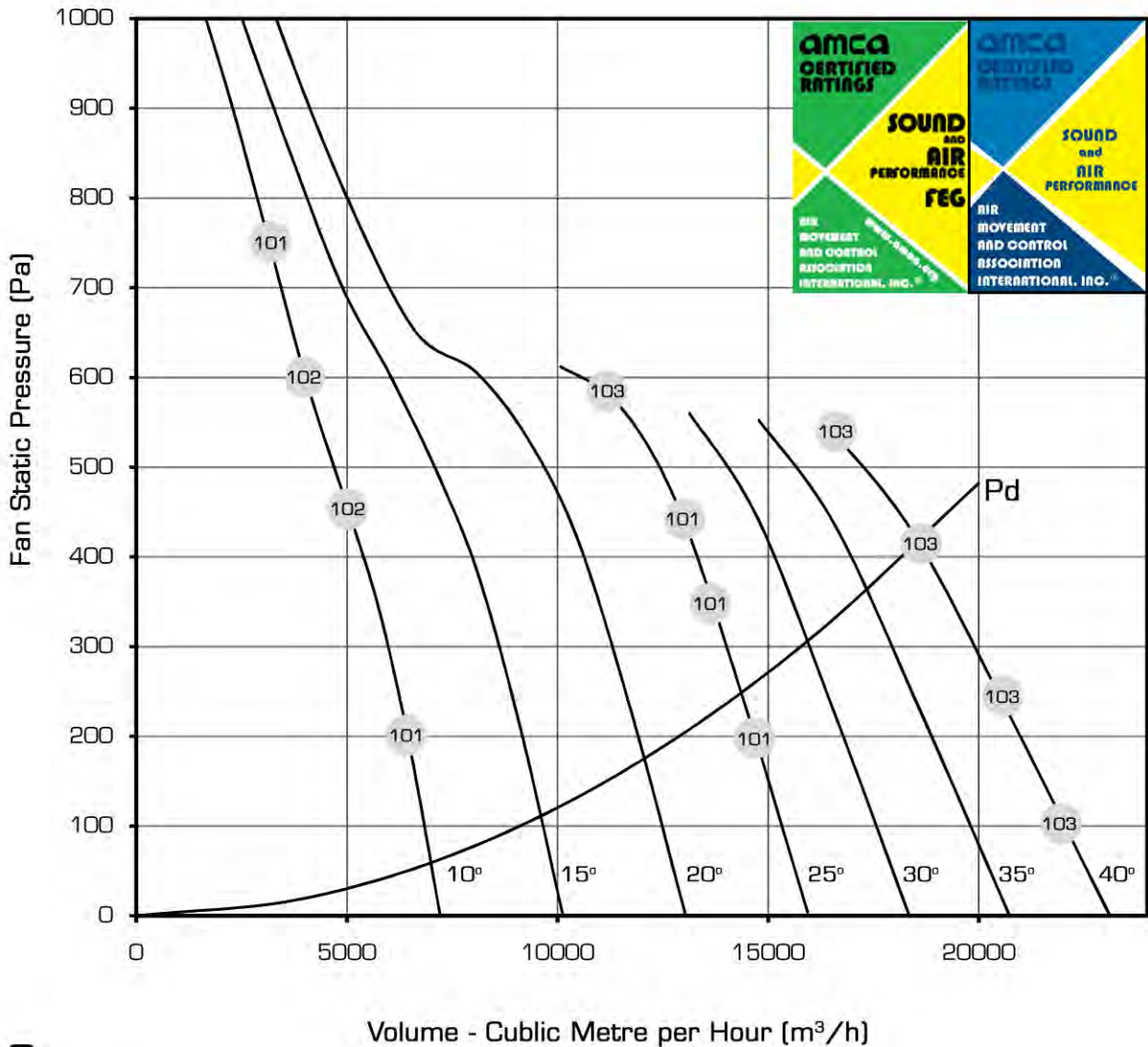

Pitch Angle	10°	15°	20°	25°	30°	35°	40°
Peak kW	1.832	3.045	4.260	5.472	6.501	7.531	8.560

AND 500/10/150 -
500 mm Diameter 1440 Rpm 50 Hz

Performance certified is for installation type D - Ducted Inlet, Ducted Outlet.
Performance rating do not include the effects of appurtenances (accessories).
Values shown are for inlet LW_i A sound power levels for installation type D : ducted inlet, ducted outlet.
Ratings include the effects of duct end correction.
The A-weighted sound ratings shown have been calculated per AMCA International Standard 301.

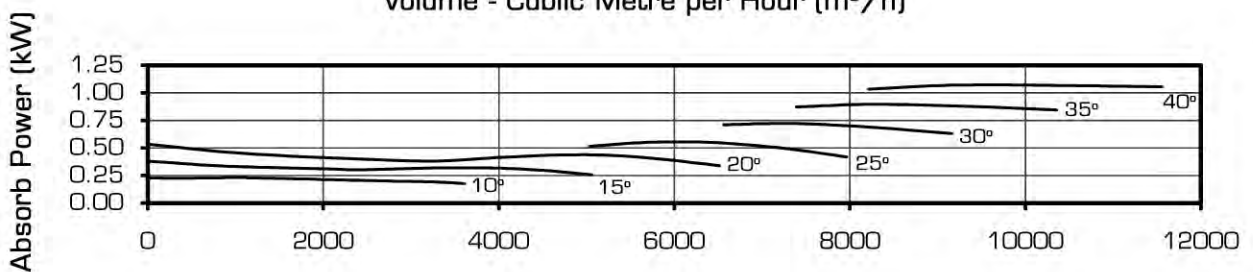
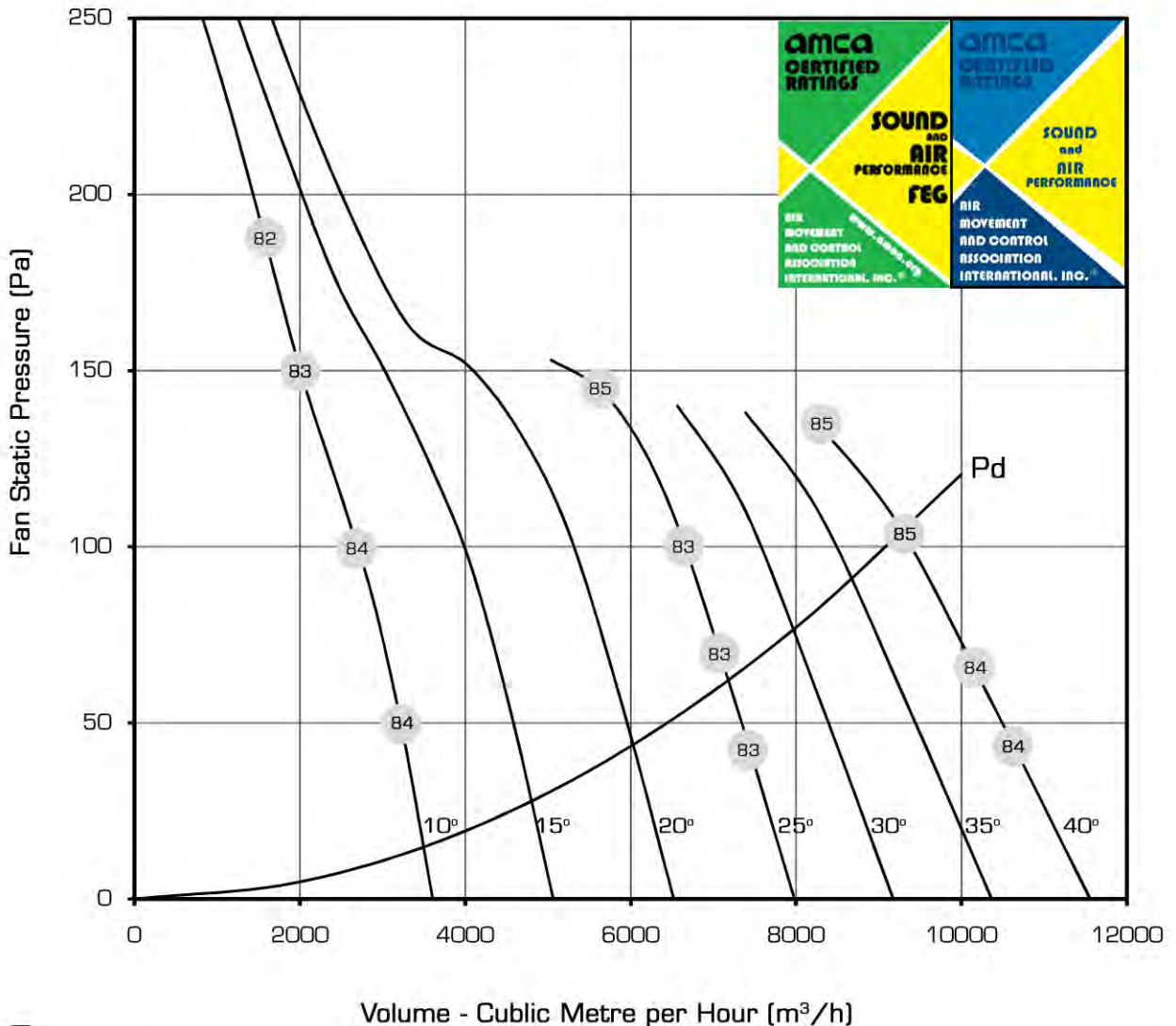

Pitch Angle	10°	15°	20°	25°	30°	35°	40°
Peak kW	0.229	0.381	0.532	0.684	0.813	0.941	1.070

AND 500/10/150 -
500 mm Diameter 960 Rpm 50 Hz

Performance certified is for installation type D - Ducted Inlet, Ducted Outlet.
Performance rating do not include the effects of appurtenances (accessories).
Values shown are for inlet LW_i A sound power levels for installation type D : ducted inlet, ducted outlet.
Ratings include the effects of duct end correction.
The A-weighted sound ratings shown have been calculated per AMCA International Standard 301.

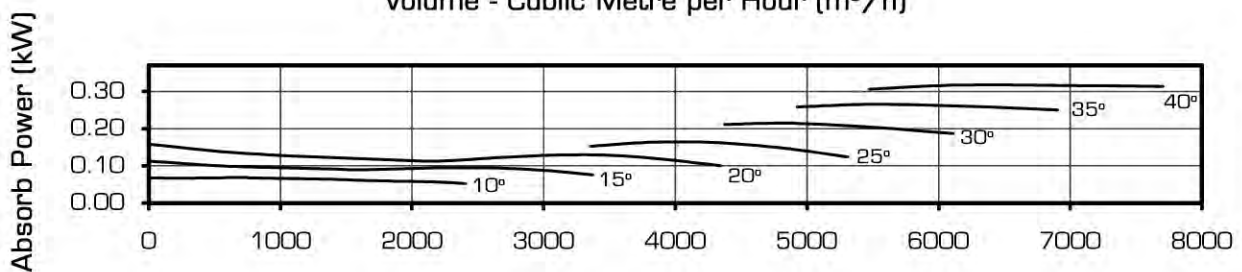
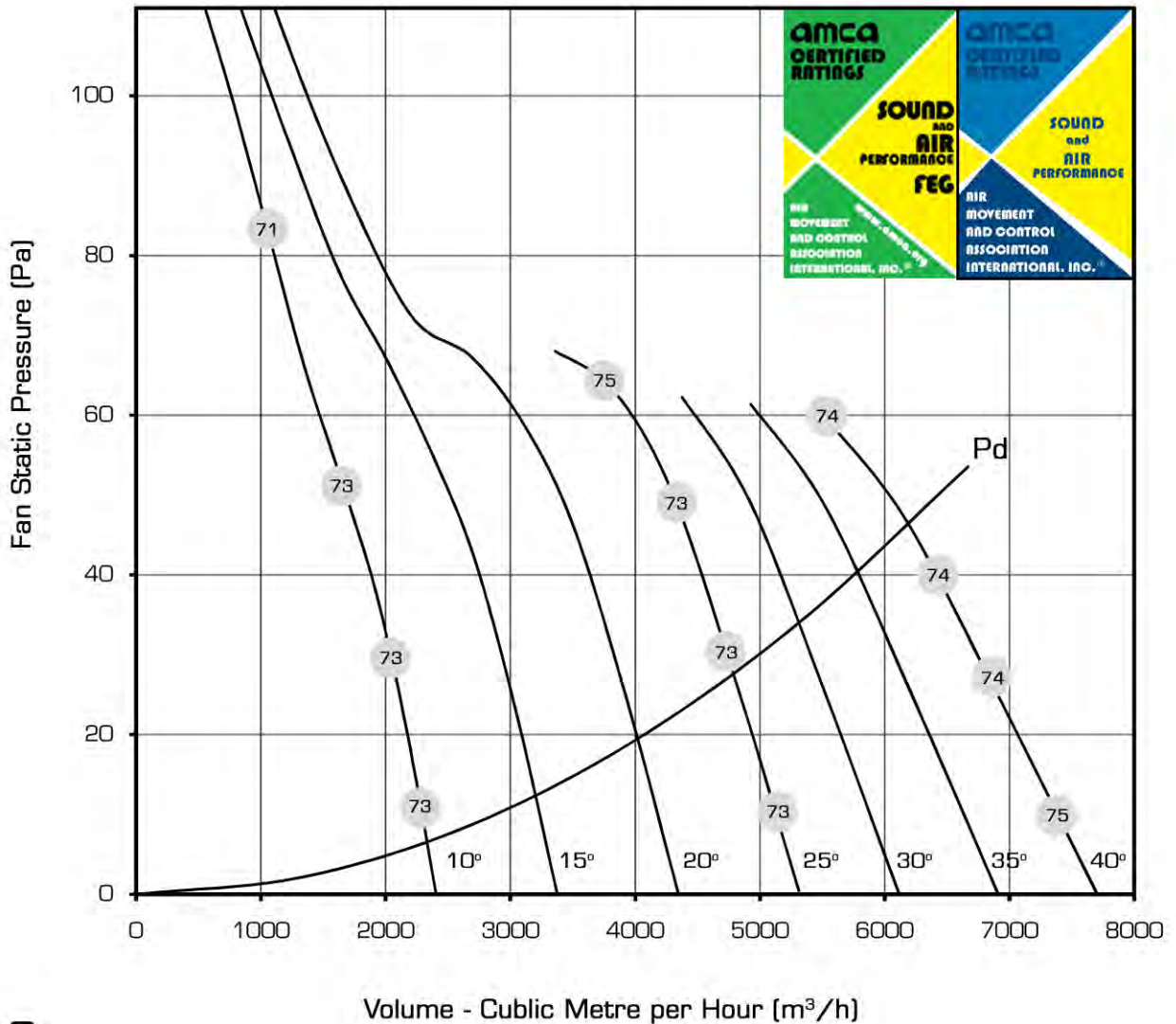

Pitch Angle	10°	15°	20°	25°	30°	35°	40°
Peak kW	0.068	0.113	0.158	0.203	0.241	0.279	0.317

AND 500/10/150 -
500 mm Diameter 720 Rpm 50 Hz

Performance certified is for installation type D - Ducted Inlet, Ducted Outlet.
Performance rating do not include the effects of appurtenances (accessories).
Values shown are for inlet LW_i A sound power levels for installation type D : ducted inlet, ducted outlet.
Ratings include the effects of duct end correction.
The A-weighted sound ratings shown have been calculated per AMCA International Standard 301.

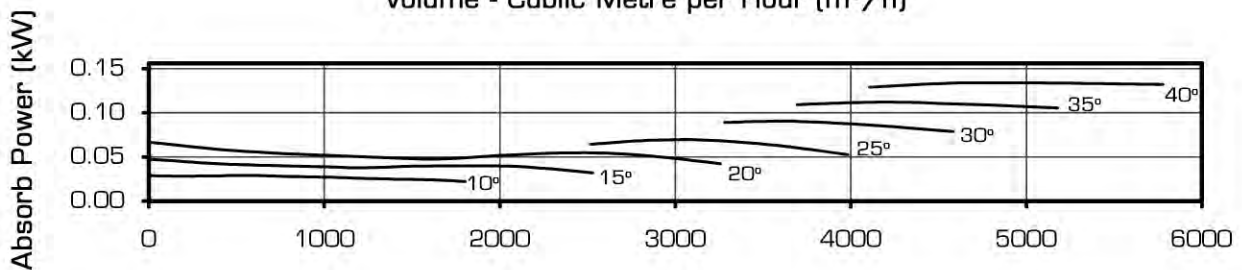
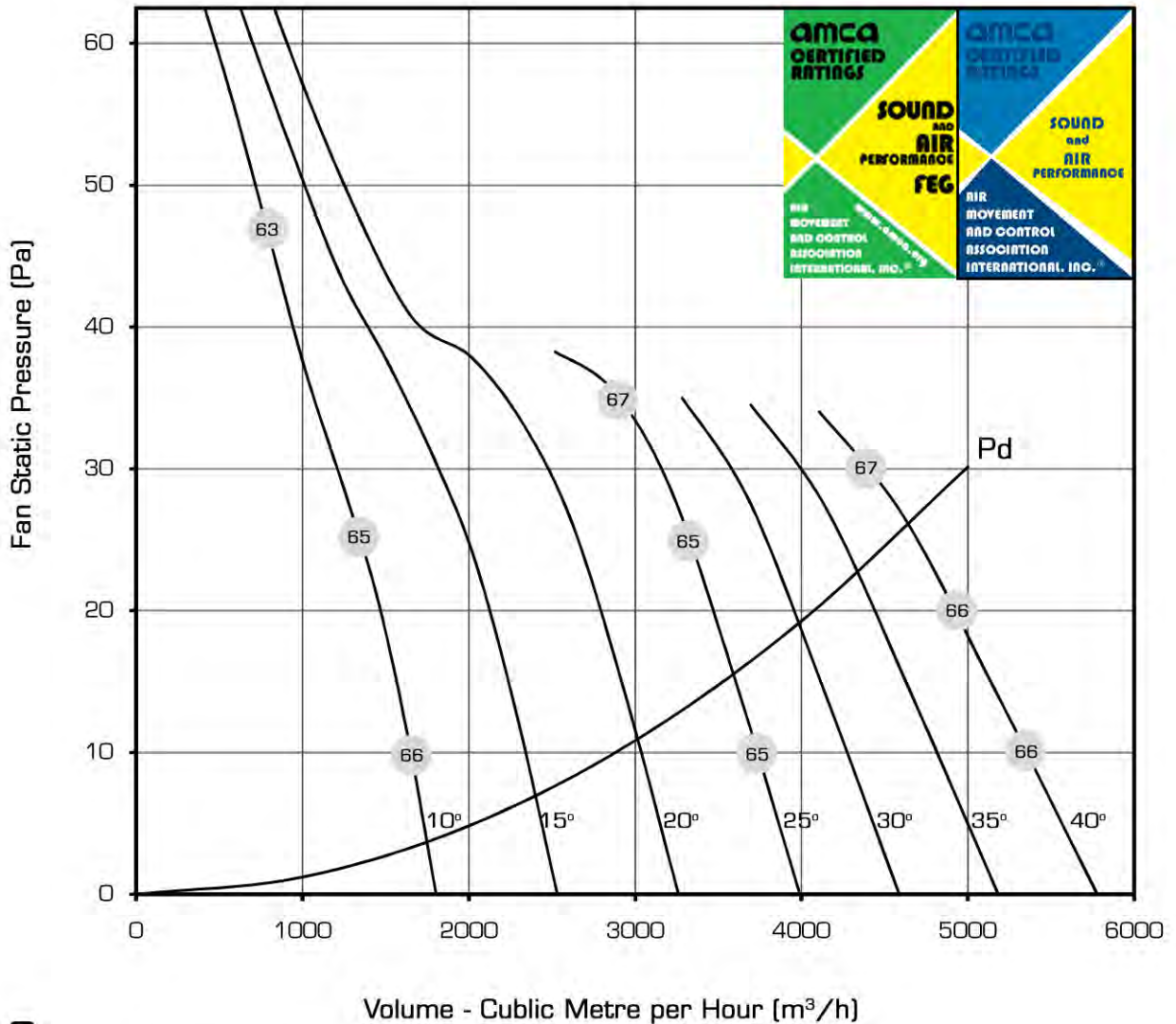

Pitch Angle	10°	15°	20°	25°	30°	35°	40°
Peak kW	0.029	0.048	0.067	0.086	0.102	0.118	0.134

AND 560/14/250 -
560 mm Diameter 1440 Rpm 50 Hz

Performance certified is for installation type D - Ducted Inlet, Ducted Outlet.
 Performance rating do not include the effects of appurtenances (accessories).
 Values shown are for inlet LW_i A sound power levels for installation type D : ducted inlet, ducted outlet.
 Ratings include the effects of duct end correction.
 The A-weighted sound ratings shown have been calculated per AMCA International Standard 301.

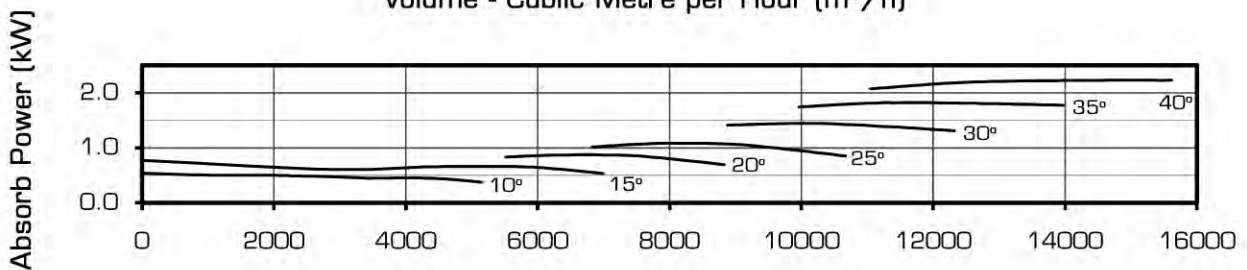
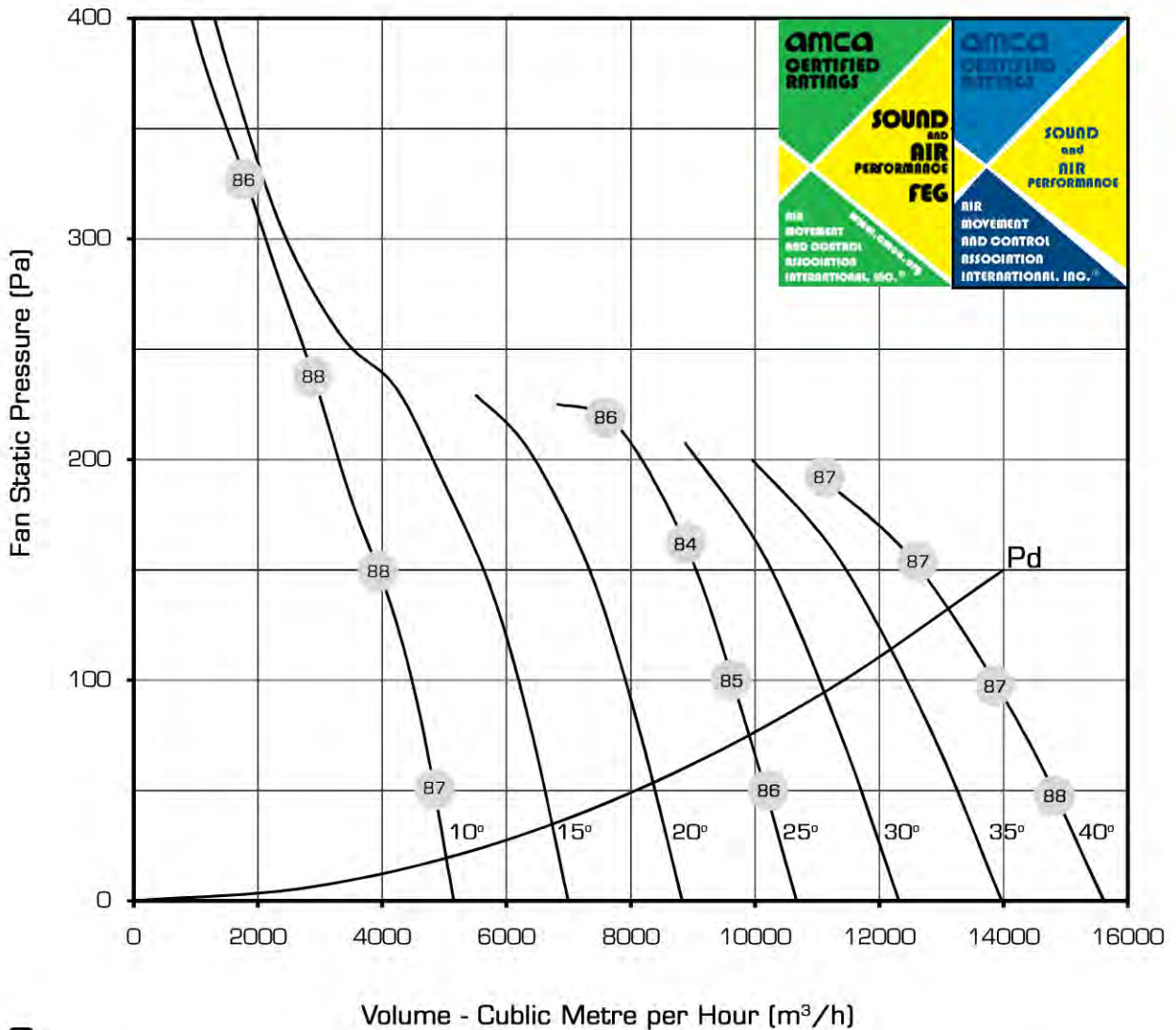

Pitch Angle	10°	15°	20°	25°	30°	35°	40°
Peak kW	0.541	0.772	1.003	1.234	1.512	1.789	2.067

AND 560/14/250 -
560 mm Diameter 960 Rpm 50 Hz

Performance certified is for installation type D - Ducted Inlet, Ducted Outlet.
Performance rating do not include the effects of appurtenances (accessories).
Values shown are for inlet LW_i A sound power levels for installation type D : ducted inlet, ducted outlet.
Ratings include the effects of duct end correction.
The A-weighted sound ratings shown have been calculated per AMCA International Standard 301.

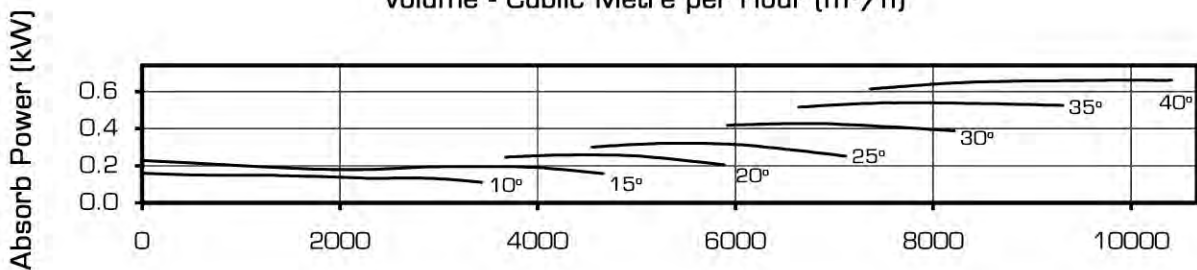
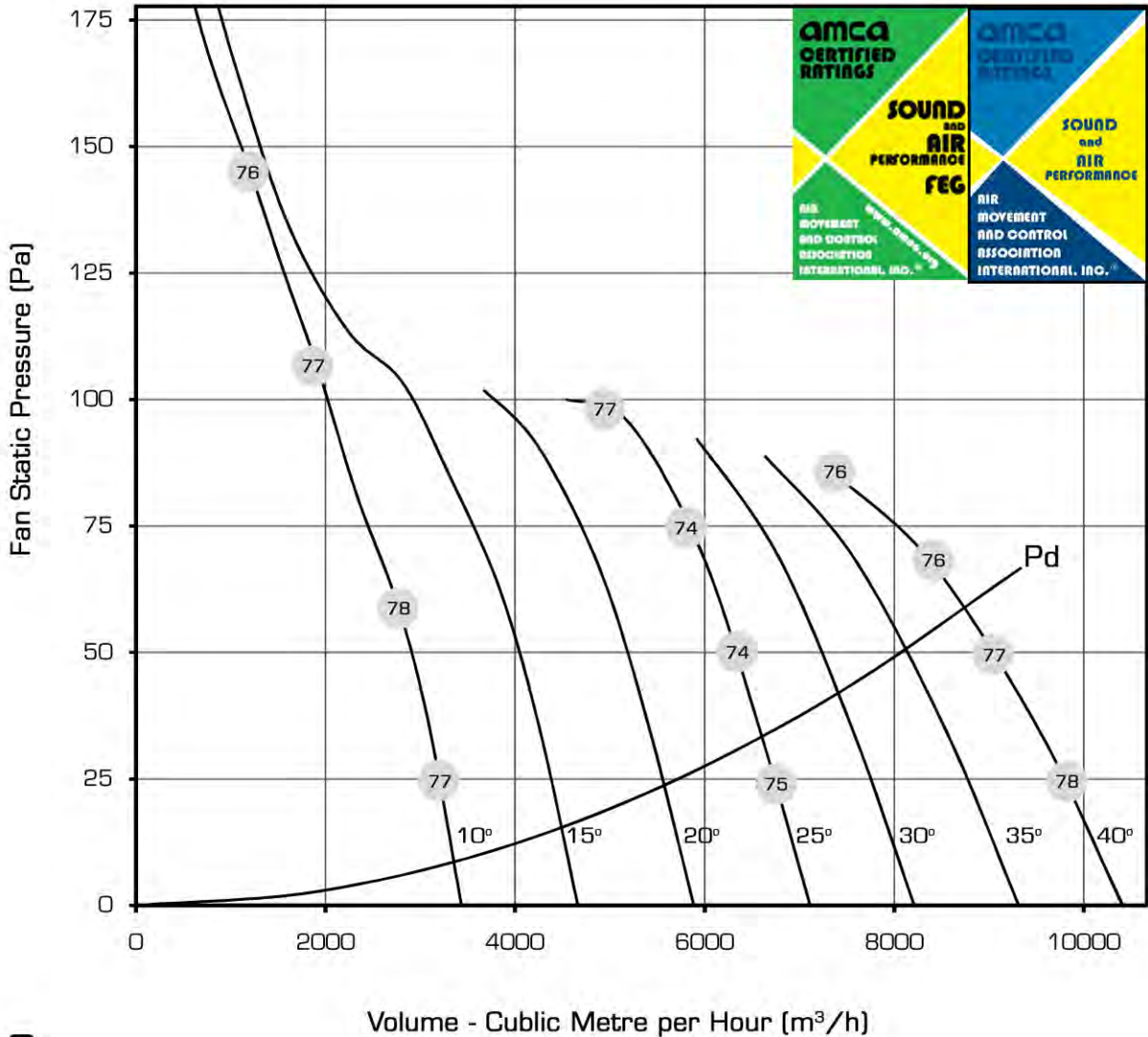

Pitch Angle	10°	15°	20°	25°	30°	35°	40°
Peak kW	0.160	0.229	0.297	0.366	0.464	0.563	0.662

AND 560/14/250 -
560 mm Diameter 720 Rpm 50 Hz

Performance certified is for installation type D - Ducted Inlet, Ducted Outlet.
 Performance rating do not include the effects of appurtenances (accessories).
 Values shown are for inlet LW_i A sound power levels for installation type D : ducted inlet, ducted outlet.
 Ratings include the effects of duct end correction.
 The A-weighted sound ratings shown have been calculated per AMCA International Standard 301.

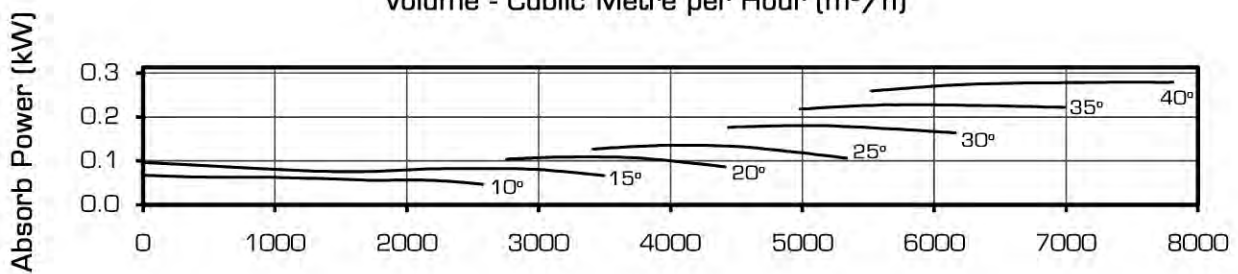
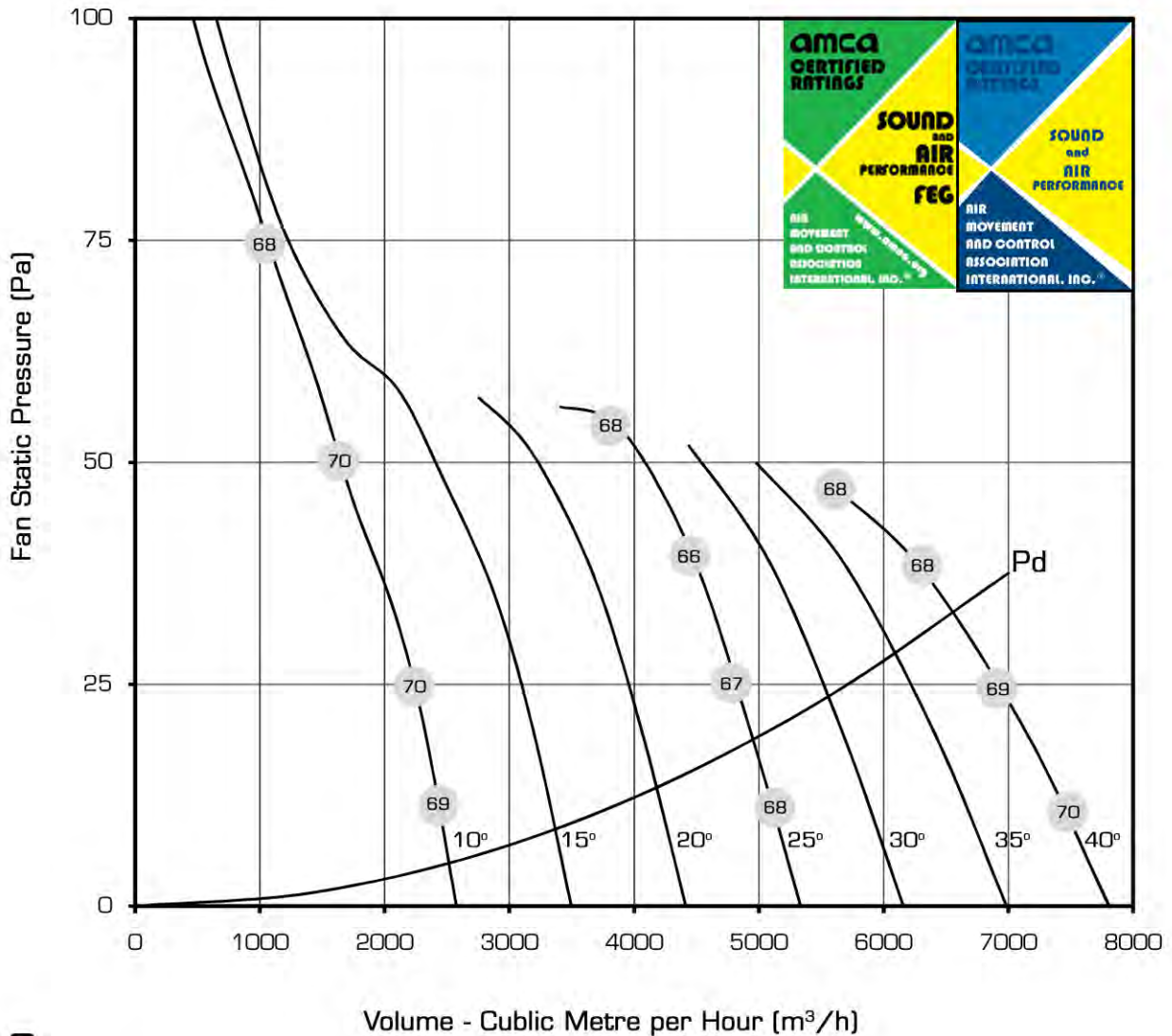

Pitch Angle	10°	15°	20°	25°	30°	35°	40°
Peak kW	0.068	0.097	0.125	0.154	0.196	0.238	0.279

AND 630/14/250 -
630 mm Diameter 1440 Rpm 50 Hz

Performance certified is for installation type D - Ducted Inlet, Ducted Outlet.
Performance rating do not include the effects of appurtenances (accessories).
Values shown are for inlet LW_i A sound power levels for installation type D : ducted inlet, ducted outlet.
Ratings include the effects of duct end correction.
The A-weighted sound ratings shown have been calculated per AMCA International Standard 301.

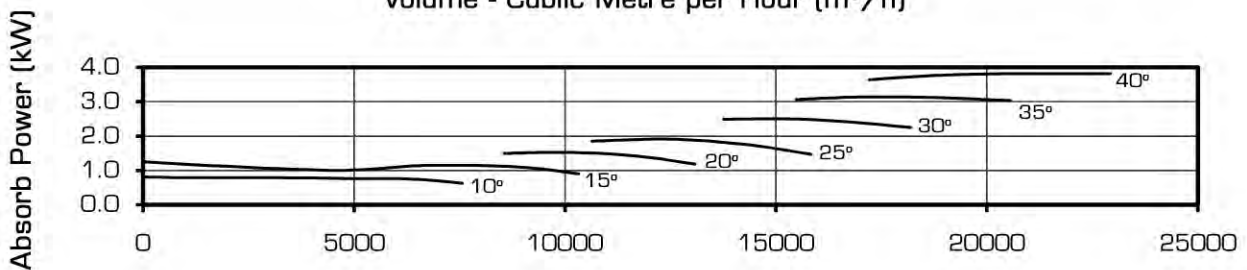
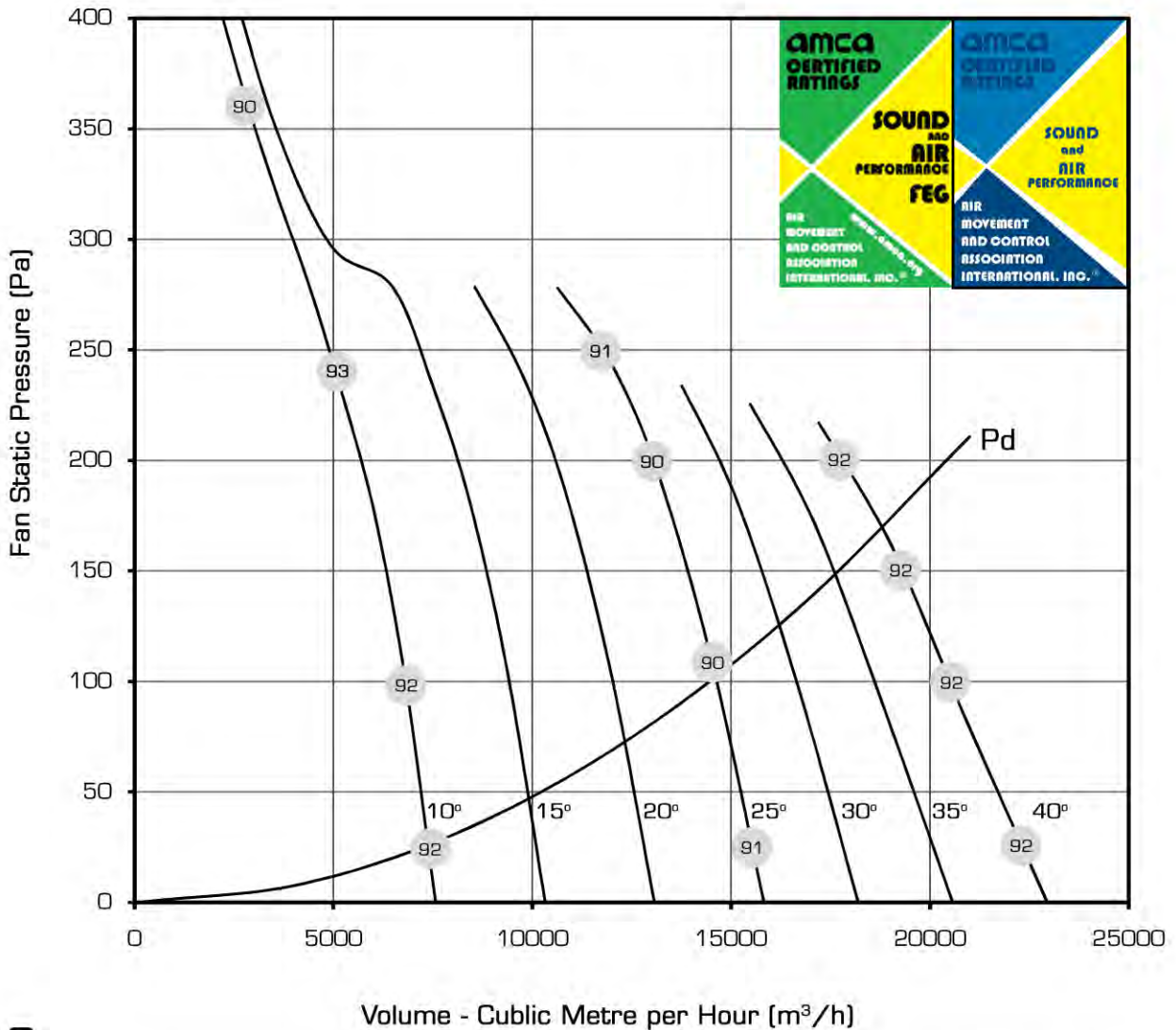

Pitch Angle	10°	15°	20°	25°	30°	35°	40°
Peak kW	0.816	1.254	1.692	2.130	2.695	3.259	3.824

AND 630/14/250 -
630 mm Diameter 960 Rpm 50 Hz

Performance certified is for installation type D - Ducted Inlet, Ducted Outlet.
Performance rating do not include the effects of appurtenances (accessories).
Values shown are for inlet LW_i A sound power levels for installation type D : ducted inlet, ducted outlet.
Ratings include the effects of duct end correction.
The A-weighted sound ratings shown have been calculated per AMCA International Standard 301.

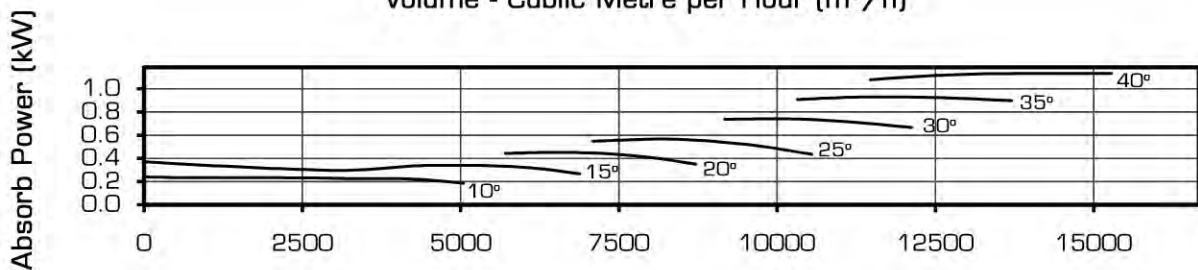
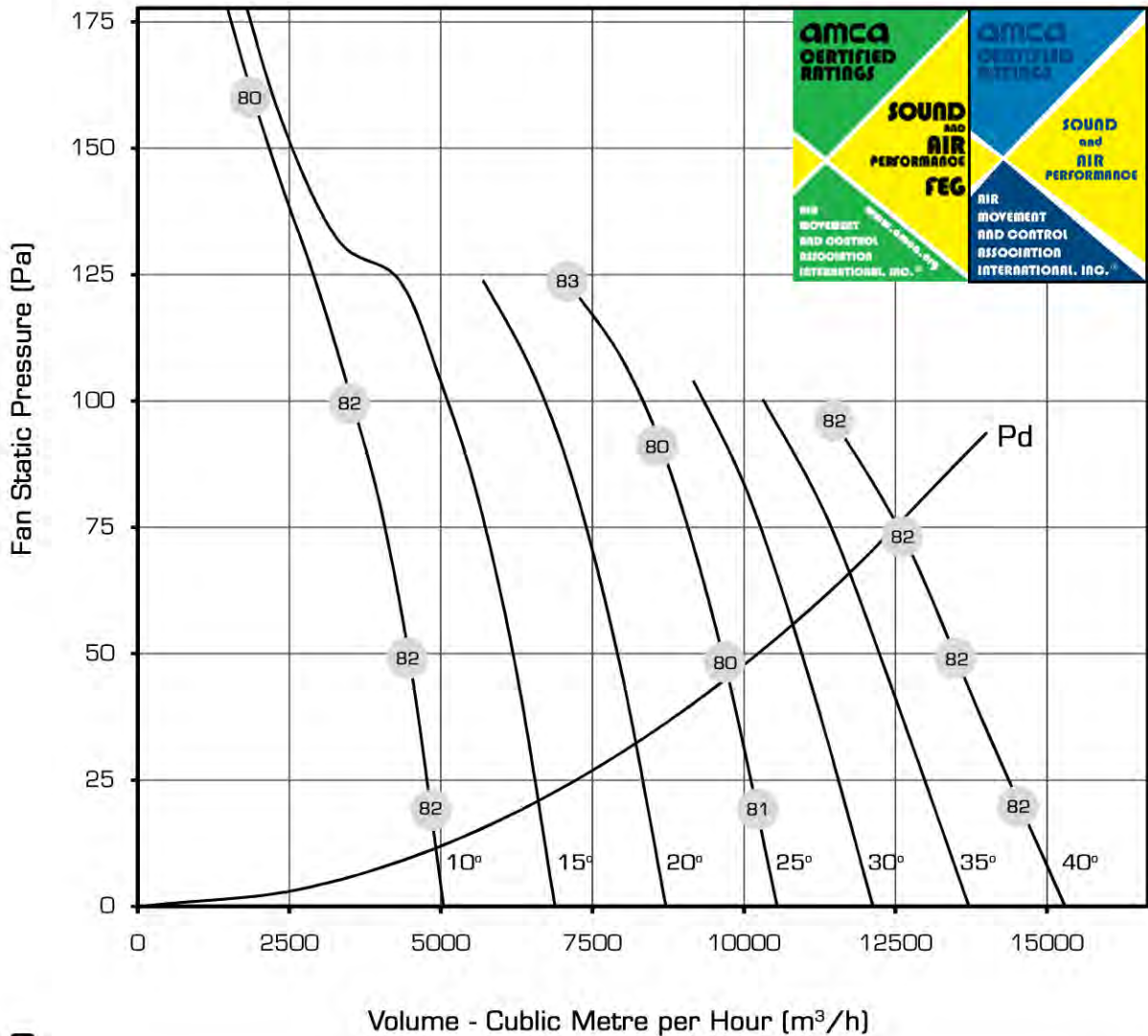

Pitch Angle	10°	15°	20°	25°	30°	35°	40°
Peak kW	0.242	0.372	0.501	0.631	0.798	0.966	1.133

AND 630/14/250 -
630 mm Diameter 720 Rpm 50 Hz

Performance certified is for installation type D - Ducted Inlet, Ducted Outlet.
Performance rating do not include the effects of appurtenances (accessories).
Values shown are for inlet LW_i A sound power levels for installation type D : ducted inlet, ducted outlet.
Ratings include the effects of duct end correction.
The A-weighted sound ratings shown have been calculated per AMCA International Standard 301.

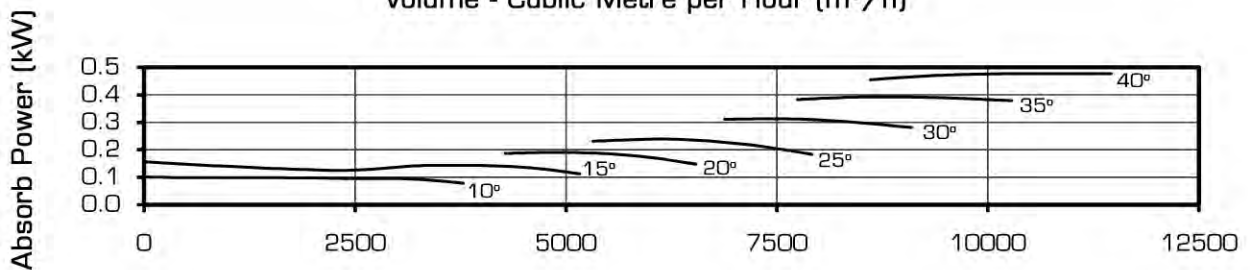
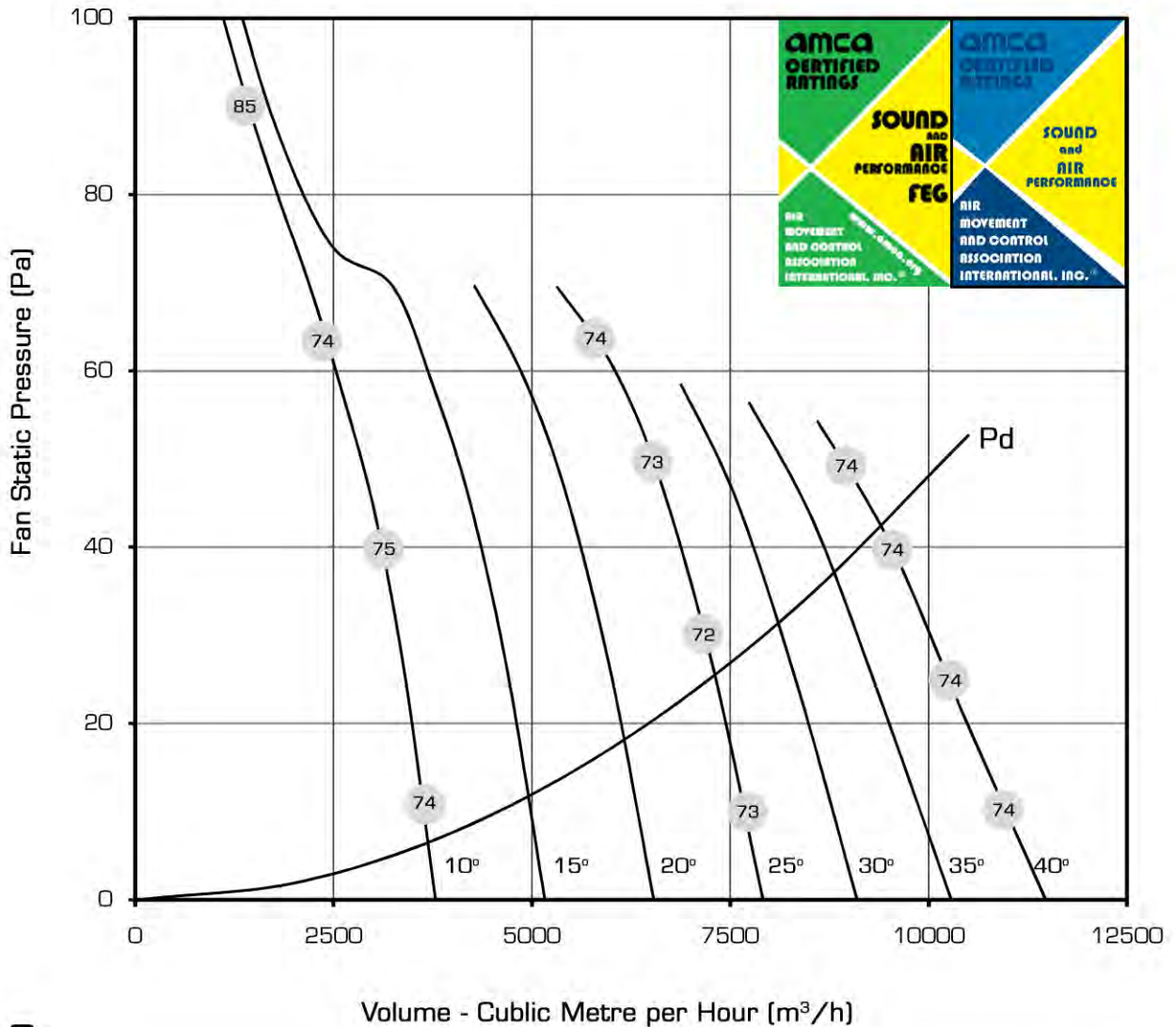

Pitch Angle	10°	15°	20°	25°	30°	35°	40°
Peak kW	0.102	0.157	0.212	0.266	0.337	0.407	0.478

AND 710/14/250 -
710 mm Diameter 1440 Rpm 50 Hz

Performance certified is for installation type D - Ducted Inlet, Ducted Outlet.
Performance rating do not include the effects of appurtenances (accessories).
Values shown are for inlet LW_i A sound power levels for installation type D : ducted inlet, ducted outlet.
Ratings include the effects of duct end correction.
The A-weighted sound ratings shown have been calculated per AMCA International Standard 301.

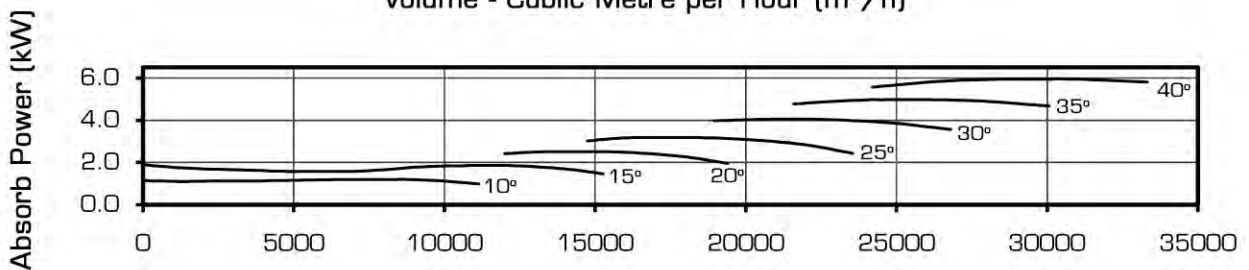
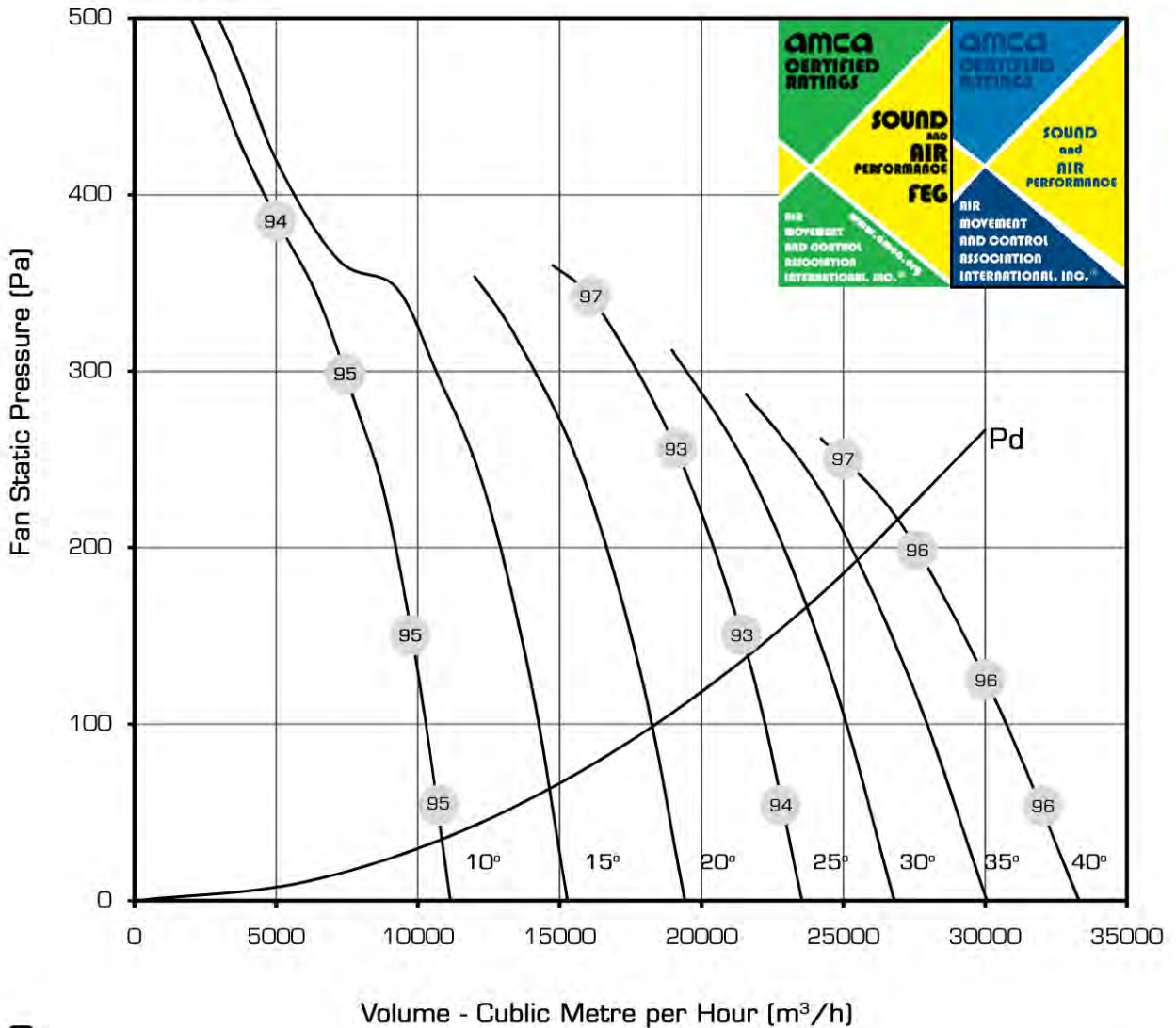

Pitch Angle	10°	15°	20°	25°	30°	35°	40°
Peak kW	1.196	1.924	2.653	3.381	4.240	5.100	5.959

AND 710/14/250 -
710 mm Diameter 960 Rpm 50 Hz

Performance certified is for installation type D - Ducted Inlet, Ducted Outlet.
Performance rating do not include the effects of appurtenances (accessories).
Values shown are for inlet LW_i A sound power levels for installation type D : ducted inlet, ducted outlet.
Ratings include the effects of duct end correction.
The A-weighted sound ratings shown have been calculated per AMCA International Standard 301.

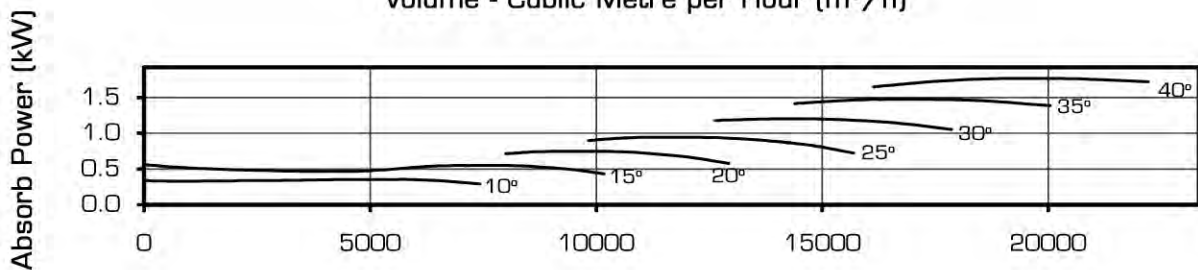
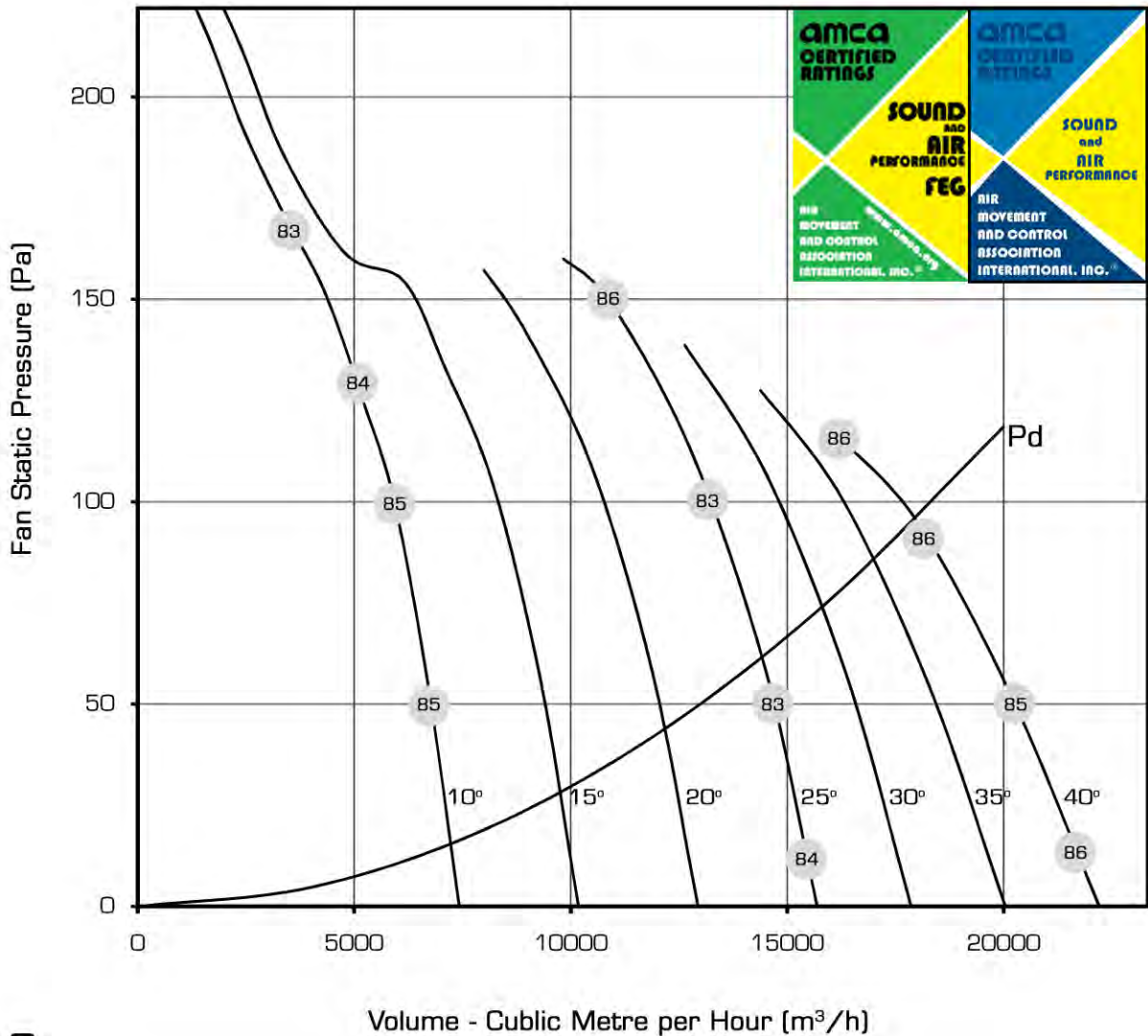

Pitch Angle	10°	15°	20°	25°	30°	35°	40°
Peak kW	0.354	0.570	0.786	1.002	1.256	1.511	1.766

AND 710/14/250 -
710 mm Diameter 720 Rpm 50 Hz

Performance certified is for installation type D - Ducted Inlet, Ducted Outlet.
Performance rating do not include the effects of appurtenances (accessories).
Values shown are for inlet LW_i A sound power levels for installation type D : ducted inlet, ducted outlet.
Ratings include the effects of duct end correction.
The A-weighted sound ratings shown have been calculated per AMCA International Standard 301.

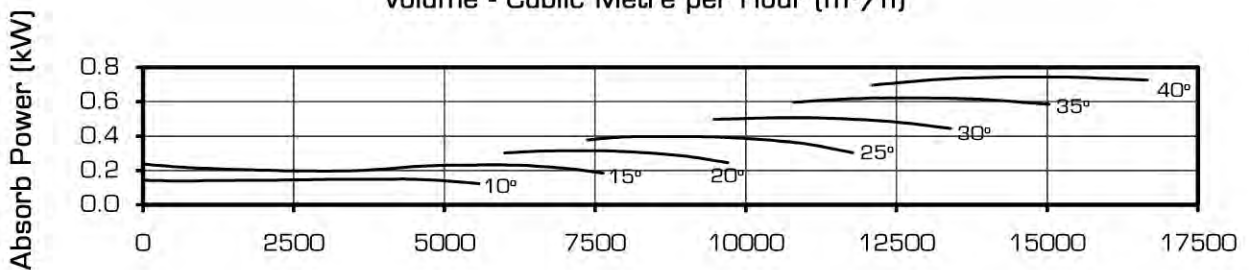
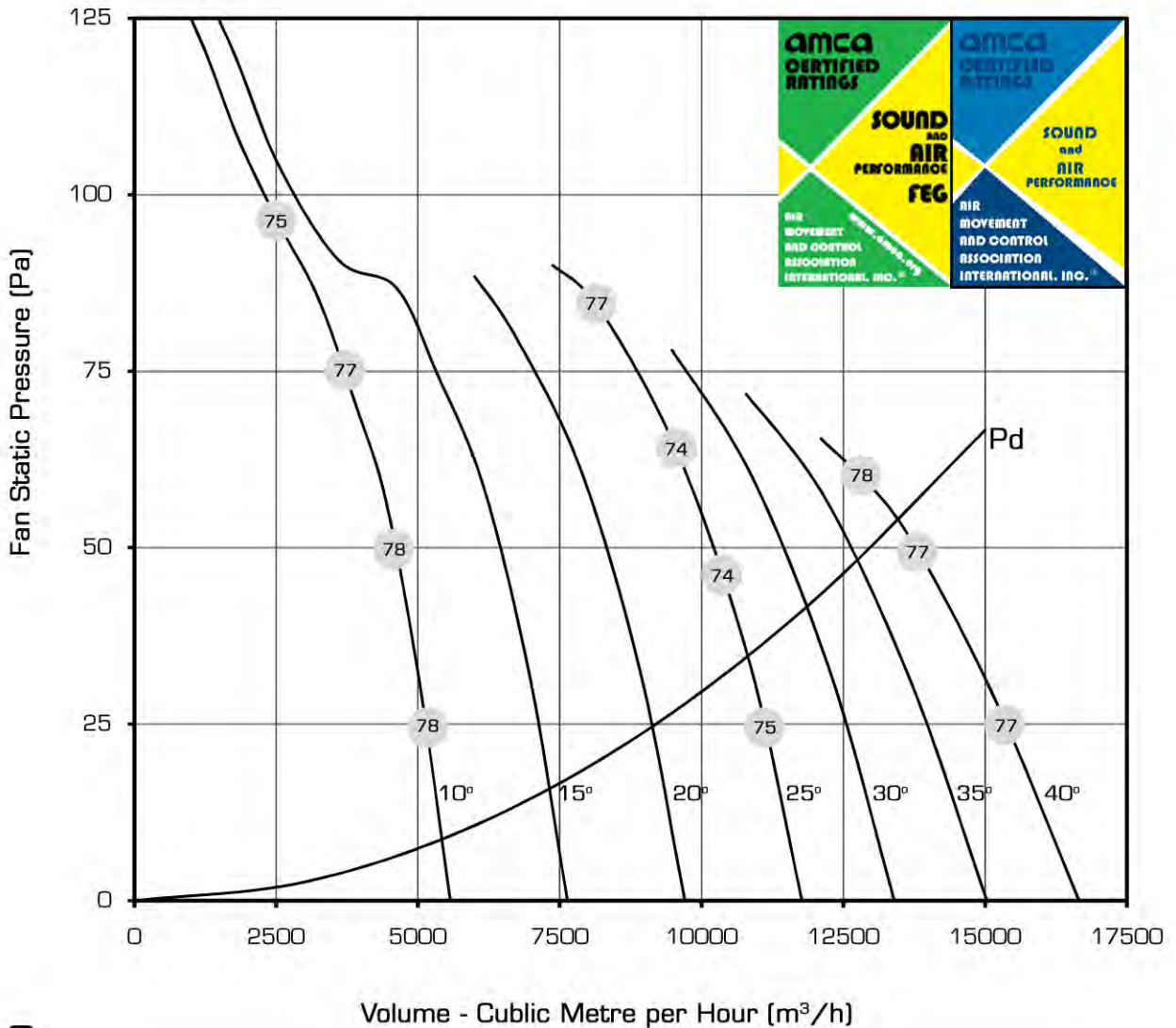

Pitch Angle	10°	15°	20°	25°	30°	35°	40°
Peak kW	0.150	0.241	0.332	0.423	0.530	0.637	0.745

AND 800/12-12/4AL-....
800 mm Diameter 1440 Rpm 50 Hz



Performance certified is for installation type D - Ducted Inlet, Ducted Outlet.
 Performance rating do not include the effects of appurtenances (accessories).
 Values shown are for inlet LW_i A sound power levels for installation type D : ducted inlet, ducted outlet.
 Ratings include the effects of duct end correction.
 The A-weighted sound ratings shown have been calculated per AMCA International Standard 301.

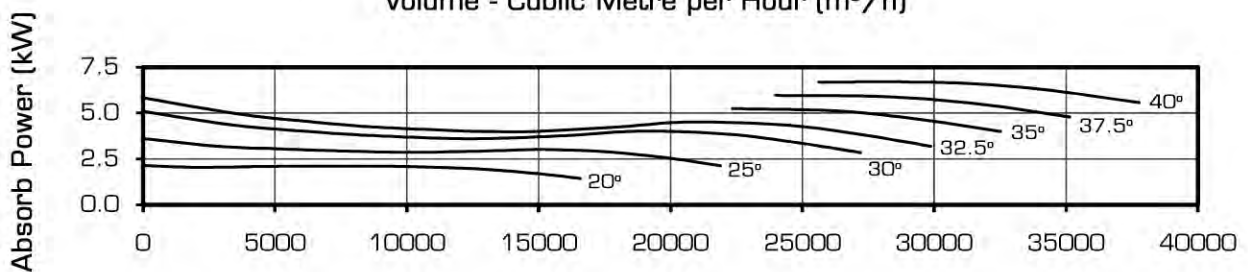
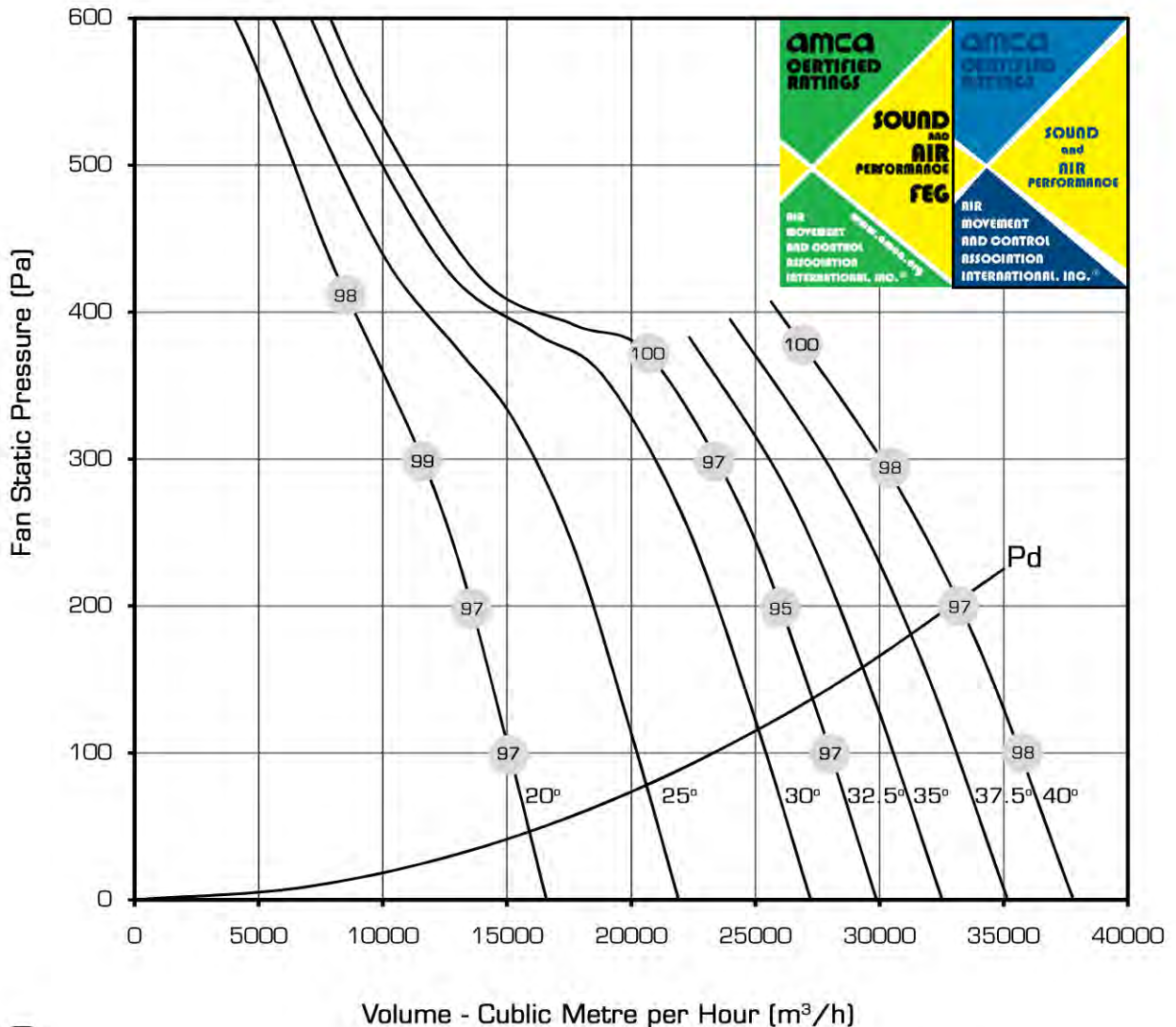

Pitch Angle	20°	25°	30°	32.5°	35°	37.5°	40°
Peak kW	2.151	3.378	4.604	5.931	6.571	7.311	8.051

AND 800/12-12/4AL-....
 800 mm Diameter 960 Rpm 50 Hz

Performance certified is for installation type D - Ducted Inlet, Ducted Outlet.
 Performance rating do not include the effects of appurtenances (accessories).
 Values shown are for inlet LW_i A sound power levels for installation type D : ducted inlet, ducted outlet.
 Ratings include the effects of duct end correction.
 The A-weighted sound ratings shown have been calculated per AMCA International Standard 301.

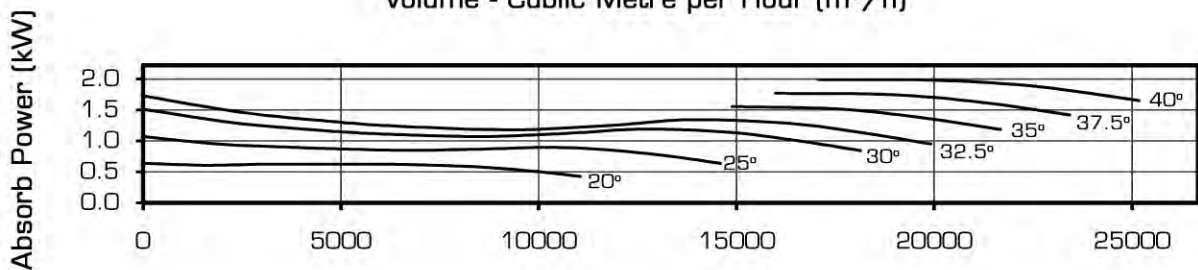
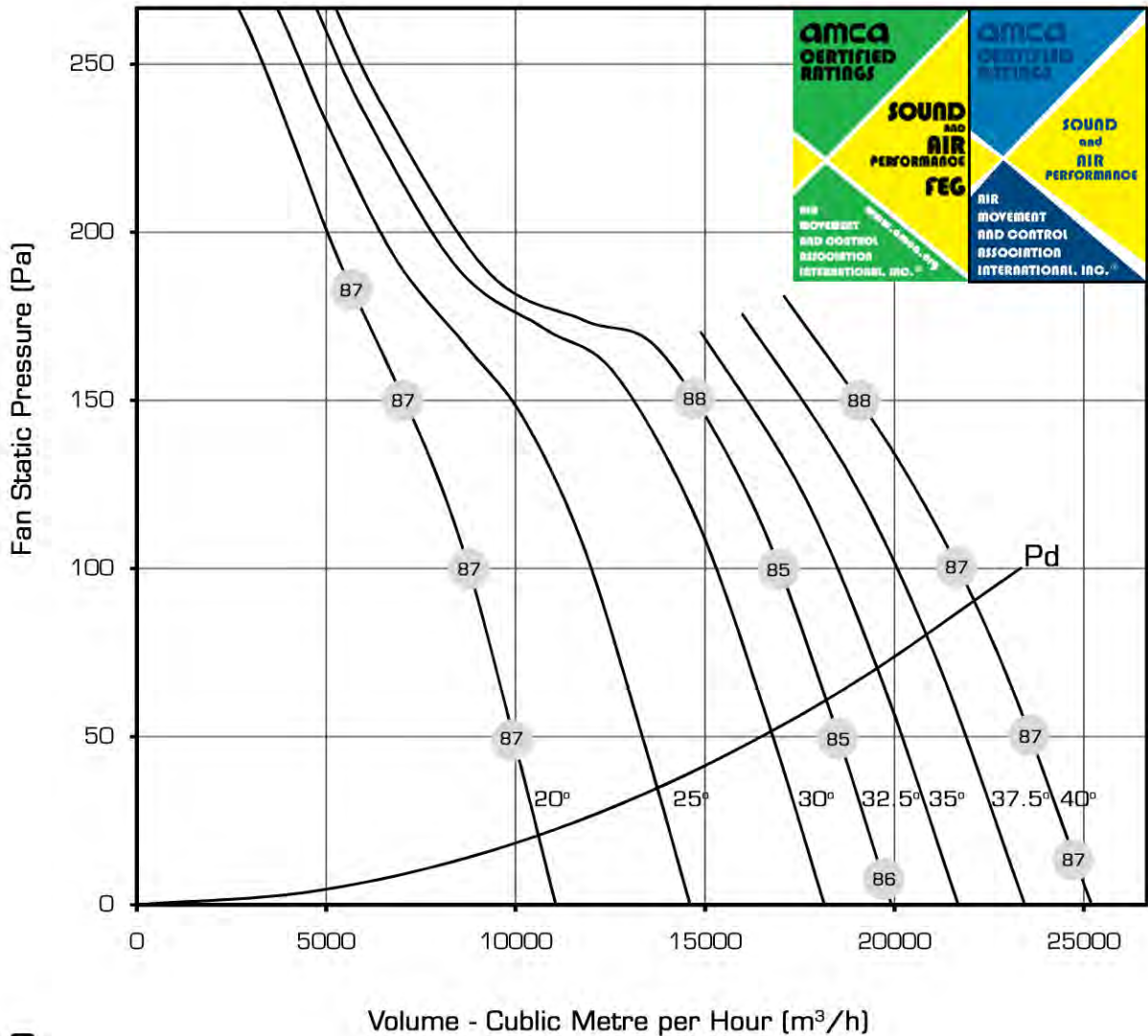

Pitch Angle	20°	25°	30°	32.5°	35°	37.5°	40°
Peak kW	0.637	1.073	1.510	1.728	1.947	2.166	2.385

AND 800/12-12/4AL-....
800 mm Diameter 720 Rpm 50 Hz

Performance certified is for installation type D - Ducted Inlet, Ducted Outlet.
 Performance rating do not include the effects of appurtenances (accessories).
 Values shown are for inlet LW_i A sound power levels for installation type D : ducted inlet, ducted outlet.
 Ratings include the effects of duct end correction.
 The A-weighted sound ratings shown have been calculated per AMCA International Standard 301.

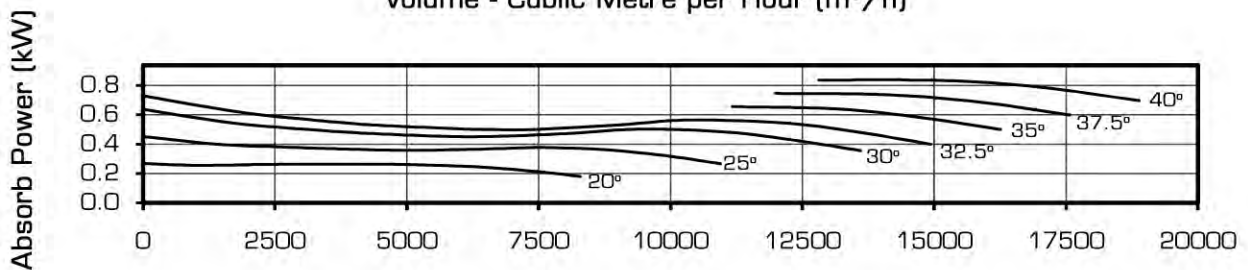
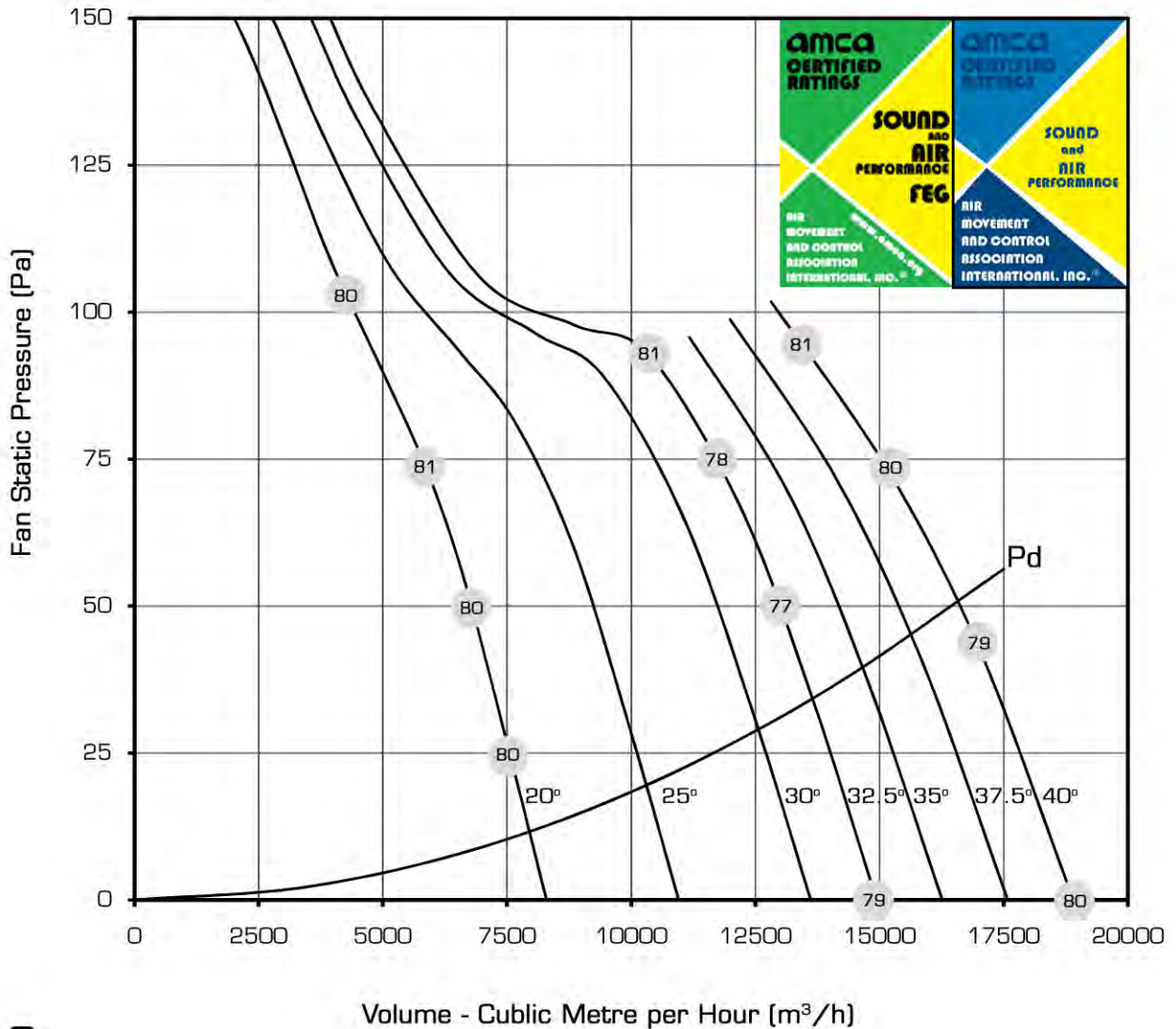

Pitch Angle	20°	25°	30°	32.5°	35°	37.5°	40°
Peak kW	0.269	0.453	0.637	0.729	0.821	0.914	1.006

AND 900/12-12/5AL-....
 900 mm Diameter 1440 Rpm 50 Hz

Performance certified is for installation type D - Ducted Inlet, Ducted Outlet.
 Performance rating do not include the effects of appurtenances (accessories).
 Values shown are for inlet LW_i A sound power levels for installation type D : ducted inlet, ducted outlet.
 Ratings include the effects of duct end correction.
 The A-weighted sound ratings shown have been calculated per AMCA International Standard 301.

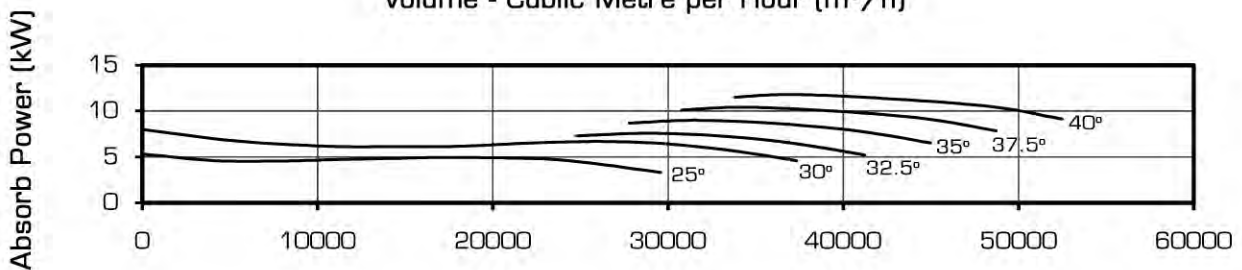
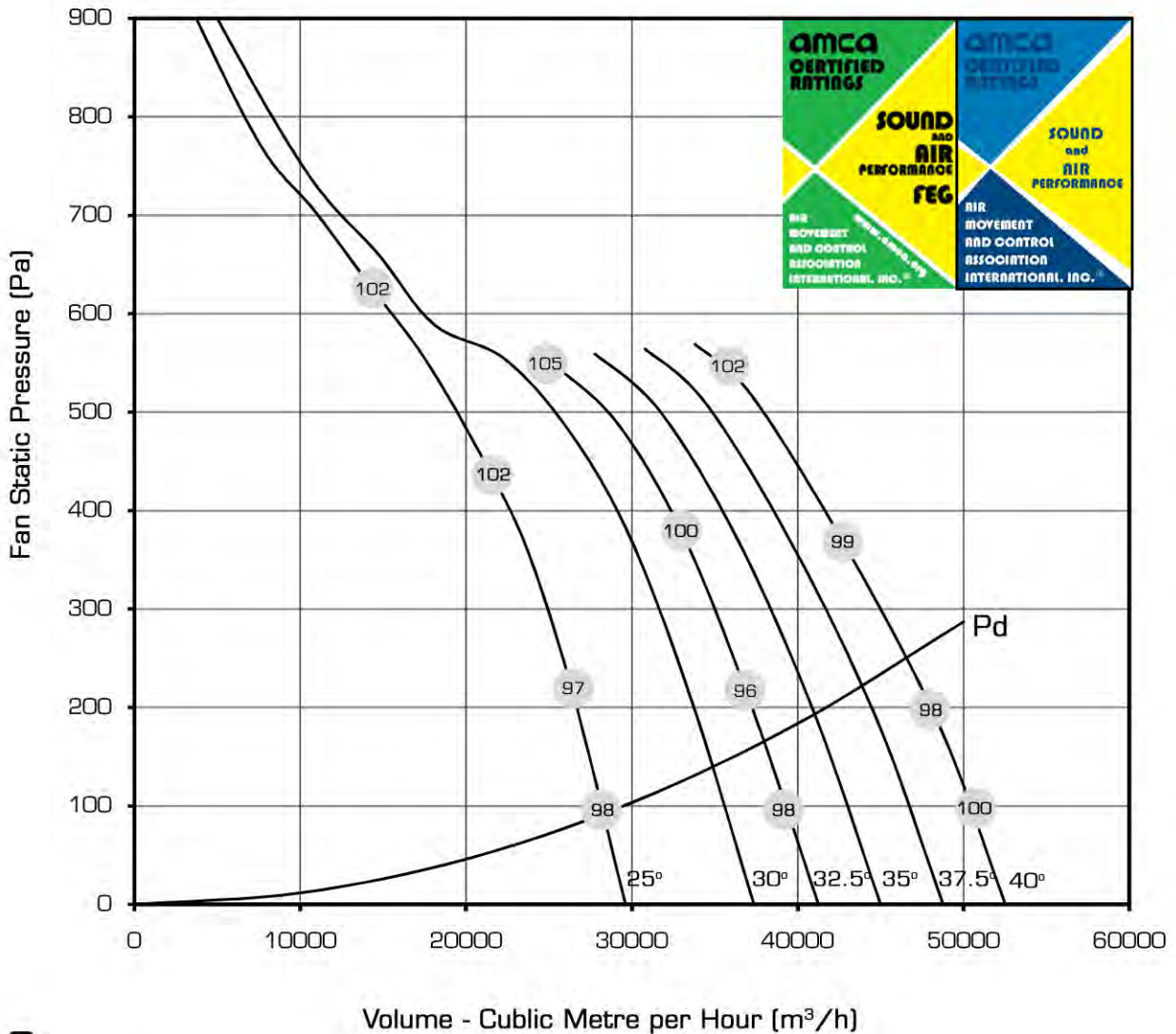

Pitch Angle	25°	30°	32.5°	35°	37.5°	40°
Peak kW	4.998	7.462	8.694	10.053	11.412	12.771

AND 900/12-12/5AL-....
 900 mm Diameter 960 Rpm 50 Hz

Performance certified is for installation type D - Ducted Inlet, Ducted Outlet.
 Performance rating do not include the effects of appurtenances (accessories).
 Values shown are for inlet LW_i A sound power levels for installation type D : ducted inlet, ducted outlet.
 Ratings include the effects of duct end correction.
 The A-weighted sound ratings shown have been calculated per AMCA International Standard 301.

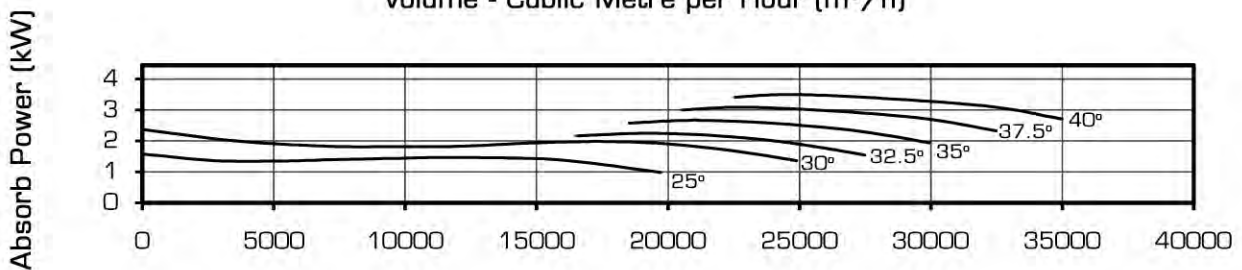
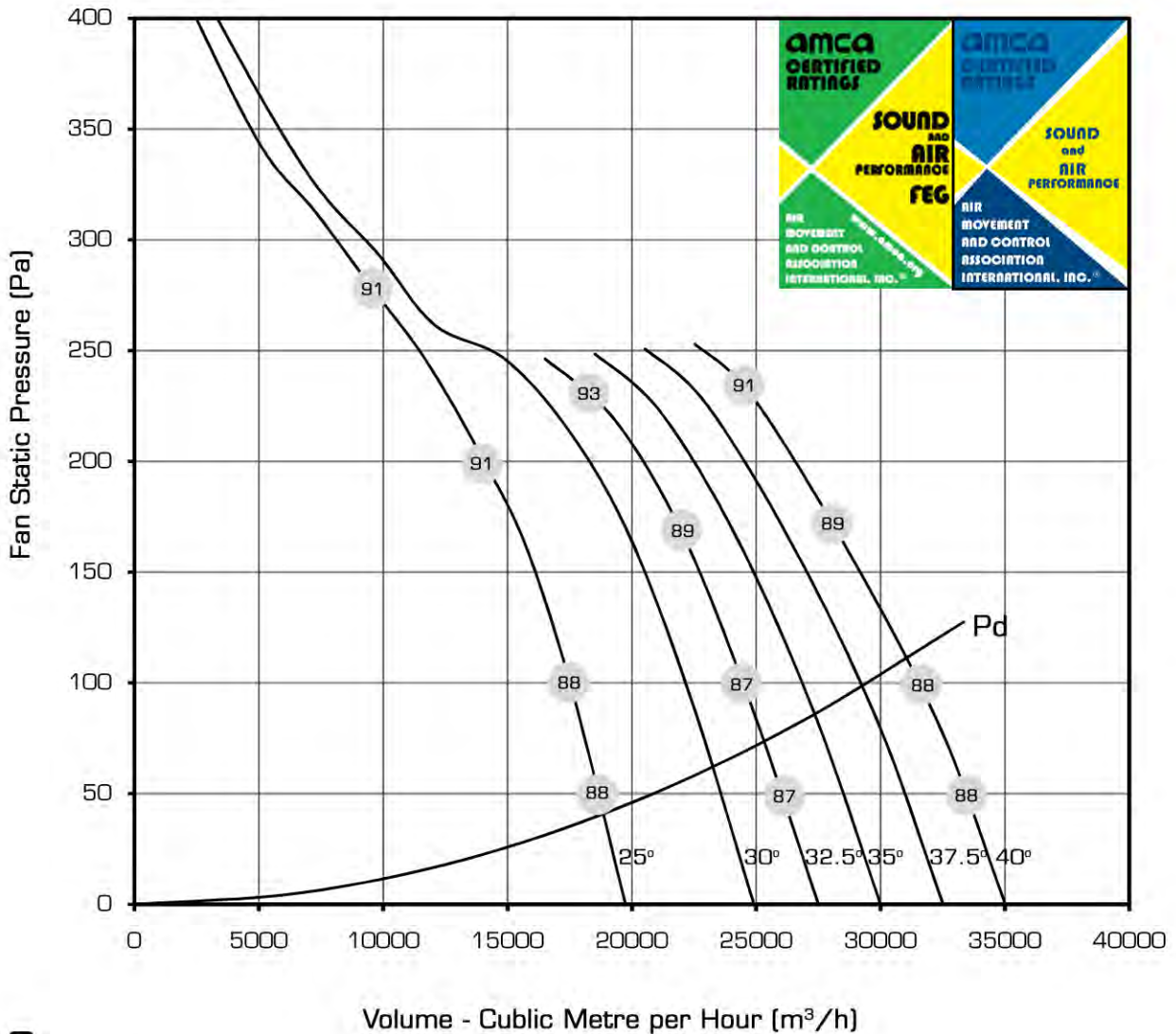

Pitch Angle	25°	30°	32.5°	35°	37.5°	40°
Peak kW	1.481	2.211	2.576	2.979	3.381	3.784

AND 900/12-12/5AL-....
900 mm Diameter 720 Rpm 50 Hz

Performance certified is for installation type D - Ducted Inlet, Ducted Outlet.
Performance rating do not include the effects of appurtenances (accessories).
Values shown are for inlet LW_i A sound power levels for installation type D : ducted inlet, ducted outlet.
Ratings include the effects of duct end correction.
The A-weighted sound ratings shown have been calculated per AMCA International Standard 301.

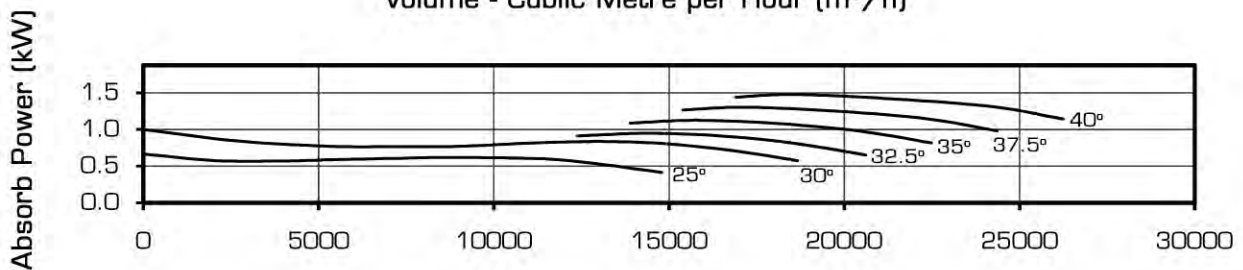
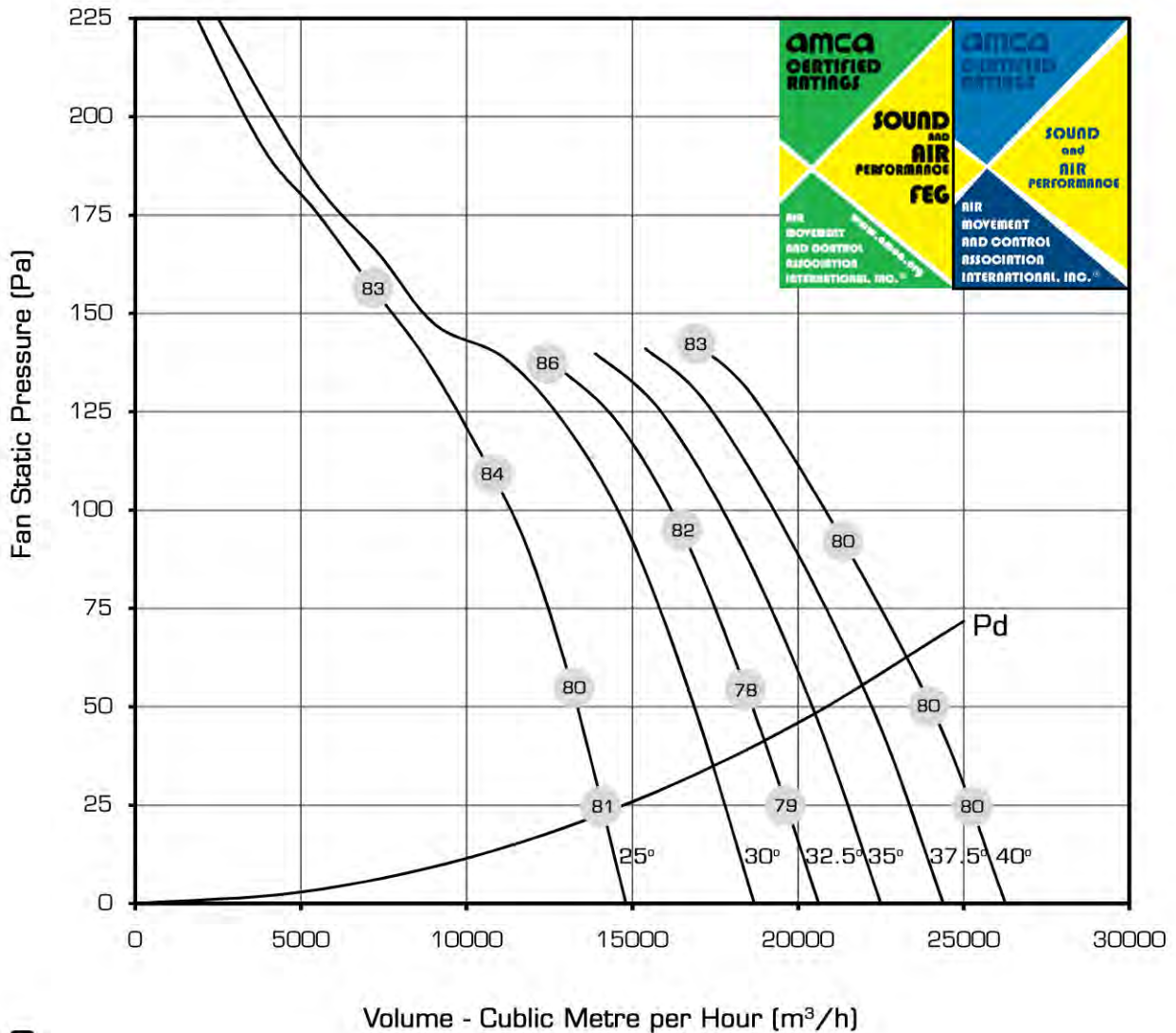

Pitch Angle	25°	30°	32.5°	35°	37.5°	40°
Peak kW	0.625	0.933	1.087	1.257	1.427	1.596

AND 1000/6-6/6AL-....
 1000 mm Diameter 1440 Rpm 50 Hz

Performance certified is for installation type D - Ducted Inlet, Ducted Outlet.
 Performance rating do not include the effects of appurtenances (accessories).
 Values shown are for inlet LW_i A sound power levels for installation type D : ducted inlet, ducted outlet.
 Ratings include the effects of duct end correction.
 The A-weighted sound ratings shown have been calculated per AMCA International Standard 301.

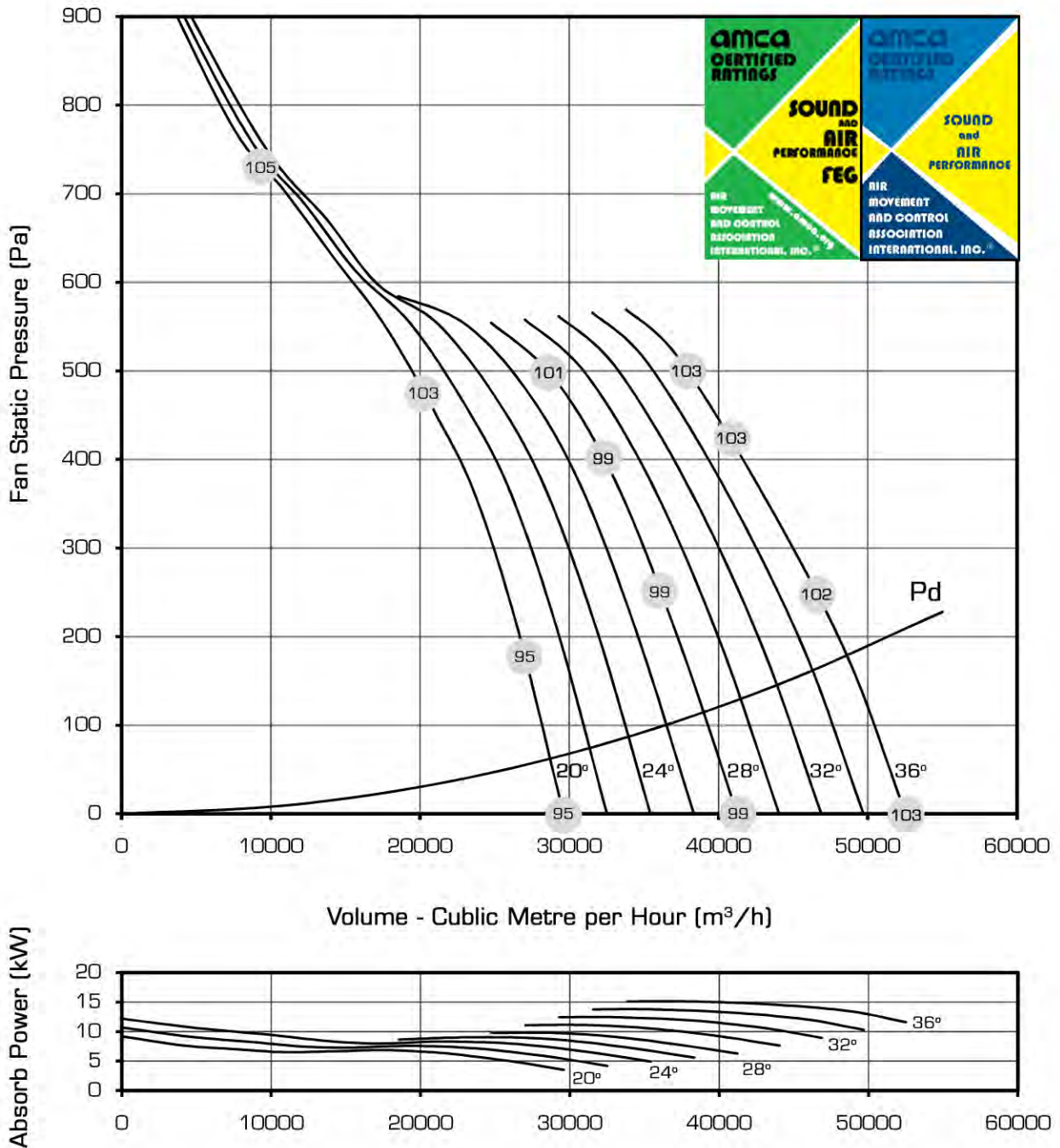

Pitch Angle	20°	22°	24°	26°	28°	30°	32°	34°	36°
Peak kW	9.17	10.67	12.18	13.68	15.18	16.57	17.95	19.34	20.72

AND 1000/6-6/6AL-....
 1000 mm Diameter 960 Rpm 50 Hz

Performance certified is for installation type D - Ducted Inlet, Ducted Outlet.
 Performance rating do not include the effects of appurtenances (accessories).
 Values shown are for inlet LW_i A sound power levels for installation type D : ducted inlet, ducted outlet.
 Ratings include the effects of duct end correction.
 The A-weighted sound ratings shown have been calculated per AMCA International Standard 301.

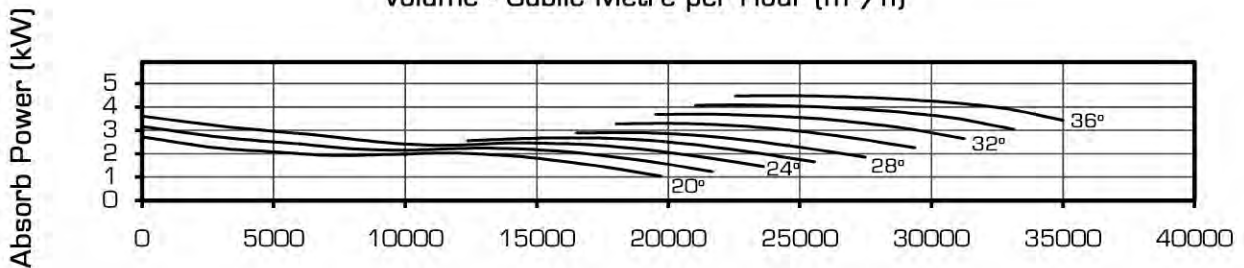
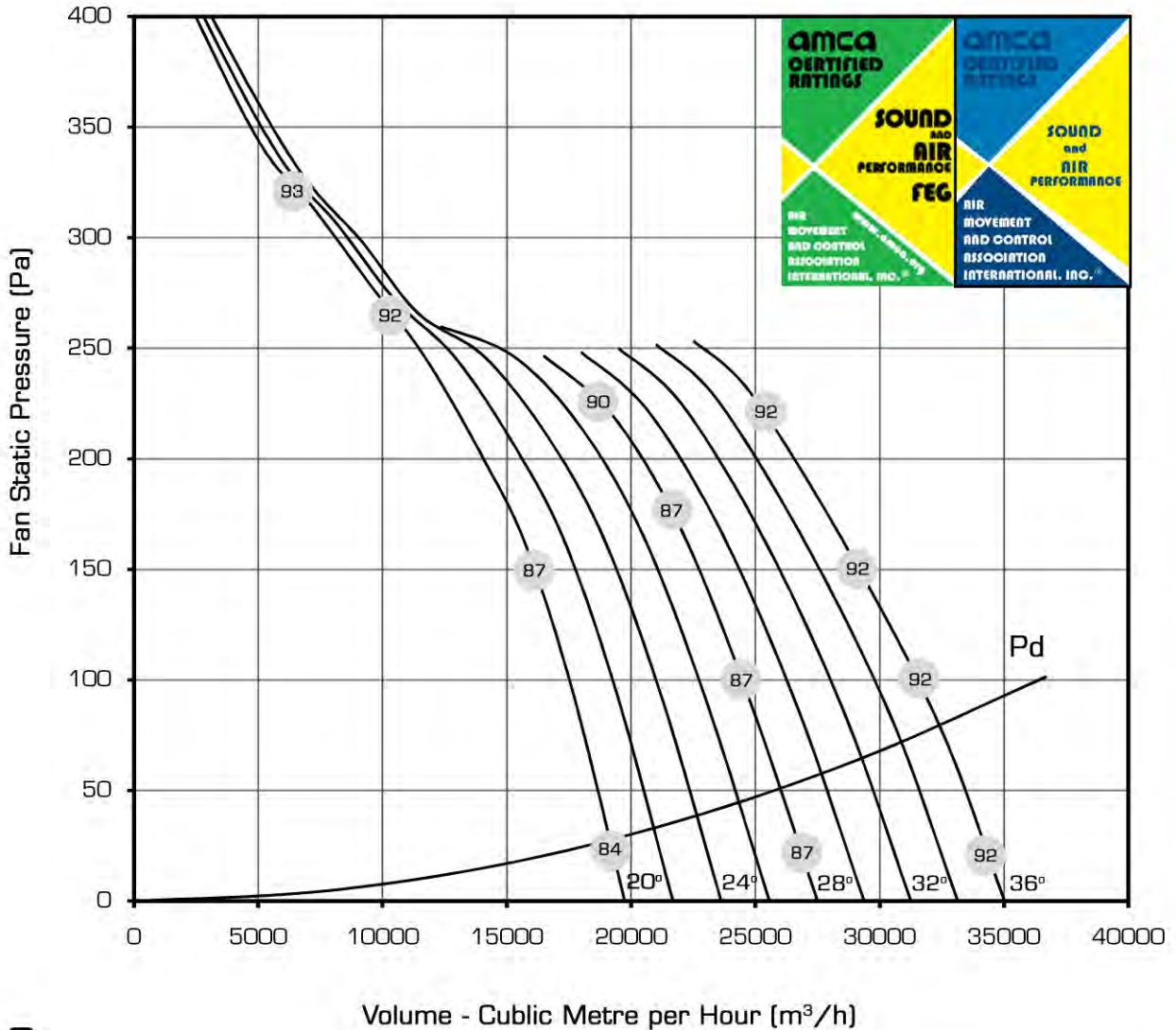

Pitch Angle	20°	22°	24°	26°	28°	30°	32°	34°	36°
Peak kW	2.72	3.16	3.61	4.05	4.50	4.91	5.32	5.73	6.14

AND 1000/6-6/6AL-....
 1000 mm Diameter 720 Rpm 50 Hz

Performance certified is for installation type D - Ducted Inlet, Ducted Outlet.
 Performance rating do not include the effects of appurtenances (accessories).
 Values shown are for inlet LW_i A sound power levels for installation type D : ducted inlet, ducted outlet.
 Ratings include the effects of duct end correction.
 The A-weighted sound ratings shown have been calculated per AMCA International Standard 301.

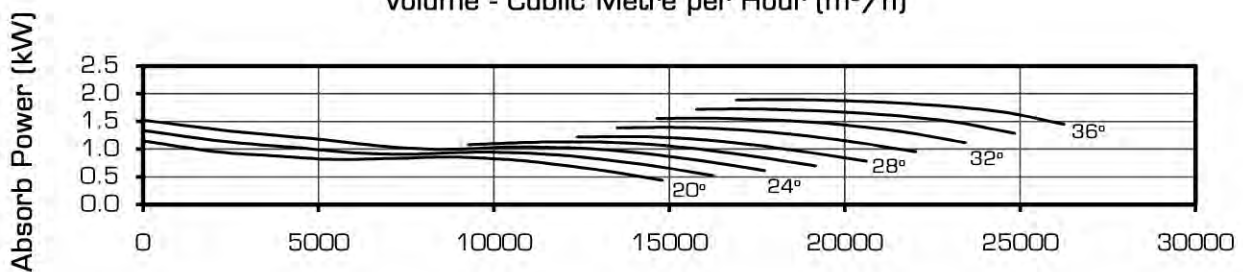
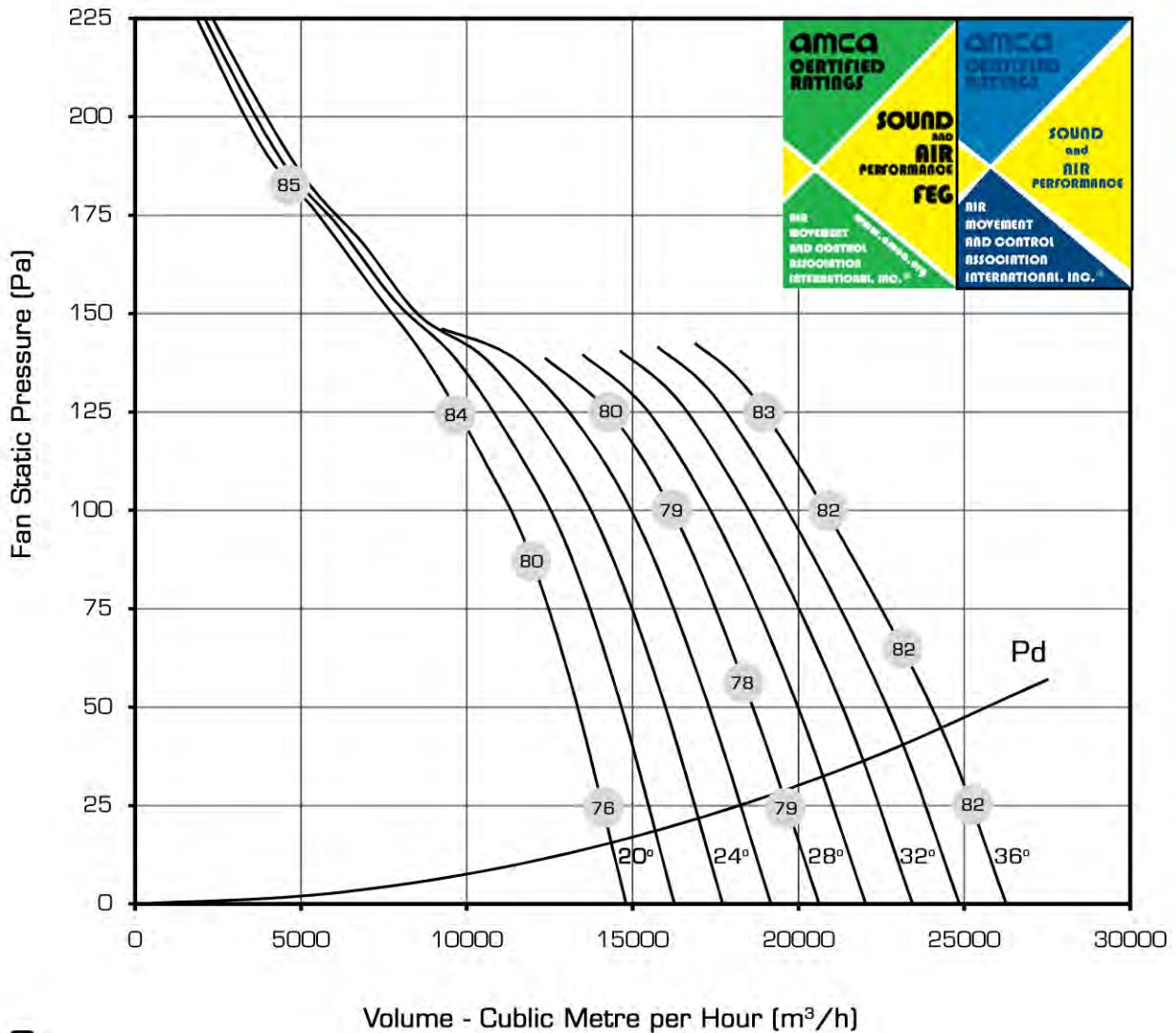

Pitch Angle	20°	22°	24°	26°	28°	30°	32°	34°	36°
Peak kW	1.15	1.33	1.52	1.71	1.90	2.07	2.24	2.42	2.59

AND 1120/8-8/6AL -
1120 mm Diameter 1440 Rpm 50 Hz

Performance certified is for installation type D - Ducted Inlet, Ducted Outlet.
 Performance rating do not include the effects of appurtenances (accessories).
 Values shown are for inlet LW_i A sound power levels for installation type D : ducted inlet, ducted outlet.
 Ratings include the effects of duct end correction.
 The A-weighted sound ratings shown have been calculated per AMCA International Standard 301.

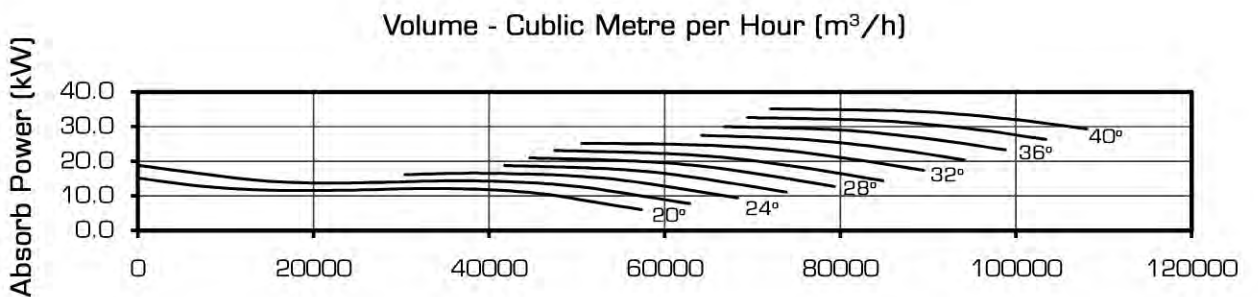
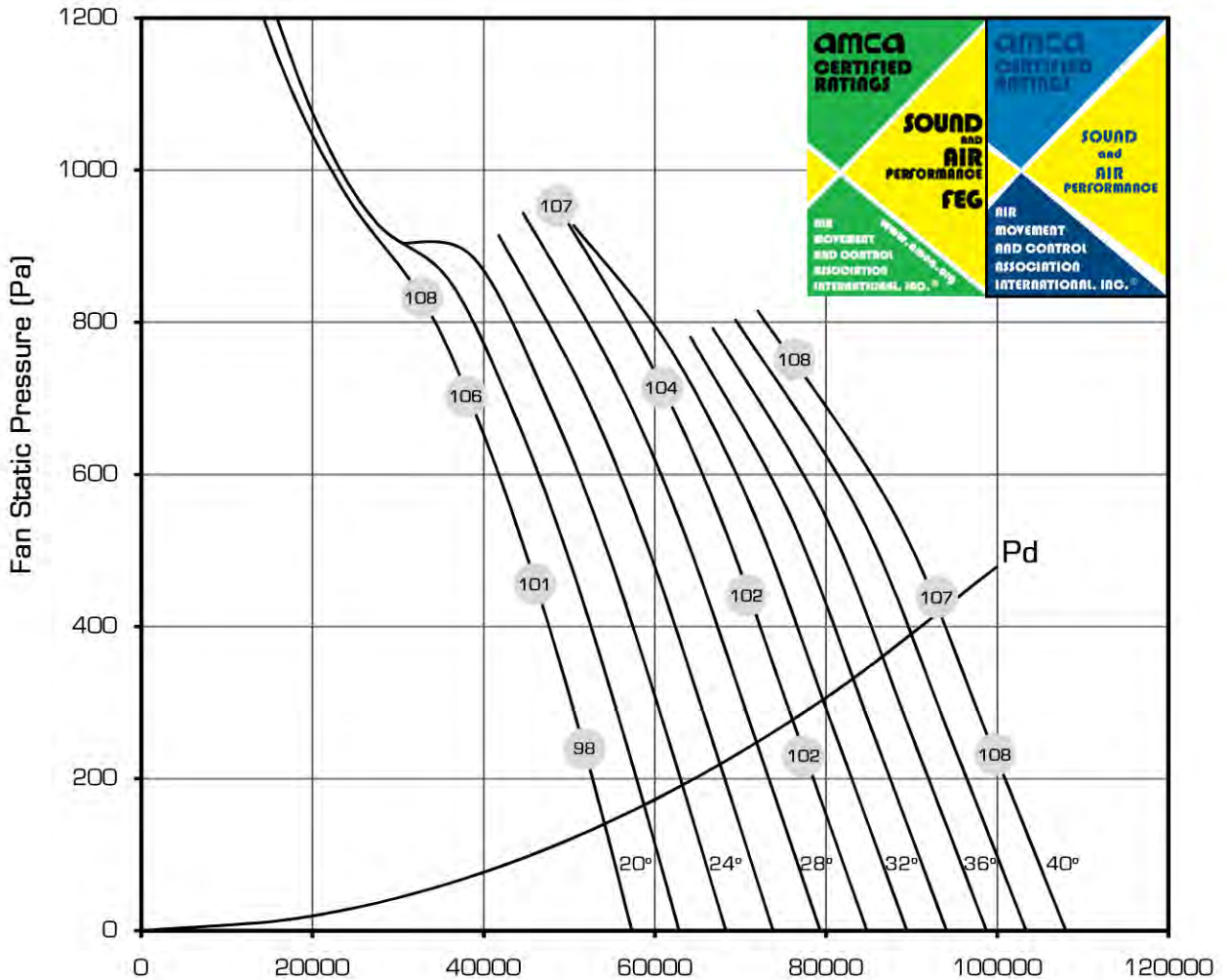

Pitch Angle	20°	22°	24°	26°	28°	30°	32°	34°	36°	38°	40°
Peak kW	15.16	18.88	22.59	26.31	30.02	33.74	36.44	39.13	41.83	44.53	47.22

AND 1120/8-8/6AL -
 1120 mm Diameter 960 Rpm 50 Hz



Performance certified is for installation type D - Ducted Inlet, Ducted Outlet.
 Performance rating do not include the effects of appurtenances (accessories).
 Values shown are for inlet LW_i A sound power levels for installation type D : ducted inlet, ducted outlet.
 Ratings include the effects of duct end correction.
 The A-weighted sound ratings shown have been calculated per AMCA International Standard 301.

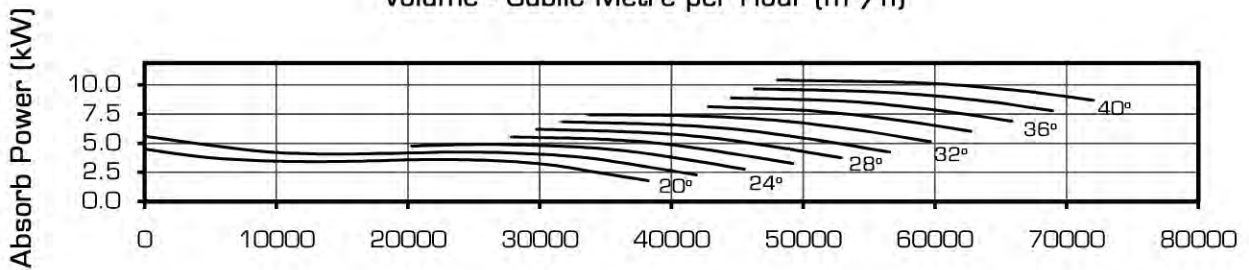
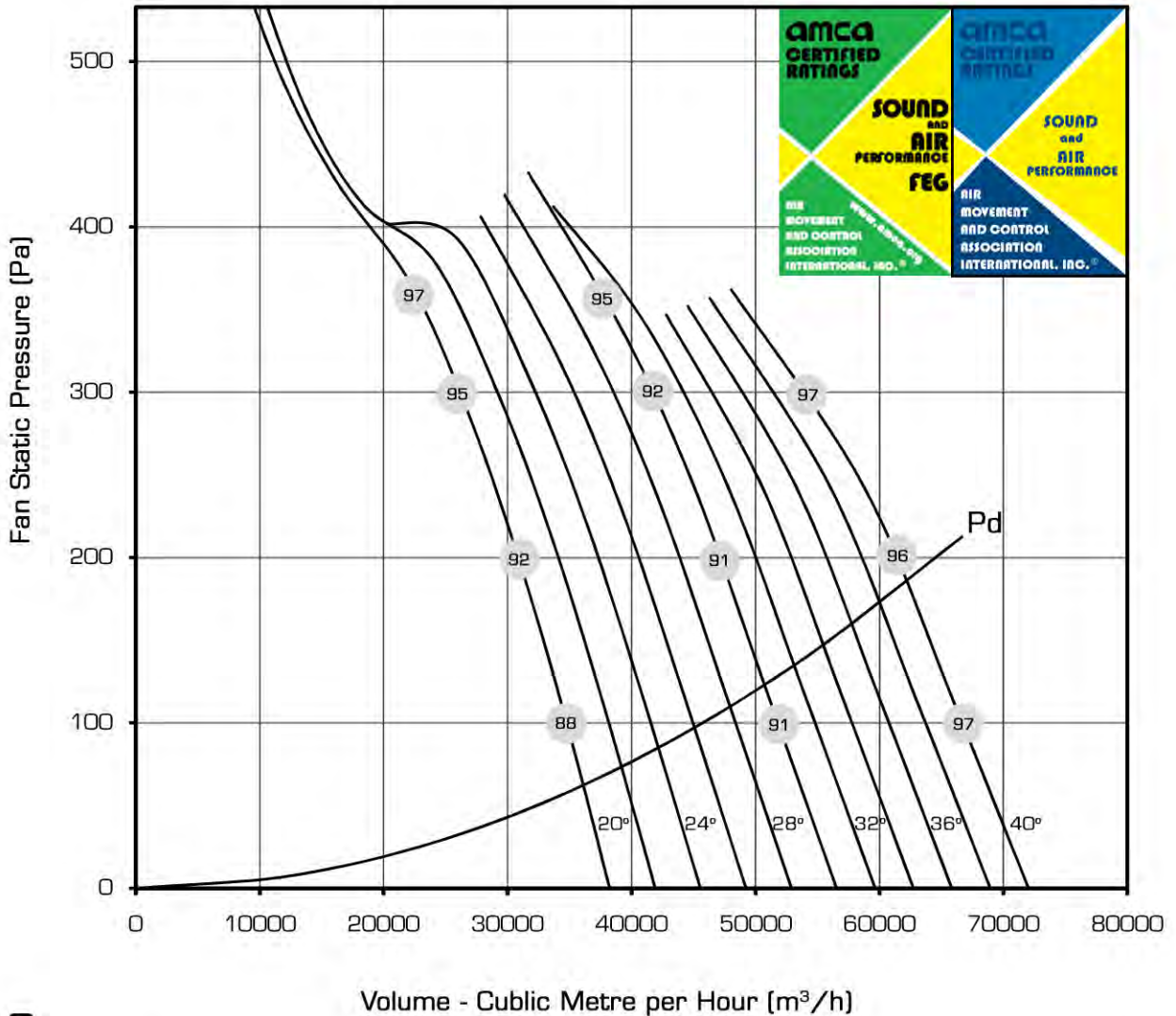

Pitch Angle	20°	22°	24°	26°	28°	30°	32°	34°	36°	38°	40°
Peak kW	4.50	5.60	6.70	7.80	8.90	10.00	10.80	11.60	12.40	13.20	14.00

AND 1120/8-8/6AL -
 1120 mm Diameter 720 Rpm 50 Hz

Performance certified is for installation type D - Ducted Inlet, Ducted Outlet.
 Performance rating do not include the effects of appurtenances (accessories).
 Values shown are for inlet LW_i A sound power levels for installation type D : ducted inlet, ducted outlet.
 Ratings include the effects of duct end correction.
 The A-weighted sound ratings shown have been calculated per AMCA International Standard 301.

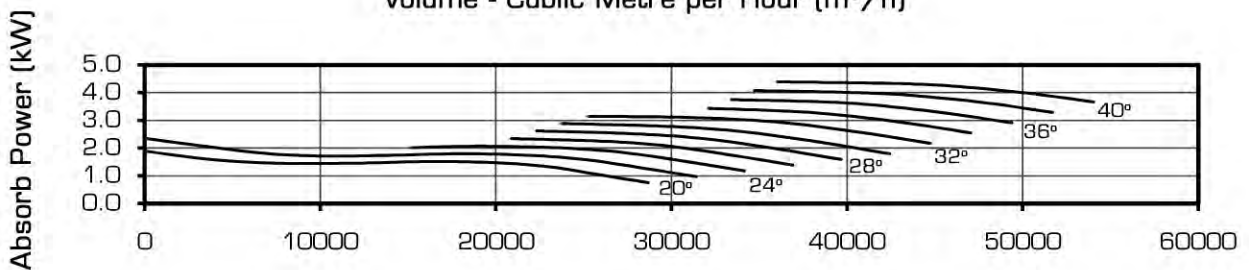
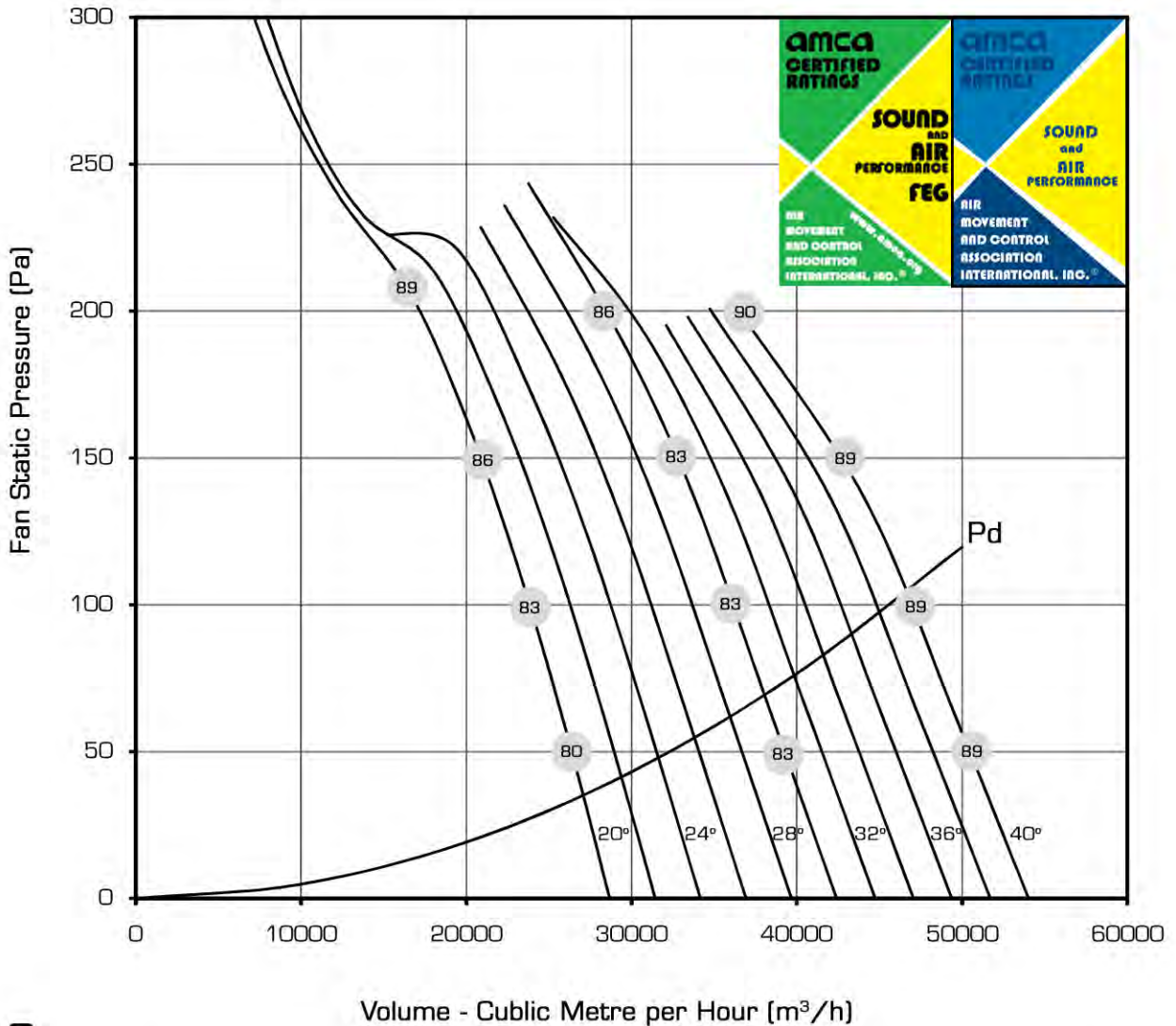

Pitch Angle	20°	22°	24°	26°	28°	30°	32°	34°	36°	38°	40°
Peak kW	1.90	2.36	2.83	3.29	3.76	4.22	4.56	4.90	5.23	5.57	5.91

AND 1250/8-8/6AL -
 1250 mm Diameter 1440 Rpm 50 Hz

Performance certified is for installation type D - Ducted Inlet, Ducted Outlet.
 Performance rating do not include the effects of appurtenances (accessories).
 Values shown are for inlet LW_i A sound power levels for installation type D : ducted inlet, ducted outlet.
 Ratings include the effects of duct end correction.
 The A-weighted sound ratings shown have been calculated per AMCA International Standard 301.

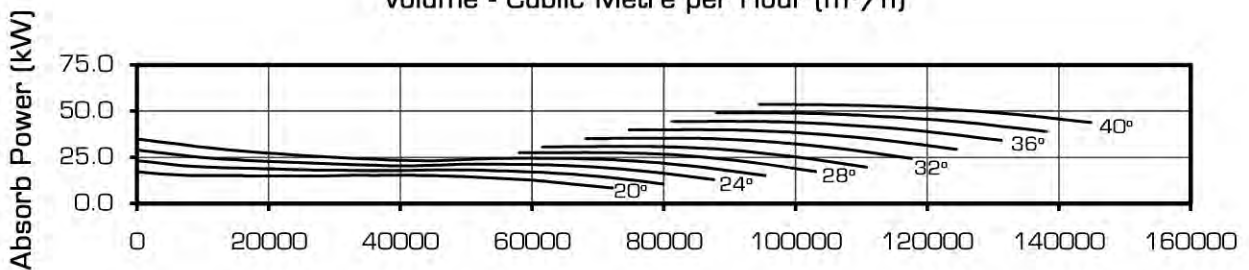
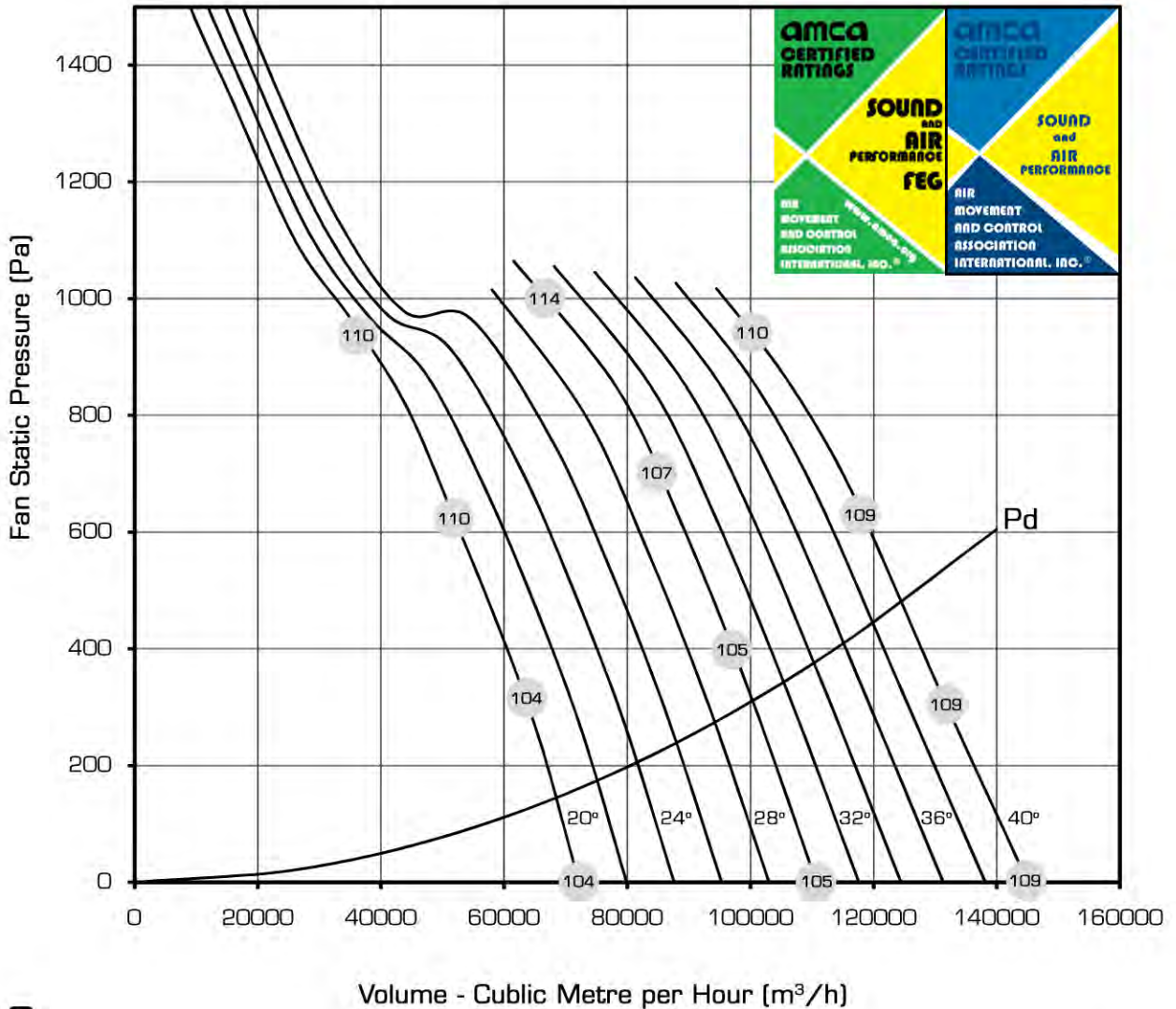

Pitch Angle	20°	22°	24°	26°	28°	30°	32°	34°	36°	38°	40°
Peak kW	17.19	23.10	29.01	34.91	40.82	46.72	51.82	56.93	62.03	67.13	72.23

AND 1250/8-8/6AL -
 1250 mm Diameter 960 Rpm 50 Hz



Performance certified is for installation type D - Ducted Inlet, Ducted Outlet.
 Performance rating do not include the effects of appurtenances (accessories).
 Values shown are for inlet LW_i A sound power levels for installation type D : ducted inlet, ducted outlet.
 Ratings include the effects of duct end correction.
 The A-weighted sound ratings shown have been calculated per AMCA International Standard 301.

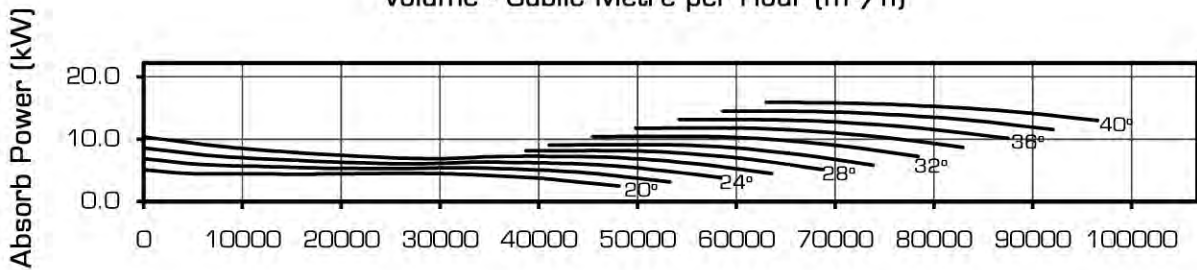
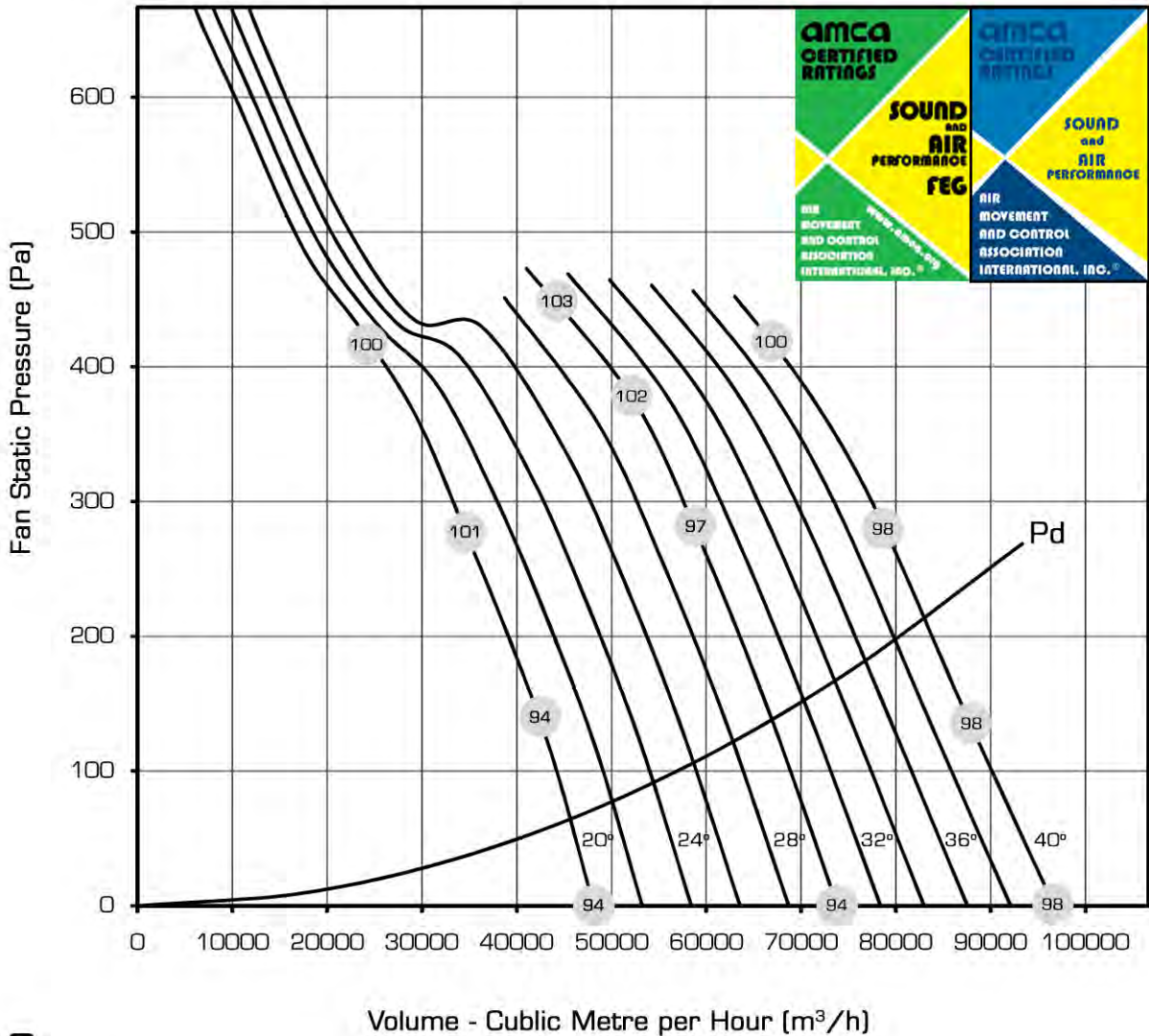

Pitch Angle	20°	22°	24°	26°	28°	30°	32°	34°	36°	38°	40°
Peak kW	5.10	6.45	8.60	10.35	12.10	13.85	15.36	16.87	18.38	19.89	21.40

AND 1250/8-8/6AL -
 1250 mm Diameter 720 Rpm 50 Hz



Performance certified is for installation type D - Ducted Inlet, Ducted Outlet.
 Performance rating do not include the effects of appurtenances (accessories).
 Values shown are for inlet LW_i A sound power levels for installation type D : ducted inlet, ducted outlet.
 Ratings include the effects of duct end correction.
 The A-weighted sound ratings shown have been calculated per AMCA International Standard 301.

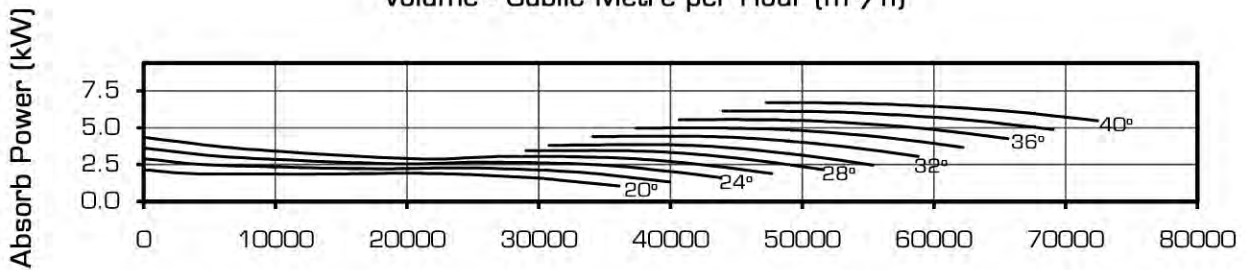
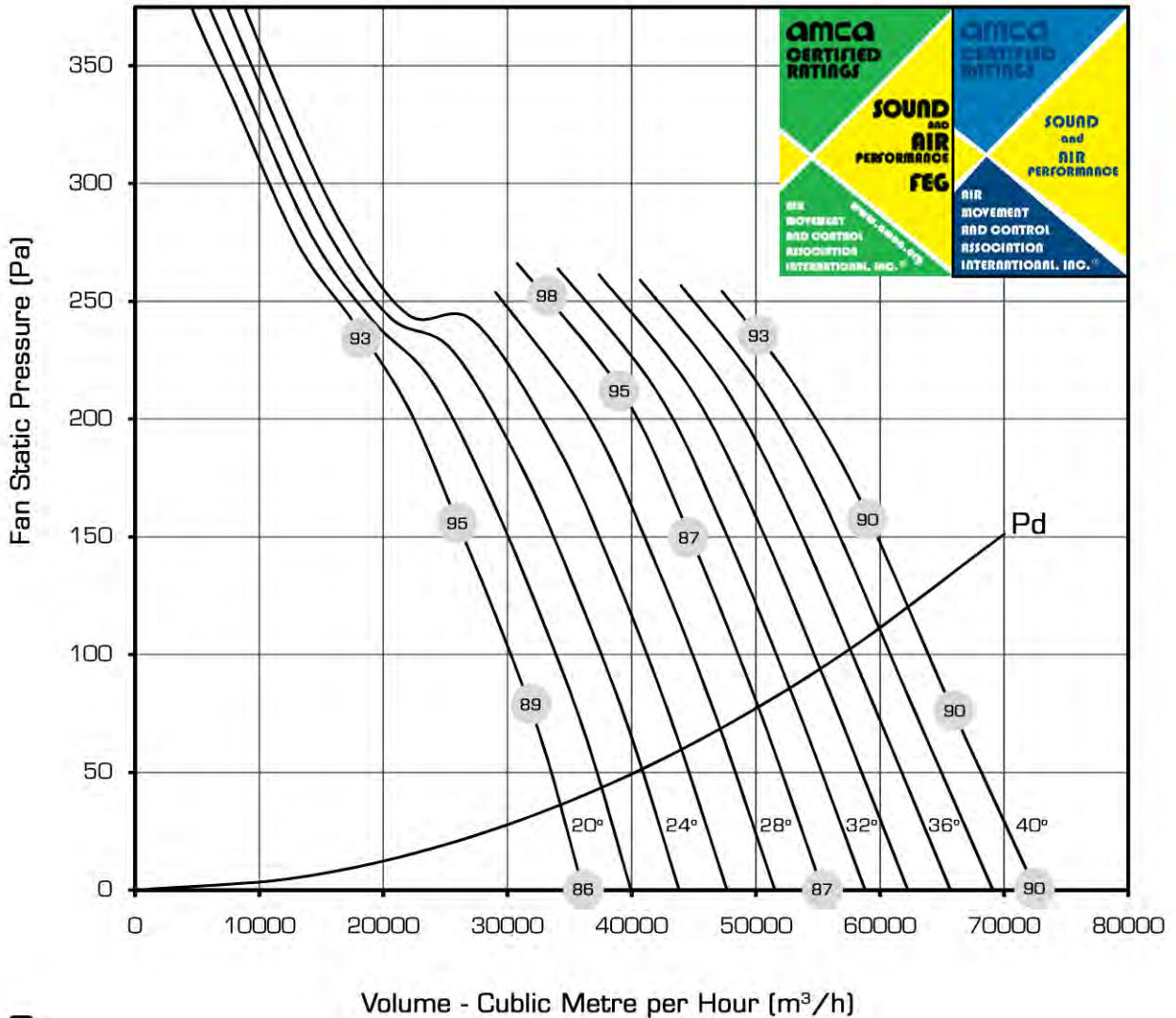

Pitch Angle	20°	22°	24°	26°	28°	30°	32°	34°	36°	38°	40°
Peak kW	2.15	2.89	3.63	4.37	5.11	5.84	6.48	7.12	7.76	8.39	9.03



Rosenberg East Asia Pte Ltd
71 Ubi Crescent #08-04
Excalibur Centre
Singapore 408571

Tel: +65 6846 8866
Fax: +65 6846 1129

www.rosenberg.com.sg
www.rosenberg-gmbh.com