

Vaneaxial

AVD
VANEMASTER™



SYMBOL OF
QUALITY

TABLE OF CONTENTS

	Page No.
Design Features	2-3
Optional Accessories	3
Hub & Blade Combinations	4
Typical Specifications	4
AVD Performance Diagrams	5-8
AVD Dimensions	9
AVD Fan Weight.....	10
Metric Conversion Table.....	10
Typical Installation.....	11
Warranty.....	12

DESIGN FEATURES

Acme Axial Flow Fans

The VANEMASTER™ fans are compact, rugged, and precisely constructed for your airflow-pressure conditions with adjustable pitch blades (at rest).

VANEMASTER™ fans are suited for a large number of air handling applications in commercial, industrial and process ventilation.

Distinguishing features of the VANEMASTER™ fans are space savings, ease of installation and high reliability.

The VANEMASTER™ impeller consists of two assembled hub discs with cavities to house the blades at preset angles. The blades of the rotor can be factory set to any angle between 25° and 60°, dependent on size and speed. The rotor is provided with a hub boss for mounting onto the motor shaft.



BLADE

Aluminum Blades: Special Operating Ranges

- Normal Operating Temperature -4 to 104°F (-20 to 40°C) for standard fans.
- Maximum Temperature Range of the fan is -40 to 302°F (-40 to 150°C) with special motors and/or reduced speeds.

Motors

Standard motors are NEMA frame, flange mounted type.

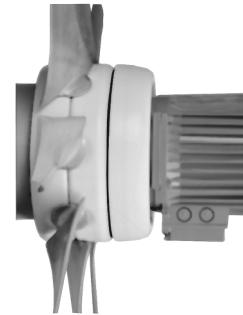

MOTOR/BLADE ASSEMBLY

Adjustment Of Blade Angles

The blade pitch may be manually adjusted to obtain different performances. The rotor must be aligned and balanced before starting. Care must be taken to not exceed the motor output power.

AVD For Duct Installations

The VANEMASTER™ fan line comprises 14 sizes with impeller diameters ranging from 10 to 63 inches (254mm to 1600mm) and 7 hub diameters from 6 to 23 inches (152 mm to 584 mm). Air volumes from 212 to 116,500 CFM (0.01 m³/s to 54.98 m³/s). The fan consists of a cylindrical casing with connecting flanges at both ends.

The mounting for the rotor serves as a downstream guide vane arrangement ensuring extremely high fan efficiency.

The motor is flange-mounted and is provided with extended leads through the fan casing to a terminal box for electrical connection.

Variable Frequency Controls

When designing ventilation and air conditioning systems, the VANEMASTER™ fans with frequency convertors are an excellent alternative to centrifugal fans with inlet vane controls for systems requiring varying air quantity requirements.



Acme Engineering & Manufacturing Corporation certifies that the models shown herein are licensed to bear the AMCA seal. The ratings shown are based on tests and procedures performed in accordance with AMCA Publication 211 and AMCA Publication 311 and comply with the requirements of the AMCA Certified Ratings Program.

The sound ratings shown are loudness values in fan sones at 5 feet (1.524 m) in a spherical free field calculated per AMCA Standard 301. Values are shown are for Installation Type A: Free Inlet spherical sone levels.



Model AVD is Listed for (UL/C-UL 705) File No. E39982.

Consult your Acme representative for availability.

DESIGN FEATURES

Investment, operating costs, and space requirements are lower for VANEMASTER™ fans used in combination with frequency converters that make even small installations economical.

The simple construction of VANEMASTER™ fans provides a stable structure which minimizes vibration. Normally there is only one or more vibration modes in which the associated speed(s) must be avoided. This is easily accomplished by programming the variable frequency control.

As may be seen in the table, frequency control permits speeds and capacities in excess of the standard motor rating. Care must be taken to not exceed the available motor output power or the maximum rotor speed.

Contrary to fixed speed fans, the use of speed regulation improves sound as lower speeds result in lower sound power levels.

Max Speed (RPM) of VANEMASTER™ Rotors At 70 F (21 C)*														
Hub	NOMINAL WHEEL SIZE (mm)													
	250	315	400	500	560	630	710	800	900	1000	1120	1250	1400	1600
160	5827	5080	4436	3943										
230			4695	4112	3865	3676	3393	2993						
280				4012	3755	3536	3334	3058	2571					
330				3977	3686	3448	3215	2973	2665					
380					3674	3388	3097	2859	2651	2324				
403									2279	2125	1985	1833	1710	
578									2128	1957	1804	1673	1553	1444

*Maximum allowable speeds may be adjusted for temperatures higher or lower than 70°F

OPTIONAL ACCESSORIES

Mounting feet

Outlet Guard

Vibration Isolation mountings

Curb Cap(Sizes 400-1250)

Discharger Hood
(Sizes 250-900)

Diffuser for outlet (short & long)

Inlet/Guard

Outlet Diffusers
(Sizes 800-1600)

For sizing or details of these accessories please review the appropriate drawings.

Inlet Bell

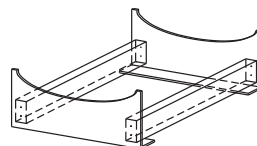
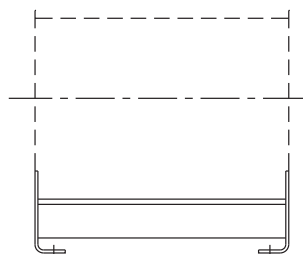
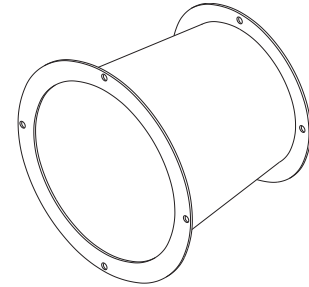
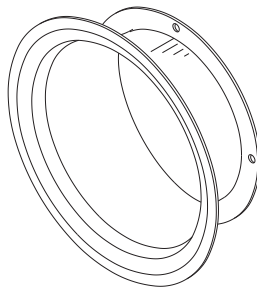
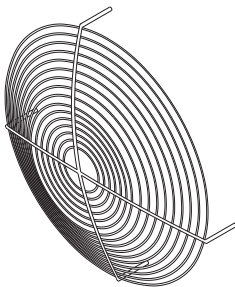

Diffusers create lower discharge velocity thus recovering some static pressure. Diffuser can also be used on the inlet for duct size differences.

Mounting Feet, Horizontal Air Flow.

HUB AND BLADE COMBINATIONS

Hub dia. (mm)	Number of Blades	FAN DIAMETER (mm)													
		250	315	400	500	560	630	710	800	900	1000	1120	1250	1400	1600
160	4	•	•	•	•										
230	6			•	•	•	•	•	•						
280	8				•	•	•	•	•	•					
330	10				•	•	•	•	•	•					
380	12					•	•	•	•	•	•				
403	6									•	•	•	•	•	
578	10									•	•	•	•	•	•

AVD VANEMASTER™ fans should be specified by giving both the fan diameter and the hub diameter. A typical fan selection example would be AVD 1000/403. Additional data concerning motor RPM, voltage, Hz and accessories are required to create the proper fan selection for each application.

TYPICAL SPECIFICATIONS

Vane Axial fans shall be Direct Driven, Arrangement 4, with the motor located downstream from the impeller. Impeller blades are to be made of a high strength, corrosion resistant, aluminum alloy. Blades are to be die cast for maximum efficiency and low noise levels. The impeller hubs are to be die-formed of galvanized steel with angle location marks to allow accurate blade setting at the factory or in the field.

The impeller shall be positively secured to the motor shaft. The impeller is to be statically and dynamically balanced.

Fan housings shall be constructed of heavy gauge steel with integral prepunched flanges for leak-free performance. High efficiency, straightening vanes of heavy gauge steel are to be installed to eliminate air swirl and regain static pressure. The vanes are to be designed to support the motor and welded to the housings in a manner designed to reduce air turbulence. Fans to be supplied with limited two year warranty.

Vane Axial fans shall be model AVD as manufactured by Acme Engineering & Manufacturing Corporation of Muskogee, Oklahoma. Sizes and performance as shown on the plans.

AVD PERFORMANCE

AVD 560/330-10
1470 RPM
37° Blade Angle

Air Performance						
CFM	4958	4388	3901	3432	2925	2442
Static Pressure	0.000	0.486	0.854	1.099	1.247	1.217
Total Pressure	0.219	0.656	0.988	1.202	1.322	1.269
Max HP	.92					

Sound Data		
Static Pressure	Spherical Sones	LwA
0.00	14.1	81
0.47	12.9	80
0.89	13.9	81
1.21	21	88

AVD 710/280-8
1470 RPM
43° Blade Angle

Air Performance								
CFM	10954	9854	8760	7672	6642	5485	4320	3345
Static Pressure	0.000	0.398	0.722	0.945	1.068	1.143	1.232	1.439
Total Pressure	0.160	0.521	0.819	1.019	1.124	1.181	1.256	1.453
Max HP	2.09							

Sound Data		
Static Pressure	Spherical Sones	LwA
0.00	20	87
0.31	20	87
0.58	21	87
0.86	26	92

AVD 710/330-10
1470 RPM
45° Blade Angle

Air Performance					
CFM	11913	10738	9568	8388	7155
Static Pressure	0.000	0.518	0.966	1.334	1.536
Total Pressure	0.493	0.914	1.280	1.575	1.711
Max HP	3.03				

Sound Data		
Static Pressure	Spherical Sones	LwA
0.00	21	87
0.64	20	87
1.24	26	92
1.39	31	95

Performance certified is for Installation Type B: Free inlet, ducted outlet.
 Performance ratings do not include the effects of appurtenances (accessories).
 The A-weighted sound power ratings shown have been calculated per AMCA Standard 301.
 Values shown are for (Inlet LwA) sound power levels for: Installation Type B: free inlet, ducted outlet.
 The sound ratings shown are loudness values in fan sones at 1.5 m (5 ft) in a spherical free field calculated per AMCA Standard 301.
 Values shown are for Installation Type B: free inlet spherical sone levels.

AVD PERFORMANCE

AVD 800/380-12 1470 RPM 39° Blade Angle

Air Performance								
CFM	13886	12535	11169	9804	8383	7019	5543	4130
Static Pressure	0.000	0.620	1.169	1.589	1.827	2.012	2.122	2.260
Total Pressure	0.426	0.966	1.443	1.800	1.980	2.120	2.189	2.297
Max HP	3.62							

Sound Data		
Static Pressure	Spherical Sones	LwA
0.00	27	91
0.80	26	91
1.40	37	98
1.70	44	101

AVD 900/380-12 1470 RPM 43° Blade Angle

Air Performance									
CFM	20368	18349	16355	14345	12373	10113	8273	6168	3426
Static Pressure	0.000	0.647	1.205	1.645	1.911	2.111	2.214	2.391	2.774
Total Pressure	0.541	1.085	1.552	1.911	2.109	2.243	2.302	2.440	2.789
Max HP	5.78								

Sound Data		
Static Pressure	Spherical Sones	LwA
0.10	34	95
0.70	33	95
1.30	46	101
1.90	62	106

AVD 1000/403-6 1470 RPM 39° Blade Angle

Air Performance									
CFM	27190	24566	21776	19088	16426	13396	10909	8188	3768
Static Pressure	0.00	0.697	1.416	1.990	2.377	2.758	2.919	3.016	3.808
Total Pressure	0.627	1.203	1.813	2.294	2.602	2.908	3.018	3.072	3.820
Max HP	8.79								

Sound Data		
Static Pressure	Spherical Sones	LwA
0.00	40	97
1.00	37	97
2.00	47	102
3.00	66	107

Performance certified is for Installation Type B: Free inlet, ducted outlet.
 Performance ratings do not include the effects of appurtenances (accessories).
 The A-weighted sound power ratings shown have been calculated per AMCA Standard 301.
 Values shown are for (Inlet LwA) sound power levels for: Installation Type B: free inlet, ducted outlet.
 The sound ratings shown are loudness values in fan sones at 1.5 m (5 ft) in a spherical free field calculated per AMCA Standard 301.
 Values shown are for Installation Type B: free inlet spherical sone levels.

AVD PERFORMANCE DIAGRAMS

AVD 1000/578-10
1470 RPM
29° Blade Angle

Air Performance										
CFM	17372	15659	13986	12212	10438	8732	6974	5213	2551	0
Static Pressure	0.00	0.911	1.720	2.433	2.904	3.246	3.638	4.164	4.976	6.276
Total Pressure	0.265	1.122	1.888	2.561	2.997	3.312	3.679	4.188	4.981	6.276
Max HP	8.67									

Sound Data		
Static Pressure	Spherical Sones	LwA
0.00	48	99
1.50	49	102
3.00	62	106
4.00	63	105

AVD 1000/380-12
1470 RPM
47° Blade Angle

Air Performance									
CFM	30227	27320	24351	21308	18232	15168	12153	9040	4623
Static Pressure	0.00	0.71	1.34	1.85	2.20	2.41	2.43	2.65	2.99
Total Pressure	0.79	1.35	1.84	2.24	2.49	2.60	2.56	2.72	3.00
Max HP	10.72								

Sound Data		
Static Pressure	Spherical Sones	LwA
0.00	41	99
0.63	42	99
1.27	52	102
1.90	68	107

AVD 1120/403-6
1470 RPM
42° Blade Angle

Air Performance									
CFM	39677	35905	32052	28135	24129	20172	16078	12016	5680
Static Pressure	0.00	0.76	1.47	2.11	2.55	2.87	3.04	3.34	4.05
Total Pressure	0.86	1.46	2.03	2.54	2.87	3.09	3.18	3.41	4.07
Max HP	14.75								

Sound Data		
Static Pressure	Spherical Sones	LwA
0.00	51	101
0.82	45	100
1.65	49	101
2.47	83	111

Performance certified is for Installation Type B: Free inlet, ducted outlet.
 Performance ratings do not include the effects of appurtenances (accessories).
 The A-weighted sound power ratings shown have been calculated per AMCA Standard 301.
 Values shown are for (Inlet LwA) sound power levels for: Installation Type B: free inlet, ducted outlet.
 The sound ratings shown are loudness values in fan sones at 1.5 m (5 ft) in a spherical free field calculated per AMCA Standard 301.
 Values shown are for Installation Type B: free inlet spherical sone levels.

AVD PERFORMANCE DIAGRAMS

AVD 1120/578-10
1470 RPM
34° Blade Angle

Air Performance									
CFM	33430	30372	27183	23835	20388	16946	13544	10234	5046
Static Pressure	0.00	1.22	2.33	3.23	3.82	4.21	4.50	4.82	5.76
Total Pressure	0.61	1.72	2.73	3.54	4.05	4.36	4.60	4.87	5.77
Max HP	18.04								

Sound Data		
Static Pressure	Spherical Sones	LwA
0.00	62	103
1.13	56	102
2.26	63	105
3.38	81	110

AVD 1250/403-6
1470 RPM
46° Blade Angle

Air Performance									
CFM	55837	50530	45064	39456	33871	28266	22529	16786	8095
Static Pressure	0.00	0.82	1.63	2.31	2.84	3.23	3.31	3.69	4.42
Total Pressure	1.08	1.71	2.33	2.85	3.23	3.50	3.48	3.79	4.44
Max HP	22.59								

Sound Data		
Static Pressure	Spherical Sones	LwA
0.00	65	106
0.94	60	105
1.89	63	105
2.84	114	115

Performance certified is for Installation Type B: Free inlet, ducted outlet.
 Performance ratings do not include the effects of appurtenances (accessories).
 The A-weighted sound power ratings shown have been calculated per AMCA Standard 301.
 Values shown are for (Inlet LwA) sound power levels for: Installation Type B: free inlet, ducted outlet.
 The sound ratings shown are loudness values in fan sones at 1.5 m (5 ft) in a spherical free field calculated per AMCA Standard 301.
 Values shown are for Installation Type B: free inlet spherical sone levels.

AVD DIMENSIONAL DATA

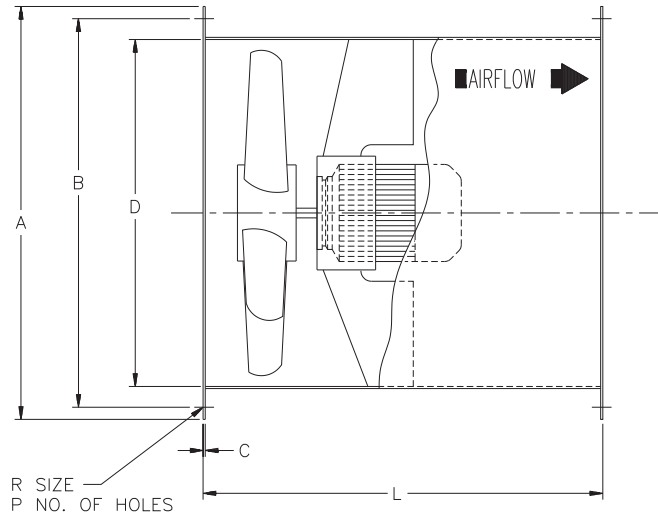

	Hub Dia. (mm)	NEMA Motor Frame	Size (Impeller Diameter)													
			AVD250		AVD315		AVD400		AVD500		AVD560		AVD630		AVD710	
			IN	mm	IN	mm	IN	mm	IN	mm	IN	mm	IN	mm	IN	mm
A	160-380	All Frame Sizes	12.20	310	15.16	385	18.90	480	23.23	590	25.59	650	28.35	720	31.50	800
B			11.02	280	13.98	355	17.72	450	22.05	560	24.41	620	27.17	690	30.31	770
C			.08	2	.08	2	.14	3	.14	3	.14	3	.14	3	.14	3
D			9.84	250	12.40	315	15.75	400	19.69	500	22.05	560	24.80	630	27.95	710
P			4.00	4	8.00	8	8.00	8	12.00	12	12.00	12	12.00	12	16.00	16
R			.38	10	.38	10	.50	12	.50	12	.50	12	.50	12	.50	12
L			14.17	360	15.75	400	20.47	520	22.05	560	24.41	620	24.41	620	28.74	730

	Hub Dia. (mm)	NEMA Motor Frame	Size (Impeller Diameter)													
			AVD800		AVD900		AVD1000		AVD1120		AVD1250		AVD1400		AVD1600	
			IN	mm	IN	mm	IN	mm	IN	mm	IN	mm	IN	mm	IN	mm
A	230-578	All Frame Sizes	35.04	890	39.37	1000	43.31	1100	48.03	1220	53.54	1360	59.45	1510	67.72	1720
B			33.86	860	38.19	970	42.13	1070	46.85	1190	51.97	1320	57.87	1470	66.14	1680
C			.14	3	.14	.75	.14	.75	.14	.75	.14	.75	.18	4	.18	4
D			31.50	800	35.43	900	39.37	1000	44.09	1120	49.21	1250	55.12	1400	62.99	1600
P			16.00	16	16.00	16	16.00	16	20.00	20	20.00	20	20.00	20	24.00	24
R			.50	12	.63	15	.63	15	.63	15	.63	15	.63	15	.75	19
L			29.53	750	33.86	860	35.43	900								
L	403	All Frame Sizes						25.59	650	29.53	750					
						33.46	850	29.53	750	25.59	650	29.53	750	33.46	850	
						33.46	850	29.53	750	29.53	750	29.53	750	33.46	850	
L	578	All Frame Sizes					35.43	900	33.46	850	33.46	850	33.46	850		
						29.53	750	25.59	650	29.53	750					
						33.46	850	29.53	750	29.53	750	29.53	750	33.46	850	
						33.46	850	35.43	900	33.46	850	33.46	850	33.46	850	
								35.43	900	37.40	950	37.40	950	37.40	950	35.43
								37.40	950	37.40	950	37.40	950	44.09	1120	
										41.73	1060	44.09	1120	44.09	1120	
												44.09	1120	44.09	1120	

Data shown on this page is for general information only and should not be used for exact installation dimensions. Refer to a submittal drawing for detailed dimensions.

Accessory dimensions are available through your local Acme representatives.

AVD FAN WEIGHTS

Hub Dia. (mm)	Weight (Less Motors)													
	AVD250		AVD315		AVD400		AVD500		AVD560		AVD630		AVD700	
	lb.	kg	lb.	kg	lb.	kg	lb.	kg	lb.	kg	lb.	kg	lb.	kg
160-380	24	11	31	14	60	27	93	42	121	55	132	60	161	73

Hub Dia. (mm)	Weight (Less Motors)													
	AVD800		AVD900		AVD1000		AVD1120		AVD1250		AVD1400		AVD1600	
	lb.	kg	lb.	kg	lb.	kg	lb.	kg	lb.	kg	lb.	kg	lb.	kg
160-380	181	82	216	98	295	134								
403			258	117	340	154	368	167	406	184	445	202		
578			337	153	423	192	441	200	593	269	725	329	807	366

Specific motor weights are available from your Acme representative.

CONVERSION TABLE				
	I-P Equivalents of Metric Units		Metric Equivalents of I-P Units	
Area	1 m ² (square meter)	= 10.764 ft ²	1 ft ² (square foot)	= .09290 m ²
Density	1 kg/m ³	= .062428 lbm/ft ³	1 lbm/ft ³	= 16.018 kg/m ³
	1 g/cm ³	= 62.428 lbm/ft ³	1 lbm/ft ³	= .016018 g/cm ³
Energy	1 J (Joule) or N-m (Newton-meter)	= .73756 ft-lb	1 ft-lb (foot pound)	= 1.3558 N-m
	1 kcal (kilo calorie)	= 3.9683 Btu	1 Btu (British thermal unit)	= 252 cal
Flow Rate (Volume)	1 m ³ /s (cubic meter per second) CMS	= 2118.9 CFM	1 CFM (Cu. ft/min)	= .00047195 m ³ /s
	1 m ³ /min (cubic meter per minute) CMM	= 35.315 CFM	1 CFM	= .02832 m ³ /min
	1 m ³ /hr (cubic meter per hour) CMH	= .58858 CFM	1 CFM	= 1.6990 m ³ /hr
	1 l/s (liter per second)	= 2.1189 CFM	1 CFM	= .47195 l/s
Force	1 N (Newton)	= .22481 lb	1 lb (pound)	= 4.4482 N
	1 kp (kilopond)	= 2.2046 lb	1 lb	= .45359 kp
Gas Constant	1 J/kg-K (Joule per kilogram Kelvin)	= .18586 ft-lb/lbm- R	1 ft-lb/lbm- R*	= 5.3803 J/kg-K
	1 m ² /s ² -K (sq. mtr per sec. sq. Kelvin)	= 5.9800 ft ² /s ² - R	1 ft ² /s ² - R**	= .16723 m ² /s ² -K
	1 cal/g- C (calorie per gram C)	= 4186.8 J/kg-K	1 Btu/lbm - R	= 1.0000 cal/g- C
			*(foot-pound per poundmass degree Rankine)	
			**(square-foot per second-square degree Rankine)	
Length	1 mm (millimeter)	= .03937 inch	1" (inch)	= 25.4 mm
	1 cm (centimeter)	= .39370 inch	1"	= 2.54 cm
	1 m (meter)	= 3.2808 ft	1 ft (foot)	= .30480 m
	1 km (kilometer)	= .62137 mi	1 mi (mile)	= 1.6093 km
Mass	1 kg (kilogram)	= 2.2046 lbm	1 lbm (pound mass)	= .45359 kg
Power	1 W (Watt)	= .00134 HP	1 hp (horsepower)	= .7457 kW
	1 kW (kilo-Watt)	= 1.3410 hp	1 hp	= 745.70 W
	1 mhp (metric horsepower)	= .98632 hp	1 hp	= 1.0139 mhp
Pressure or Stress	1 N/m ² (Newton per m ²) or Pa (Pascal)	= .0040264" wg	1" wg (inches water gauge)	= 248.66 Pa or N/m ²
	1 mm Hg or torr (mm Mercury)	= .53616" wg	1" wg	= 1.8651 mm Hg or torr
	1 kPa (kilo Pascal)	= .1450 psi	1 psi (pounds per sq. inch)	= 6894.8 Pa or N/m ²
	1 atm (atmosphere)	= 29.921" Hg	1" Hg (inch Mercury)	= 3386.4 Pa or N/m ²
	(mm Hg at 0°C or 68°F)		(inches wg at 68 F or 20 C)	
1 oz./in ²	= 1.732" wg	1"wg	= 0.5774 oz./in ²	
Temperature	For temperature intervals and rise, For temperature intervals and rise,			
	1 C (degree Celsius)	= 9/5 F	1 F (degree Fahrenheit)	= 5/9 C
	For temperature in F (Fahrenheit)	= t _c x 9/5 + 32	For temperature in C	= (t _f -32) x 5/9
Torque	1 N-m (Newton meter)	= 8.8507 lb-in.	1 lb-in. (pound inch)	= .11298 N-m
	1 N-m (Newton-meter)	= .73756 lb-ft.	1 lb-ft. (pound foot)	= 1.3558 N-m
Velocity & Speed	1 m/s	= 196.5 fpm	1 fpm (feet per minute)	= .00508 m/s
	1 km/hr (kilometer per hour)	= .62137 mph	1 mph (mile per hour)	= 1.6093 km/hr
	1 rps (revolution per second)	= .016667 rpm	1 rpm (revolution per minute)	= 60 rps
Viscosity	1 cP (Centipoise)	= .00067197 lbm/ft-s	1 lbm/ft-s (pound/foot second)	= 1488.2 cP

INLET DUCT ELBOWS

Non-uniform flow into a fan inlet is the most common cause of deficient fan performance. An elbow located at, or in close proximity to the fan inlet will not allow the air to enter the impeller uniformly. The result is less than catalogued air performance. It is strongly advised that inlet elbows be installed a minimum of three (3) diameters away from any axial or centrifugal fan inlet.

It is strongly advised that inlet elbows be installed a minimum of three (3) diameters away from any axial or centrifugal fan inlet.

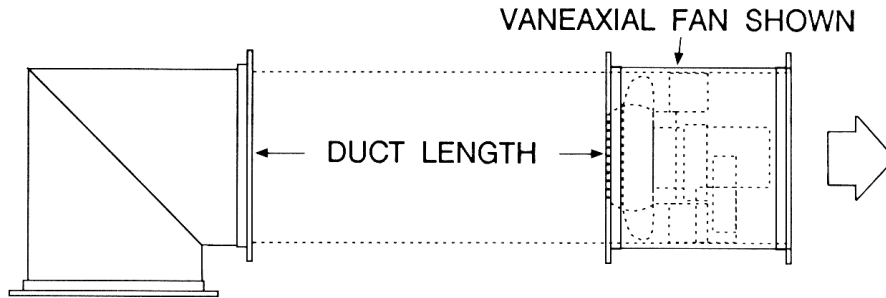

OUTLET DUCT ELBOWS

Values for pressure losses through elbows, which are published in handbooks and textbooks, are based upon a uniform velocity profile approaching the elbow. Any non-uniformity in the velocity profile ahead of the elbow will result in a pressure loss greater than the published value.

The velocity profile at the outlet of a fan is not uniform and an elbow located at or near the fan outlet will, therefore, develop a pressure loss greater than its "handbook" value.

The amount of this increased loss will depend upon the location and orientation of the elbow relative to the fan outlet. In some cases the effect of the elbow will be to further distort the outlet velocity profile of the fan. This will increase the losses and may result in such uneven flow in the duct that branch takeoffs near the elbow will not deliver their designed air flow.

Wherever possible a length of straight duct should be installed at the fan outlet to permit diffusion and development of a uniform flow profile before an elbow is inserted in the duct. If an elbow must be located near the fan outlet then it should have a minimum radius to duct diameter ratio of 1.5.

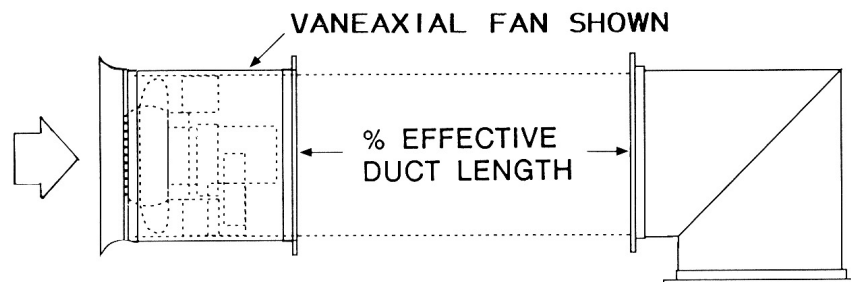

Reprinted from AMCA Publication 201-90, FANS AND SYSTEMS, with the express written permission from the Air Movement and Control Association International, Inc., 30 West University Drive, Arlington Heights, IL 60004-1893.

Further information on axials and centrifugal fans is provided in the above mentioned publication.

CENTRIFUGAL EXHAUSTERS



CEILING AND CABINET EXHAUSTERS



IN-LINE CENTRIFUGAL FANS



IN-LINE AXIAL FANS



PROPELLER ROOF FANS



PROPELLER WALL FANS



UTILITY BLOWERS



SUPPLY AIR FANS



ROOF VENTS

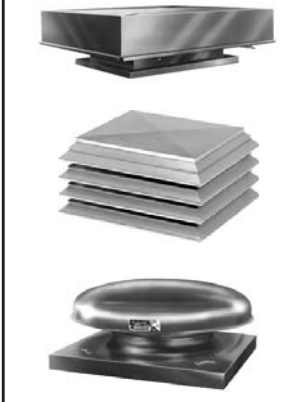

PLENUM FANS

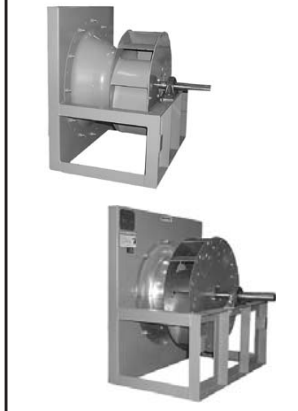

BACKWARD INCLINED/AIRFOIL CENTRIFUGAL FANS



LIMITED WARRANTY Acme Engineering and Manufacturing Corporation extends this limited warranty to the original purchaser and warrants that products described herein shall be free from original defects in workmanship and materials for two years from date of shipment (except for Acme's exclusive duplex split pillow block bearings and shaft 5 years from shipment, belts one year from shipment, and polyethylene tubing at 90 days from shipping), provided same have been properly handled, stored, installed, serviced, maintained and operated. Refer to Form MS149 for complete limited warranty terms and conditions. This form is available to anyone at www.acmefan.com. The Company's warranty is in lieu of all other warranties, express or implied, arising by law or otherwise, including without limitation the implied warranties of merchantability and fitness for a particular purpose, which are hereby expressly disclaimed and waived.

Acme products are designed and manufactured to provide reliable performance but they are not guaranteed to be 100% free of defects. Even reliable products will experience occasional failures and this possibility should be recognized by the Purchaser and End User. If these products are used in a life support ventilation system where failure could result in loss or injury, the Purchaser and End User should provide adequate back-up ventilation, supplementary natural ventilation or failure alarm system, or acknowledge willingness to accept the risk of such loss or injury.

WARNING DO NOT use in HAZARDOUS ENVIRONMENTS where fan's electrical system could provide ignition to combustible or flammable materials unless unit is specifically built for hazardous environments. Comply with all local and national safety codes including the National Electrical Code (NEC) and National Fire Protection Act (NFPA). Guards

must be installed when fan is within reach of personnel or within eight (8) feet (2.5 m) of working level or when deemed advisable for safety.

DISCLAIMER The Company has made a diligent effort to illustrate and describe the products in this literature accurately; however, such illustrations and descriptions are for the sole purpose of identification, and do not express or imply a warranty that the products are merchantable, or fit for a particular purpose.

INDEMNITY Purchaser acknowledges various warnings by the Company regarding the products and its installation and use. If the Company incurs any claims, lawsuits, settlements, or expenses (including attorney fees) for any loss, injury, death or property damage including, but not limited to, claims arising out of the Purchaser's or any end user's installation or use of the products, the Purchaser shall indemnify and hold the Company harmless.



ACME ENGINEERING & MANUFACTURING CORP.

P.O. Box 978, Muskogee, Oklahoma 74402
 Telephone: 918-682-7791 Fax: 918-682-0134
www.acmefan.com e-mail: acmefan@acmefan.com

Member Air Movement and Control Association International, Inc.