

# Low Pressure Axial Smoke-exhaust Fan Driven Directly

with Cast Aluminum Airfoil Propellers



amca  
WORLDWIDE  
CERTIFIED  
RATINGS

SOUND  
AND  
AIR  
PERFORMANCE

FEG  
FAN EFFICIENCY  
GRADE CERTIFIED

AIR  
MOVEMENT  
AND CONTROL  
ASSOCIATION  
INTERNATIONAL, INC.

www.amca.org

超越極限 · 誰與爭鋒

 **FLOWTECH**  
鳴鼎實業股份有限公司

## Axial Smoke-exhaust Fan Driven Directly with Cast Aluminum Airfoil Propellers



FLOWTECH Co., Ltd. certifies that the series LASD shown herein (page 18-89) are licensed to bear the AMCA Seal. The ratings shown are based on tests and procedures performed in accordance with AMCA Publication 211 and AMCA Publication 311 and comply with the requirements of the AMCA Certified Ratings Program.

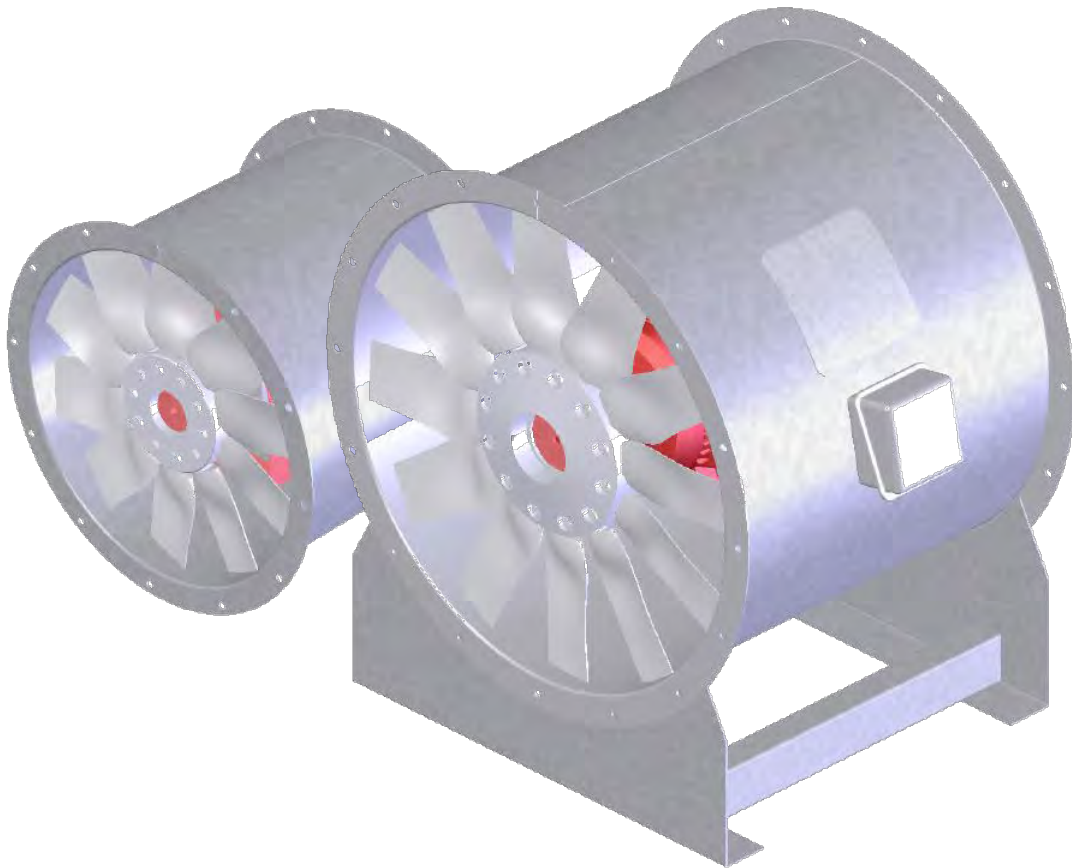

# Contents

LASD	Contents	Page
	<b>Technical description</b>	4-17
	Fan code	4
	Types and duties	5
	Casing	5
	Impellers	5
	Motors	6
	Forms of running Ancillaries	6
	Accessories	6
	Specify the fan	7
	Ordering the fan	7
	Useful information	7
	Fan installation	8
	Example fan selection	8
	Acoustic and noise control	10-13
	Fan Laws	13-14
	Fan Performance	14-17
	Performance curves	18-71
	LASD-560	18
	LASD-630	24
	LASD-710	40
	LASD-800	48
	LASD-900	54
	LASD-1000	60
	LASD-1250	66
	Sound Data	72-94
	LASD-560	72
	LASD-630	74
	LASD-710	82
	LASD-800	86
	LASD-900	88
	LASD-1000	90
	LASD-1250	92
	Dimensions + Accessories	94-96

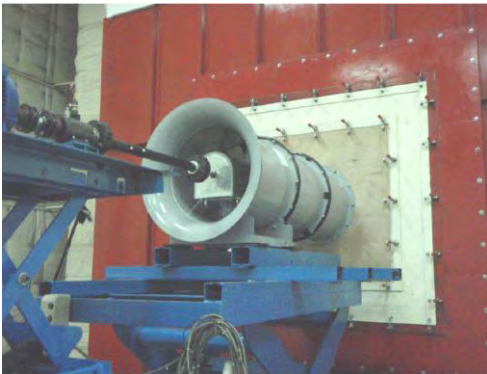
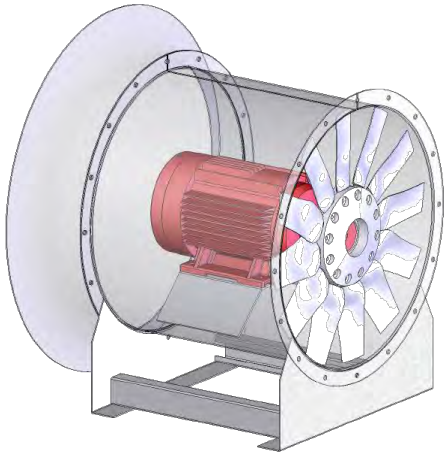

## Technical description

### Fan code

FOR EXAMPLE LASD-560-200-5/10°-3.7-2-6

LASD - 560 - 200 - 5 / 10° - 3.7 - 2 - 6

Frequency of motor  
(5:50Hz 6:60Hz)

Number of poles of motor

Power of motor, Unit: kW

Number of Blades / Blade Pitch Angle[°]

Hub Diameter

Normal Fan Diameter, Unit: mm

1. LASD series

Low pressure Axial Smoke-exhaust fan driven Directly

2. AD series

Axial fan driven Directly

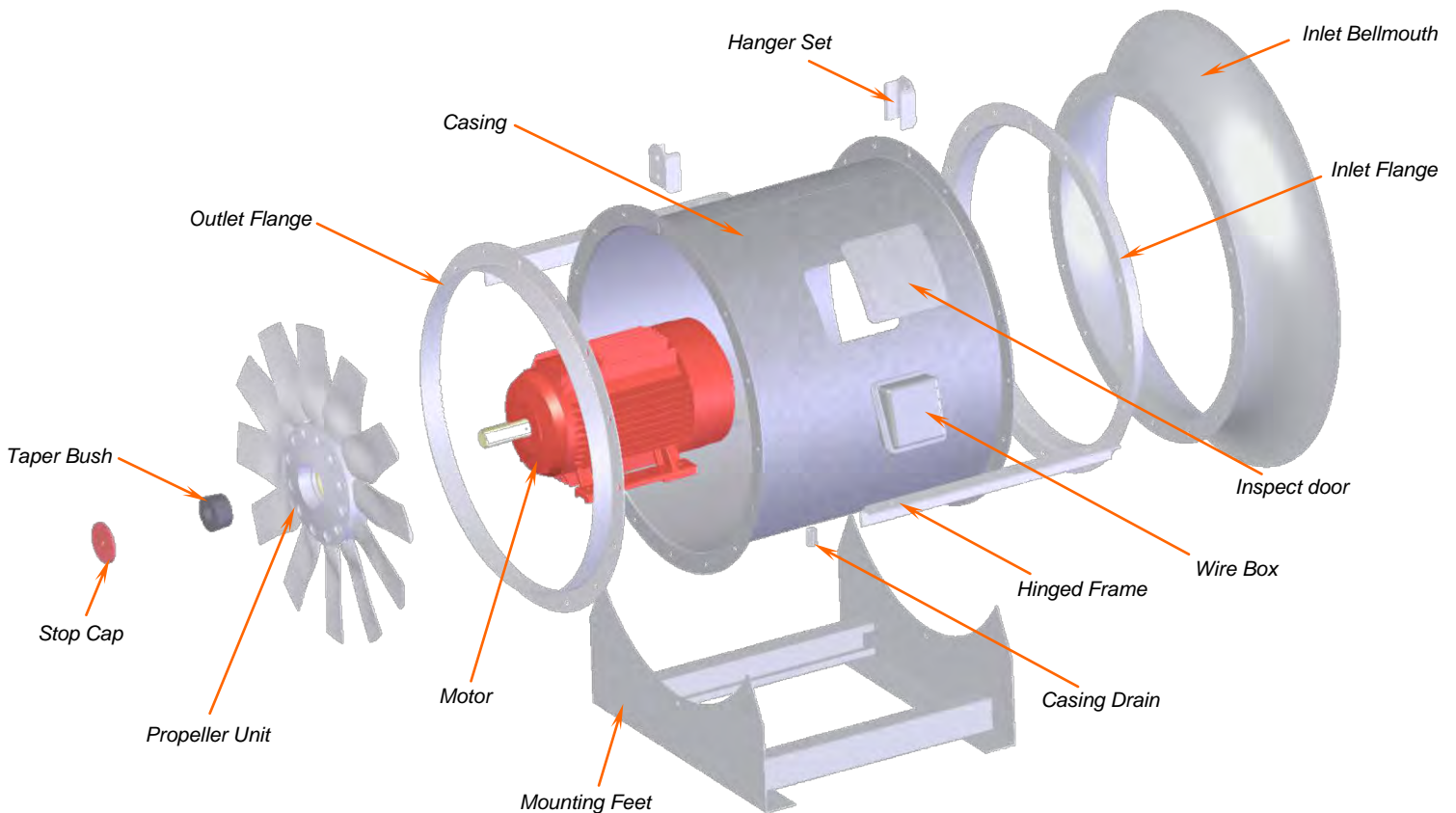
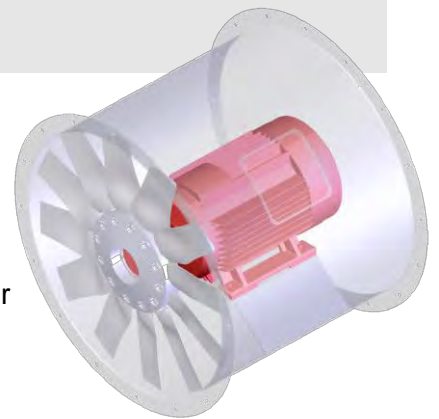

Fan layout drawing



## Types and Duties

**Flowtech**-Axial flow Smoke-Exhaust fans are specially manufactured for all applications and mounting positions in case sizes 560 up to 1250 mm diameter. The performance range is from 500 up to 2,000 m<sup>3</sup>/min on air volume, at total pressure up to 1,800 Pa. Higher pressures are possible on multi-stage versions, contra-rotating. Air performance according to AMCA 210 standard, shown is for test installation type B, free inlet, ducted outlet.

## Casing

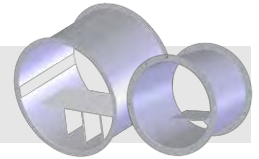

### Version: L (light version)

Casings are spun of sheet galvanized steel with integral inlet flanges on both ends, mounting hole drilled in accordance to DIN 24154, R 2. The strengthen structure is order to pad-mounted motors, foot-motors or flange-motors. It is suitable for duct or plenum type installation. This version is for all applications including smoke-extract and normal conditions in the HVAC-market.

### Version 2: H (heavy version)

Fan case and motor mounting made of hot-rolled steel, after welding that all steel parts are hot dip galvanized manufacturing. This version is for higher demands, for heavy industry or for high performances. Flanges on both ends, drilled in accordance to DIN 24154, R2 are integrated. On this type external terminal boxes are fitted as standard. If motors are with lubrication, tubes and grease-nipples are fitted outside fan case.

## Propeller

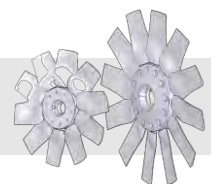

The **Flowtech**-propellers, hubs and blades are made of cast aluminum alloy, the aero-dynamical profile guarantees high efficiency and low noise. The blades are with adjustable pitch angle to optimum the duty point. The solidity varies for a wider range of performance. All rotating aluminum components are X-ray examined to ensure quality and reliability. All propellers are statically and dynamically balanced to ISO 1940 and AMCA 204 balance quality grade level-G2.5.

## Motors



**Flowtech** uses as standard closed squirrel cage motors with pad-mounting and airstream rated to IEC 34, if required also in accordance to EPACT. The standard motors have Class H and enclosure IP 54. Continuous operating ranges from -40 °C to +40 °C, other operating conditions on demand. Multi speed versions with 2 or 3 speeds, TAB- or DUAL-wounded are also available. The motor bearings have L 10 (or L50) life design. All motors are can be manufactured to correspond to F200, F300 or F400 requirements for smoke-extract application.

## Forms of running

**Flowtech**-Axial flow fans are available for all forms of running. The chart information shows all standard forms of running, please indicate when ordering. Standard form of running "S". Form of running is especially relevant when weather proof motors are required.

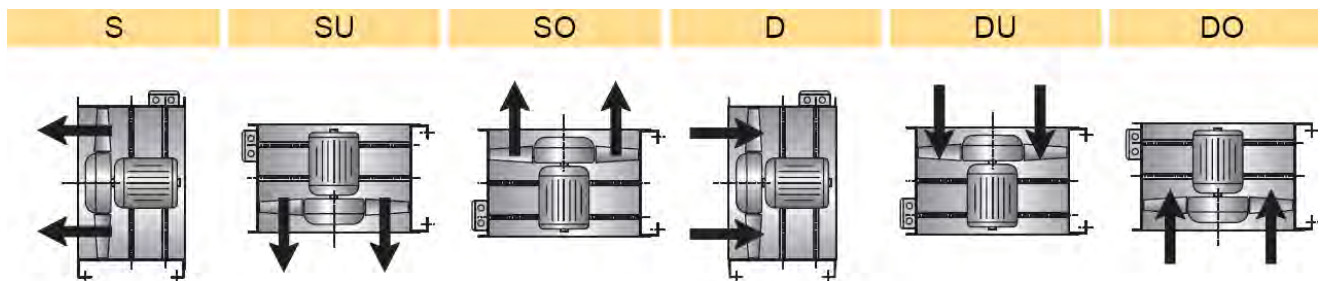

Arrows indicating correct rotating and direction of airflow are mounted on the outside of the fan case.

## Ancillaries

**Flowtech** offers a wide range of ancillaries, e.g.:

- \* Propeller or motor side guard
- \* Mounting feet for both horizontal or vertical operation
- \* Matching flanges
- \* Complete flex. connectors
- \* Bellmouth inlets
- \* Air operated dampers

- \* Anti-vibration mounts
- \* Silencers with or without pod
- \* Anti-spark-track for flame proof
- \* Inverters

## Specify the fan

Having chosen the fan most suitable for your individual application: please specify as follows:

- (1) Manufacturer **Flowtech**, light or heavy version.
- (2) Exact details on motor data like power supply and cycles and specifications on temperature, flame proof, multi-speeds, extra enclosure and overheat protection.
- (3) The impeller manufactured in cast aluminum alloy with high efficiency blade profile and adjustable pitch angle.
- (4) The case in light version made of galvanized sheet steel or heavy version with hot dip galvanized finish.
- (5) All necessary ancillaries are to be specified.

## Ordering the fan

After selection of the fan best for your needs please order as follows:

- (1) Fan type, casing version and running form
- (2) Fan code and type: see below
- (3) Quantity required
- (4) Duty required at standard air and temperature, air volume in m<sup>3</sup>/s at static pressure in Pa.
- (5) Motor power rating in kW
- (6) Electrical supply
- (7) Ancillaries required

## Useful information

### Fan selection

Please select fans within the curve. Do not select above curve end, fan will work in stall and will be damaged. For a non-overloading selection you can select motor on the peak-kW from each pitch angle which marks and covers the maximum on absorbed power.

## Fan installation

Installation recommendations are as follows:

- Fans with free inlet and outlet should be installed with 1,5 x fan diameter distance on extract and supply side to next equipment. Fans should have a bellmouth on the air entry to get a smooth airstream. High performance fans will work at higher efficiencies and save energy if diffusers are mounted on the outlet.
- When installing fans into systems and to other equipments (bends by 90 degree., filters, silencers etc) correct bend radius and distance are to be considered to avoid losses. Flexible connectors are to be installed smooth. By not following advices you will lose performance. (see pictures below)

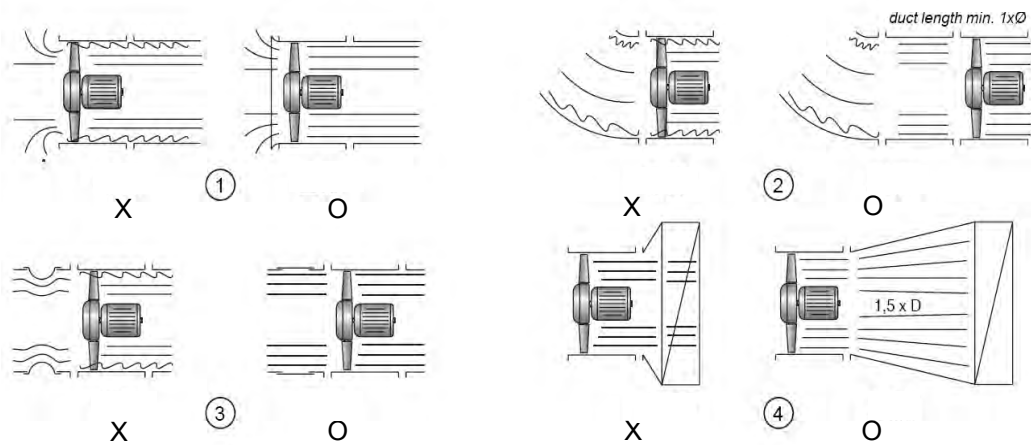

## Example fan selection

Required duty point by customer

\* Volume flow : 6 m<sup>3</sup>/s

\* static pressure : 60Pa

\* Fan speed : 1440 [RPM] ( 4 Pole )

### How to use:

After having chosen right fan performance curve please draw volume flow and pressure.

In the cross you will find the following fan data:

\* motor speed or number of poles 1440 [RPM] - 4-pole

\* pitch angle : 16 degrees



# Performance Curve

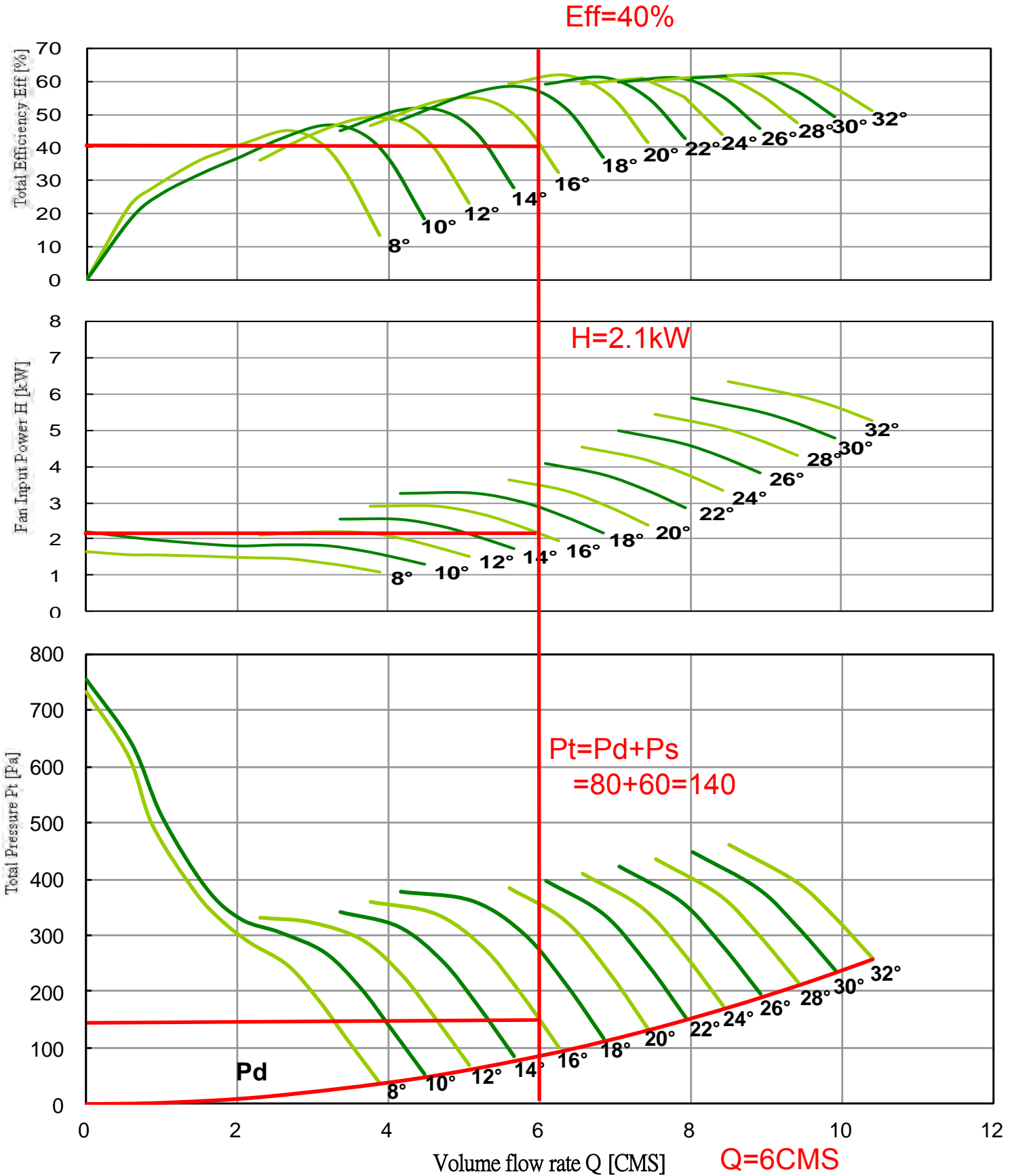

## Choose motor power

After peak-absorbed power see table chart: 5 kW

Peak power is the max power over the whole pitch angle in the worst case.

How to get the required noise level, see page 90.

## Acoustic and noise control

### General

Noise produced by axial flow fans is basically in a high frequency level. The sound power depends on careful selection of the fan regarding duty, efficiency, characteristics and above all quality of installation. There is a strong correlation between sound power and aerodynamic loss of the fan. Generally speaking, sound power of fans is a function of air volume and total pressure. This will be confirmed by the following rough calculation formula:

$$L_{WG} [dB] = L_{WS} + 10 \log(\dot{V} [m^3/s]) + 20 \log(\Delta p_{tot} [Pa]) \pm 5$$

where by:

$L_{WG}$  =total sound power

$L_{WS}$  =specific sound power by the speed (see fig.1)

Fig 1.

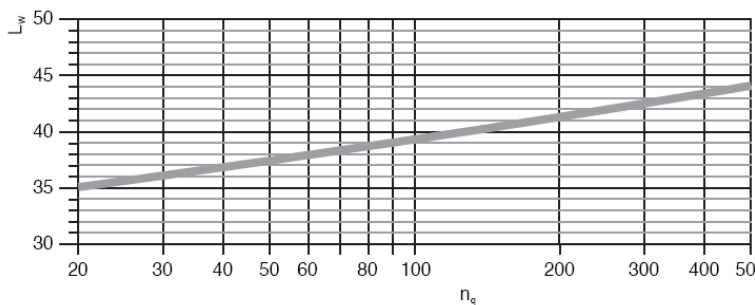

$$n_q = n [\text{min}^{-1}] \cdot \frac{\sqrt{\dot{V} [\text{m}^3/\text{s}]}}{\left( \frac{\Delta p_t [\text{Pa}]}{\rho_m [\text{kg}/\text{m}^3] \cdot 9.81} \right)^{3/4}}$$

## Sound power levels

This is the amount of power which a source gives off as sound. Sound power levels are expressed in decibels with a reference level of 1 picoWatt. The sound power level of a source remains the same regardless the environment and the distance to the listener.

## Sound pressure levels

These are pressure fluctuations radiated by a source expressed in decibels with a reference level of 20 µPa. The sound pressure level varies according to the distance of source to the listener and its environment.

$$Nr = 10\log(4 \pi \times r^2)$$

Sound distance ;

r [m]

Noise reduction ;

Nr [dB]

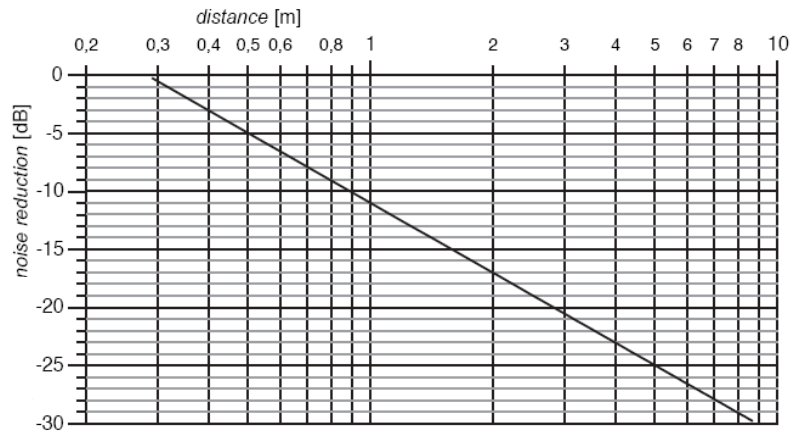

## Frequencies

Sound is split into different frequencies. Frequencies of human hearing ranges from about 20 cycles per second (Hz) to 20000 cycles per second (Hz). For practical purposes FLOWTECH publishes noise data in eight octave bands with the centre frequencies of 63, 125, 250, 500, 1000, 2000, 4000 and 8000 Hz.

## „A“ weighted sound pressure levels (dBA)

The ear is more sensitive to sound in some frequencies than in others. The „A“-weighting is an attempt to reflect this natural attention of sound. The „A“-weighting is a set of figures which are applied to the sound pressure levels. The levels in each of the octave band are added logarithmically to give a single figure. „A“-weighting will be over octave band as follows:



Frequency[Hz]	63	125	250	500	1000	2000	4000	8000
A-weighting[dB]	-26	-16	-9	-3	0	+1	+1	-1

## Example

Customer requires the dB(A) level at 3 m distance from a 800 diameter. fan, 1760 1/min, 12 blades, 20 degree.

pitch angle, duty 6 m³/s at 500 Pa (static).

The sound data for the operating points inside these boundaries may be determined using interpolation.

Example to Ps comparison with 63Hz;  $\frac{500 - 346}{517 - 346} = \frac{L_{W_{63Hz}} - 92}{94 - 92} \Rightarrow L_{W_{63Hz}} = 92 + \frac{2 \times 154}{171} = 93.8 \cong 94 \text{ [dB]}$

The same method to calculate and fill in each octave band decibel data as following:

Model No.	RPM	Ps	Sound Power re 10 <sup>-12</sup> Watts Octave Band [Hz]								L <sub>W</sub> A
			63	125	250	500	1000	2000	4000	8000	
LASD-800-12/20°-7.5-4	1760	346	92	97	97	98	94	91	87	83	100
LASD-800-12/20°-7.5-4	1760	517	94	99	99	102	101	97	92	85	105

LASD-800-12/20°-7.5-4	1760	500	94	99	99	102	100	96	92	85	104.2
-----------------------	------	-----	----	----	----	-----	-----	----	----	----	-------

63Hz;  $\frac{500 - 346}{517 - 346} = \frac{L_{W_{63Hz}} - 92}{94 - 92} \Rightarrow L_{W_{63Hz}} = 92 + \frac{2 \times 154}{171} = 93.8 \cong 94 \text{ [dB]}$

Frequency [Hz]	63	125	250	500	1000	2000	4000	8000
sound power level	94	99	99	102	100	96	92	85
Reduction for 3 m distance (fig. 2)	-20	-20	-20	-20	-20	-20	-20	-20
Apply „A“ as chart 3	-26	-16	-9	-3	0	1	1	-1

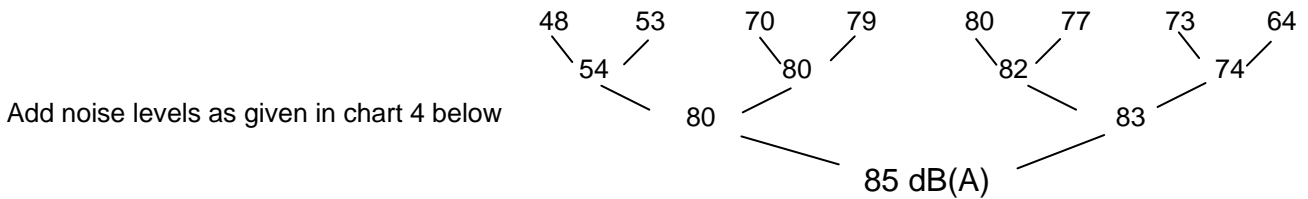

Chart (4)	Addition of sound level	
	Difference between two sound levels [dB]	Add to the higher level [dB]
	0-1	3
	2-3	2
	4-9	1
	≥10	0

$$L_{\Sigma} = 10 \cdot \log(10^{0.1L_1} + 10^{0.1L_2} + \dots + 10^{0.1L_n})$$

whereby:  
 L1= sound level of a source 1  
 L<sub>Σ</sub>= resulted level



## Noise of several sources, equivalent in characteristic and level

$$L_{\Sigma} = L_1 + 10 \cdot \log(Z)$$

whereby:

Z= number of sources

L1= sound level of a single source

L<sub>Σ</sub>= resulted level

Please note:

Here are some usefully information and fan laws:

## Fan Laws

• Volume flow  $\approx$  rotational speed  
**Speed change - constant size**

\* Pressure (all)  $\approx$  (rotational speed)<sup>2</sup>

$$\frac{\dot{Q}_2}{\dot{Q}_1} = \frac{N_2}{N_1}$$

\* Pressure (all)  $\approx$  (rotational speed)<sup>2</sup>

$$\frac{\Delta P_a}{\Delta P_b} = \left(\frac{N_1}{N_2}\right)^2 = \left(\frac{\dot{Q}_1}{\dot{Q}_2}\right)^2$$

\* Power absorbed  $\approx$  (rotational speed)<sup>3</sup>

$$\frac{P_1}{P_2} = \left(\frac{N_1}{N_2}\right)^3 = \left(\frac{\dot{Q}_1}{\dot{Q}_2}\right)^3$$

Speed change - constant size  
**(for geometrically similar fans only)**

\* Volume flow  $\approx$  (impeller Diameter)<sup>3</sup>

$$\frac{\dot{Q}_2}{\dot{Q}_1} = \left(\frac{D_2}{D_1}\right)^3$$

\* Pressure  $\approx$  (impeller Diameter)<sup>2</sup>

$$\frac{\Delta P_1}{\Delta P_2} = \left(\frac{D_1}{D_2}\right)^2$$

\* Power absorbed  $\approx$  (impeller Diameter)<sup>5</sup>

$$\frac{P_1}{P_2} = \left(\frac{D_1}{D_2}\right)^5$$

### Density change - constant speed- constant size

\* Volume flow no change:

$$\dot{V} = \text{constant}$$

\* Pressure  $\approx$  Density

$$\frac{\Delta P_1}{\Delta P_2} = \frac{\rho_1}{\rho_2} = \frac{T_2}{T_1}$$

whereby:

T= Kelvin Temperature[K]

\* Power absorbed  $\approx$  Density

$$P_L [kW] = \frac{\dot{V} [m^3 / s] \times \Delta P_t [Pa]}{\eta [\%] \times 10}$$

### Pressure :

\* Dynamic Pressure [Pa]

$$P_d = \frac{\rho}{2} \cdot V^2$$

whereby:

$\rho$ = air density in [kg/m<sup>3</sup>]

V = air velocity in [m/s]

\* Total pressure

$$P_t = P_s + P_d$$

\* Absorbed power - calculation in duty point

$$\frac{P_1}{P_2} = \frac{\rho_1}{\rho_2} = \frac{T_2}{T_1}$$

## Fan Performance

### Statement of Fan Performance

Air and Sound performance of LASD series are based on test conducts in according with AMCA Standard 210. and performance changes with two factors as following:

- The air duct near to the fan were blocked or suddenly change the outline of ductwork.  
In general, the air flow smoothly through the fan in a perfect design condition, and performance will appear like the result that expect.
- Change of the component within the fan , such as the change of the model of the fan, or even there is sizable most tip clearance.

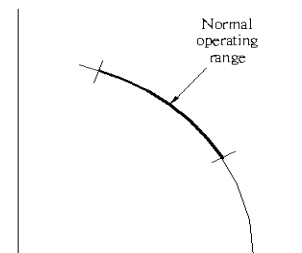

The influence of the following general effect that the choice of the fan must also be considered, in order to reach the working order on the proper choice blade pitch angle.

### Fan Type

The installation way of LASD series main duct has type-A fan and corresponding type-B. Its difference of performance is mainly due to the fan outlet and inlet, in actual use install duct or horn inlet.

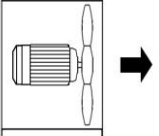
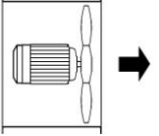
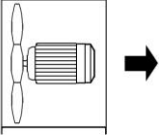
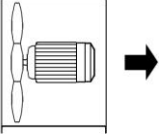
Type	Installation mode	Performance Change	Noise Change
A	 B&D	Refer to Performance Curve	Refer to Noise Tables
A	 A&C	qv 1.02 Compare to mode D PsF 1.04 Performance Curve	Refer to Noise Tables
B	 B&D	Refer to Performance Curve	+ 2 ~ 3 dB
B	 A&C	Refer to Performance Curve	+ 2 ~ 3 dB

*Fan performance with Type A and Installation mode B are licensed by AMCA International only.*

## Propeller Material

Propeller Hubs and blades are made with cast aluminum and airfoil blades ensure efficient performance. Fan have several blades mode and blade pitch angle can be adjusted statically to ensure best operating condition.

## Tip clearance

Fan performance curve and noise data are based on tip clearance /Impeller diameter in 0.25%。 If the tip clearance get bigger then performance curve must be adjusted as following.

Tip clearance/Impeller dia.	: 0.5%	qv*1.01, PsF * 1.02
Tip clearance/Impeller dia	: 0.75%	qv*1.04, PsF * 1.08
Tip clearance/Impeller dia	: 1.0%	qv*1.06, PsF * 1.12

*Fan performance calculates with this correction factors for tip clearance are not licensed by AMCA International.*

## Pressure Drop of Compound Fan



For special conditions, for example: using two fan, one fan operating and other standby. pressure drop of compound fan are in relation to blade pitch angle.

Blade Pitch Angle	K factor
8° ~20°	6.0
20° ~30°	3.0
30° ~20°	2.0

Pressure Drop = K \* Pdf

Fan performance calculates with this correction factors are not licensed by AMCA International.

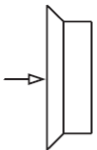
### Pressure Drop of standard Accessories

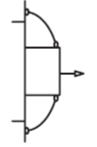
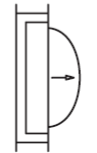
bellmouth inlets		K factor 0.20- A-mode 0.38- B-mode
guard		0.75
Motor guard		0.4
Damper		0.3~0.4

Fan performance calculates with this correction factors "K" are not licensed by AMCA International.

### Other Devices

Another installation mode does not mention here also can be apply to LASD series fan. General guideline are as following.

Fan Installation mode	Pressure effect	Noise effect
Single fan with guide vane	1.25	+1 dB
Twin fans with guide vane	2.00	+3 dB
Reversible Twin fans	2.4	+8 10 dB
Separable flow	0.7	+2 dB

Fan performance calculates with this correction factors are not licensed by AMCA International.

When select the operation pint must consider the pressure drop effect as described and adjust the performance curve.



## Installation Guidelines for Ductwork of Axial Fan

Please follow Installation Guidelines with Ductwork to maximize the air delivery to your ventilation system.

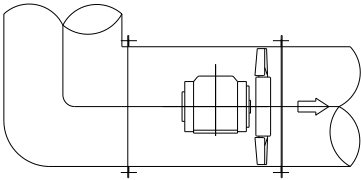
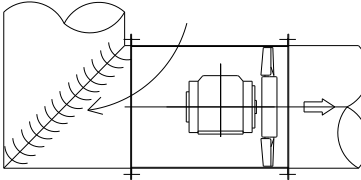
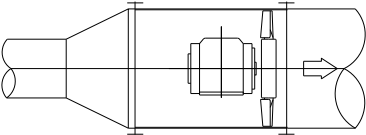
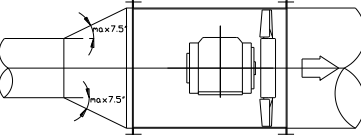
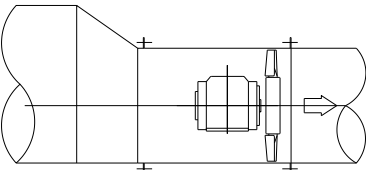
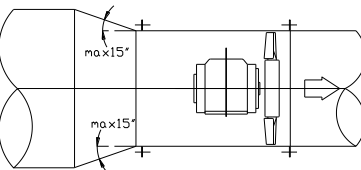
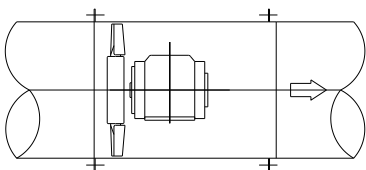
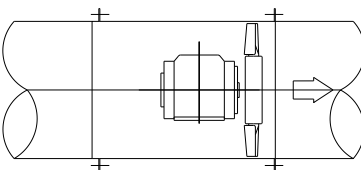
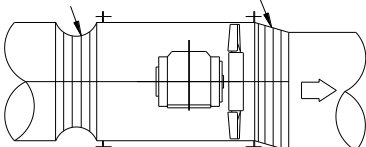
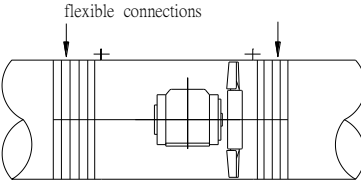
X	O
 <p>Upstream radius elbow creates imbalance at inlet</p>	 <p>Square inlet elbow with extended trailing edge Vaner delivers less airflow to fan turbulent inlet.</p>
 <p>Abrupt inlet transition Causes turbulence</p>	 <p>Gradual (1:7) expansion of Inlet duct avoids impeller turbulence</p>
 <p>Asymmetrical transition creates imbalance with Minimizes turbulence and noise</p>	 <p>Symmetrical transition balances load on fan, minimizes turbulence and noise.</p>
 <p>Motor upstream of impeller increase turbulence and noise</p>	 <p>Motor downstream from impeller.</p>
 <p>Slack or offset flexible connection causes turbulent air flow.</p>	 <p>flexible connections Taut in-line flexible connections provide optional vibration isolation without creating turbulence.</p>

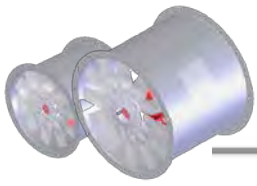

# Axial Fan Driven Directly



LASD-560-200-5 **50Hz** Performance curves



**FEG 60**

Fan Speed ; N = 960 [RPM] Outlet Area ; A = 0.2463 [m<sup>2</sup>]

$\rho = 1.2\text{kg/m}^3$

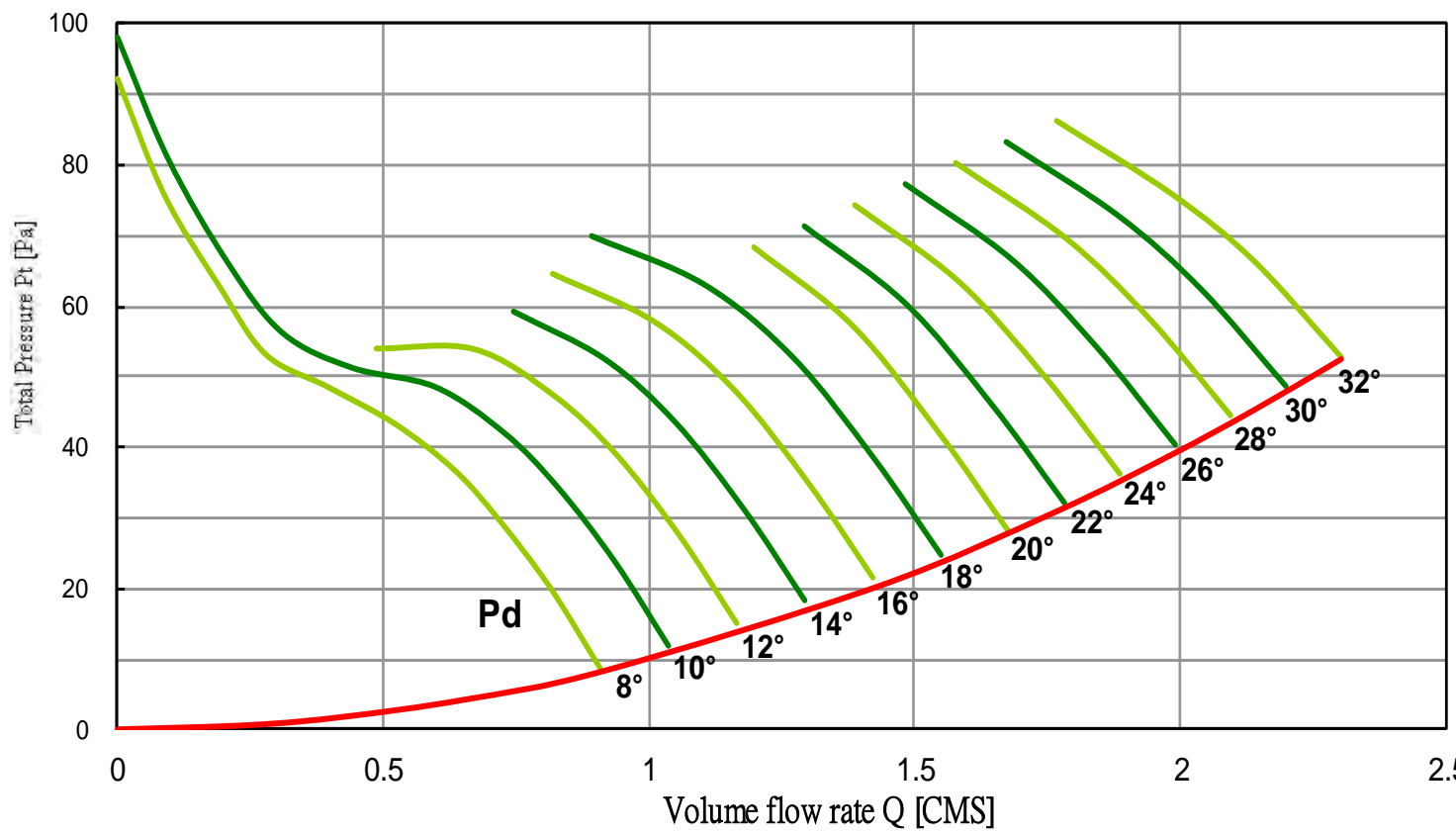
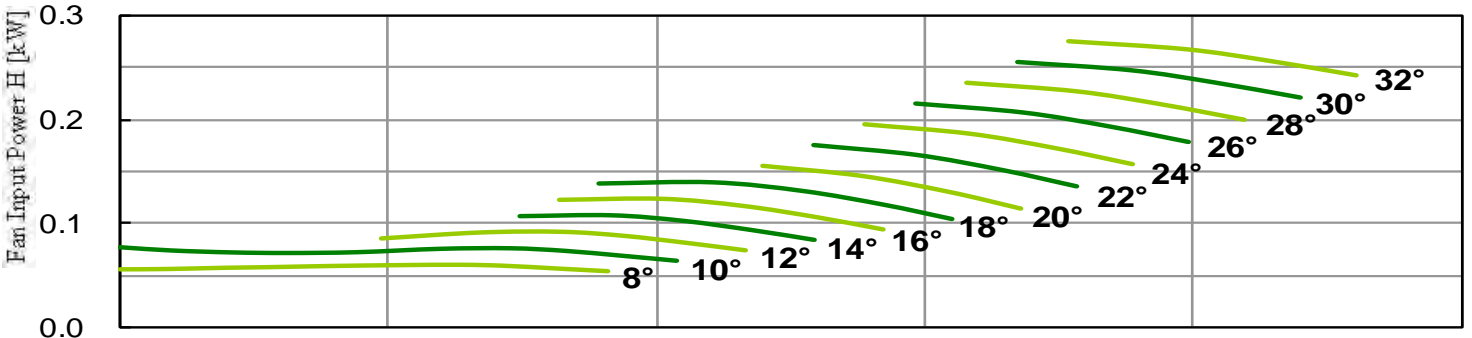
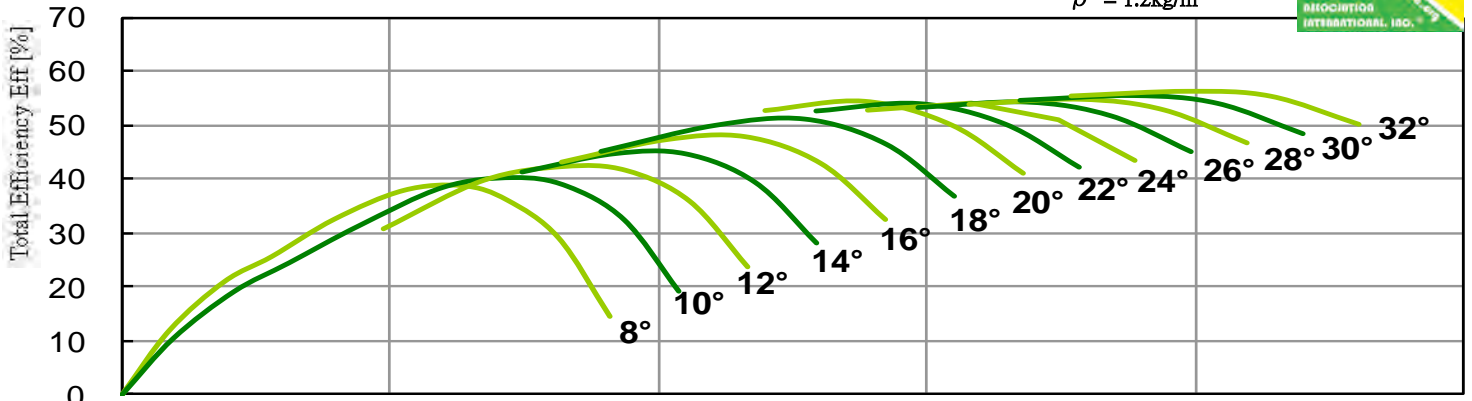

Performance certified is for installation type B : free inlet, ducted outlet. Performance ratings do not include the effects of appurtenances (accessories).

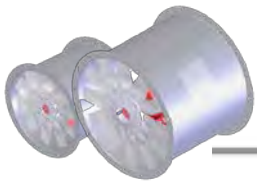

# Axial Fan Driven Directly



LASD-560-200-5 **50Hz** Performance curves



**FEG 60**

Fan Speed ; N = 1440 [RPM] Outlet Area ; A = 0.2463 [m<sup>2</sup>]

$\rho = 1.2\text{kg/m}^3$

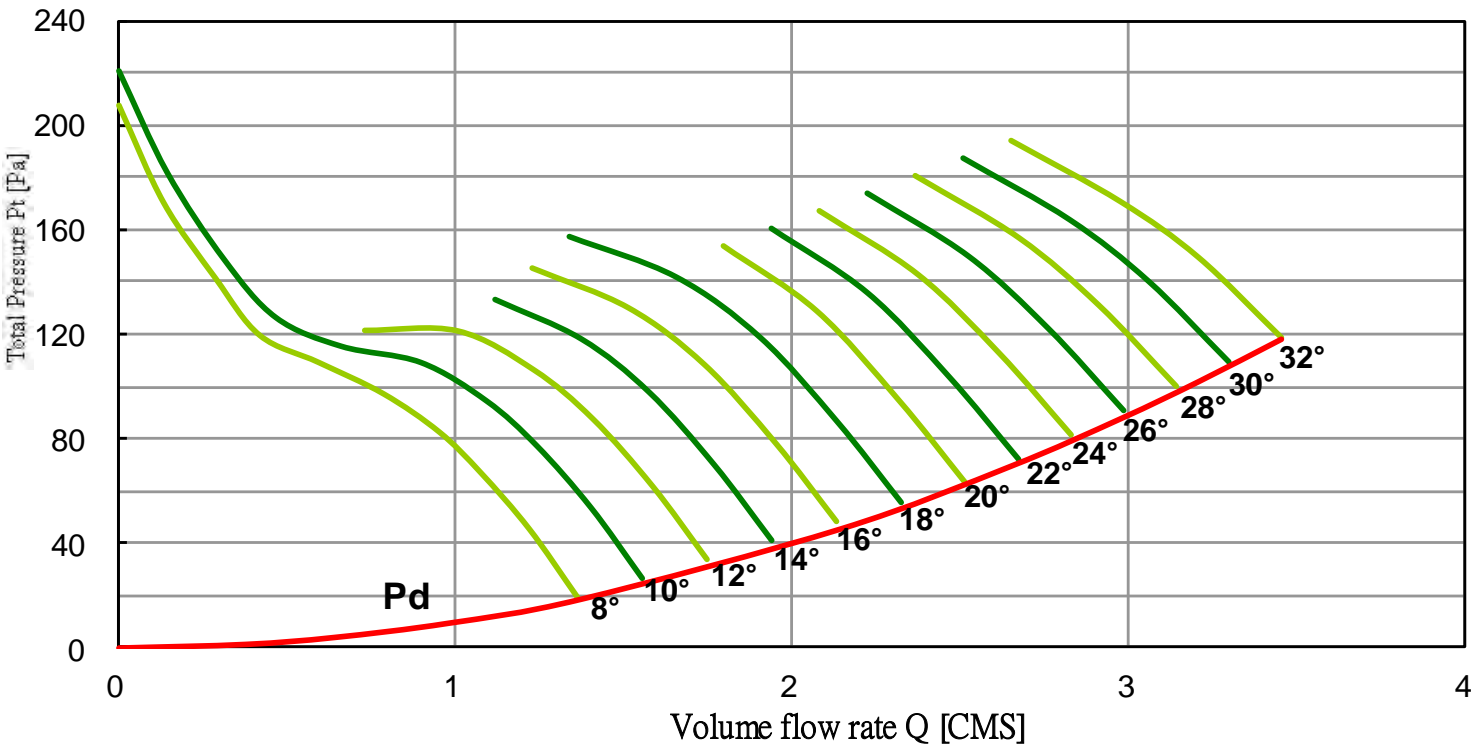
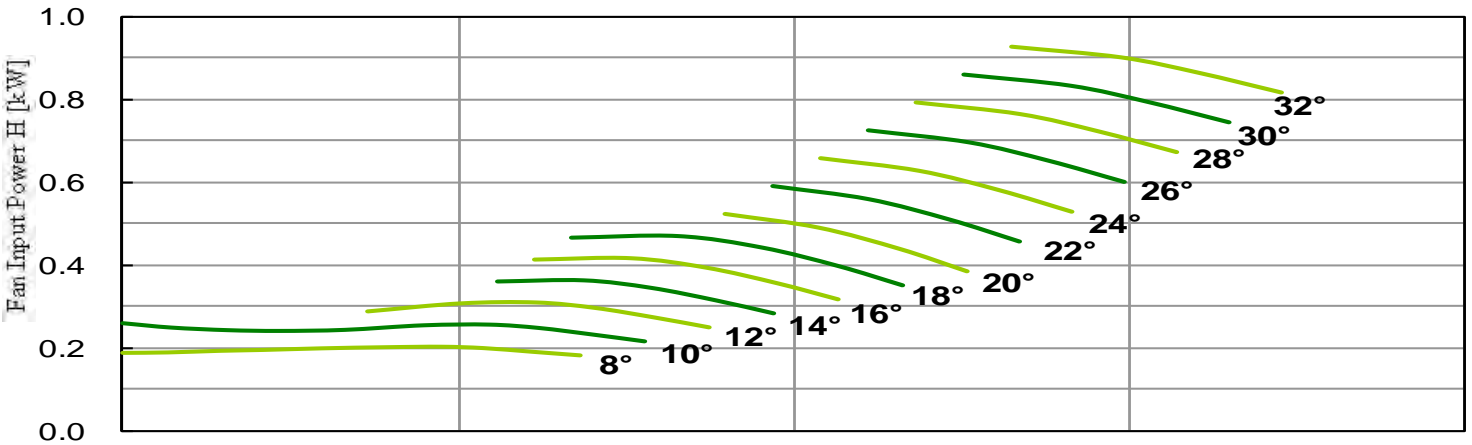
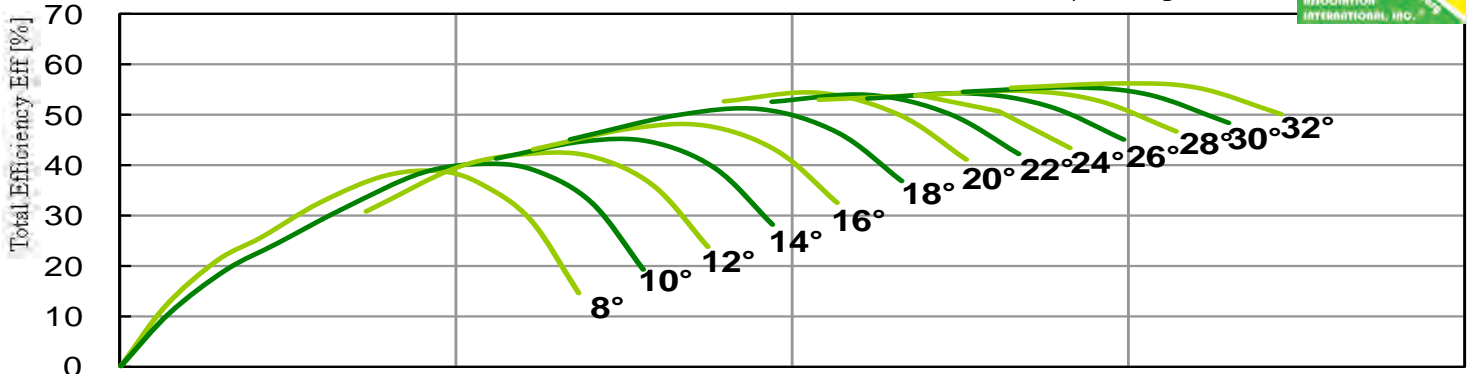

Performance certified is for installation type B: free inlet, ducted outlet. Performance ratings do not include the effects of appurtenances (accessories).

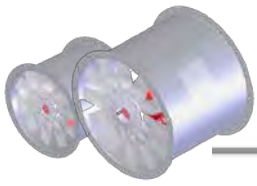

# Axial Fan Driven Directly



LASD-560-200-5 **50Hz** Performance curves



**FEG 60**

Fan Speed ;  $N = 2850$  [RPM]    Outlet Area ;  $A = 0.2463$  [m<sup>2</sup>]

$\rho = 1.2$ kg/m<sup>3</sup>

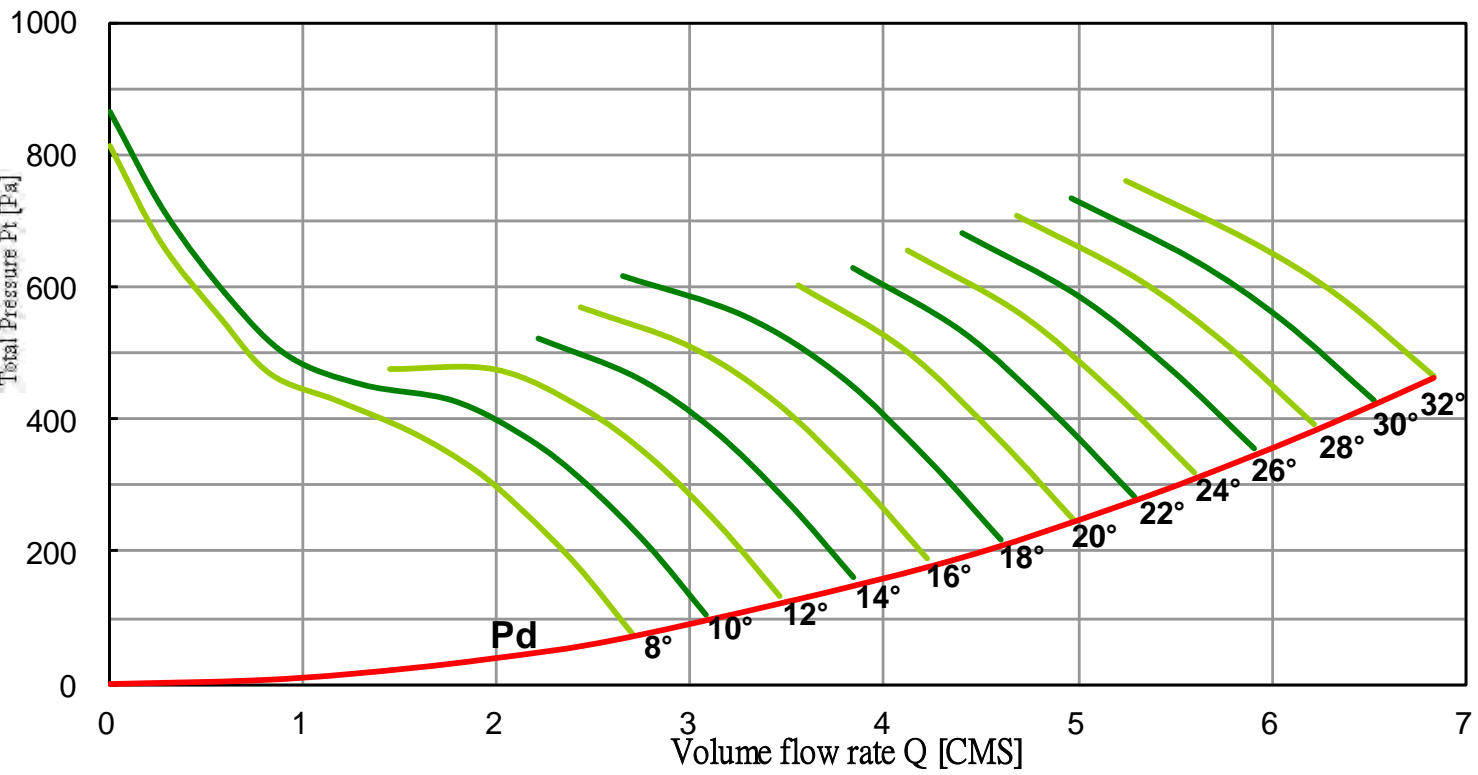
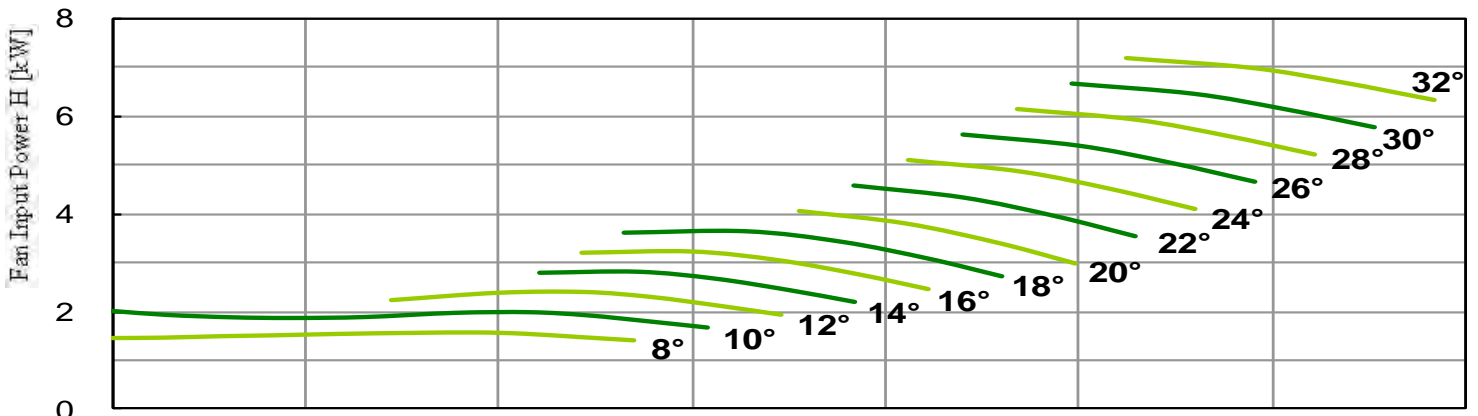
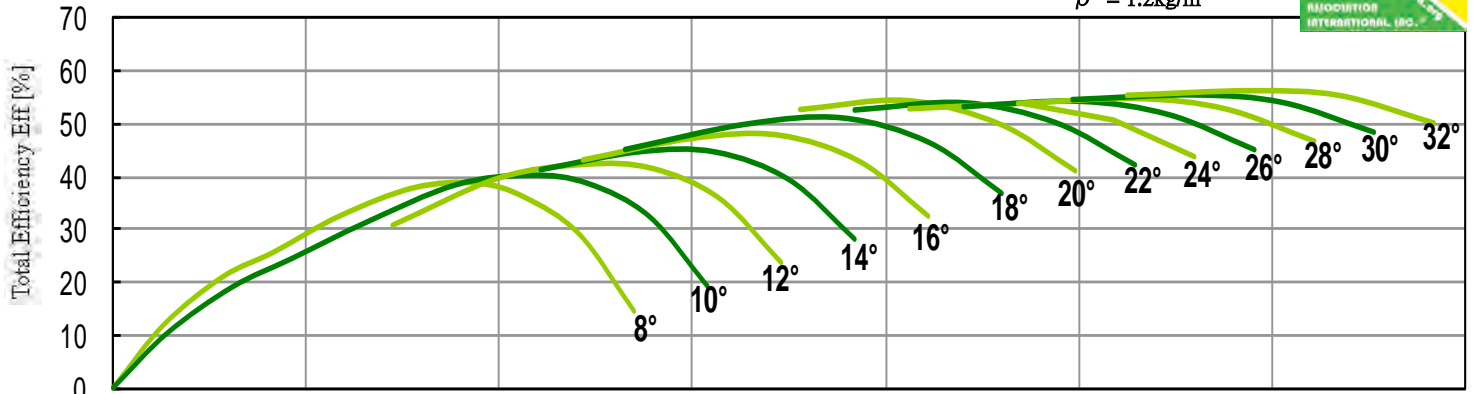

Performance certified is for installation type B: free inlet, ducted outlet. Performance ratings do not include the effects of appurtenances (accessories).



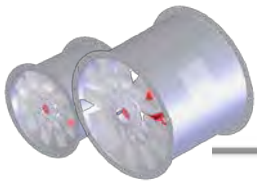

# Axial Fan Driven Directly

LASD-560-200-10 **50Hz** Performance curves

**FEG 60**

Fan Speed ; N = 960 [RPM] Outlet Area ; A = 0.2463 [m<sup>2</sup>]

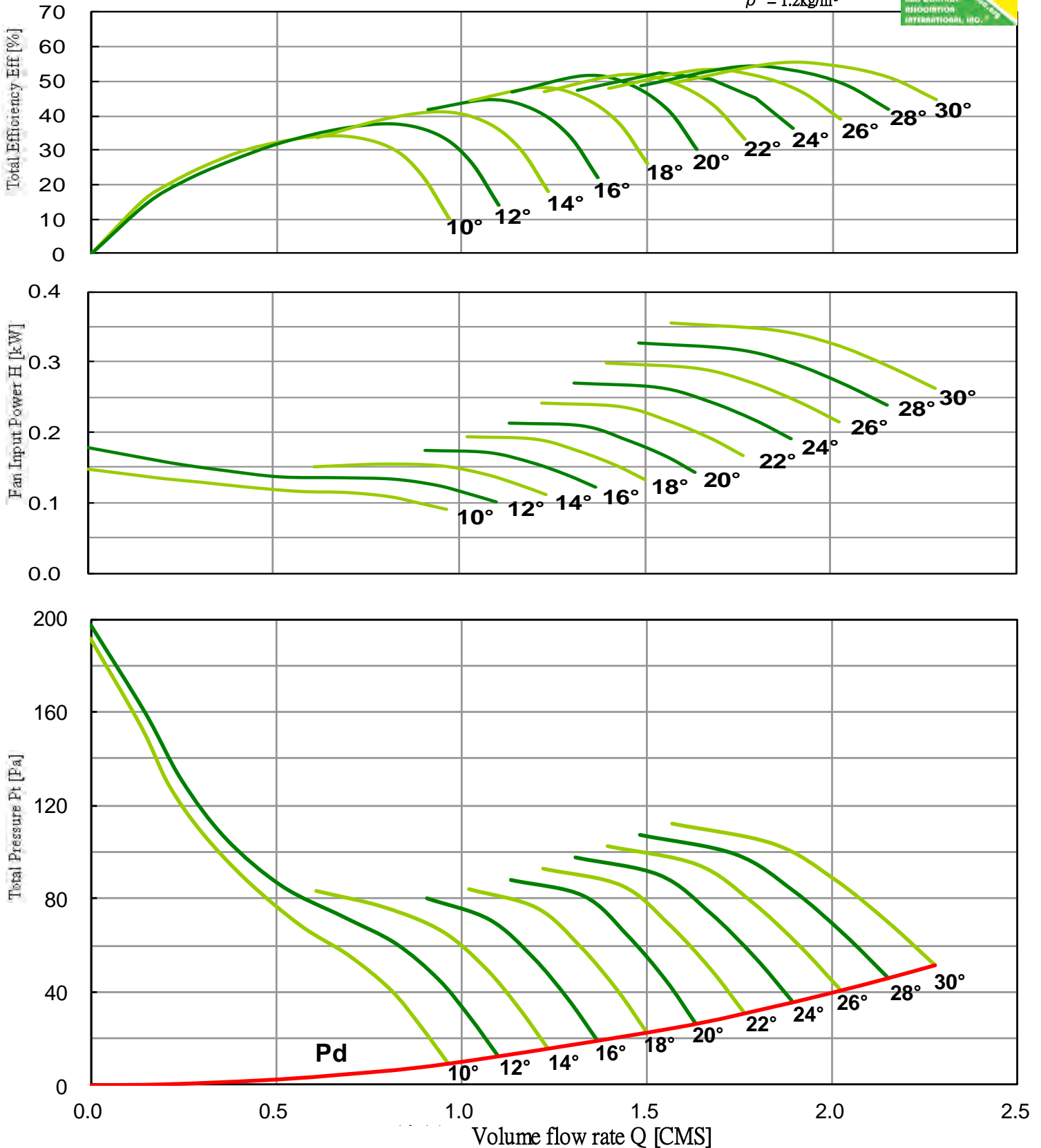

Performance certified is for installation type B: free inlet, ducted outlet. Performance ratings do not include the effects of appurtenances (accessories).

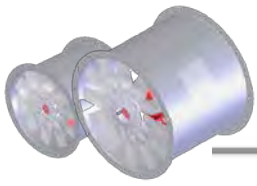

# Axial Fan Driven Directly



LASD-560-200-10 **50Hz** Performance curves

**FEG 60**

Fan Speed ; N = 1440 [RPM] Outlet Area ; A = 0.2463 [m<sup>2</sup>]



$\rho = 1.2\text{kg/m}^3$

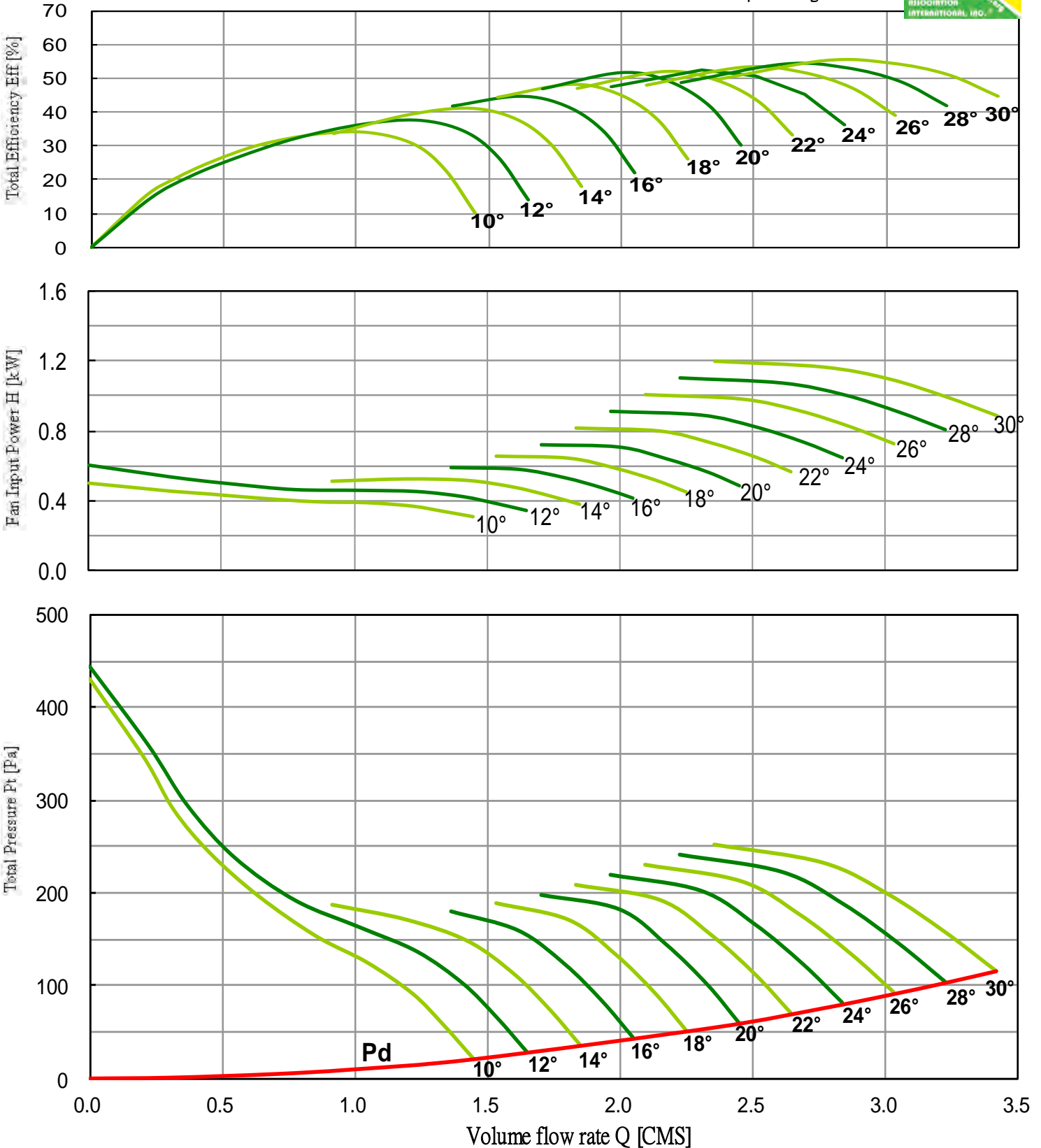

Performance certified is for installation type B: free inlet, ducted outlet. Performance ratings do not include the effects of appurtenances (accessories).

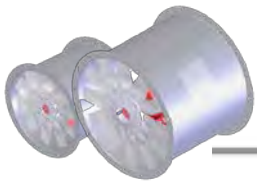

# Axial Fan Driven Directly



LASD-560-200-10 50Hz Performance curves

**FEG 60**

Fan Speed ; N = 2850 [RPM] Outlet Area ; A = 0.2463 [m<sup>2</sup>]



$\rho = 1.2\text{kg/m}^3$

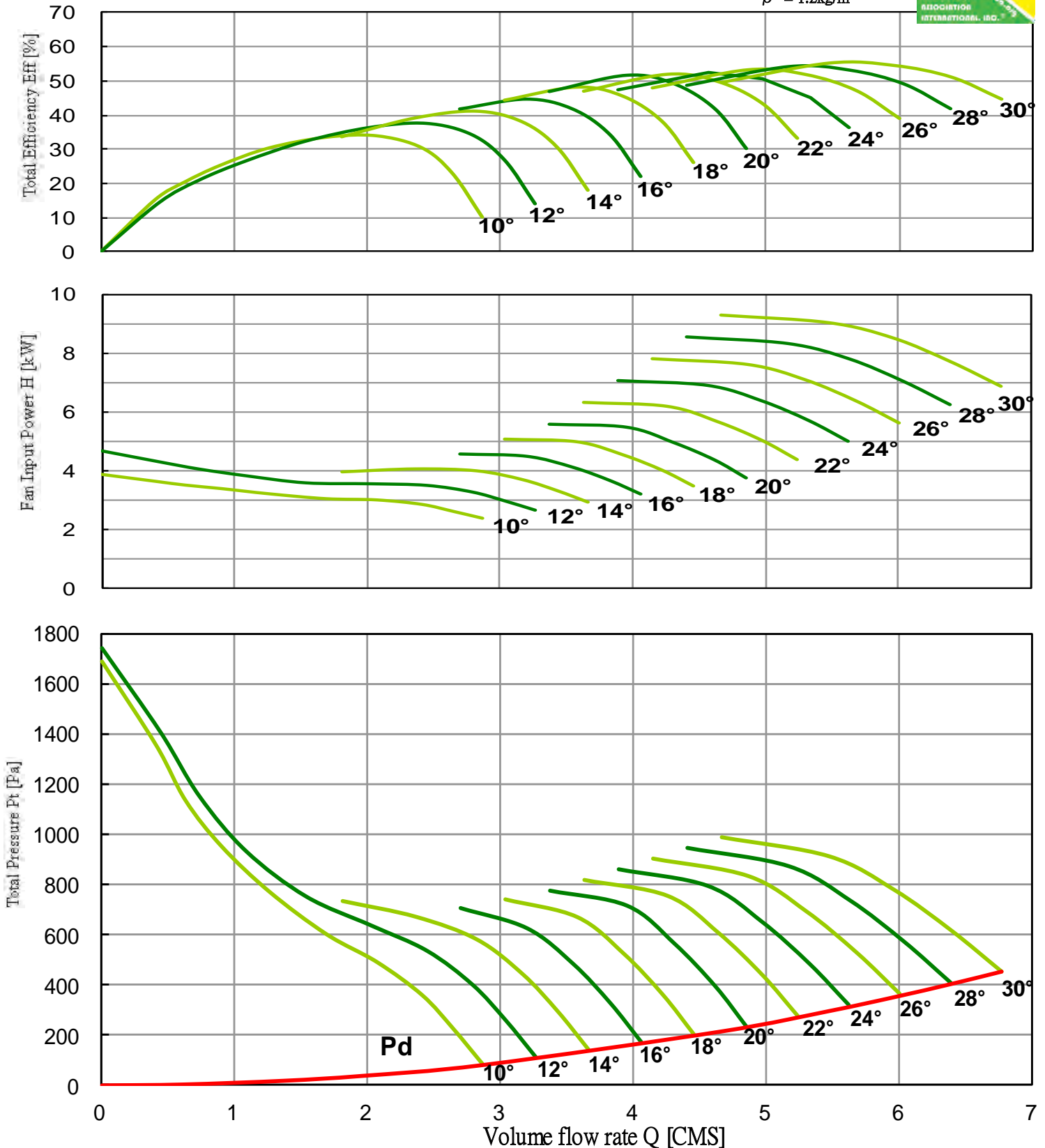

Performance certified is for installation type B: free inlet, ducted outlet. Performance ratings do not include the effects of appurtenances (accessories).

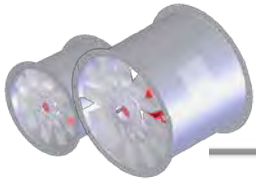

# Axial Fan Driven Directly



LASD-630-200-5 **50Hz** Performance curves

**FEG 67**

Fan Speed ; N = 960 [RPM] Outlet Area ; A = 0.3167 [m<sup>2</sup>]

$\rho = 1.2\text{kg/m}^3$

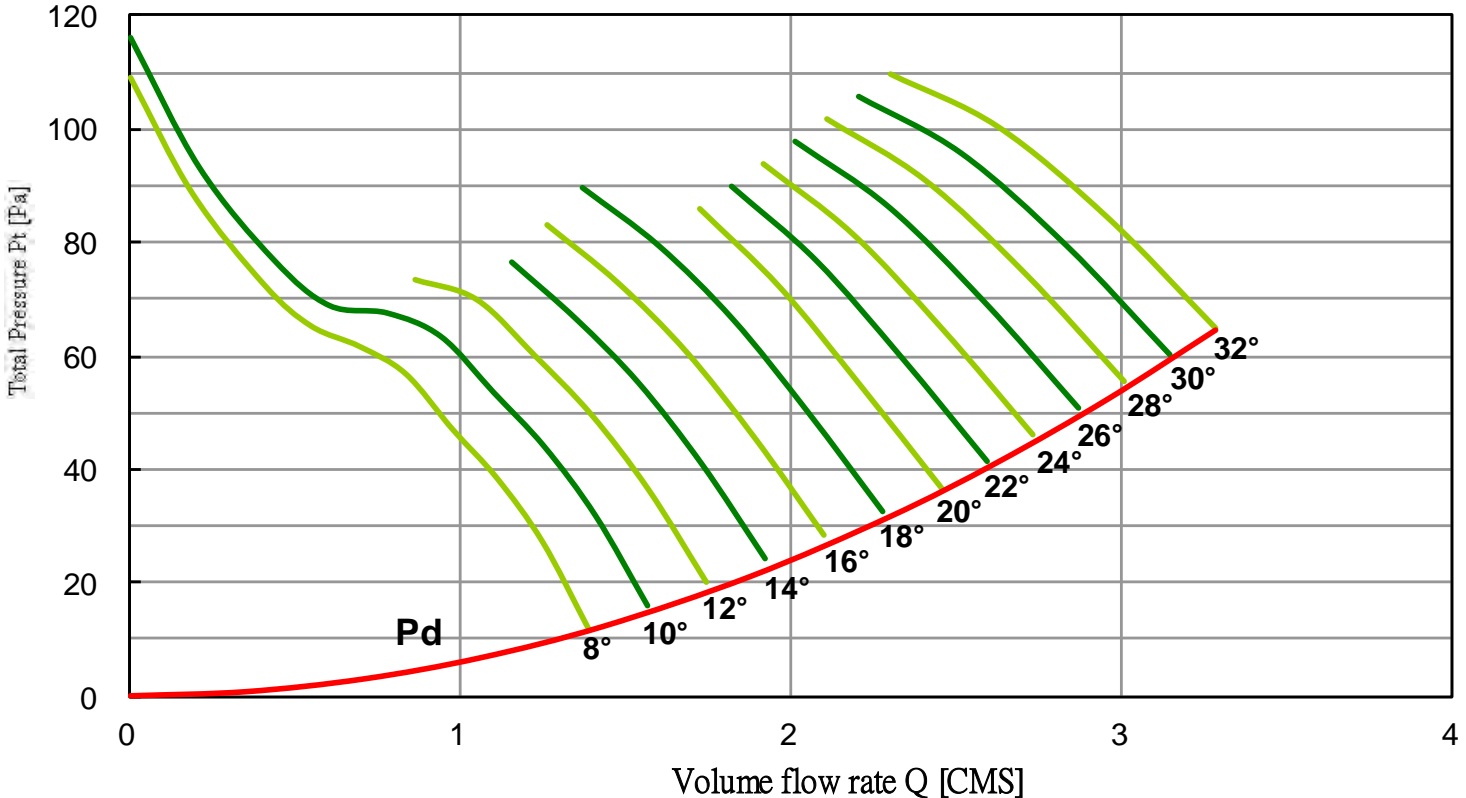
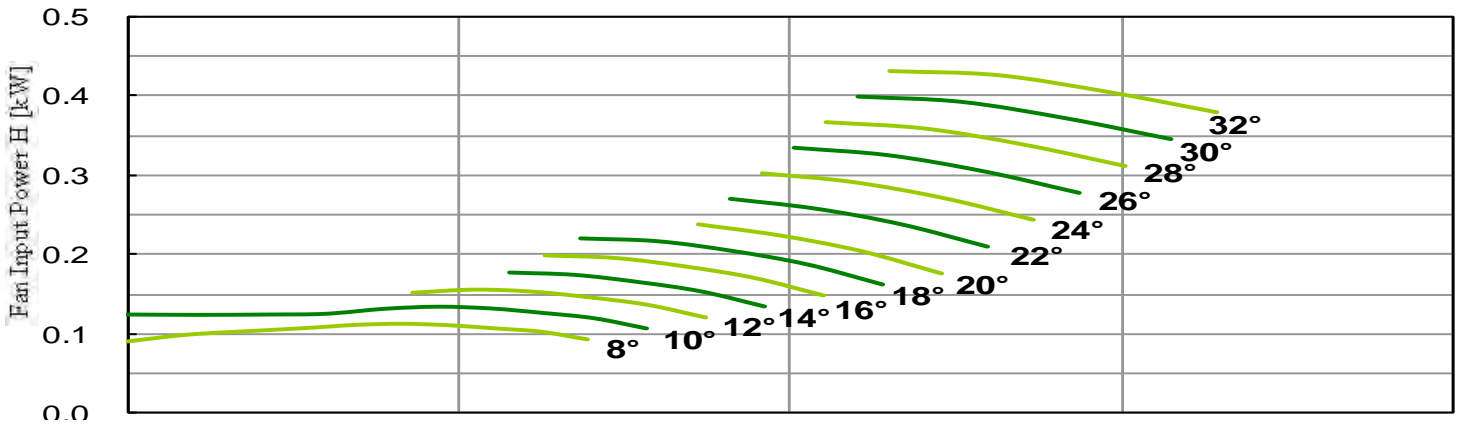
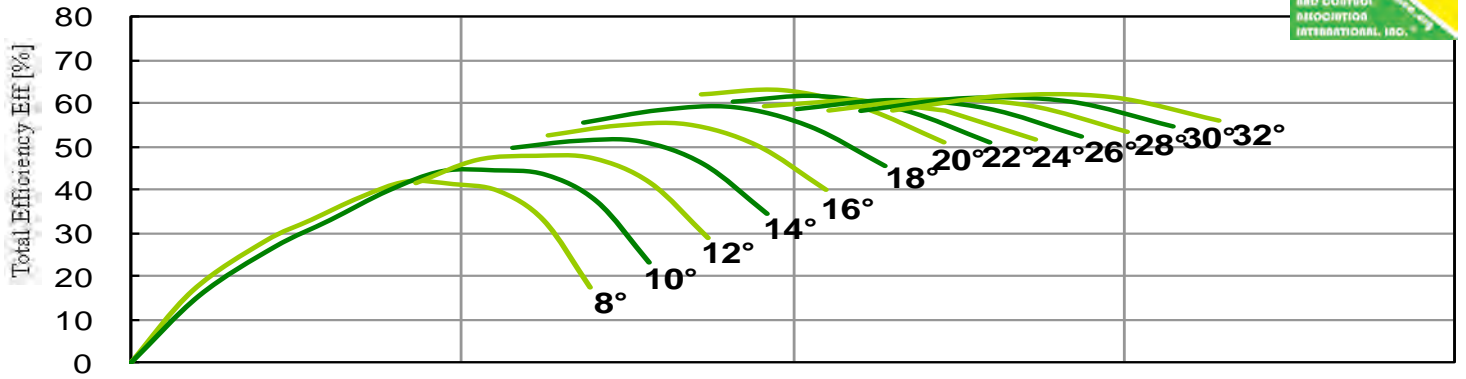

Performance certified is for installation type B: free inlet, ducted outlet. Performance ratings do not include the effects of appurtenances (accessories).

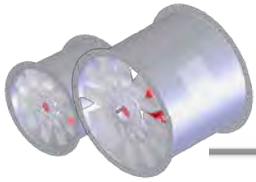

# Axial Fan Driven Directly



LASD-630-200-5 **50Hz** Performance curves

**FEG 67**

Fan Speed ; N = 1440 [RPM] Outlet Area ; A = 0.3167 [m<sup>2</sup>]

$\rho = 1.2\text{kg/m}^3$

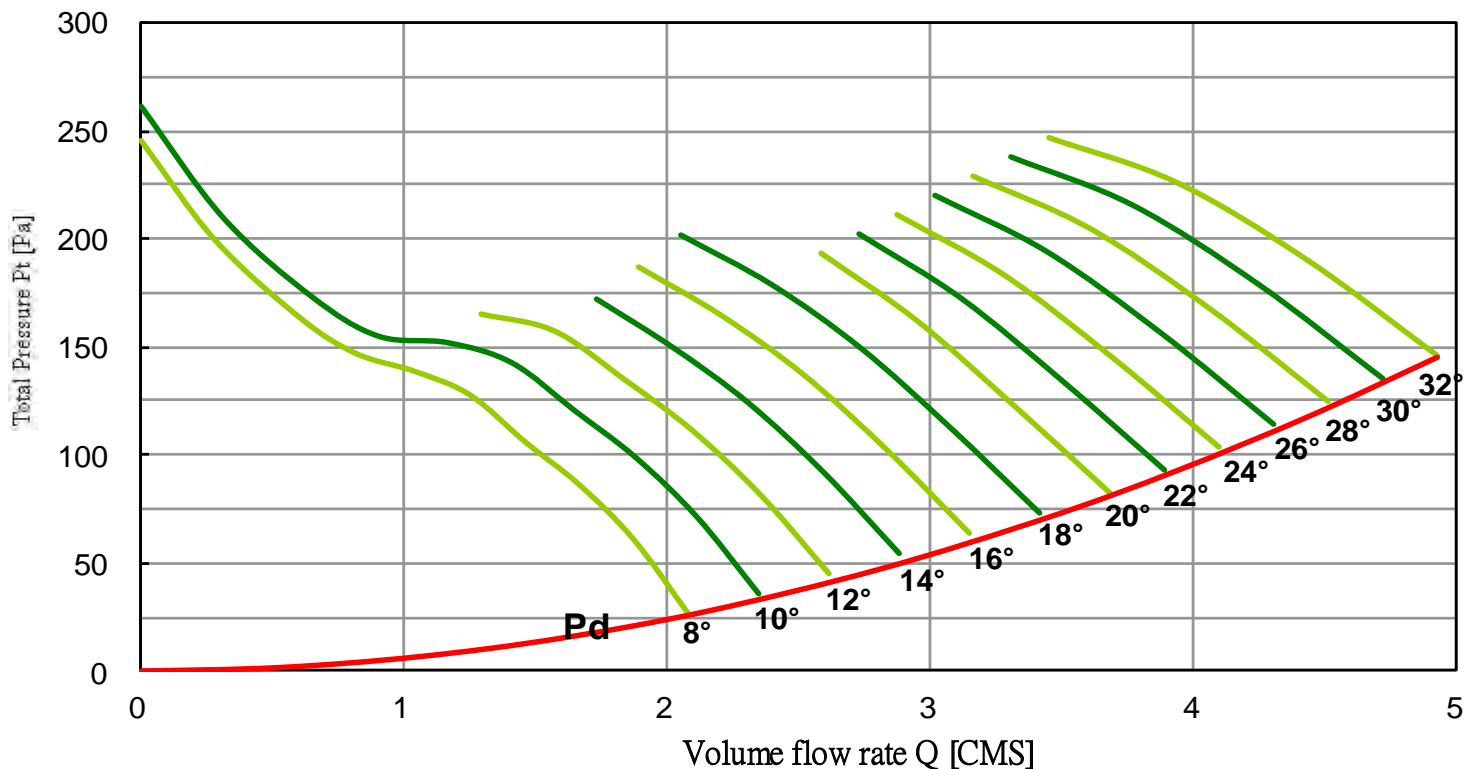
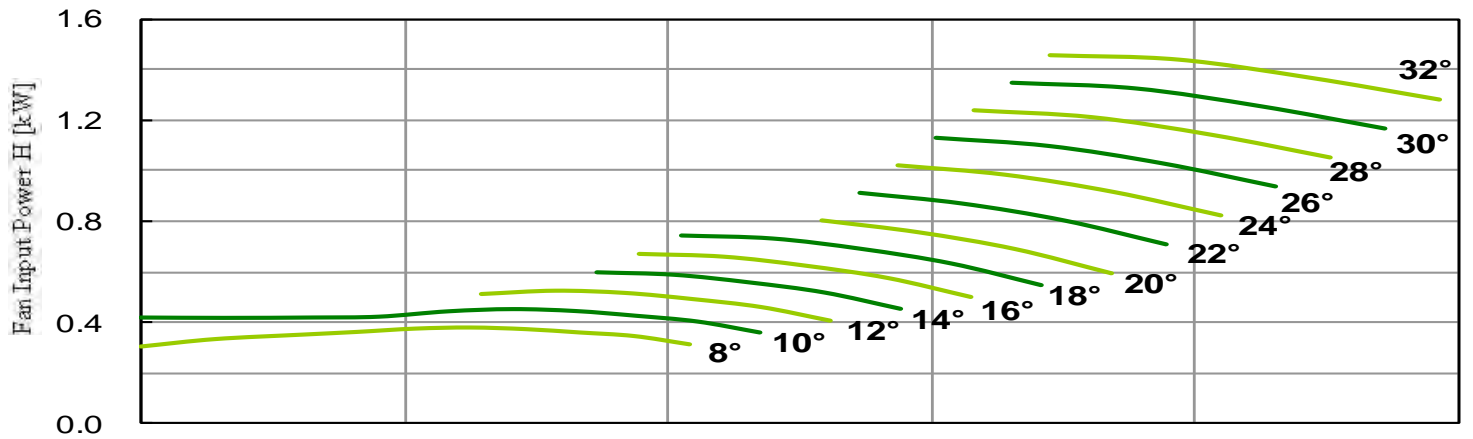
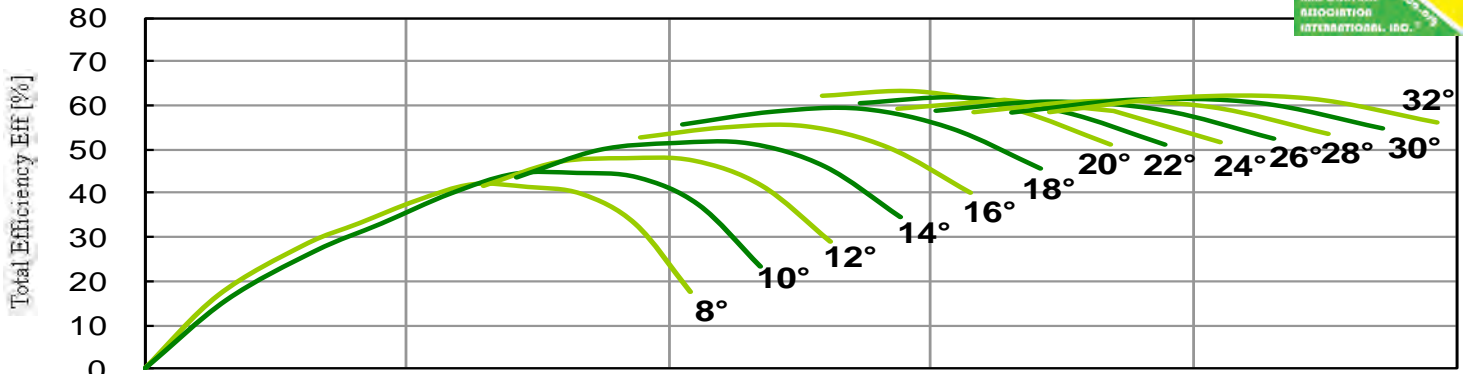

Performance certified is for installation type B : free inlet, ducted outlet. Performance ratings do not include the effects of appurtenances (accessories).

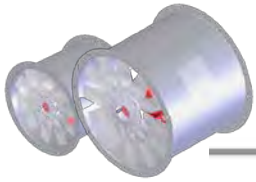

# Axial Fan Driven Directly



LASD-630-200-5 **50Hz** Performance curves



**FEG 67**

Fan Speed ;  $N = 2850$  [RPM]    Outlet Area ;  $A = 0.3167$  [m<sup>2</sup>]

$\rho = 1.2$ kg/m<sup>3</sup>

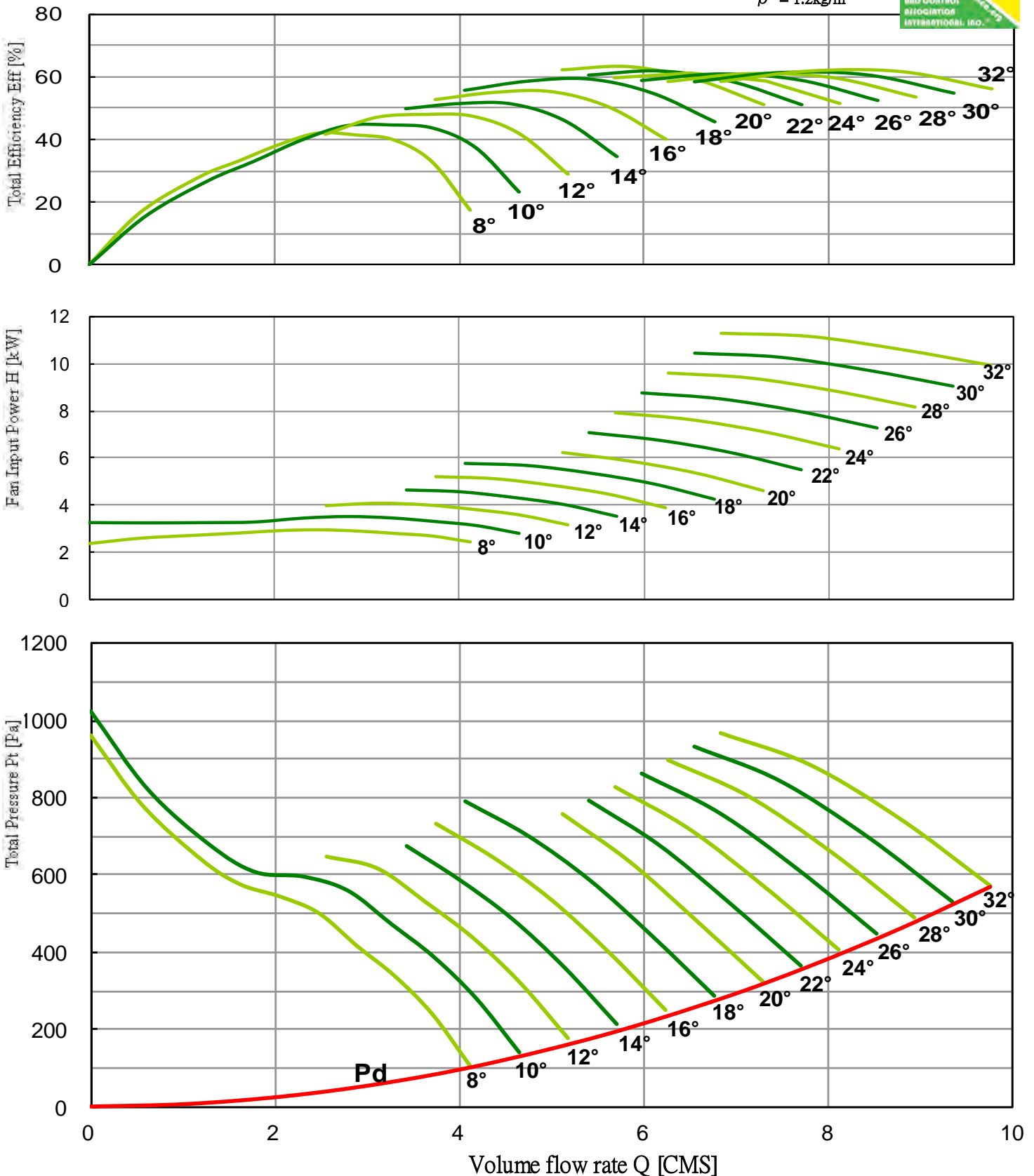

Performance certified is for installation type B : free inlet, ducted outlet. Performance ratings do not include the effects of appurtenances (accessories).



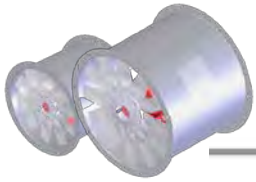

# Axial Fan Driven Directly



LASD-630-300-6 **50Hz** Performance curves



**FEG 63**

Fan Speed ; N = 960 [RPM] Outlet Area ; A = 0.3167 [m<sup>2</sup>]

$\rho = 1.2\text{kg/m}^3$

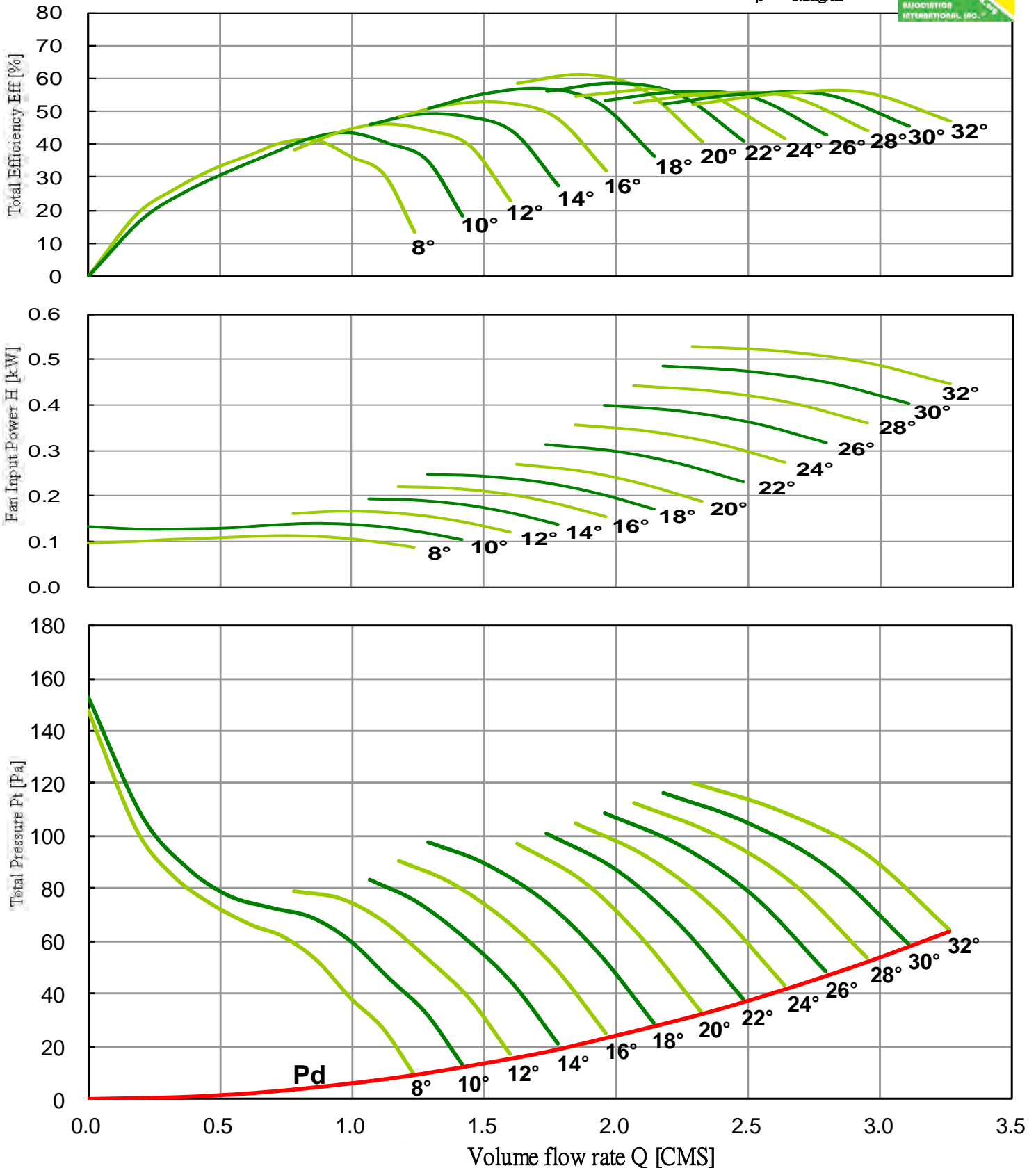

Performance certified is for installation type B: free inlet, ducted outlet. Performance ratings do not include the effects of appurtenances (accessories).

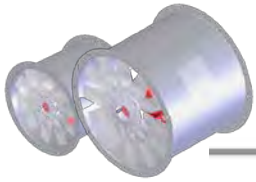

# Axial Fan Driven Directly



LASD-630-300-6 **50Hz** Performance curves



## FEG 63

Fan Speed ;  $N = 1440$  [RPM]    Outlet Area ;  $A = 0.3167$  [m<sup>2</sup>]

$\rho = 1.2\text{kg/m}^3$

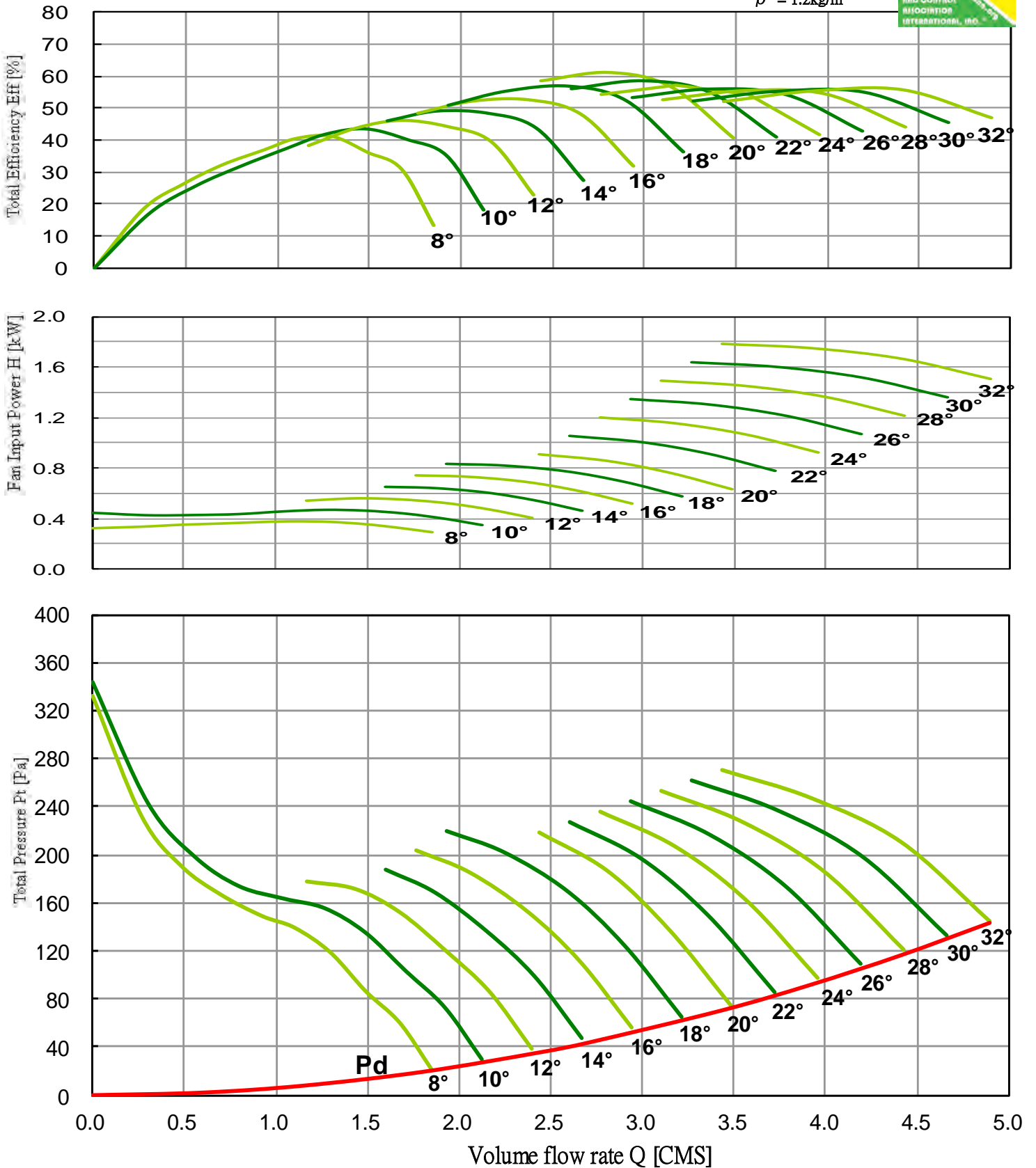

Performance certified is for installation type B: free inlet, ducted outlet. Performance ratings do not include the effects of appurtenances (accessories).



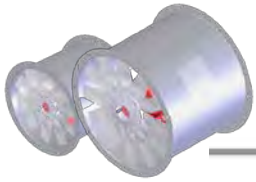

# Axial Fan Driven Directly



LASD-630-300-6 **50Hz** Performance curves



**FEG 63**

Fan Speed ; N = 2850 [RPM]    Outlet Area ; A = 0.3167 [m<sup>2</sup>]

$\rho = 1.2\text{kg/m}^3$

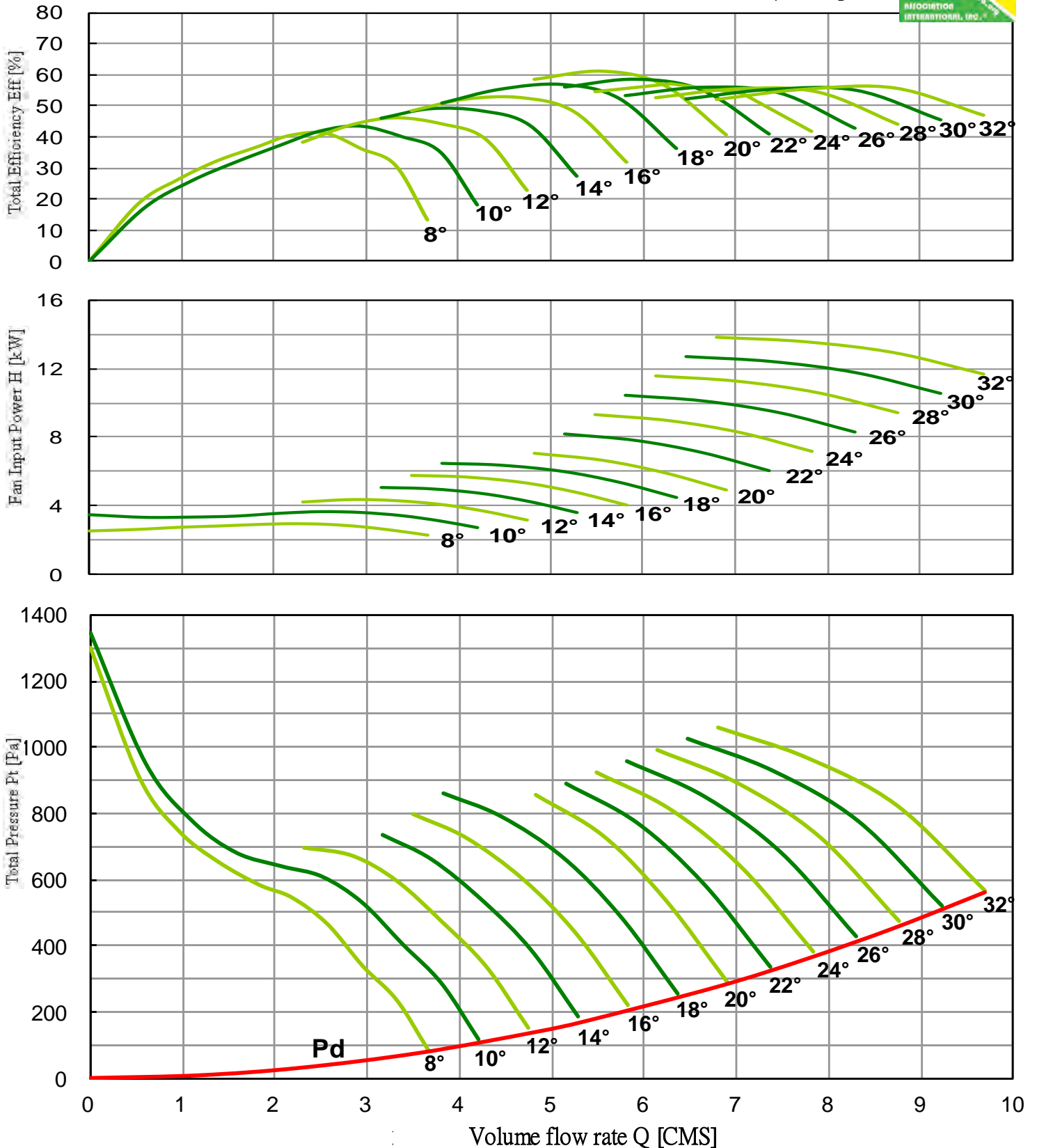

Performance certified is for installation type B: free inlet, ducted outlet. Performance ratings do not include the effects of appurtenances (accessories).

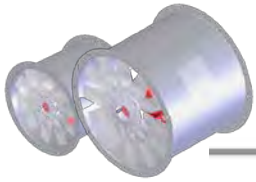

# Axial Fan Driven Directly



LASD-630-200-10 **50Hz** Performance curves

**FEG 67**

Fan Speed ; N = 960 [RPM] Outlet Area ; A = 0.3167 [m<sup>2</sup>]



$\rho = 1.2\text{kg/m}^3$

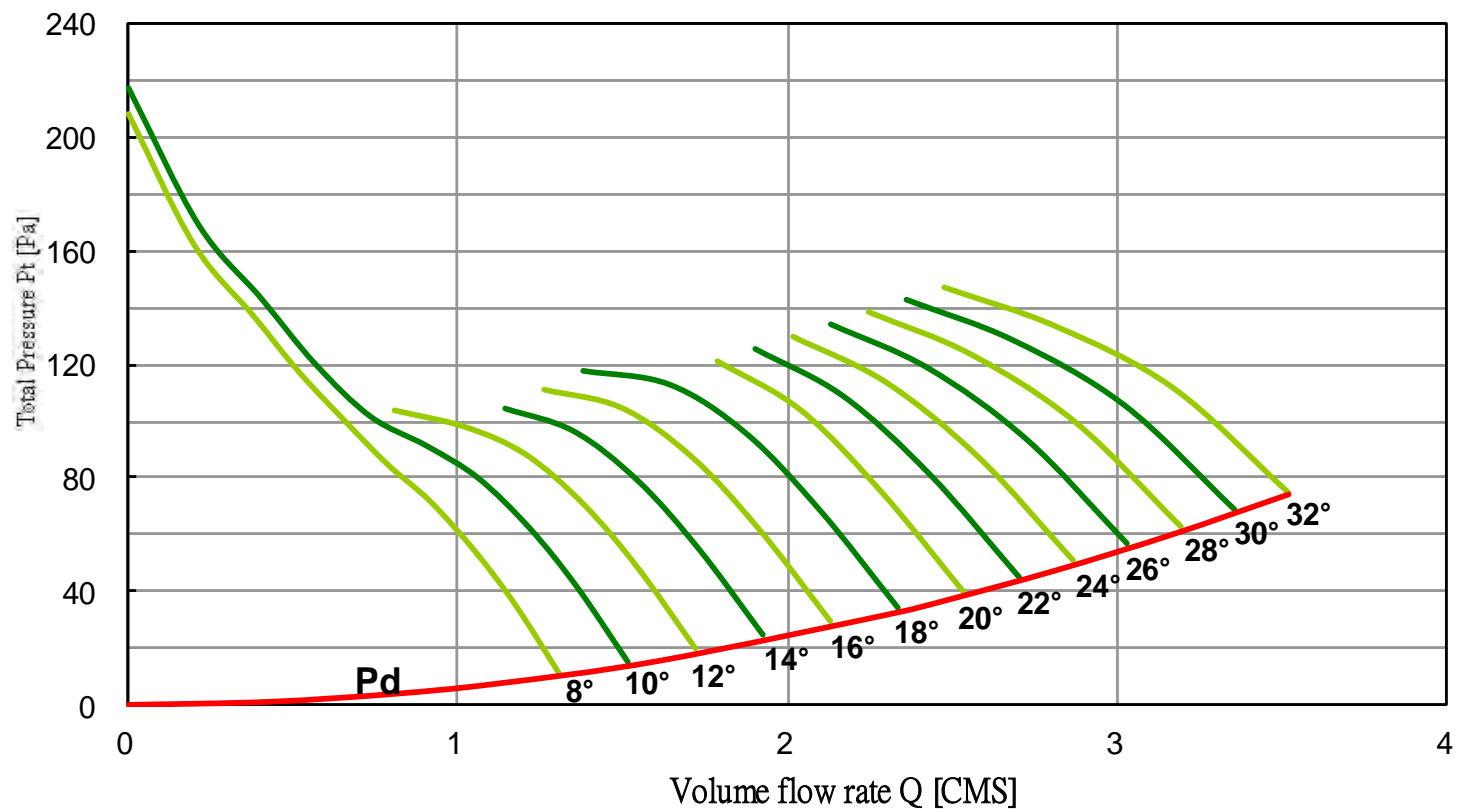
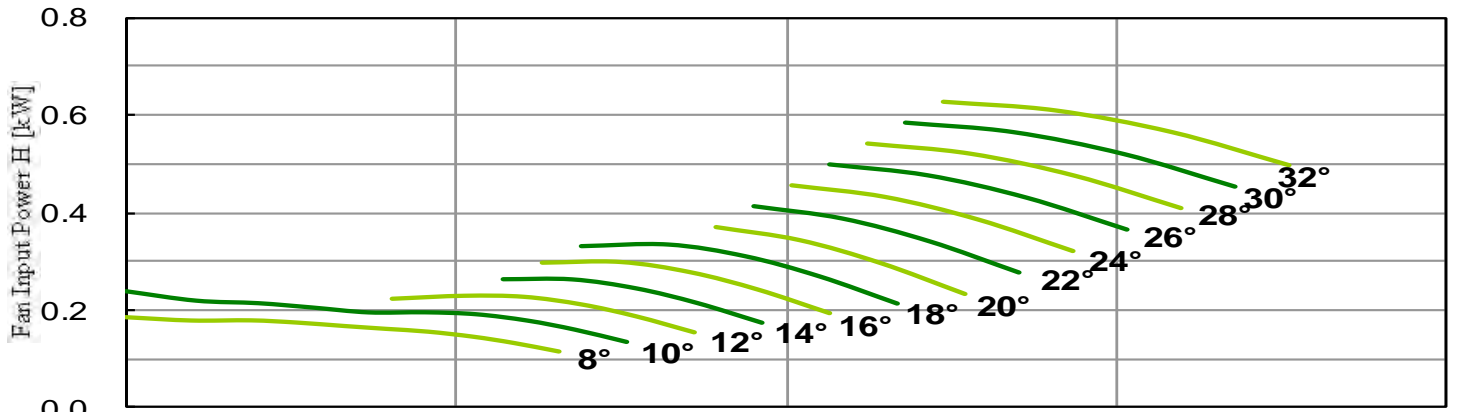
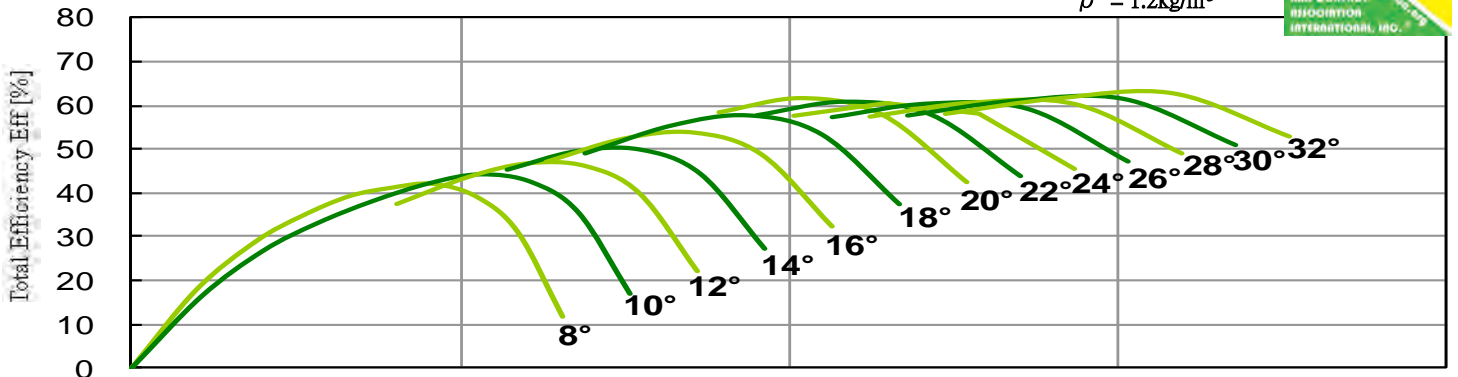

Performance certified is for installation type B: free inlet, ducted outlet. Performance ratings do not include the effects of appurtenances (accessories).

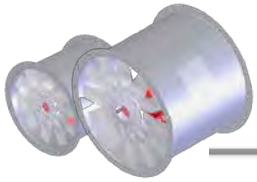

# Axial Fan Driven Directly



LASD-630-200-10 **50Hz** Performance curves

**FEG 67**

Fan Speed ; N = 1440 [RPM] Outlet Area ; A = 0.3167 [m<sup>2</sup>]

$\rho = 1.2\text{kg/m}^3$

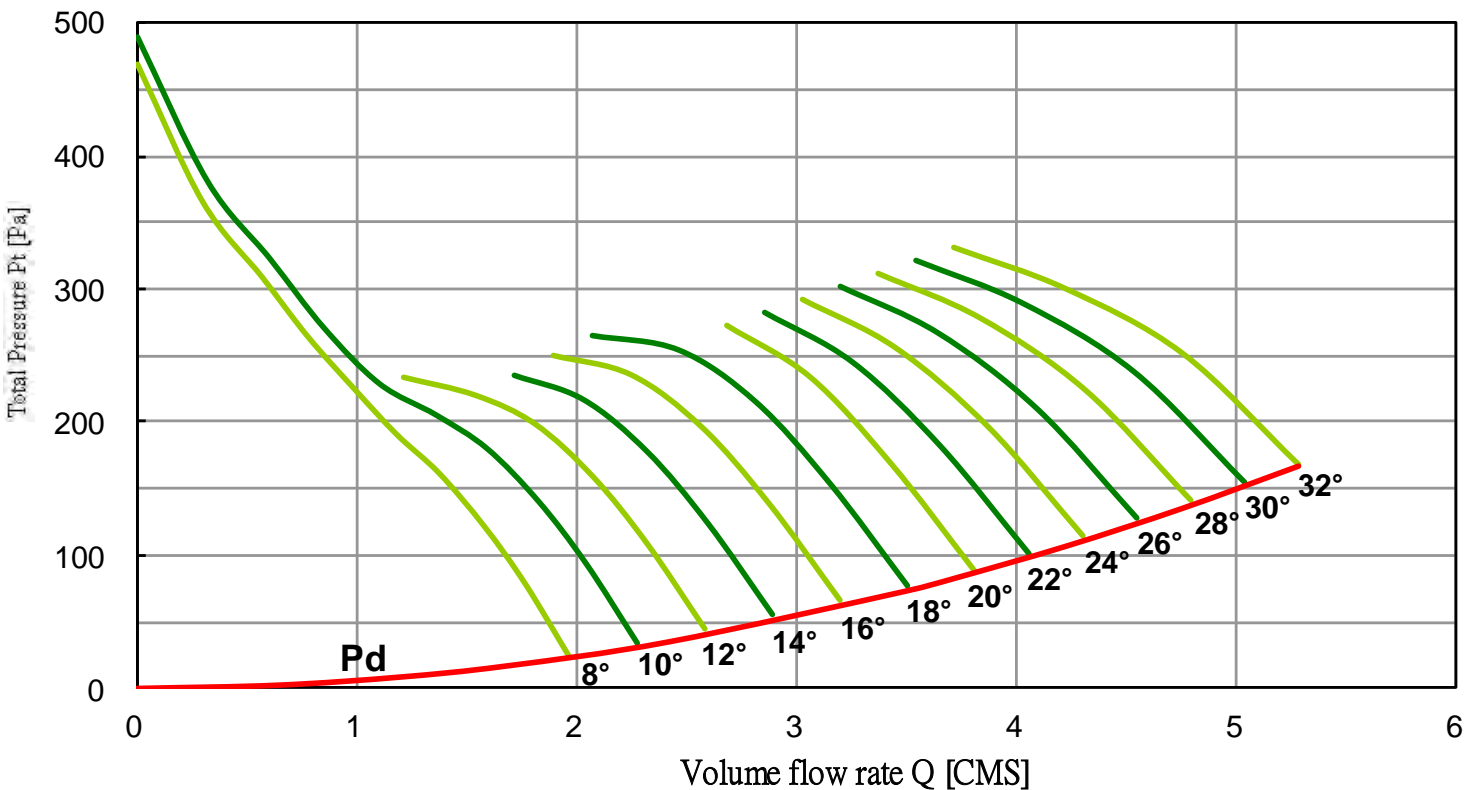
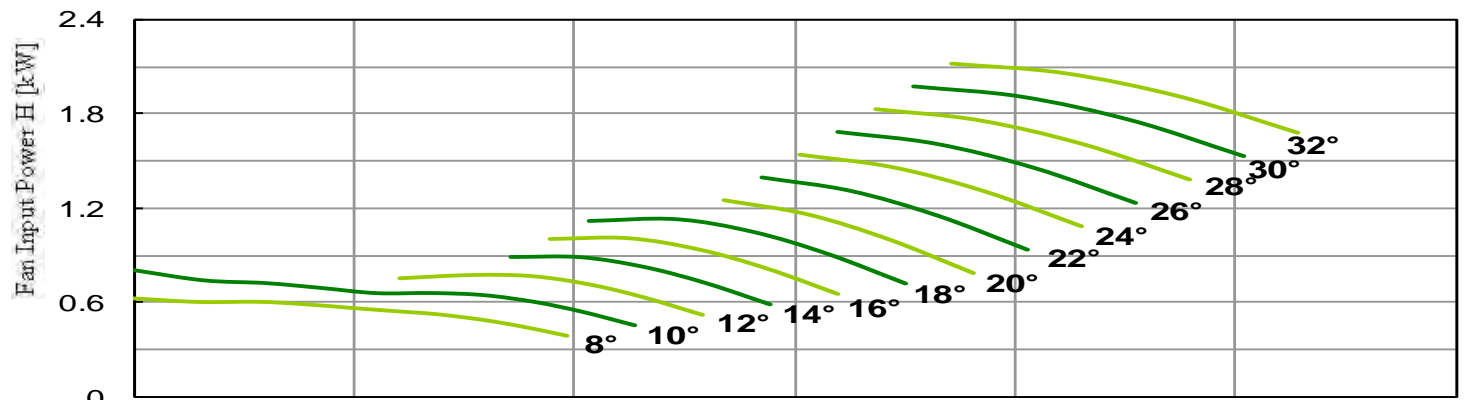
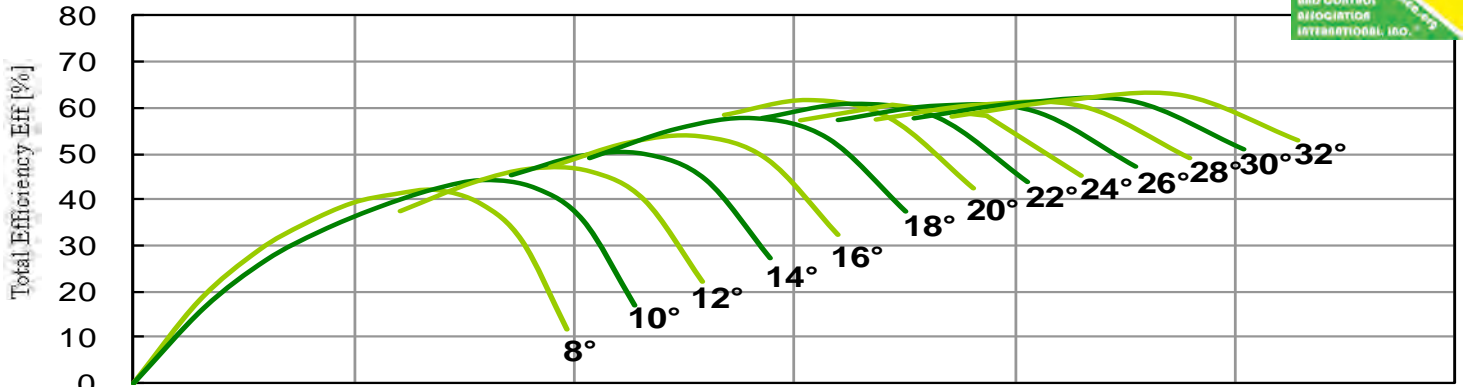

Performance certified is for installation type B: free inlet, ducted outlet. Performance ratings do not include the effects of appurtenances (accessories).

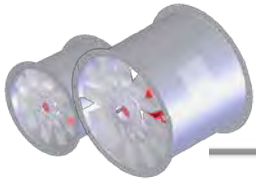

# Axial Fan Driven Directly



LASD-630-200-10 **50Hz** Performance curves

**FEG 67**

Fan Speed ; N = 2850 [RPM] Outlet Area ; A = 0.3167 [m<sup>2</sup>]

$\rho = 1.2\text{kg/m}^3$

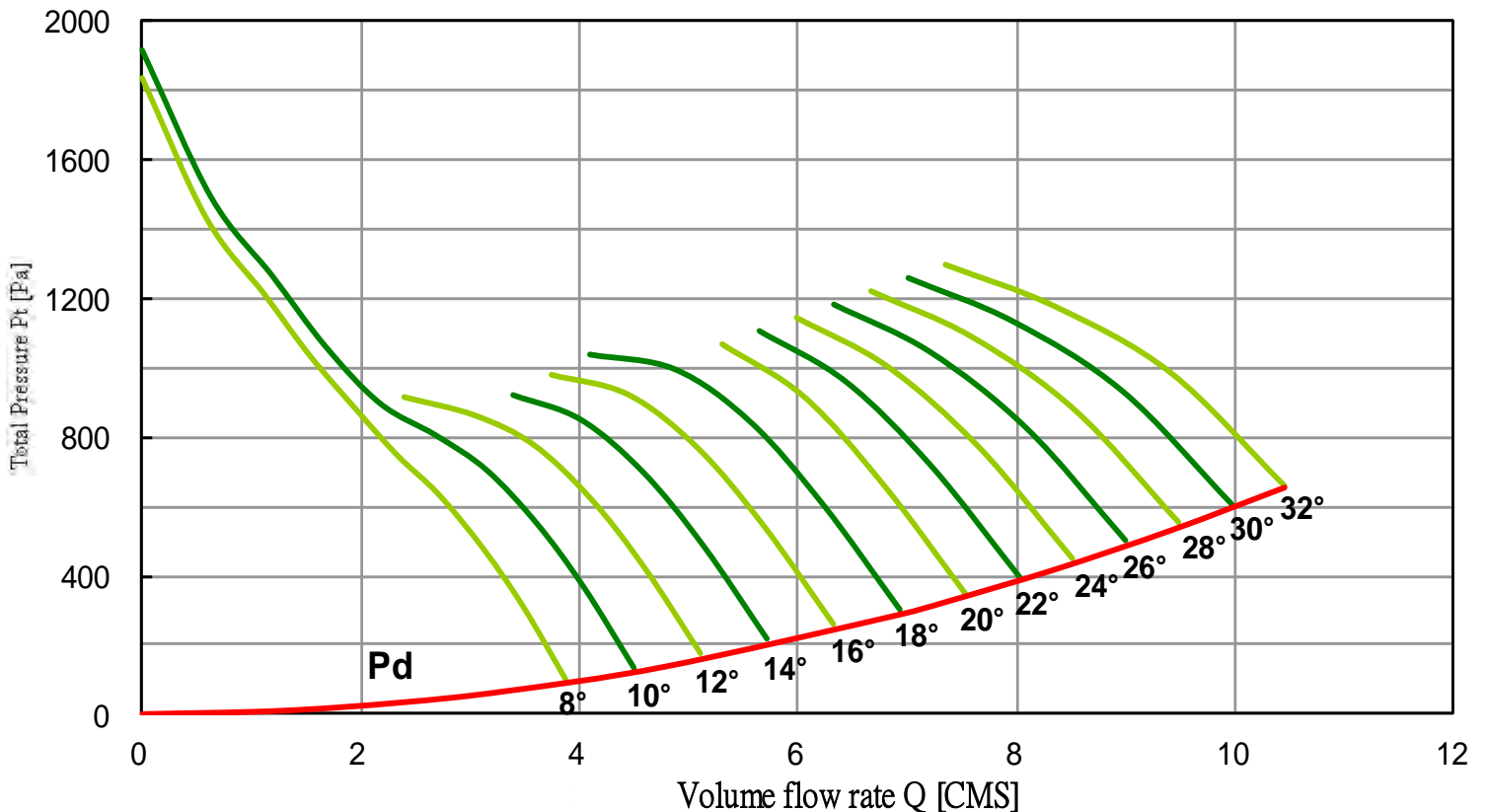
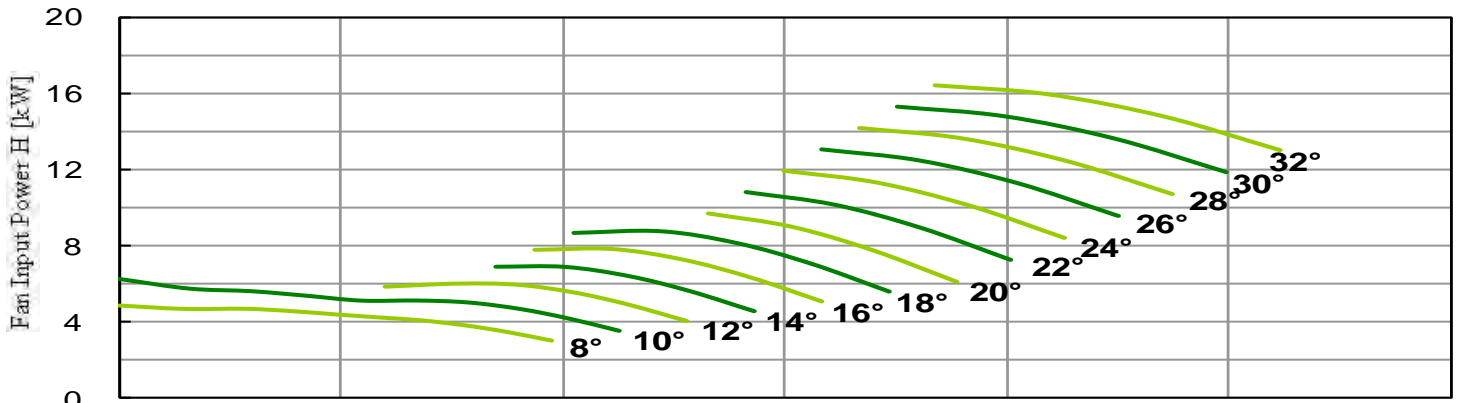
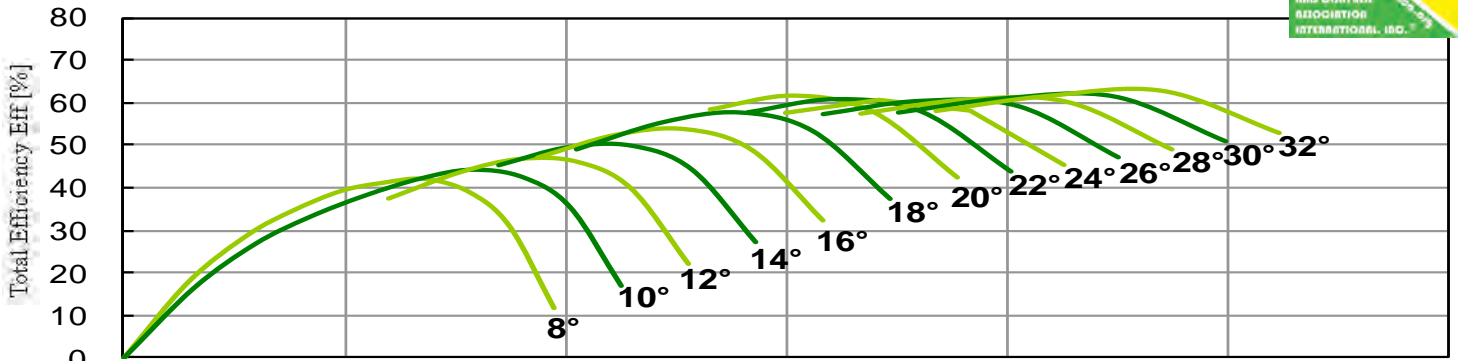

Performance certified is for installation type B: free inlet, ducted outlet. Performance ratings do not include the effects of appurtenances (accessories).

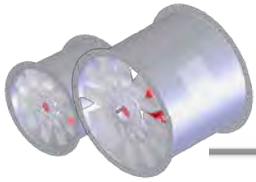

# Axial Fan Driven Directly



LASD-630-300-12 **50Hz** Performance curves

**FEG 56**

Fan Speed ;  $N = 960$  [RPM] Outlet Area ;  $A = 0.3167$  [m<sup>2</sup>]



$\rho = 1.2$ kg/m<sup>3</sup>

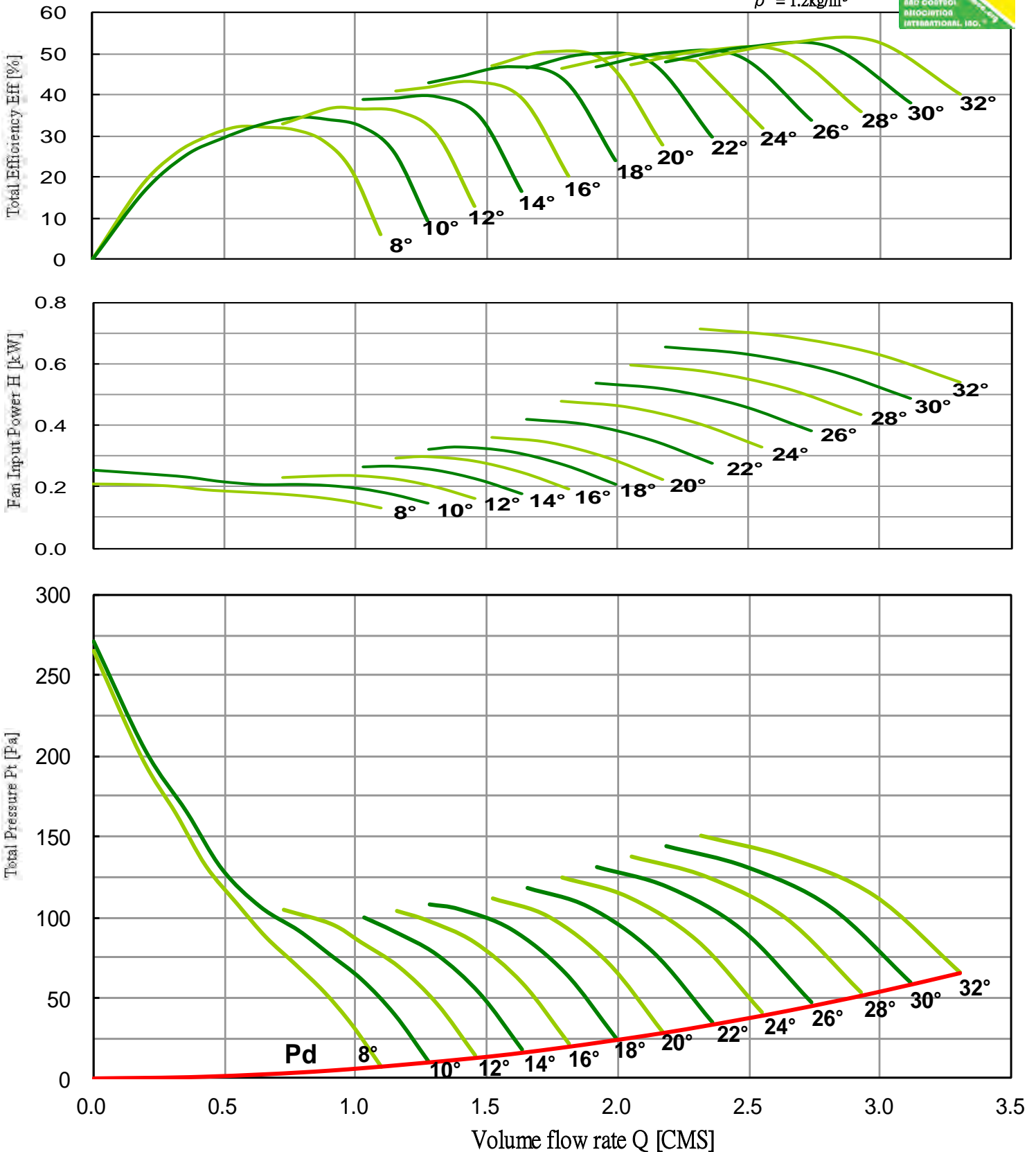

Performance certified is for installation type B: free inlet, ducted outlet. Performance ratings do not include the effects of appurtenances (accessories).

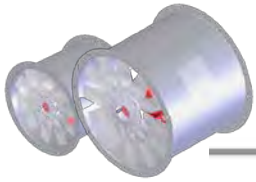

# Axial Fan Driven Directly



LASD-630-300-12 **50Hz** Performance curves



**FEG 56**

Fan Speed ; N = 1440 [RPM] Outlet Area ; A = 0.3167 [m<sup>2</sup>]

$\rho = 1.2\text{kg/m}^3$

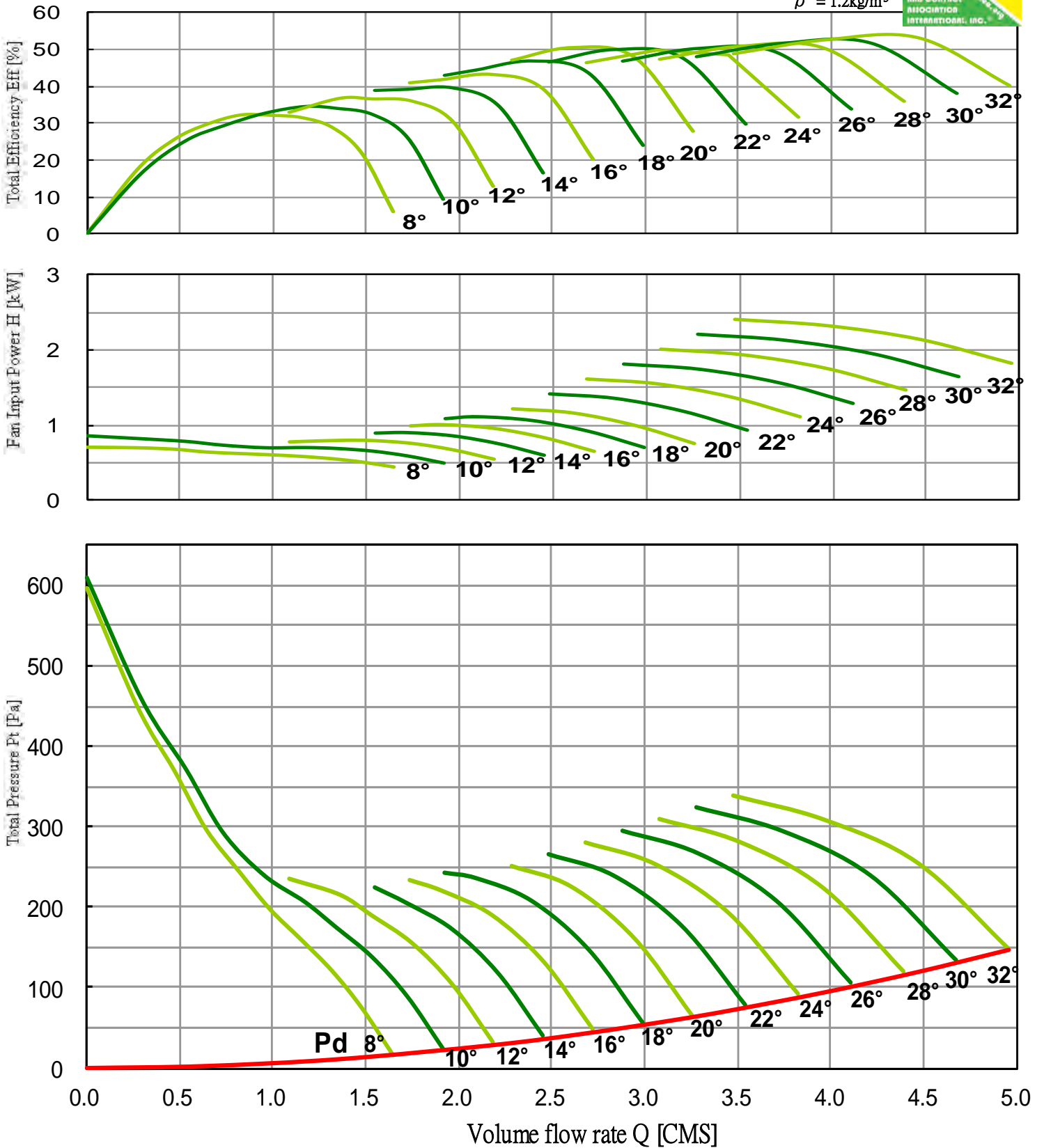

Performance certified is for installation type B: free inlet, ducted outlet. Performance ratings do not include the effects of appurtenances (accessories).



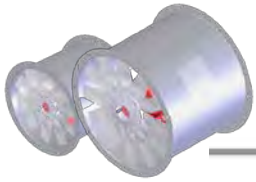

# Axial Fan Driven Directly



LASD-630-300-12 **50Hz** Performance curves



**FEG 56**

Fan Speed ;  $N = 2850$  [RPM]    Outlet Area ;  $A = 0.3167$  [m<sup>2</sup>]

$\rho = 1.2$ kg/m<sup>3</sup>

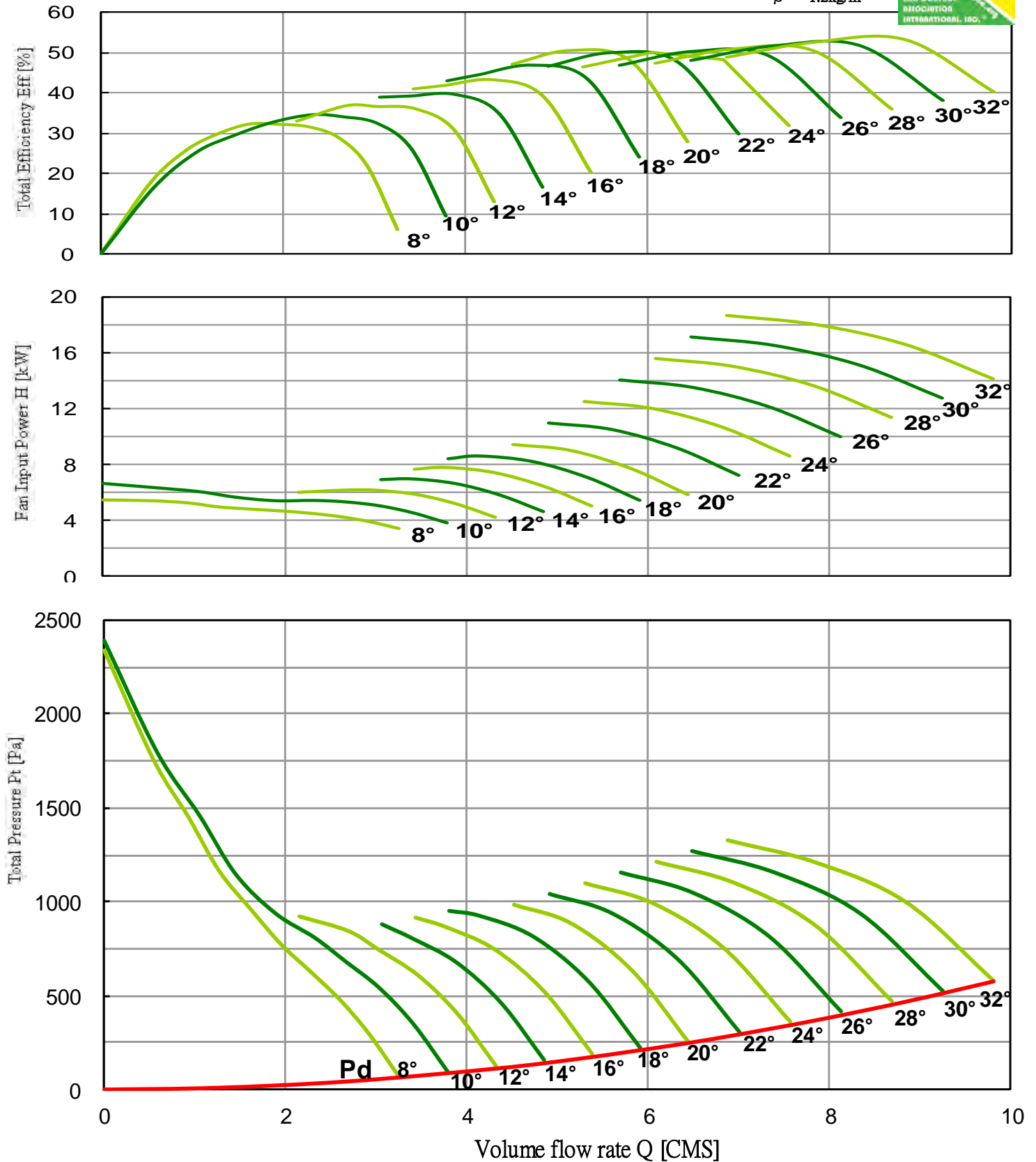

Performance certified is for installation type B: free inlet, ducted outlet. Performance ratings do not include the effects of appurtenances (accessories).

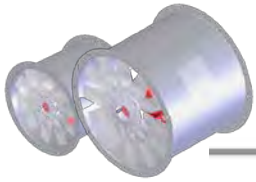

# Axial Fan Driven Directly



LASD-710-300-6

50Hz

Performance curves



**FEG 63**

Fan Speed ;  $N = 720$  [RPM]

Outlet Area ;  $A = 0.3959$  [m<sup>2</sup>]

$\rho = 1.2\text{kg/m}^3$

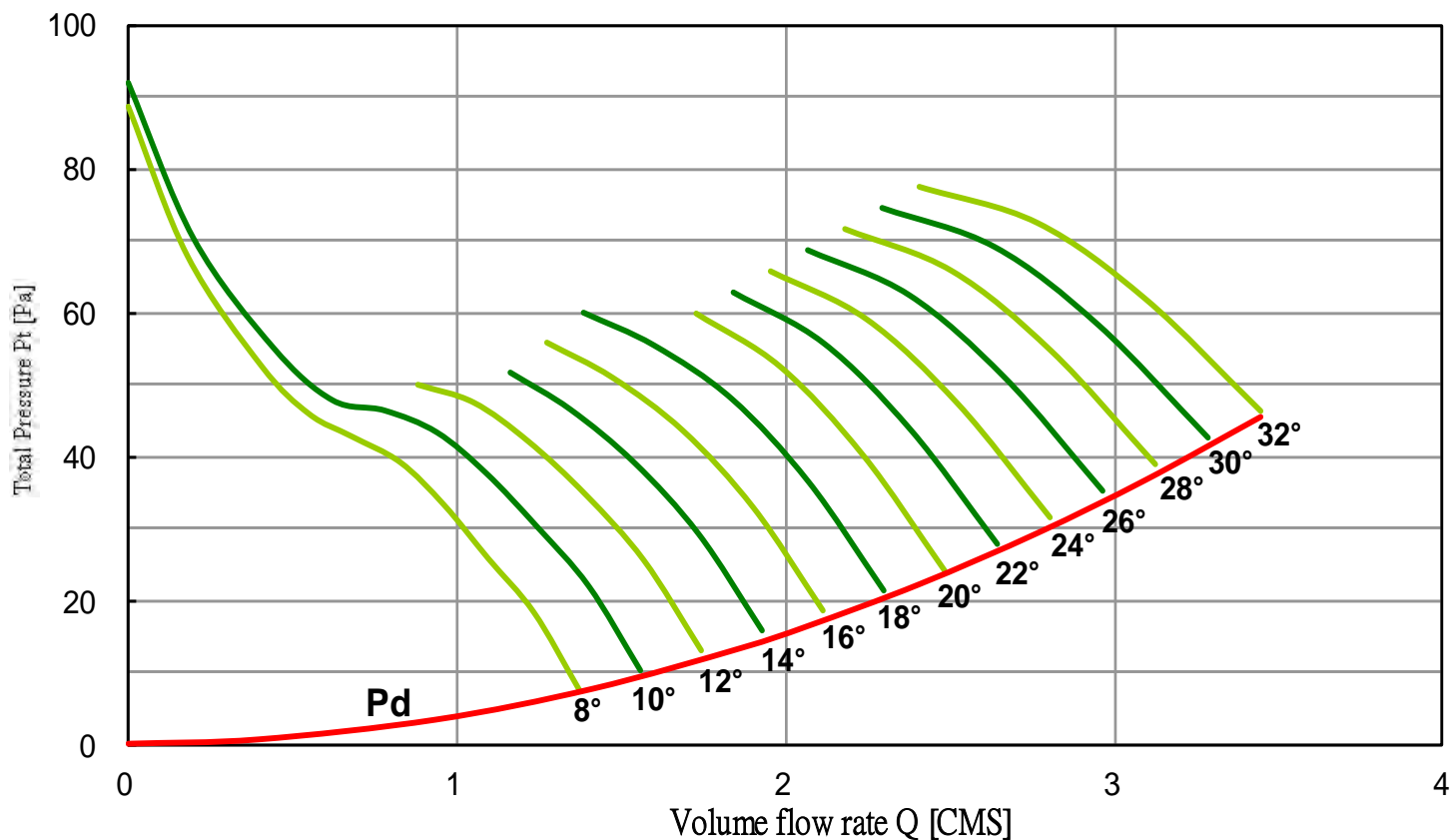
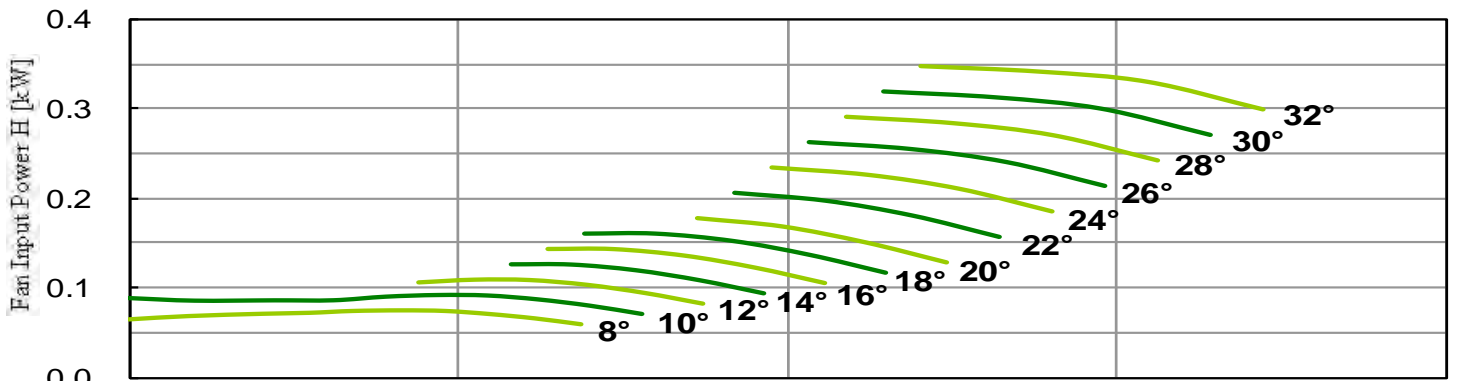
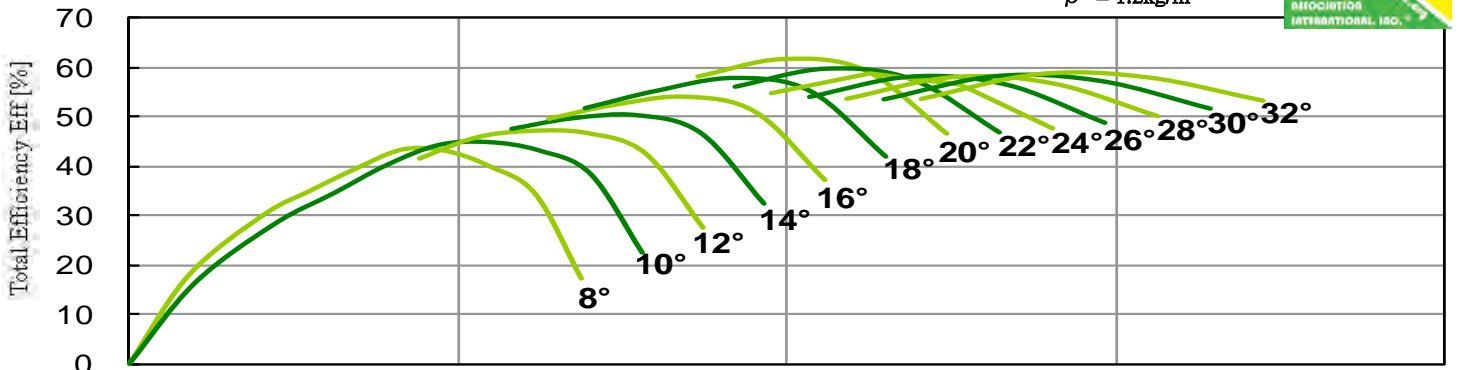

Performance certified is for installation type B: free inlet, ducted outlet. Performance ratings do not include the effects of appurtenances (accessories).



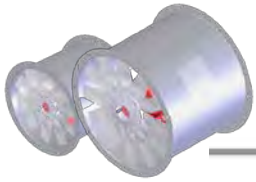

# Axial Fan Driven Directly



LASD-710-300-6 **50Hz** Performance curves



**FEG 63**

Fan Speed ; N = 960 [RPM]    Outlet Area ; A = 0.3959 [m<sup>2</sup>]

$\rho = 1.2\text{kg/m}^3$

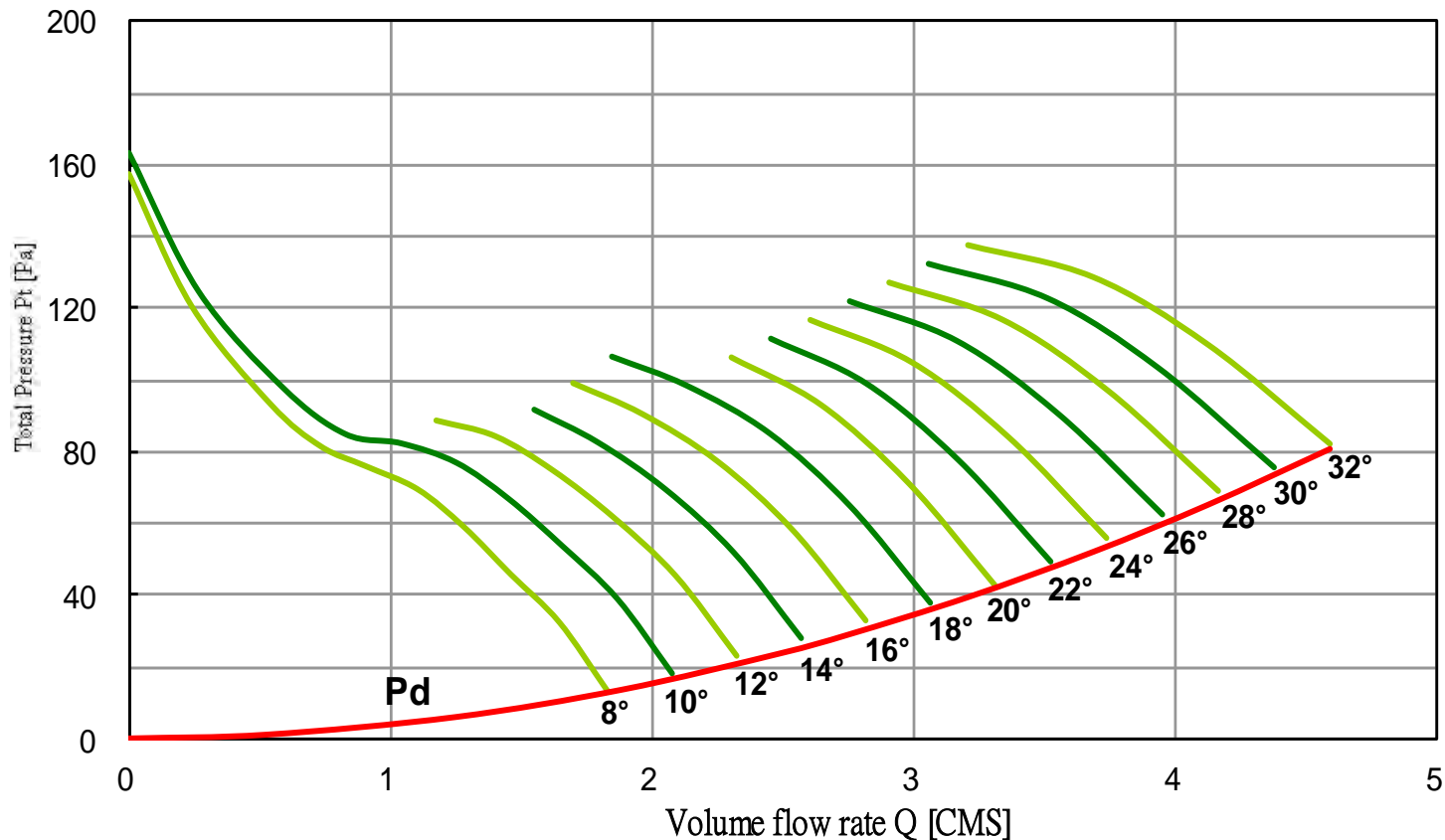
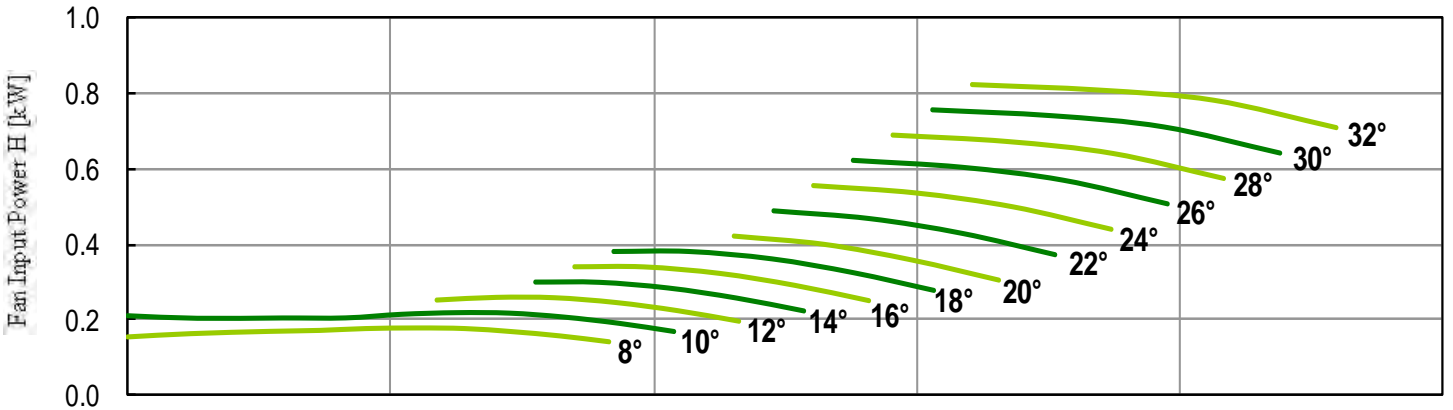
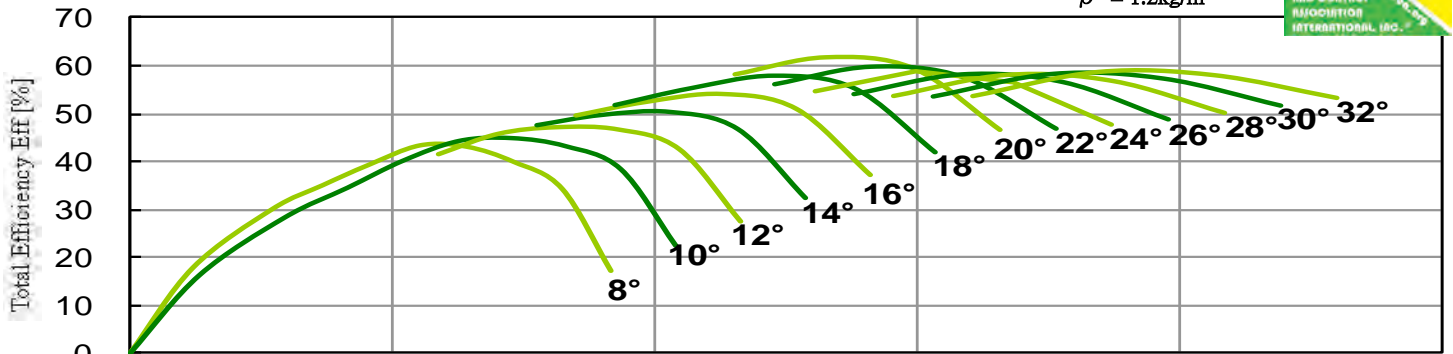

Performance certified is for installation type B: free inlet, ducted outlet. Performance ratings do not include the effects of appurtenances (accessories).

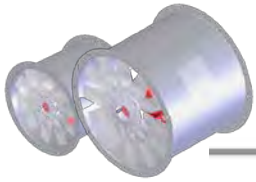

# Axial Fan Driven Directly



LASD-710-300-6

50Hz

Performance curves



**FEG 63**

Fan Speed ; N = 1440 [RPM]

Outlet Area ; A = 0.3959 [m<sup>2</sup>]

$\rho = 1.2\text{kg/m}^3$

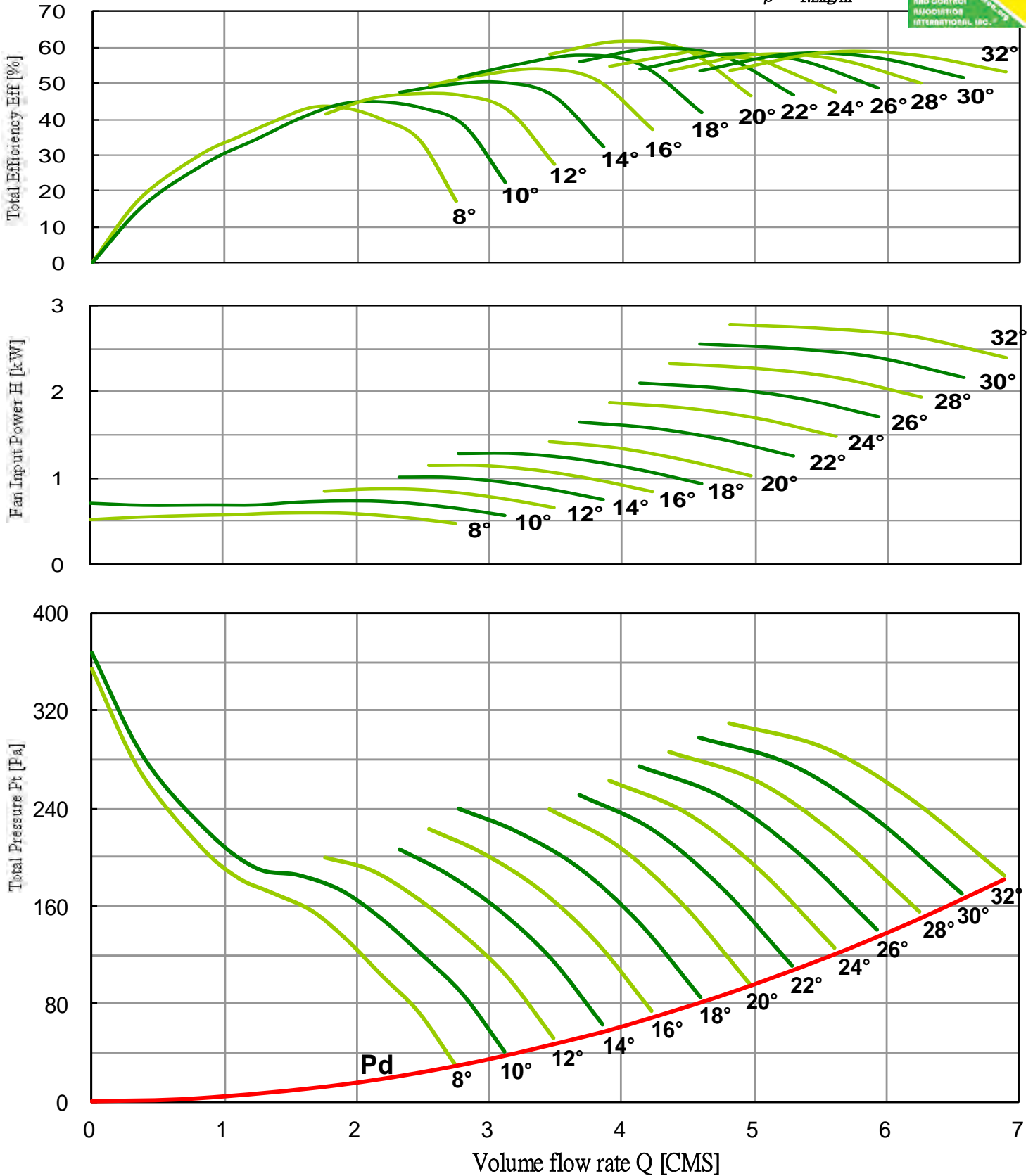

Performance certified is for installation type B: free inlet, ducted outlet. Performance ratings do not include the effects of appurtenances (accessories).

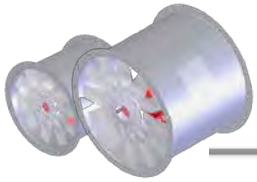

# Axial Fan Driven Directly



LASD-710-300-6

50Hz

Performance curves



**FEG 63**

Fan Speed ; N = 2850 [RPM]

Outlet Area ; A = 0.3959 [m<sup>2</sup>]

$\rho = 1.2\text{kg/m}^3$

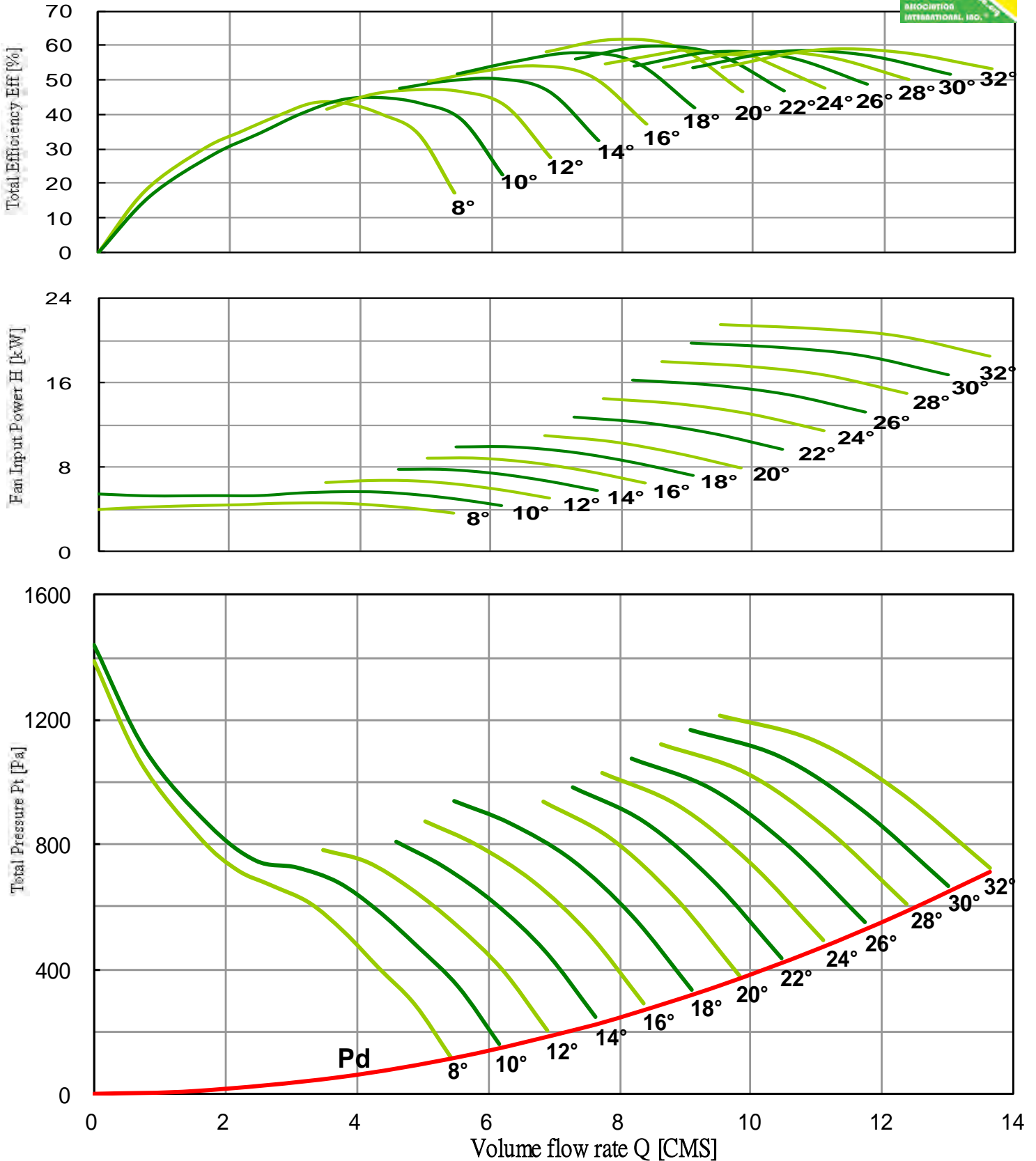

Performance certified is for installation type B: free inlet, ducted outlet. Performance ratings do not include the effects of appurtenances (accessories).

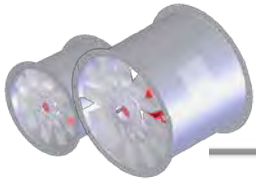

# Axial Fan Driven Directly



LASD-710-300-12 **50Hz** Performance curves



**FEG 60**

Fan Speed ; N = 720 [RPM]    Outlet Area ; A = 0.3959 [m<sup>2</sup>]

$\rho = 1.2\text{kg/m}^3$

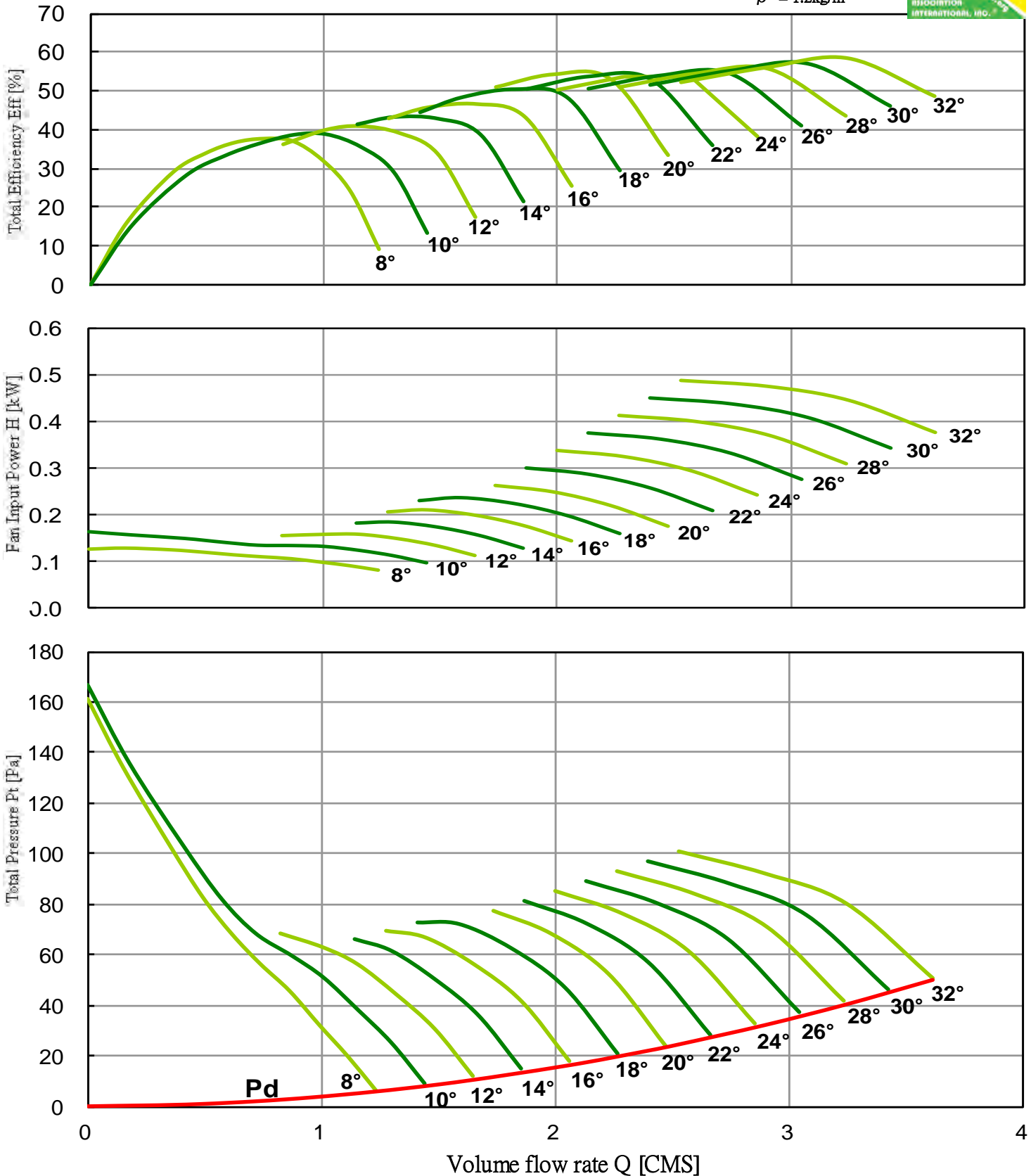

Performance certified is for installation type B: free inlet, ducted outlet. Performance ratings do not include the effects of appurtenances (accessories).

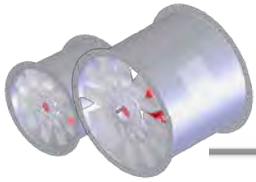

# Axial Fan Driven Directly



LASD-710-300-12 **50Hz** Performance curves



**FEG 60**

Fan Speed ;  $N = 960$  [RPM]    Outlet Area ;  $A = 0.3959$  [m<sup>2</sup>]

$\rho = 1.2$ kg/m<sup>3</sup>

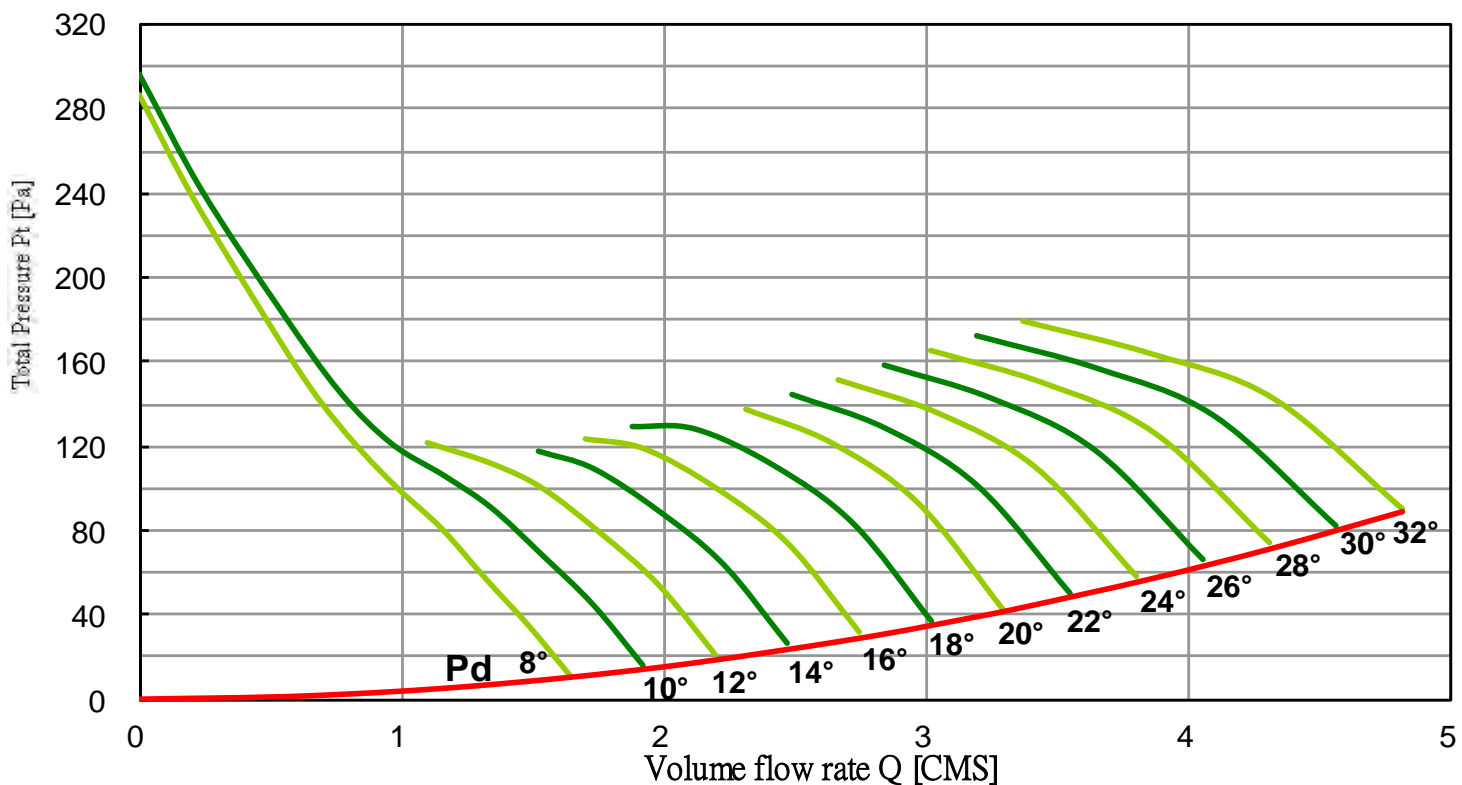
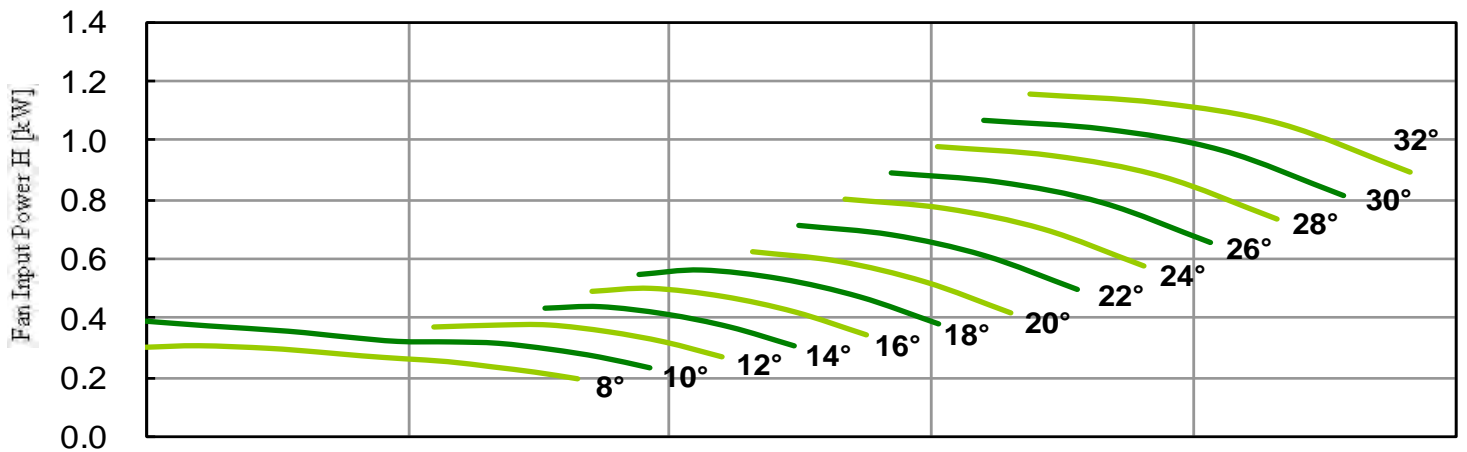
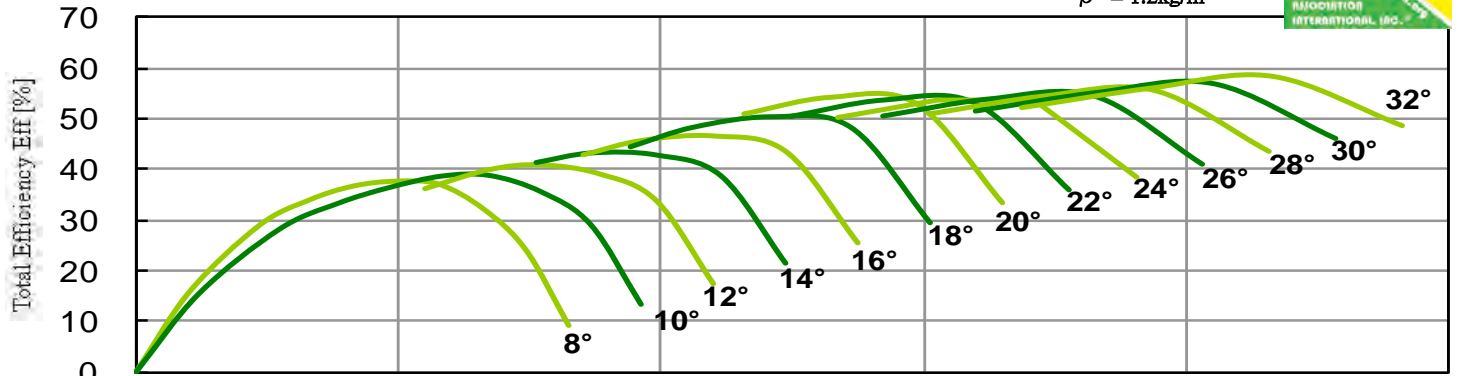

Performance certified is for installation type B: free inlet, ducted outlet. Performance ratings do not include the effects of appurtenances (accessories).

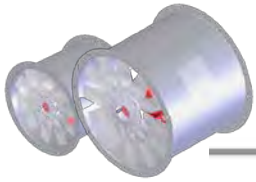

# Axial Fan Driven Directly



LASD-710-300-12 **50Hz** Performance curves



**FEG 60**

Fan Speed ; N = 1440 [RPM]    Outlet Area ; A = 0.3959 [m<sup>2</sup>]

$\rho = 1.2\text{kg/m}^3$

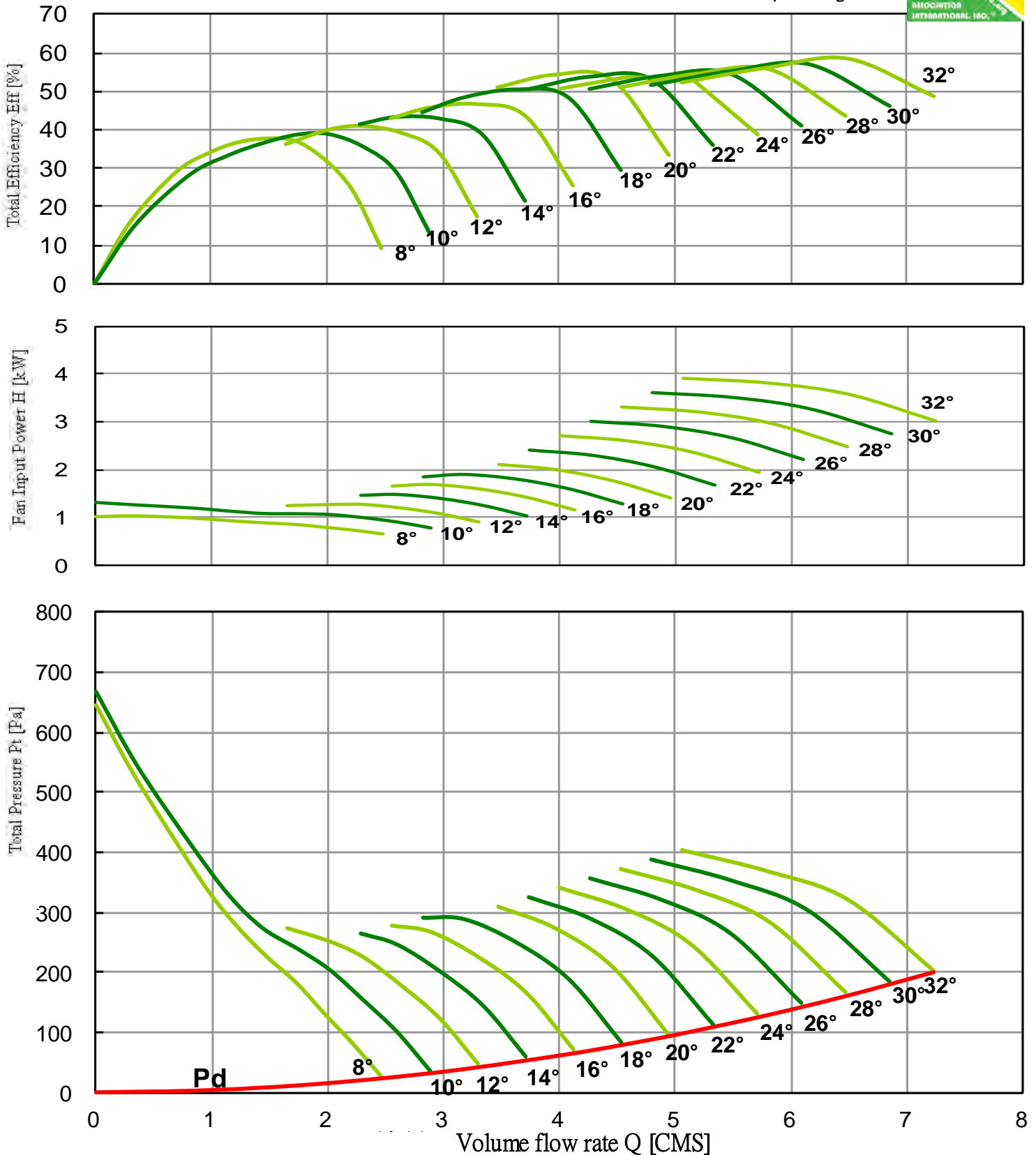

Performance certified is for installation type B: free inlet, ducted outlet. Performance ratings do not include the effects of appurtenances (accessories).



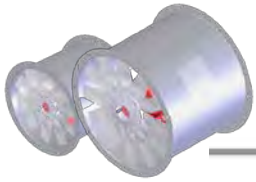

# Axial Fan Driven Directly



LASD-710-300-12 **50Hz** Performance curves



**FEG 60**

Fan Speed ; N = 2850 [RPM]    Outlet Area ; A = 0.3959 [m<sup>2</sup>]

$\rho = 1.2\text{kg/m}^3$

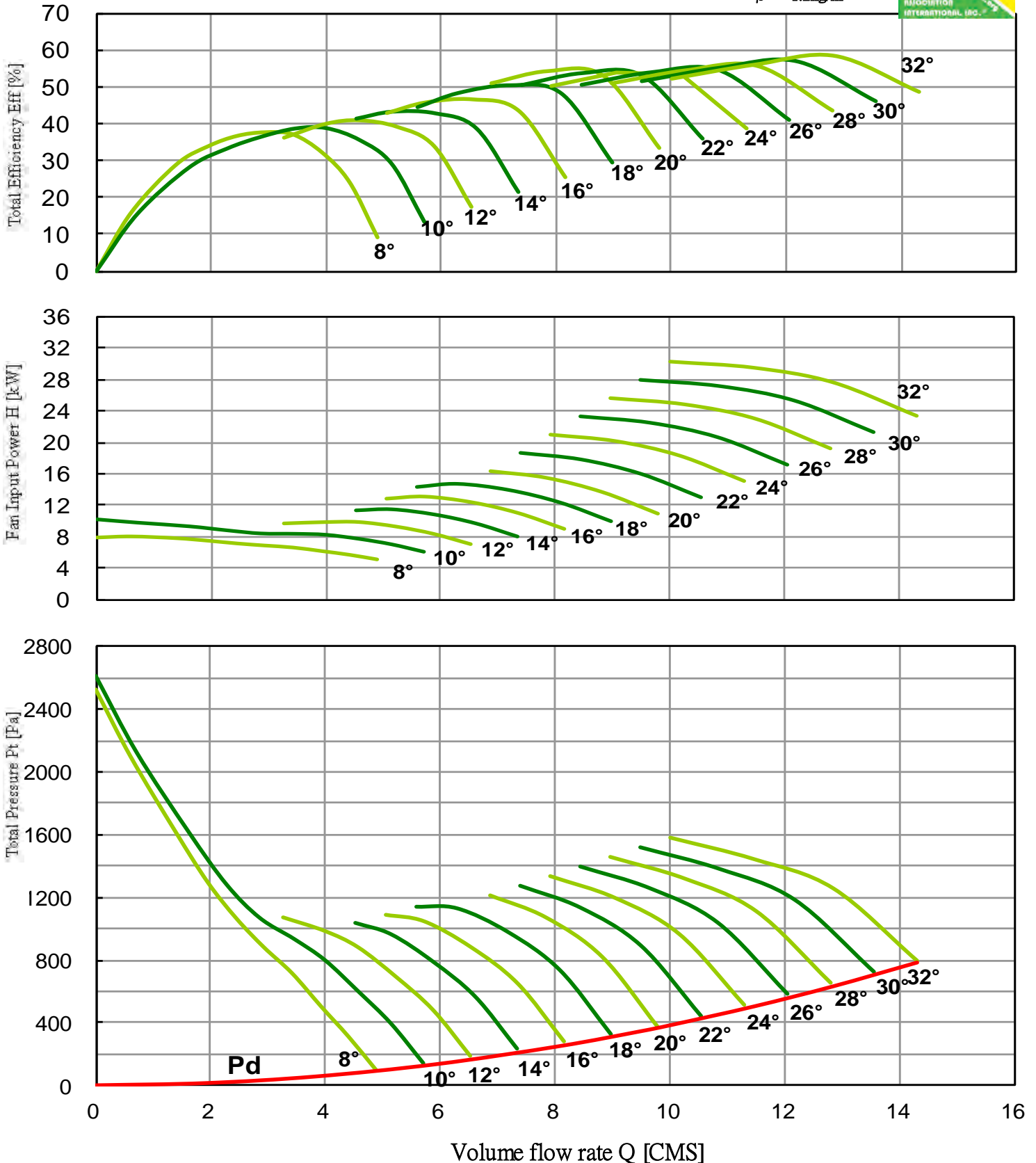

Performance certified is for installation type B: free inlet, ducted outlet. Performance ratings do not include the effects of appurtenances (accessories).

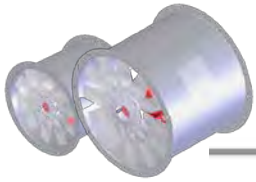

# Axial Fan Driven Directly



LASD-800-300-6 **50Hz** Performance curves



**FEG 67**

Fan Speed ;  $N = 720$  [RPM]    Outlet Area ;  $A = 0.5027$  [m<sup>2</sup>]

$\rho = 1.2\text{kg/m}^3$

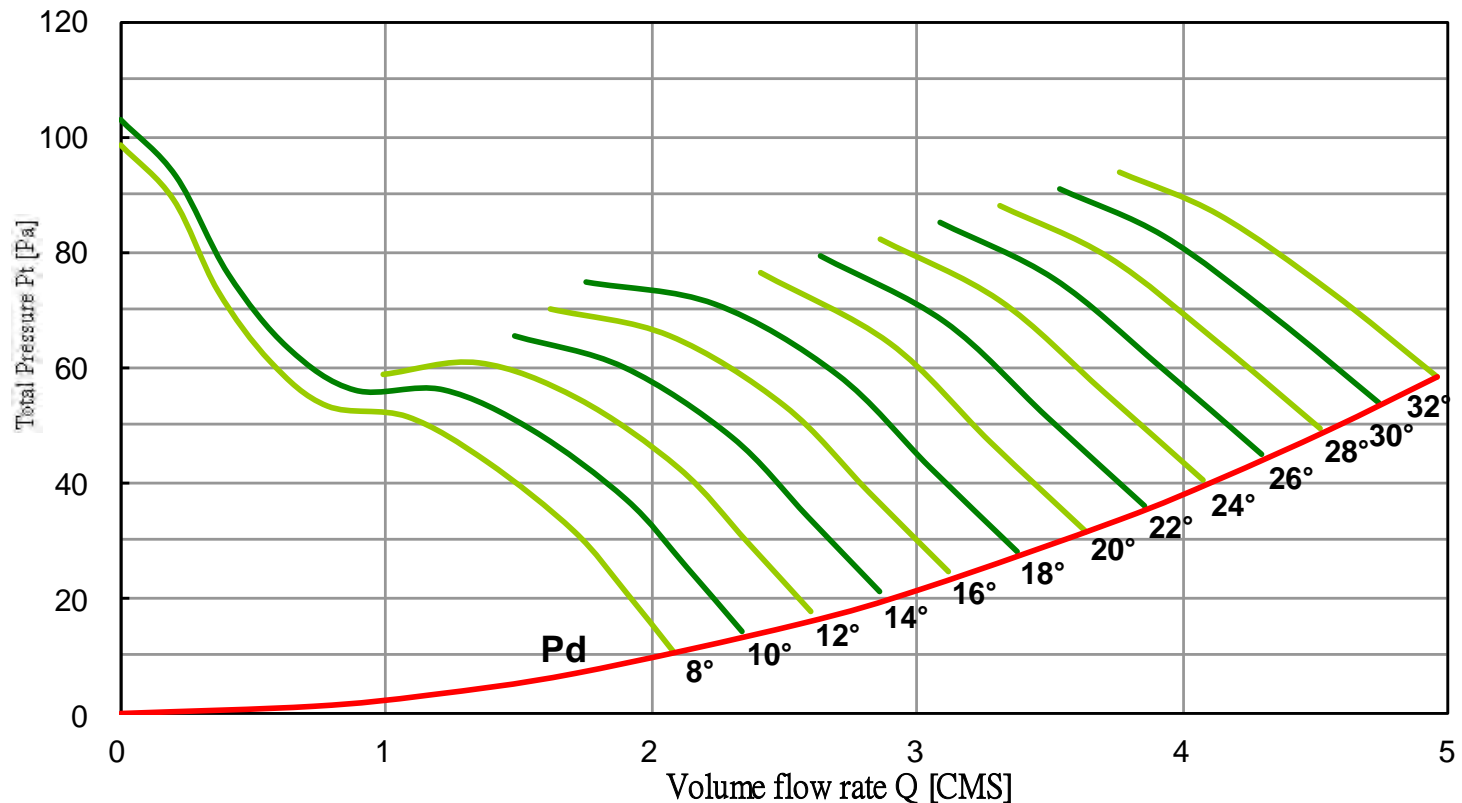
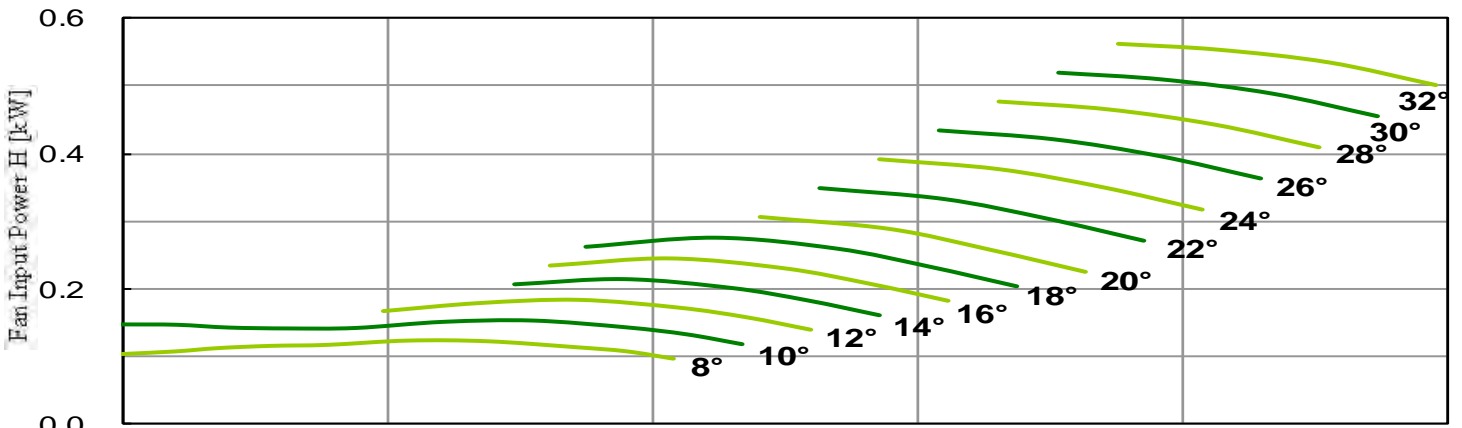
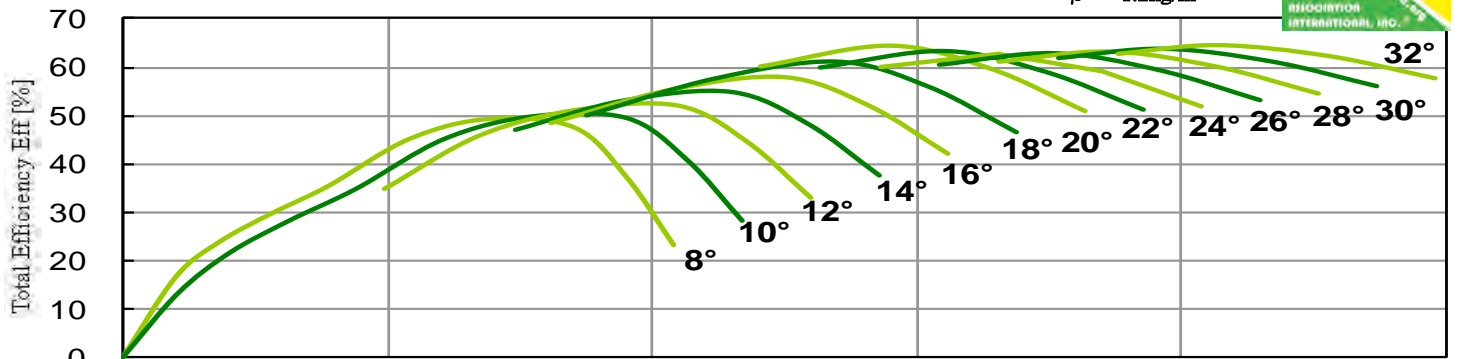

Performance certified is for installation type B: free inlet, ducted outlet. Performance ratings do not include the effects of appurtenances (accessories).



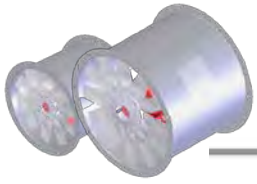

# Axial Fan Driven Directly



LASD-800-300-6 **50Hz** Performance curves



**FEG 67**

Fan Speed ; N = 960 [RPM] Outlet Area ; A = 0.5027 [m<sup>2</sup>]

$\rho = 1.2\text{kg/m}^3$

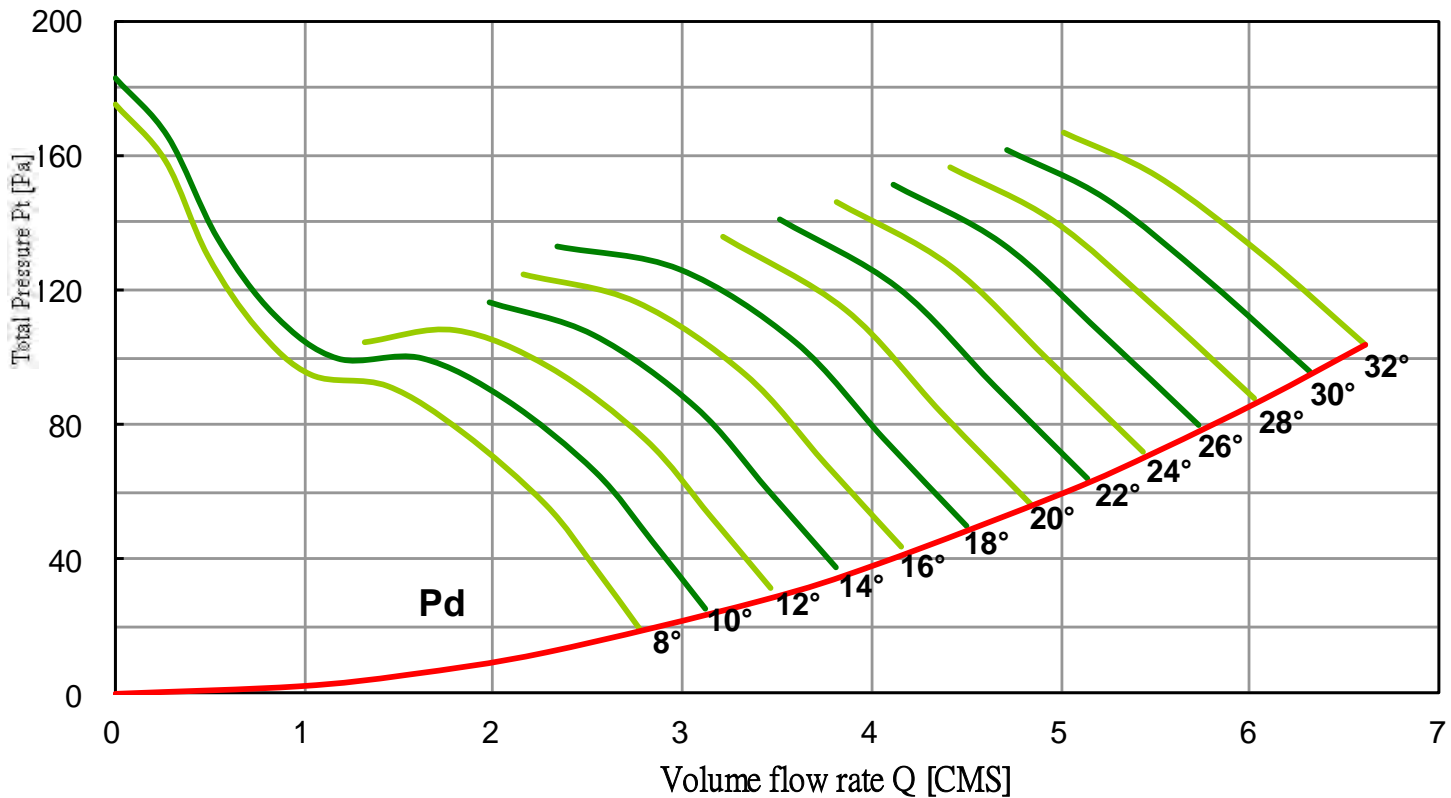
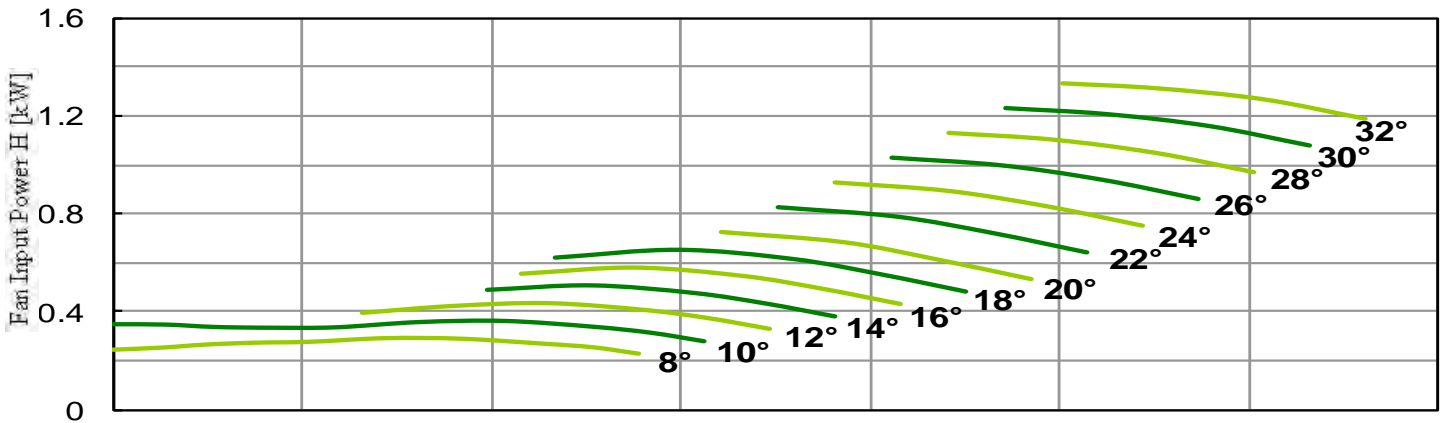
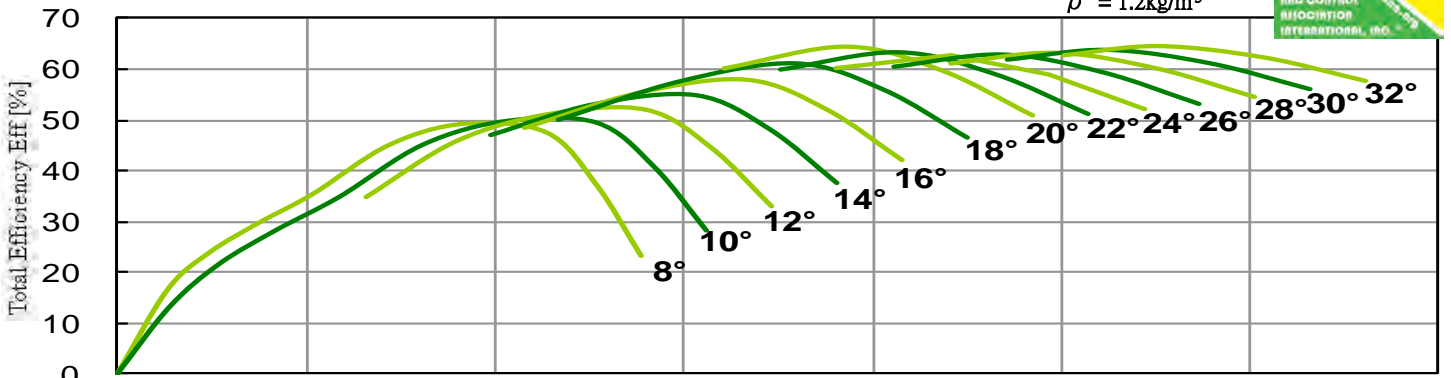

Performance certified is for installation type B: free inlet, ducted outlet. Performance ratings do not include the effects of appurtenances (accessories).

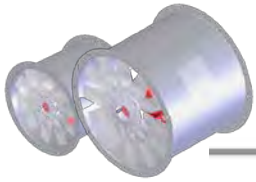

# Axial Fan Driven Directly



LASD-800-300-6 **50Hz** Performance curves



**FEG 67**

Fan Speed ; N = 1440 [RPM] Outlet Area ; A = 0.5027 [m<sup>2</sup>]

$\rho = 1.2\text{kg/m}^3$

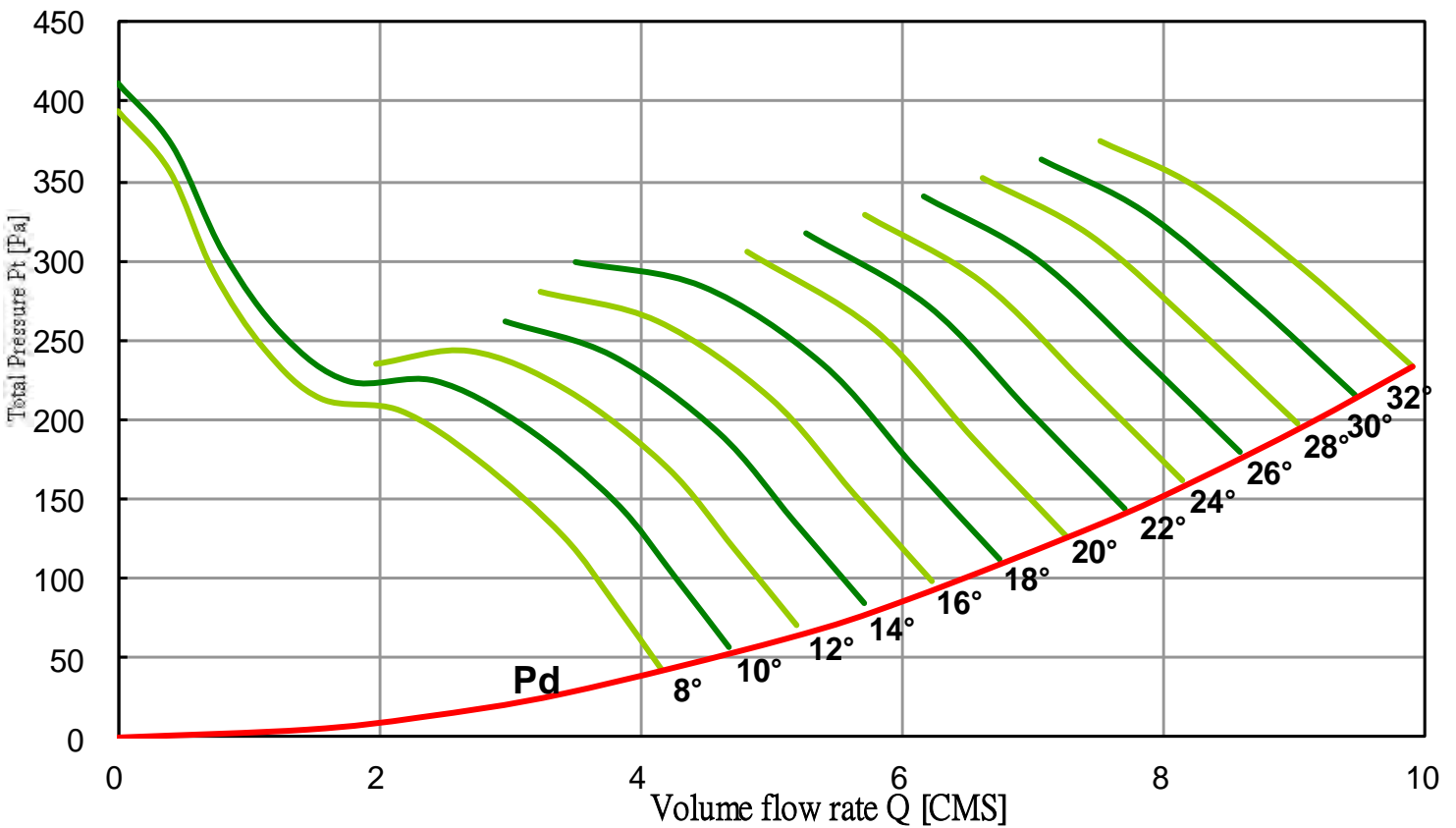
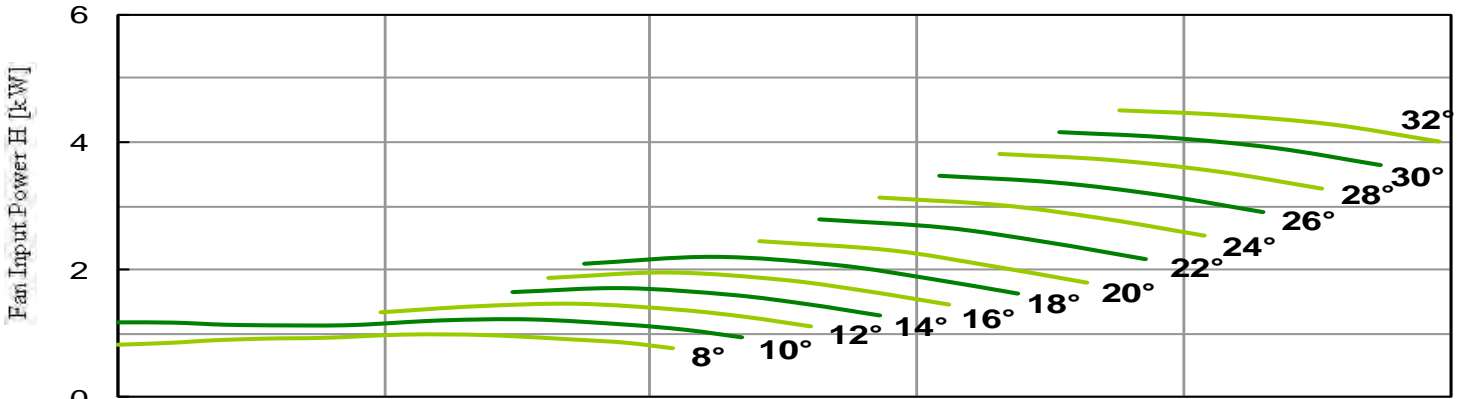
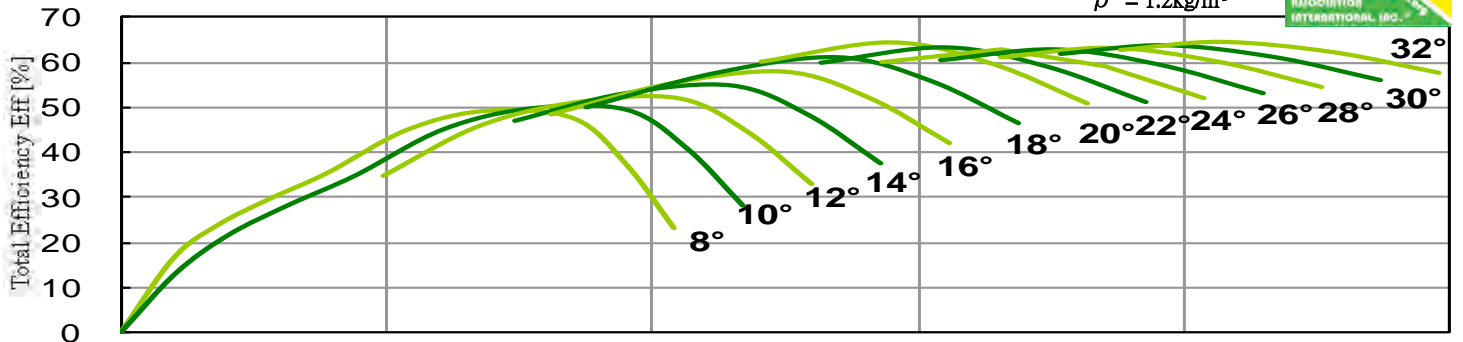

Performance certified is for installation type B: free inlet, ducted outlet. Performance ratings do not include the effects of appurtenances (accessories).

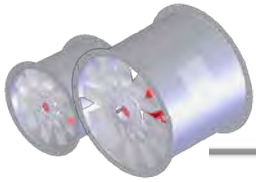

# Axial Fan Driven Directly



LASD-800-300-6 **50Hz** Performance curves

**FEG 67**

Fan Speed ; N = 2850 [RPM] Outlet Area ; A = 0.5027 [m<sup>2</sup>]



$\rho = 1.2 \text{ kg/m}^3$

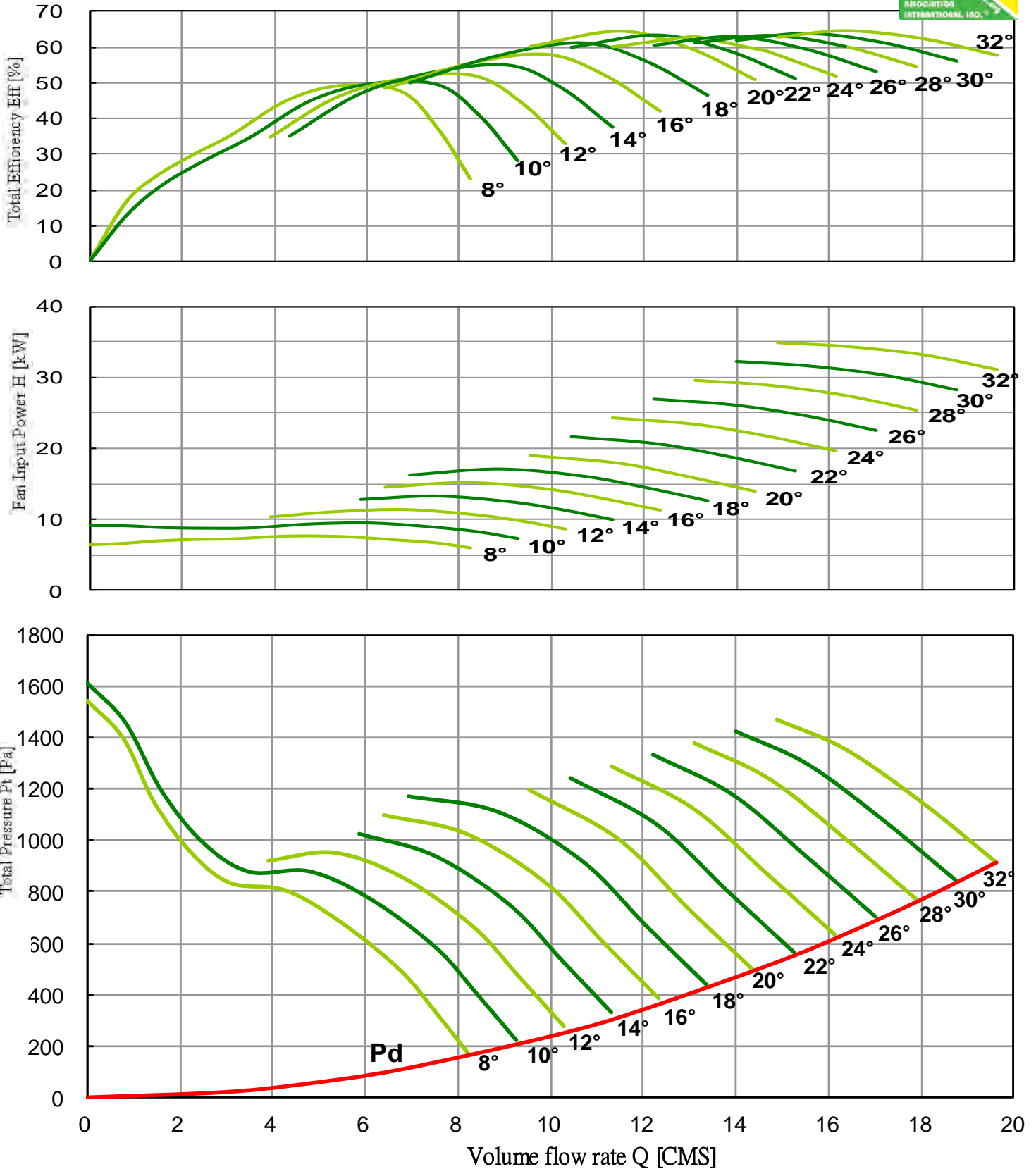

Performance certified is for installation type B: free inlet, ducted outlet. Performance ratings do not include the effects of appurtenances (accessories).

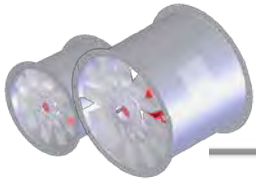

# Axial Fan Driven Directly



LASD-800-300-12 **50Hz**

Performance curves



**FEG 63**

Fan Speed ; N = 720 [RPM]

Outlet Area ; A = 0.5027 [m<sup>2</sup>]

$\rho = 1.2\text{kg/m}^3$

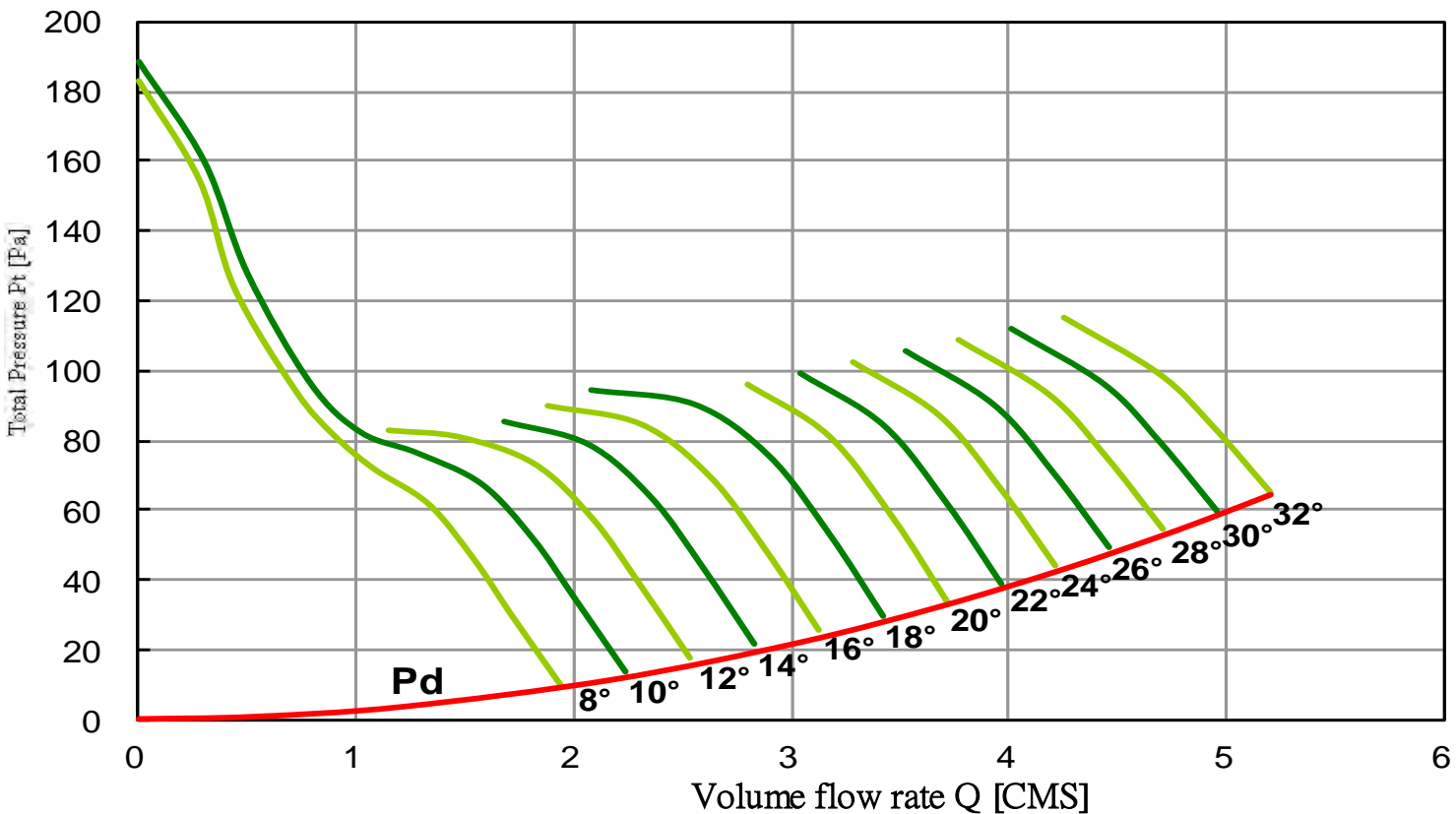
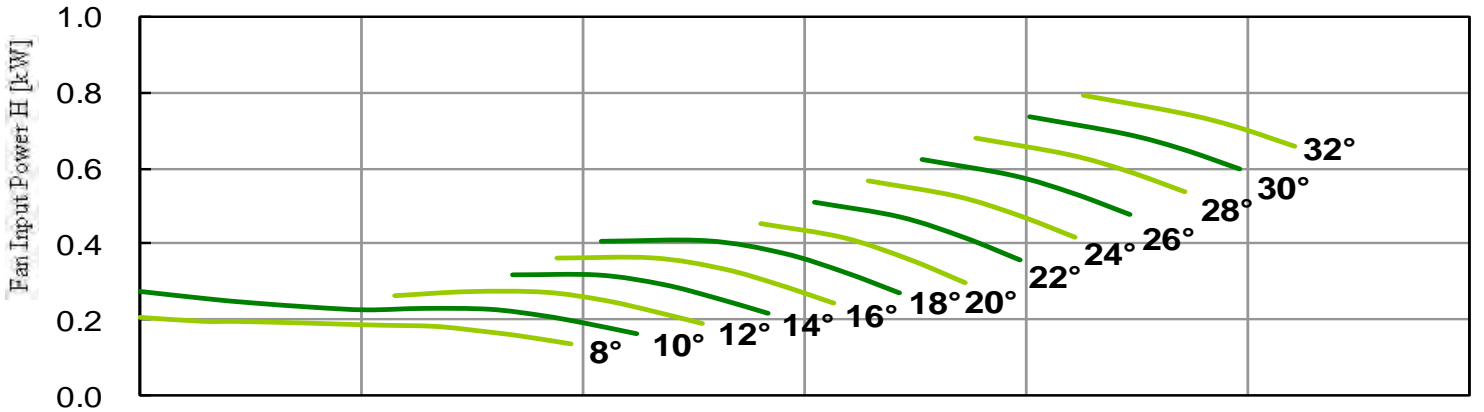
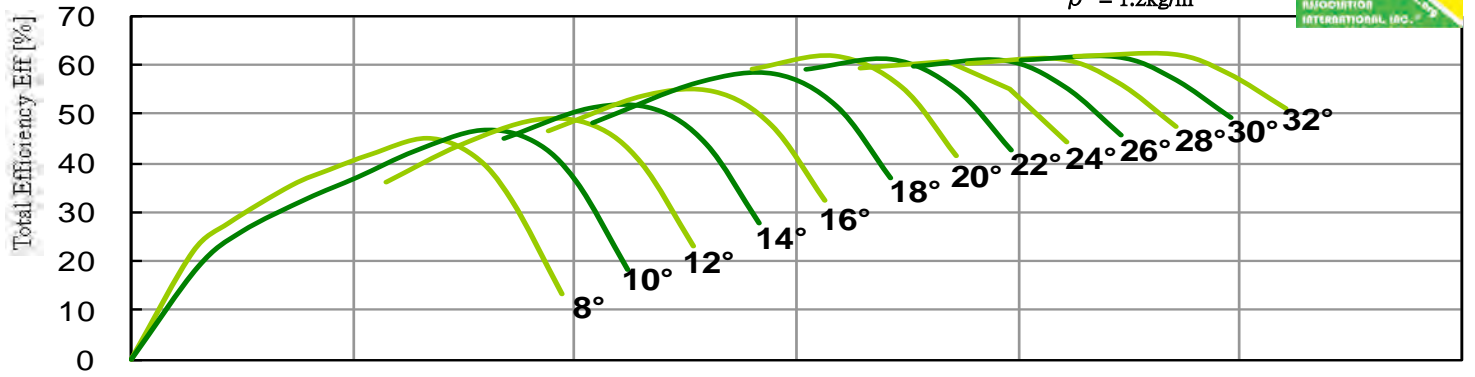

Performance certified is for installation type B: free inlet, ducted outlet. Performance ratings do not include the effects of appurtenances (accessories).

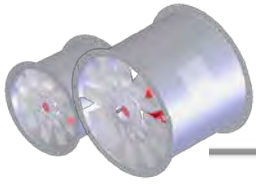

# Axial Fan Driven Directly



LASD-800-300-12 **50Hz** Performance curves



**FEG 63**

Fan Speed ; N = 960 [RPM] Outlet Area ; A = 0.5027 [m<sup>2</sup>]

$\rho = 1.2\text{kg/m}^3$

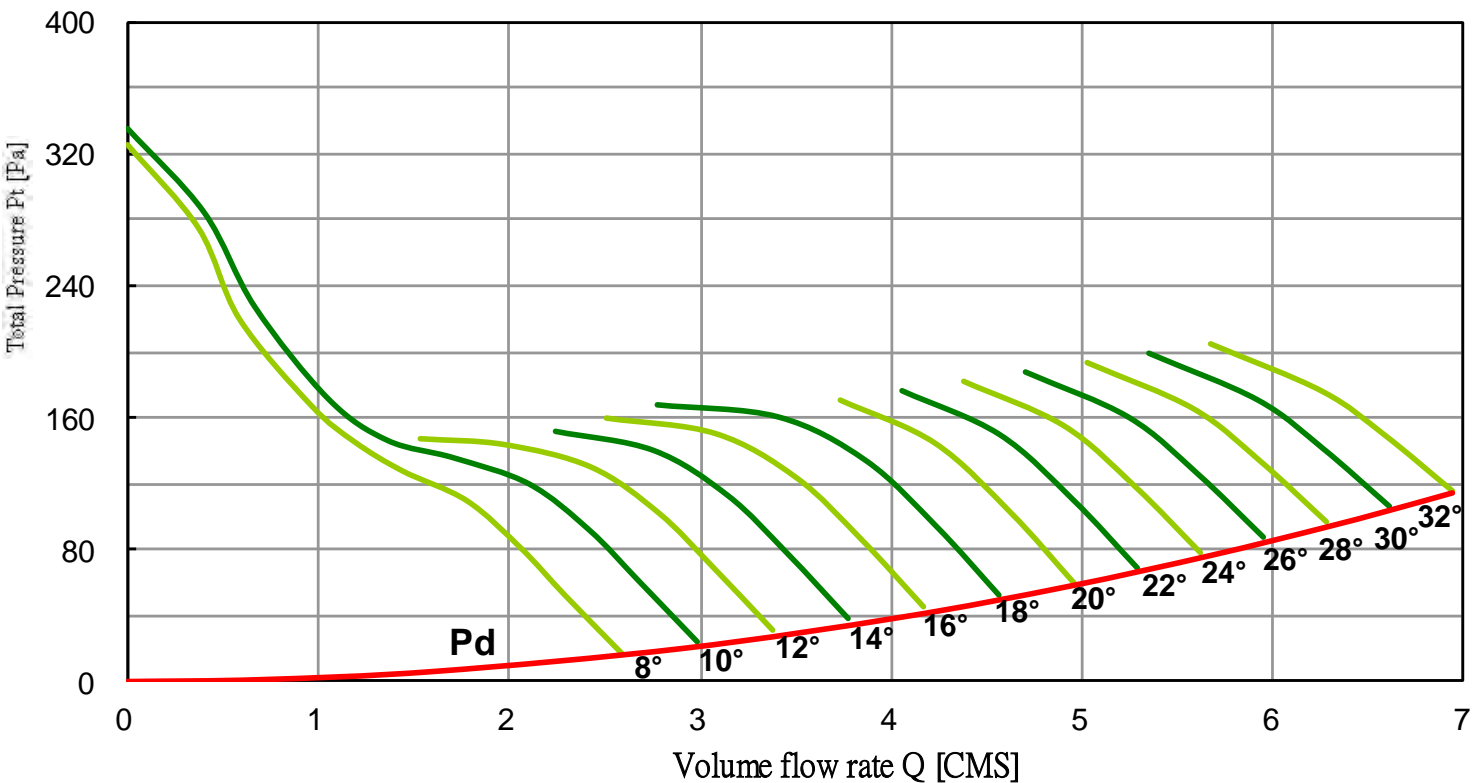
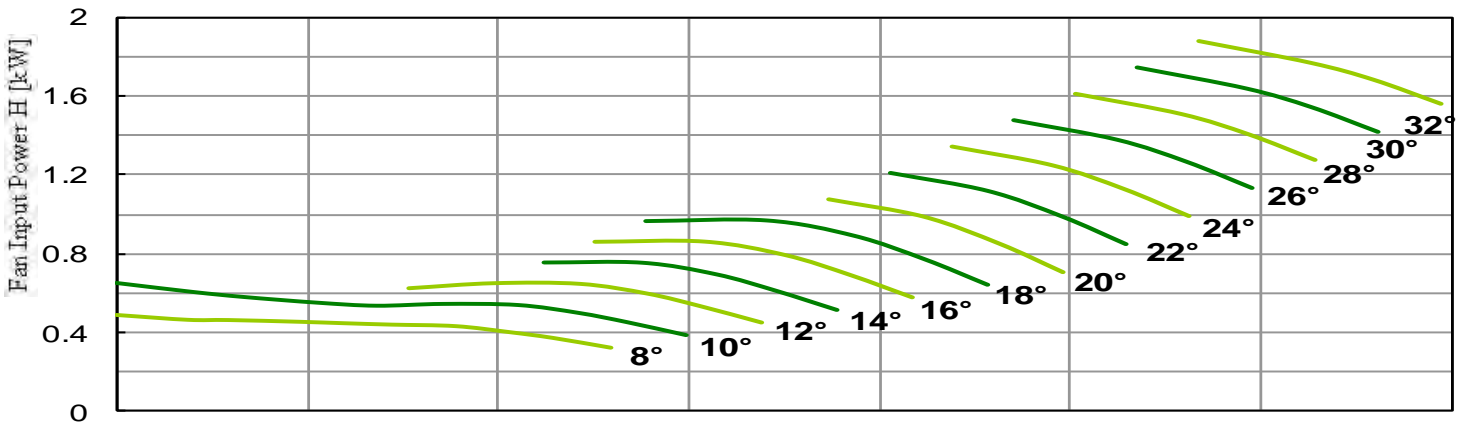
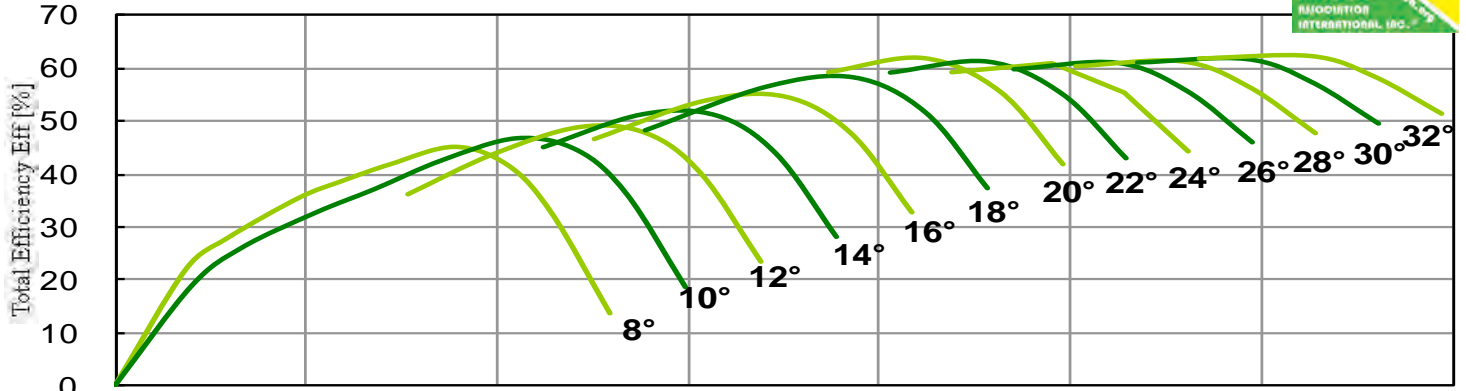

Performance certified is for installation type B: free inlet, ducted outlet. Performance ratings do not include the effects of appurtenances (accessories).

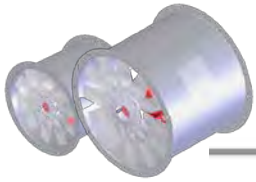

# Axial Fan Driven Directly



LASD-800-300-12 **50Hz** Performance curves



**FEG 63**

Fan Speed ;  $N = 1440$  [RPM]    Outlet Area ;  $A = 0.5027$  [m<sup>2</sup>]

$\rho = 1.2$ kg/m<sup>3</sup>

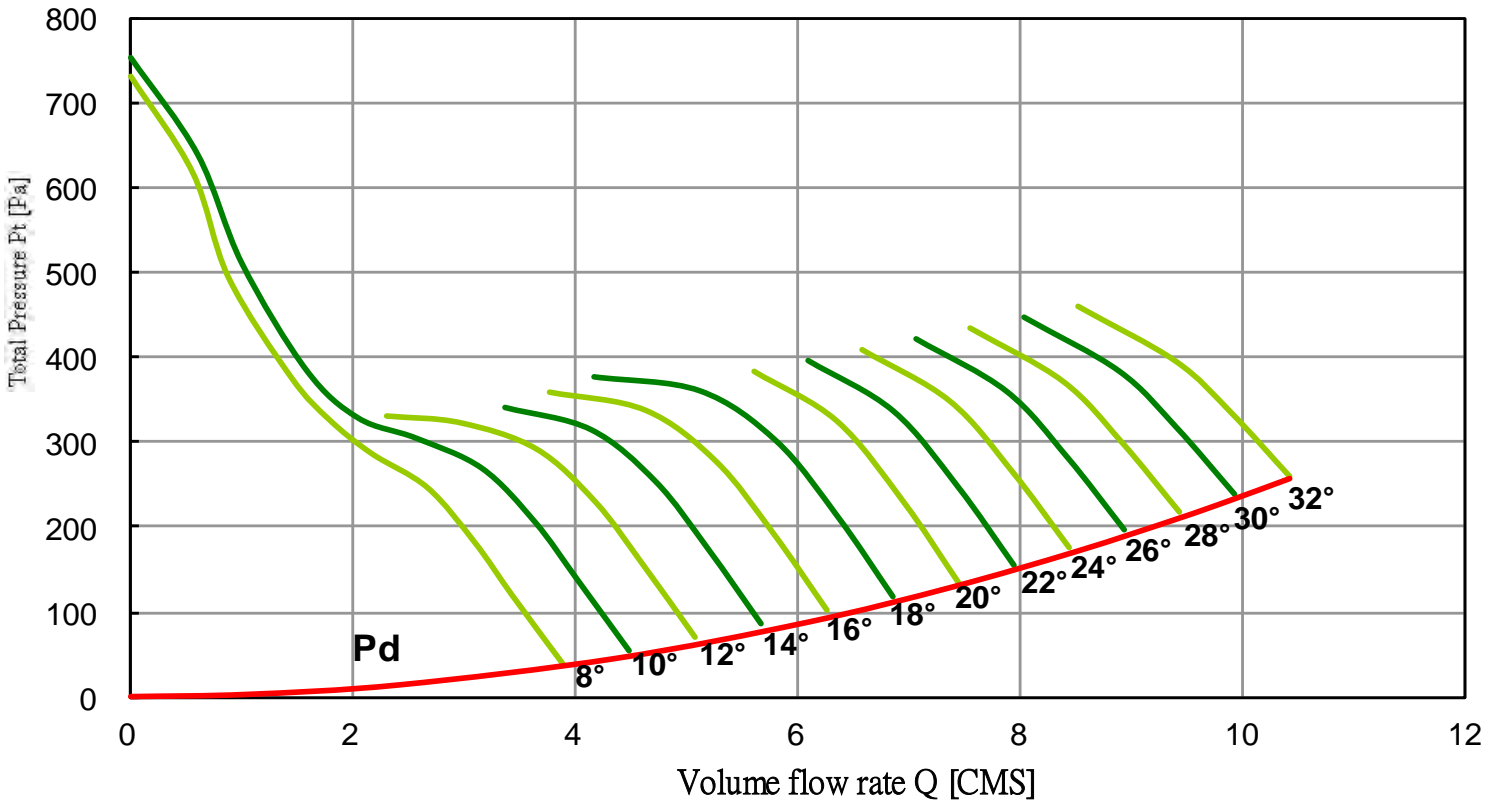
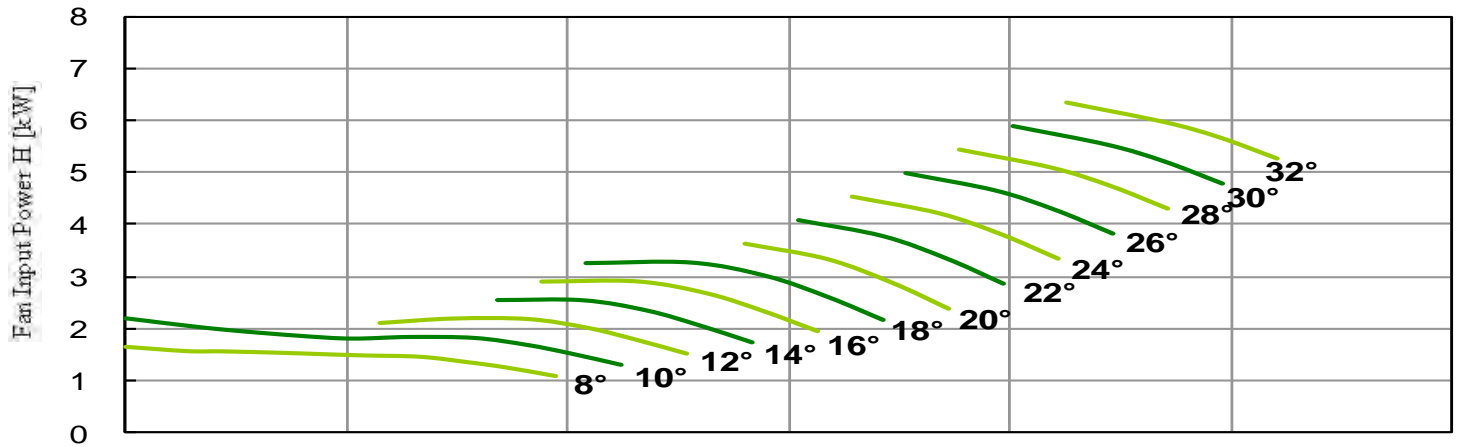
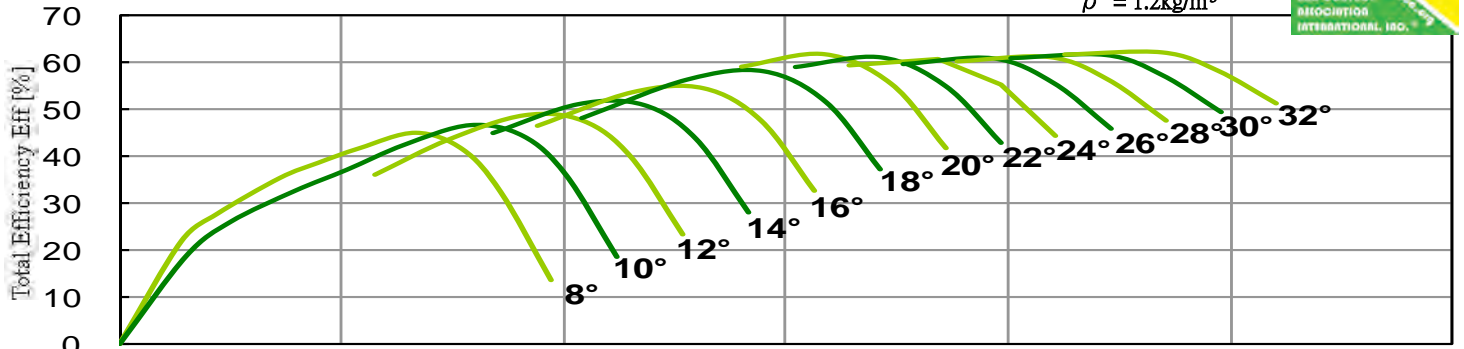

Performance certified is for installation type B: free inlet, ducted outlet. Performance ratings do not include the effects of appurtenances (accessories).



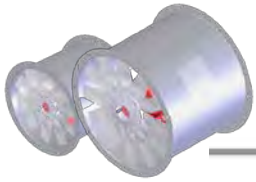

# Axial Fan Driven Directly



LASD-800-300-12 **50Hz** Performance curves



**FEG 63**

Fan Speed ; N = 2850 [RPM]    Outlet Area ; A = 0.5027 [m<sup>2</sup>]

$\rho = 1.2\text{kg/m}^3$

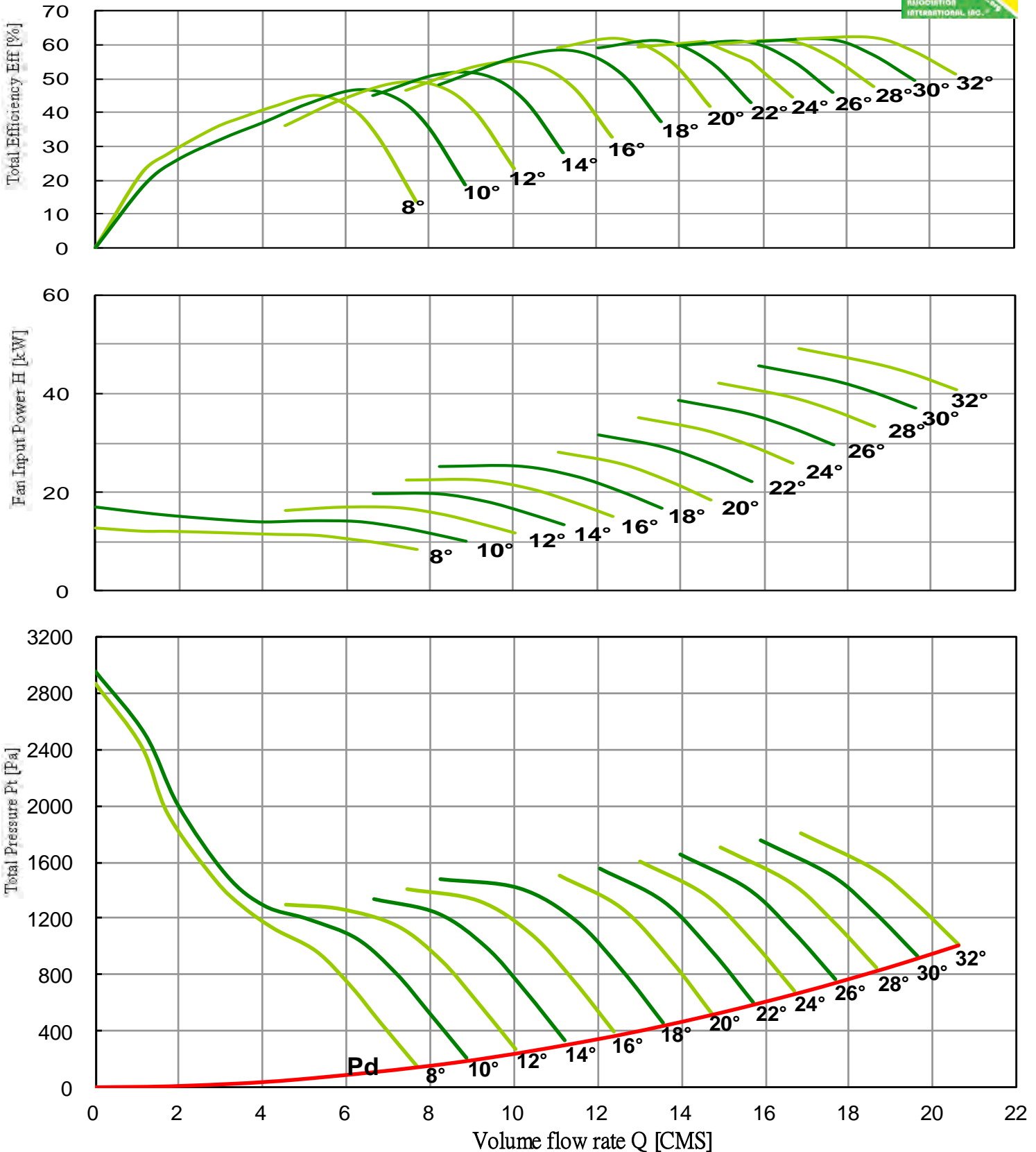

Performance certified is for installation type B: free inlet, ducted outlet. Performance ratings do not include the effects of appurtenances (accessories).

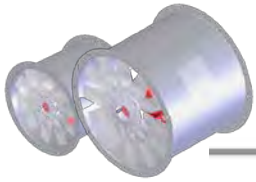

# Axial Fan Driven Directly



LASD-900-300-6 50Hz Performance curves



**FEG 67**

Fan Speed ;  $N = 720$  [RPM] Outlet Area ;  $A = 0.6362$  [m<sup>2</sup>]

$\rho = 1.2$ kg/m<sup>3</sup>

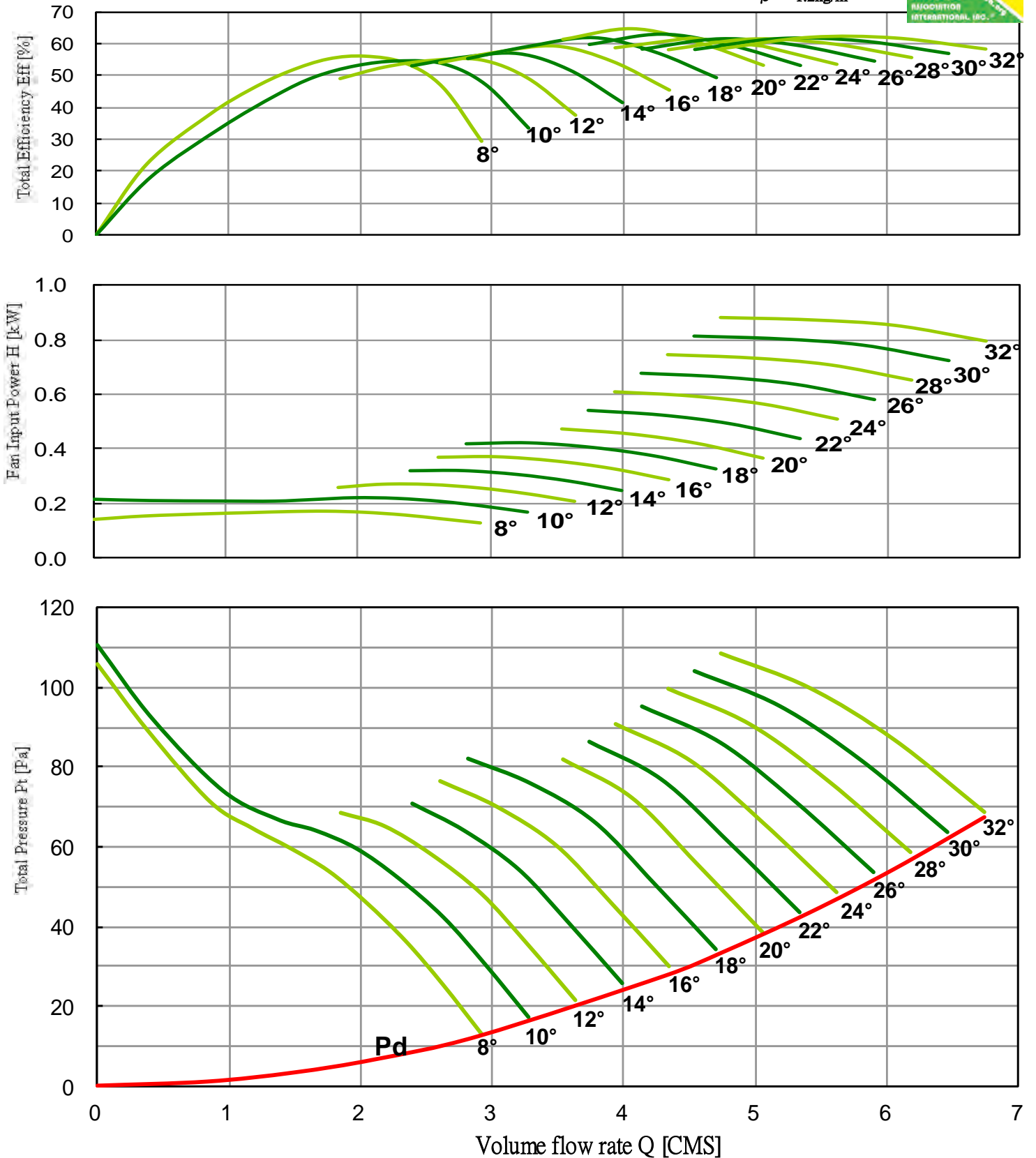

Performance certified is for installation type B: free inlet, ducted outlet. Performance ratings do not include the effects of appurtenances (accessories).



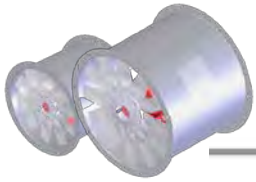

# Axial Fan Driven Directly



LASD-900-300-6 **50Hz** Performance curves



**FEG 67**

Fan Speed :  $N = 960$  [RPM]    Outlet Area :  $A = 0.6362$  [m<sup>2</sup>]

$\rho = 1.2\text{kg/m}^3$

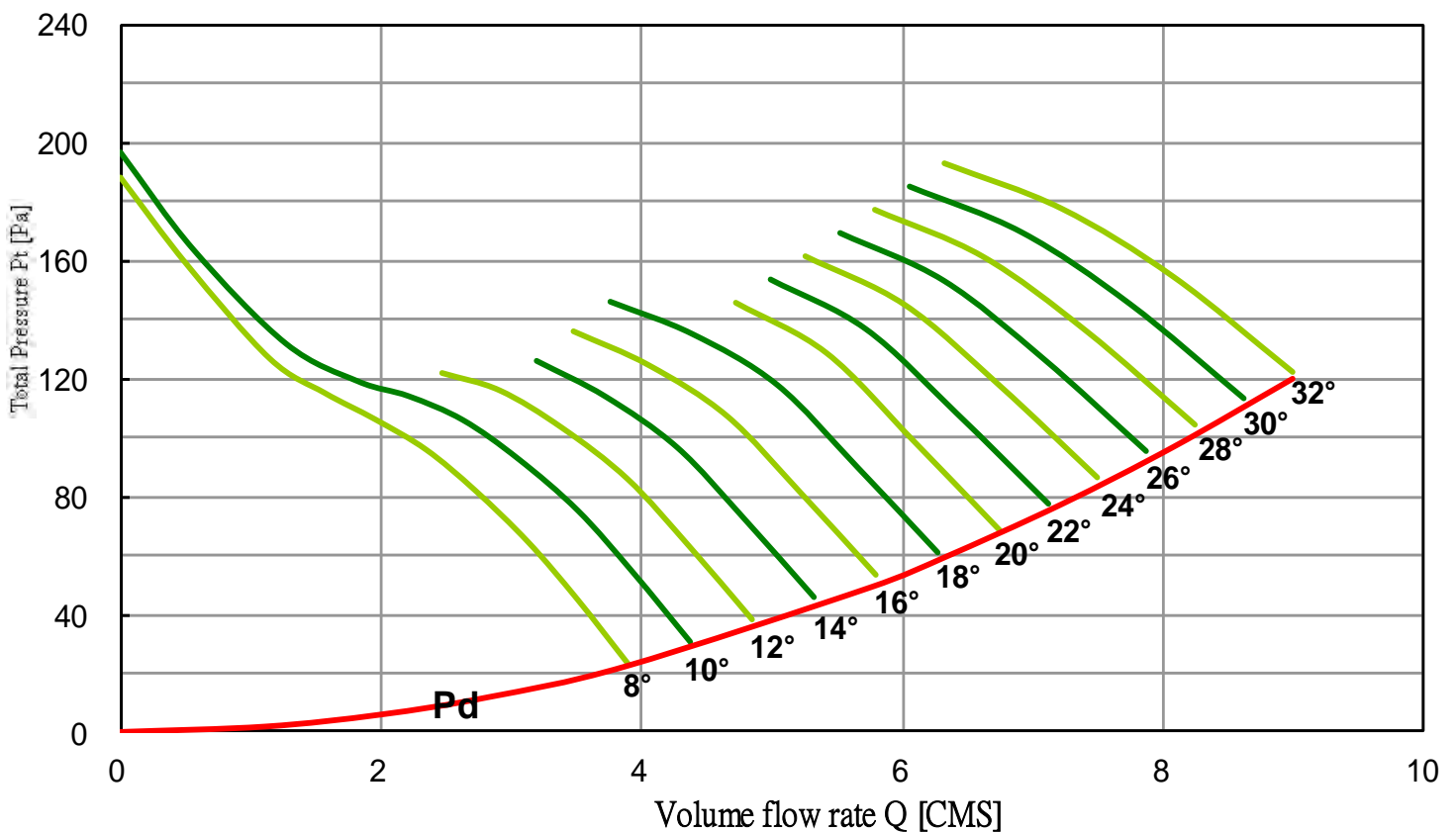
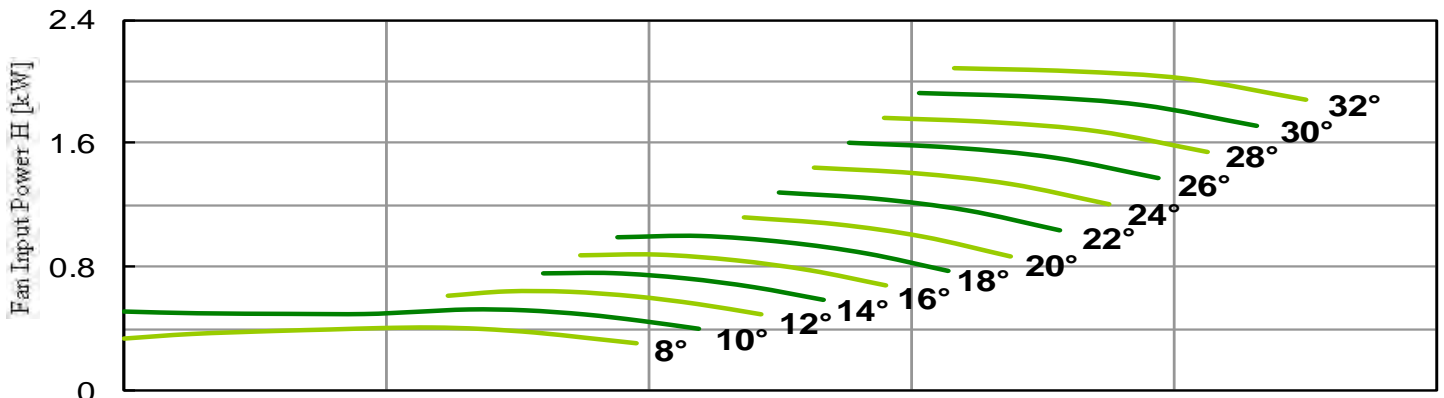
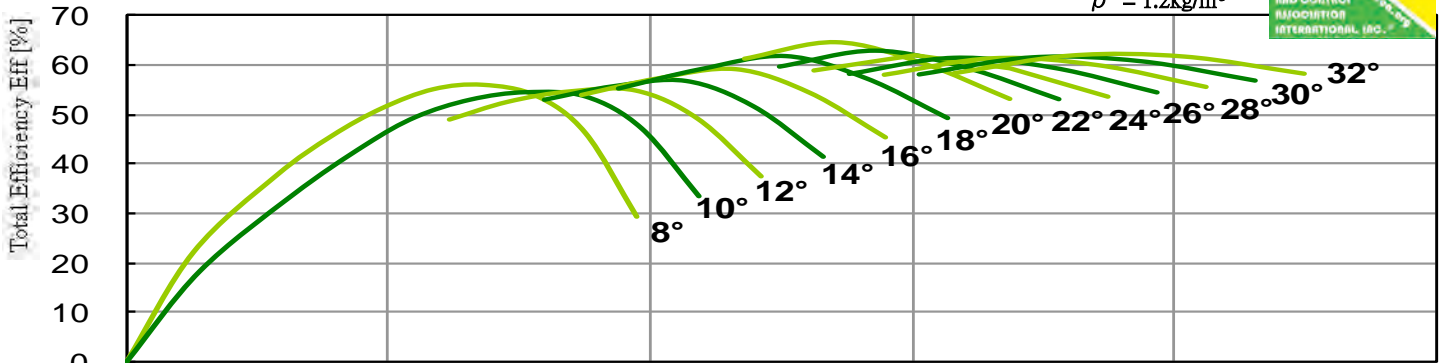

Performance certified is for installation type B: free inlet, ducted outlet. Performance ratings do not include the effects of appurtenances (accessories).

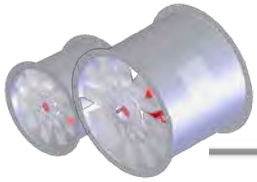

# Axial Fan Driven Directly



LASD-900-300-6 50Hz Performance curves



**FEG 60**

Fan Speed ;  $N = 1440$  [RPM]    Outlet Area ;  $A = 0.6362$  [m<sup>2</sup>]

$\rho = 1.2\text{kg/m}^3$

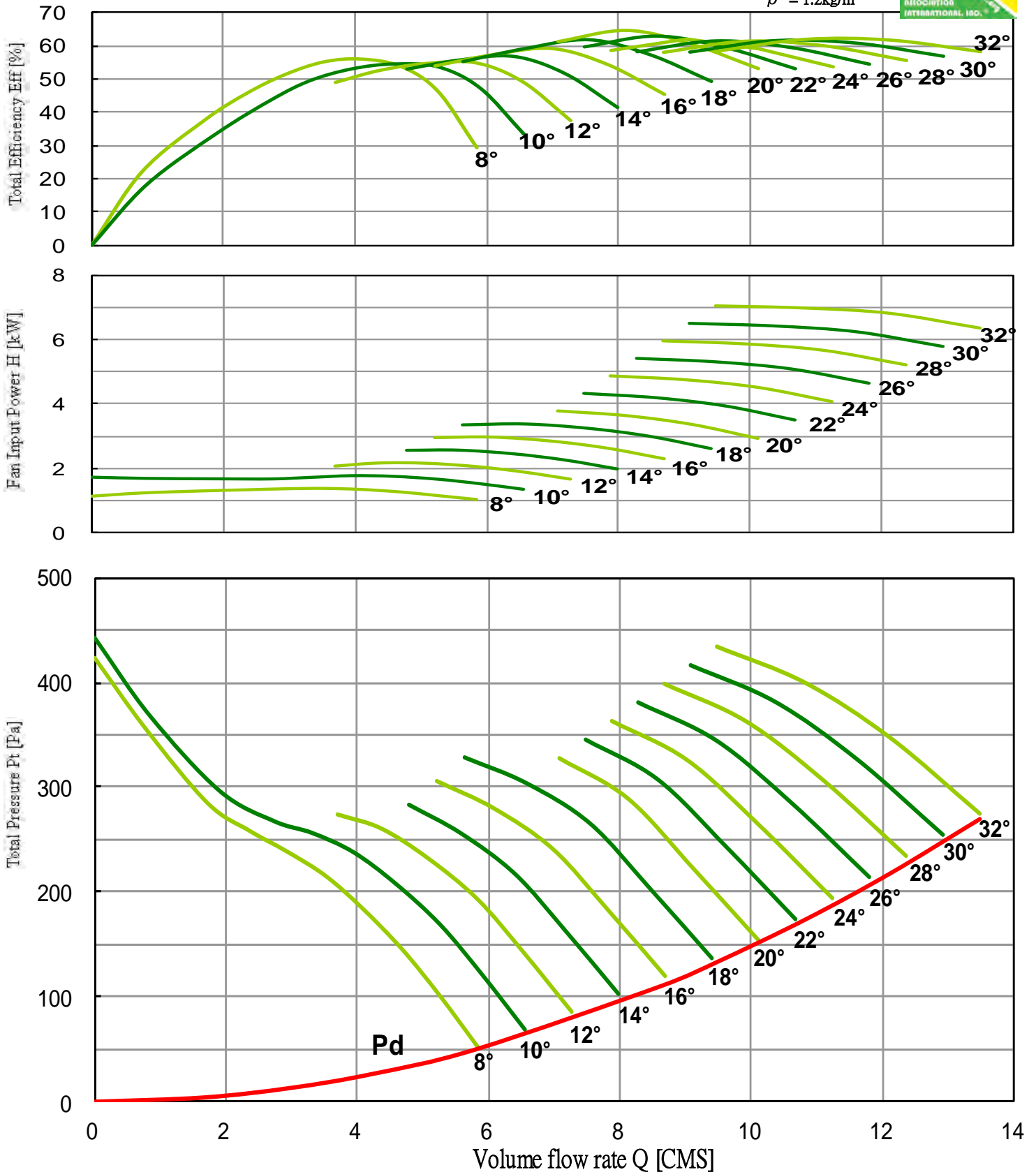

Performance certified is for installation type B: free inlet, ducted outlet. Performance ratings do not include the effects of appurtenances (accessories).

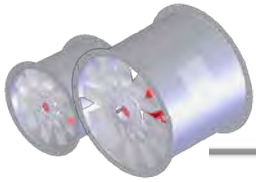

# Axial Fan Driven Directly



LASD-900-300-12 **50Hz** Performance curves



**FEG 67**

Fan Speed ; N = 720 [RPM] Outlet Area ; A = 0.6362 [m<sup>2</sup>]

$\rho = 1.2\text{kg/m}^3$

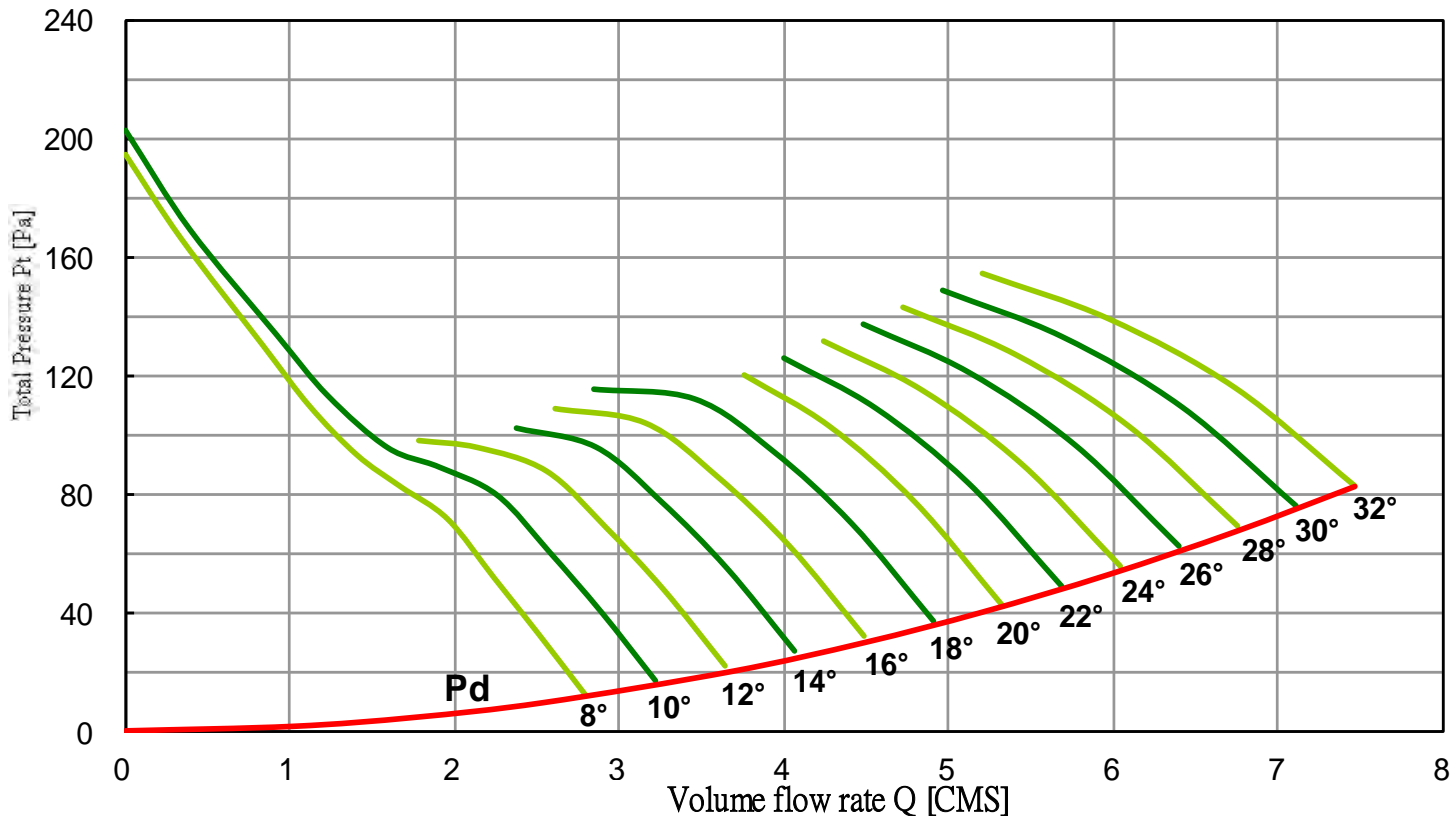
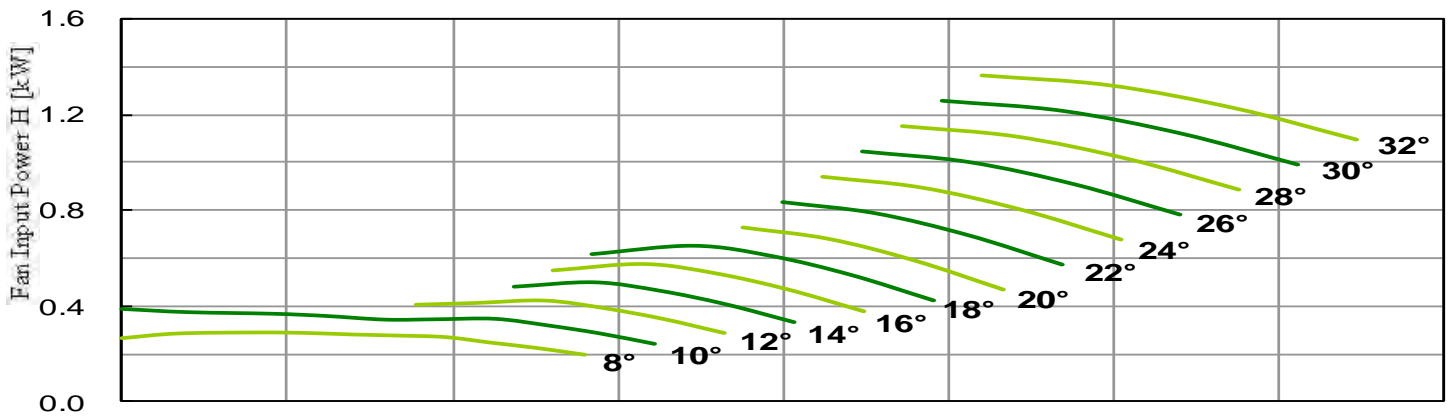
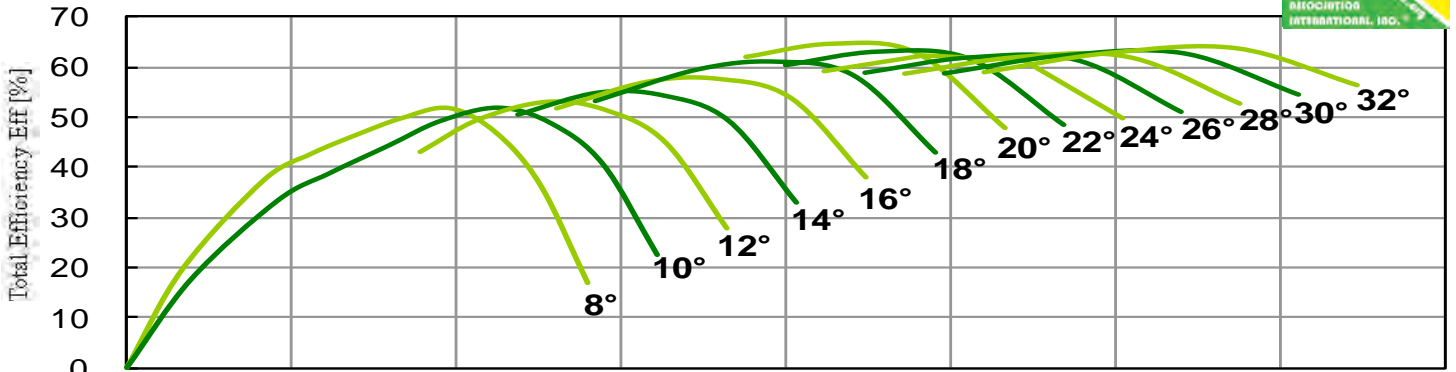

Performance certified is for installation type B: free inlet, ducted outlet. Performance ratings do not include the effects of appurtenances (accessories).

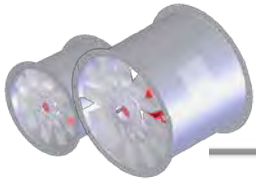

# Axial Fan Driven Directly



LASD-900-300-12 **50Hz** Performance curves



**FEG 67**

Fan Speed ;  $N = 960$  [RPM]    Outlet Area ;  $A = 0.6362$  [m<sup>2</sup>]

$\rho = 1.2\text{kg/m}^3$

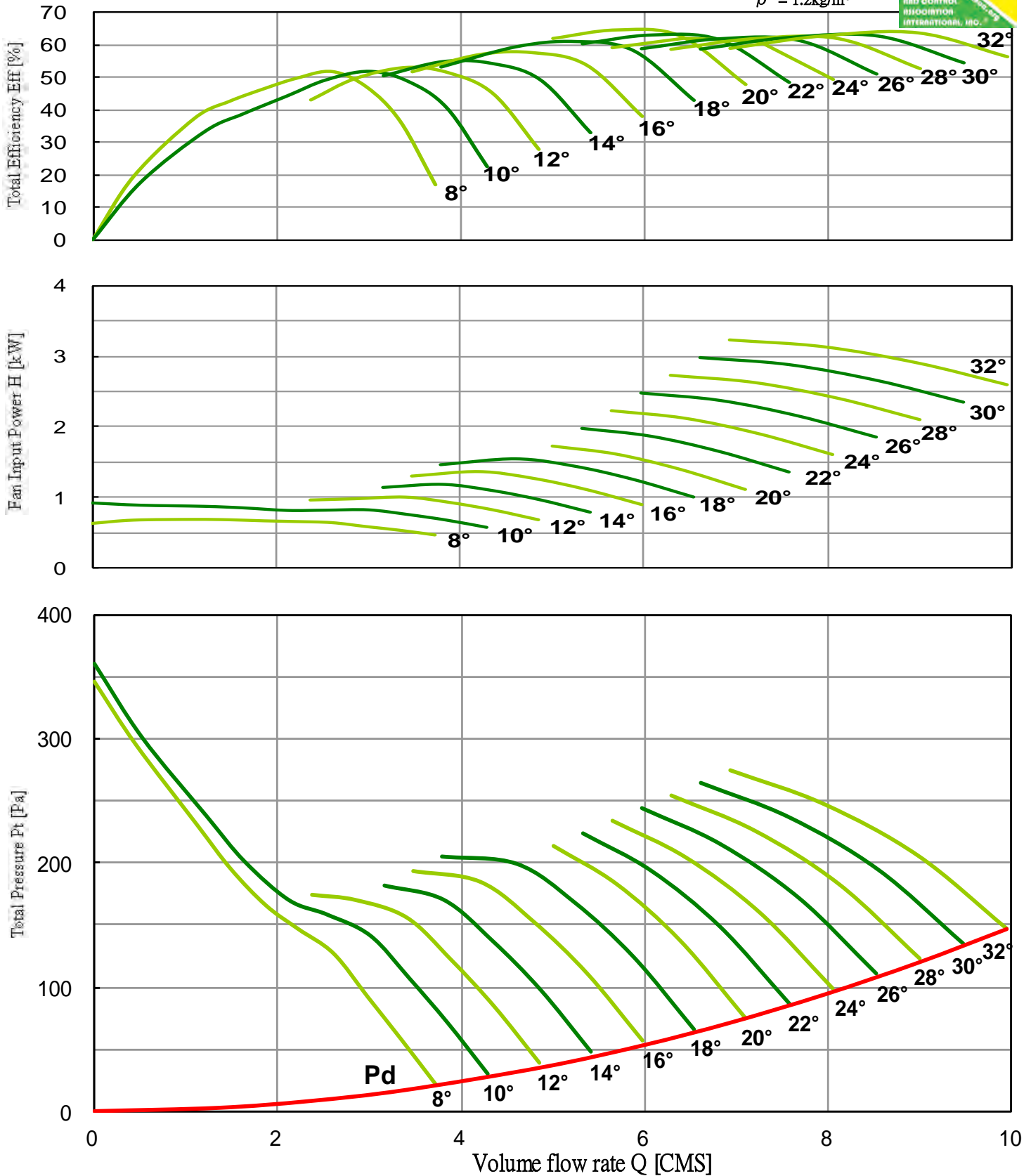

Performance certified is for installation type B: free inlet, ducted outlet. Performance ratings do not include the effects of appurtenances (accessories).

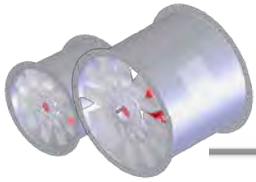

# Axial Fan Driven Directly



LASD-900-300-12 **50Hz** Performance curves

**FEG 67**

Fan Speed ; N = 1440 [RPM] Outlet Area ; A = 0.6362 [m<sup>2</sup>]

$\rho = 1.2\text{kg/m}^3$

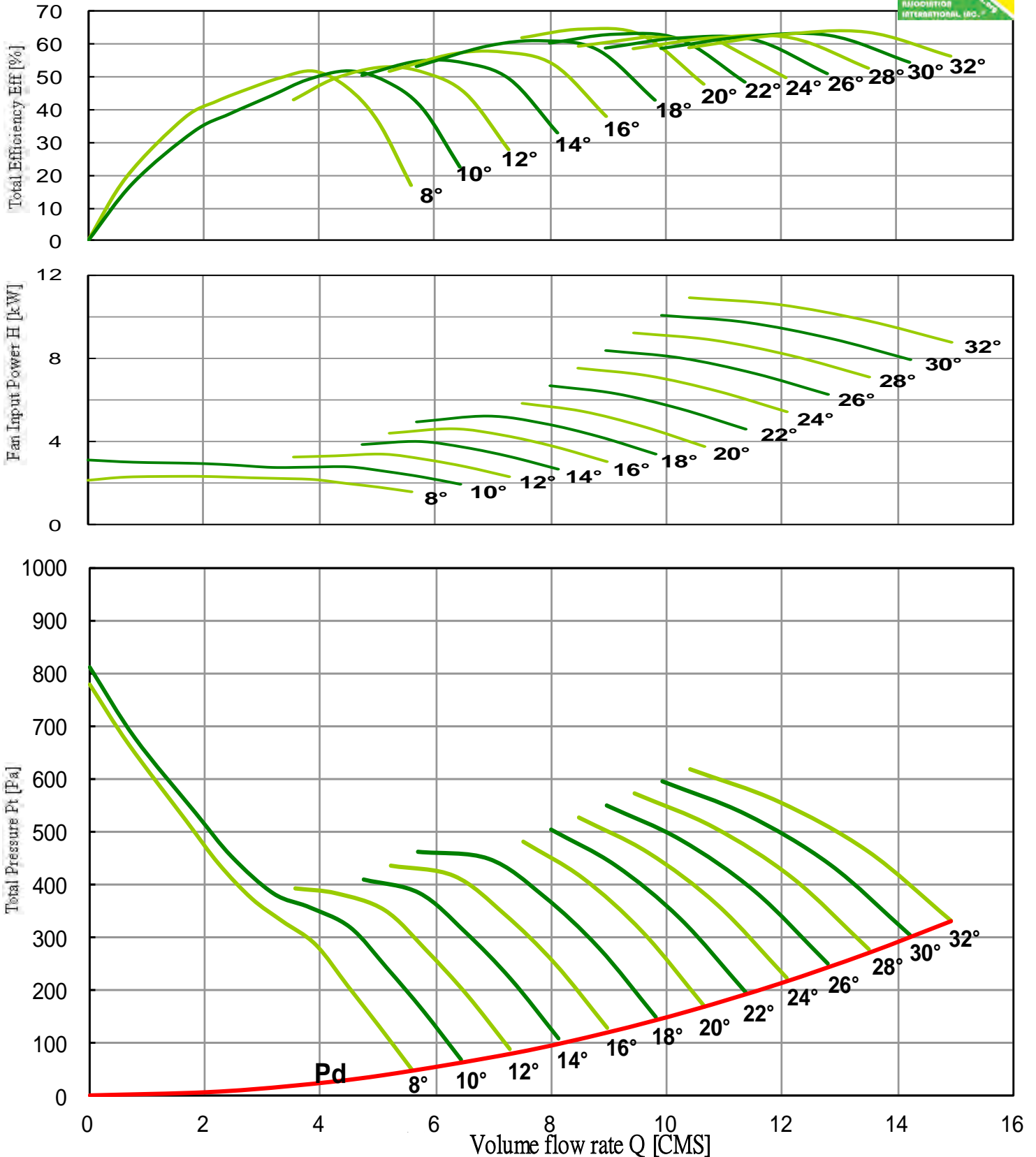

Performance certified is for installation type B: free inlet, ducted outlet. Performance ratings do not include the effects of appurtenances (accessories).



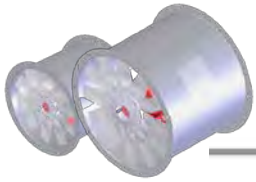

# Axial Fan Driven Directly



LASD-1000-300-6 **50Hz** Performance curves

**FEG 71**

Fan Speed ; N = 720 [RPM] Outlet Area ; A = 0.7933 [m<sup>2</sup>]

$\rho = 1.2\text{kg/m}^3$

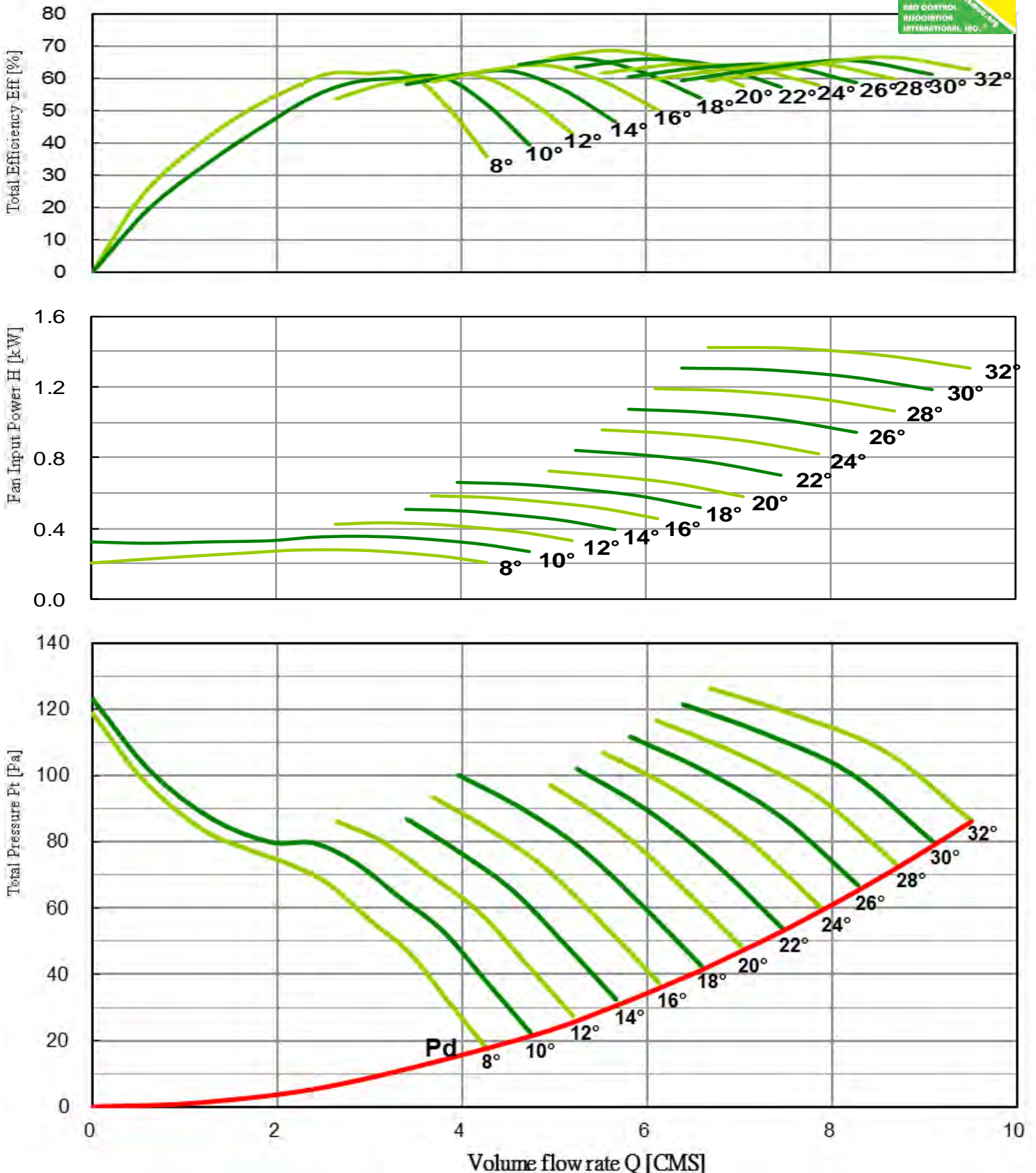

Performance certified is for installation type B: free inlet, ducted outlet. Performance ratings do not include the effects of appurtenances (accessories).

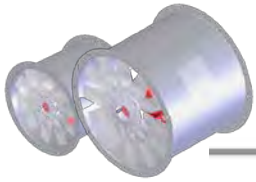

# Axial Fan Driven Directly



LASD-1000-300-6 **50Hz** Performance curves

**FEG 71**

Fan Speed ; N = 960 [RPM] Outlet Area ; A = 0.7933 [m<sup>2</sup>]



$\rho = 1.2 \text{ kg/m}^3$

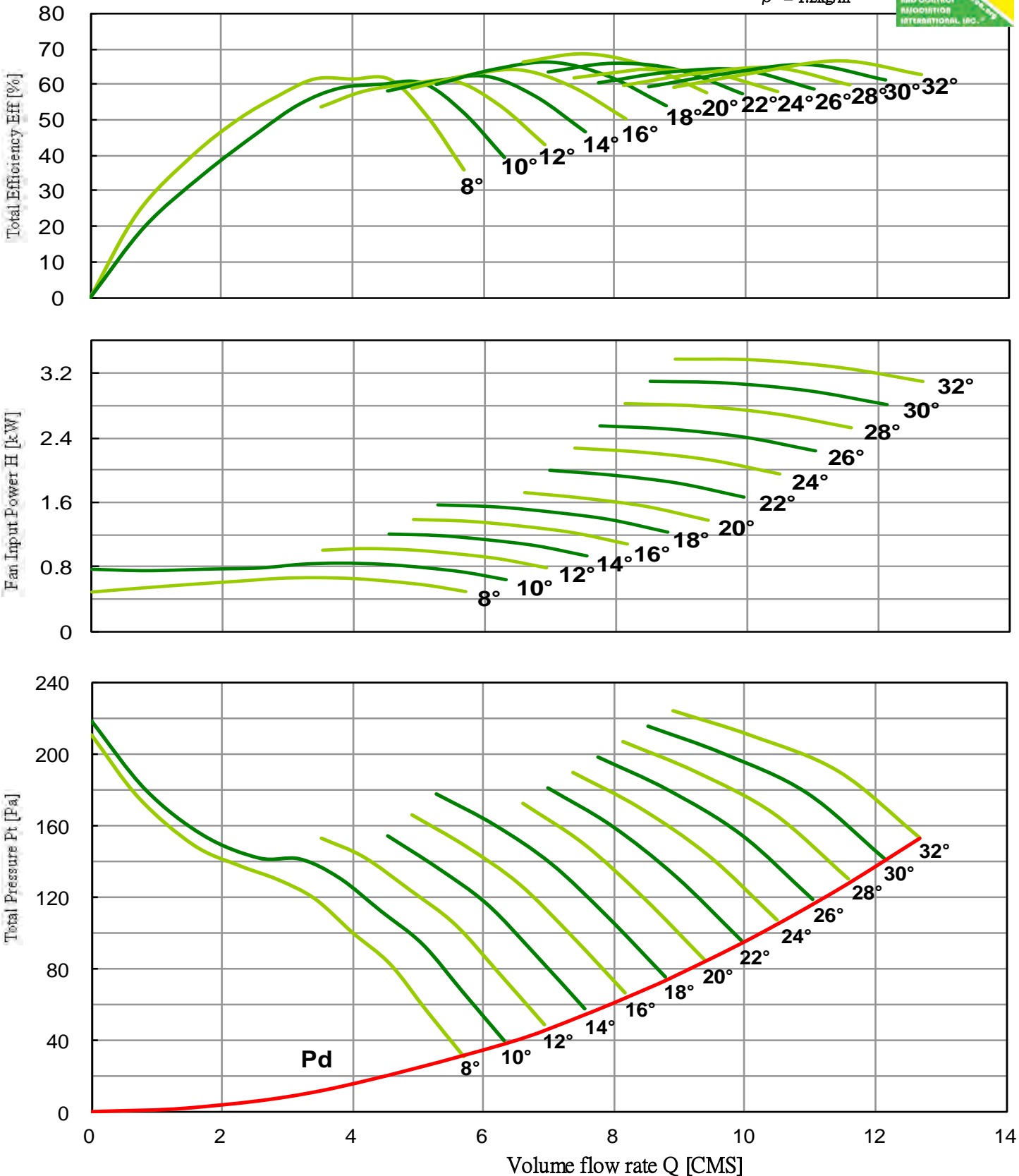

Performance certified is for installation type B: free inlet, ducted outlet. Performance ratings do not include the effects of appurtenances (accessories).



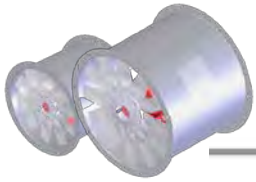

# Axial Fan Driven Directly



LASD-1000-300-6 **50Hz**

Performance curves



**FEG 71**

Fan Speed ; N = 1440 [RPM]

Outlet Area ; A = 0.7933 [m<sup>2</sup>]

$\rho = 1.2\text{kg/m}^3$

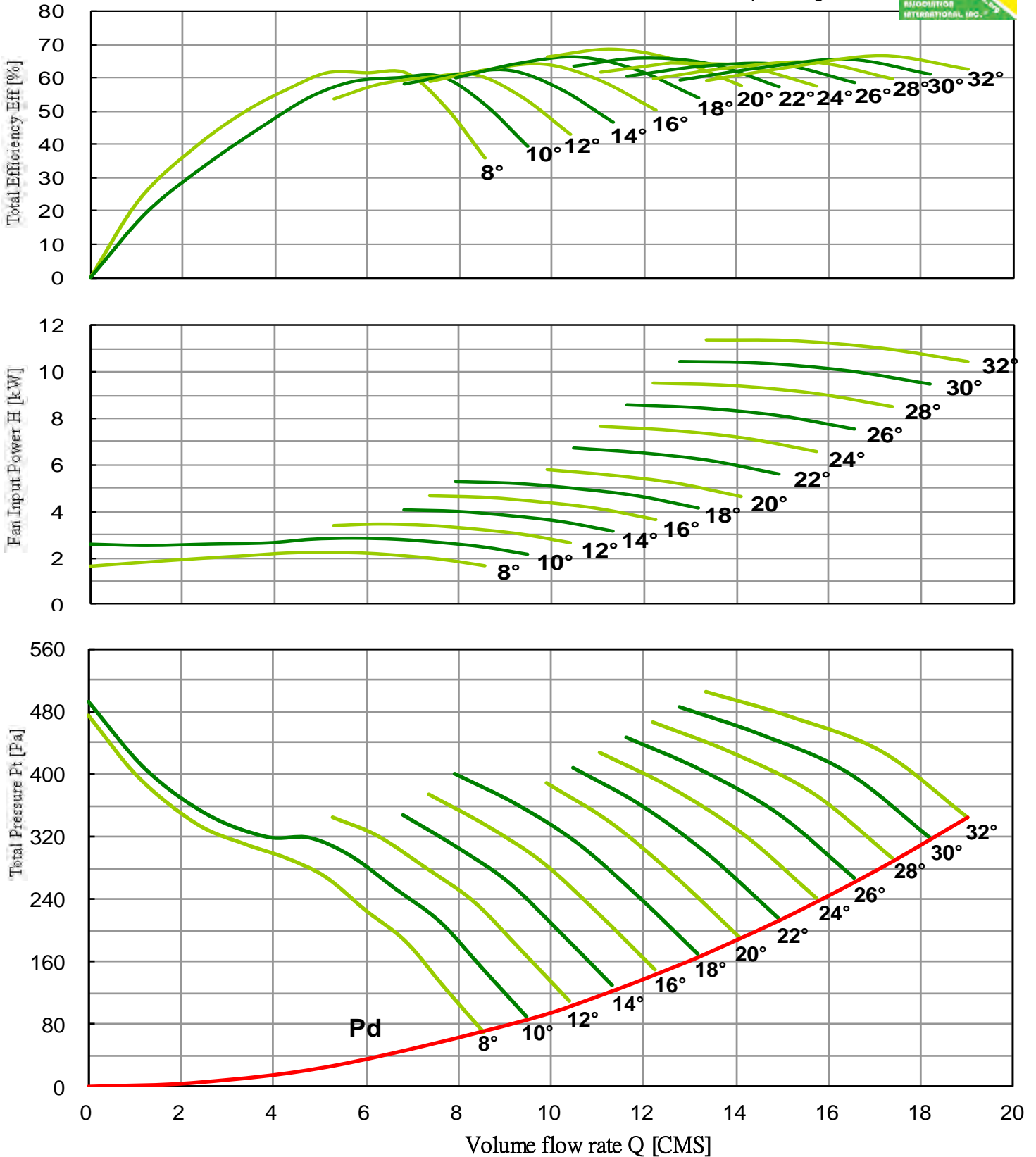

Performance certified is for installation type B: free inlet, ducted outlet. Performance ratings do not include the effects of appurtenances (accessories).

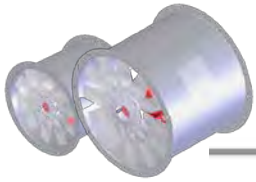

# Axial Fan Driven Directly



LASD-1000-300-12 **50Hz** Performance curves



**FEG 71**

Fan Speed ; N = 720 [RPM]    Outlet Area ; A = 0.7933 [m<sup>2</sup>]

$\rho = 1.2\text{kg/m}^3$

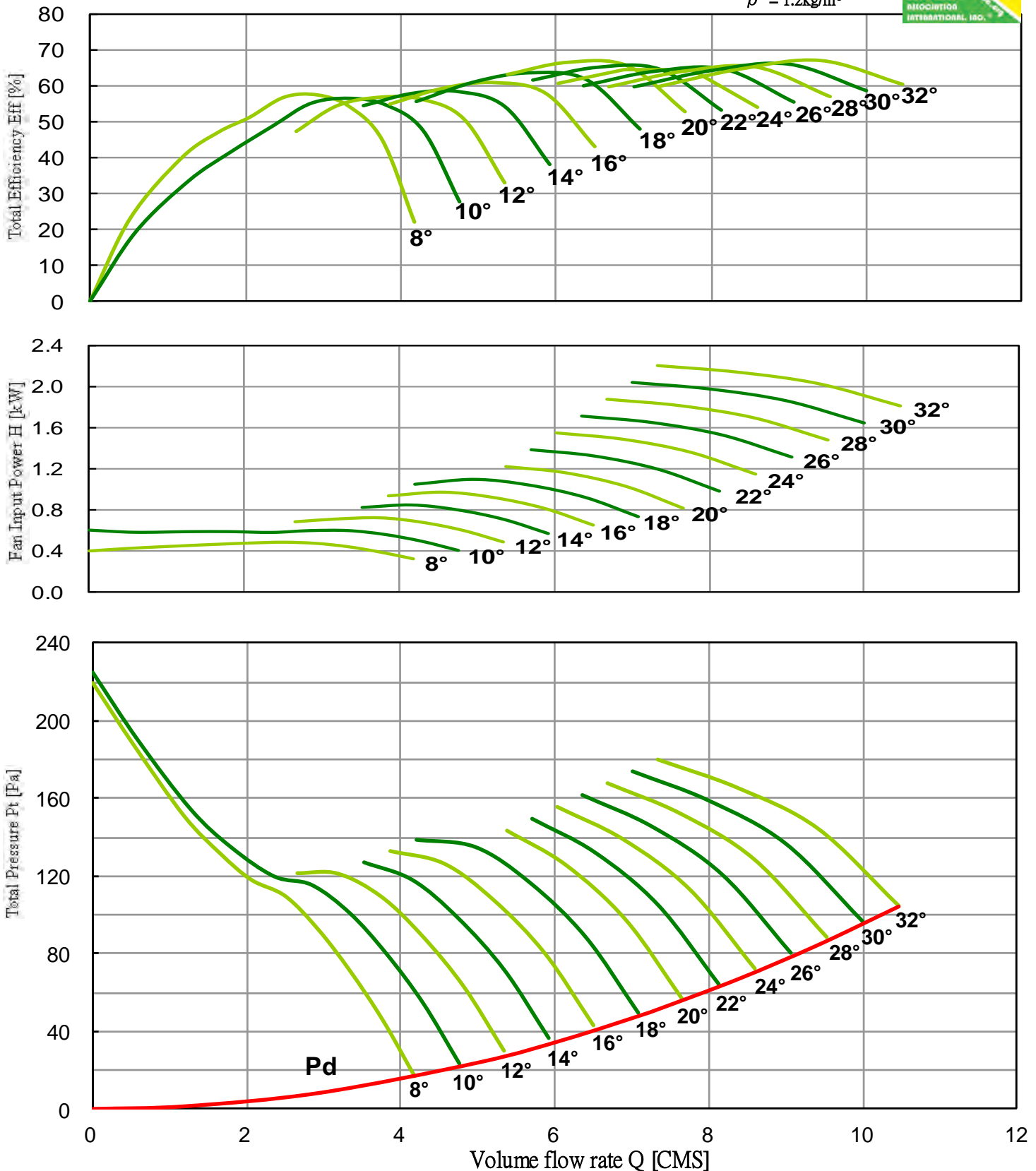

Performance certified is for installation type B: free inlet, ducted outlet. Performance ratings do not include the effects of appurtenances (accessories).

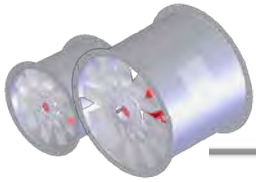

# Axial Fan Driven Directly



LASD-1000-300-12 **50Hz** Performance curves



**FEG 71**

Fan Speed ; N = 960 [RPM]    Outlet Area ; A = 0.7933 [m<sup>2</sup>]

$\rho = 1.2\text{kg/m}^3$

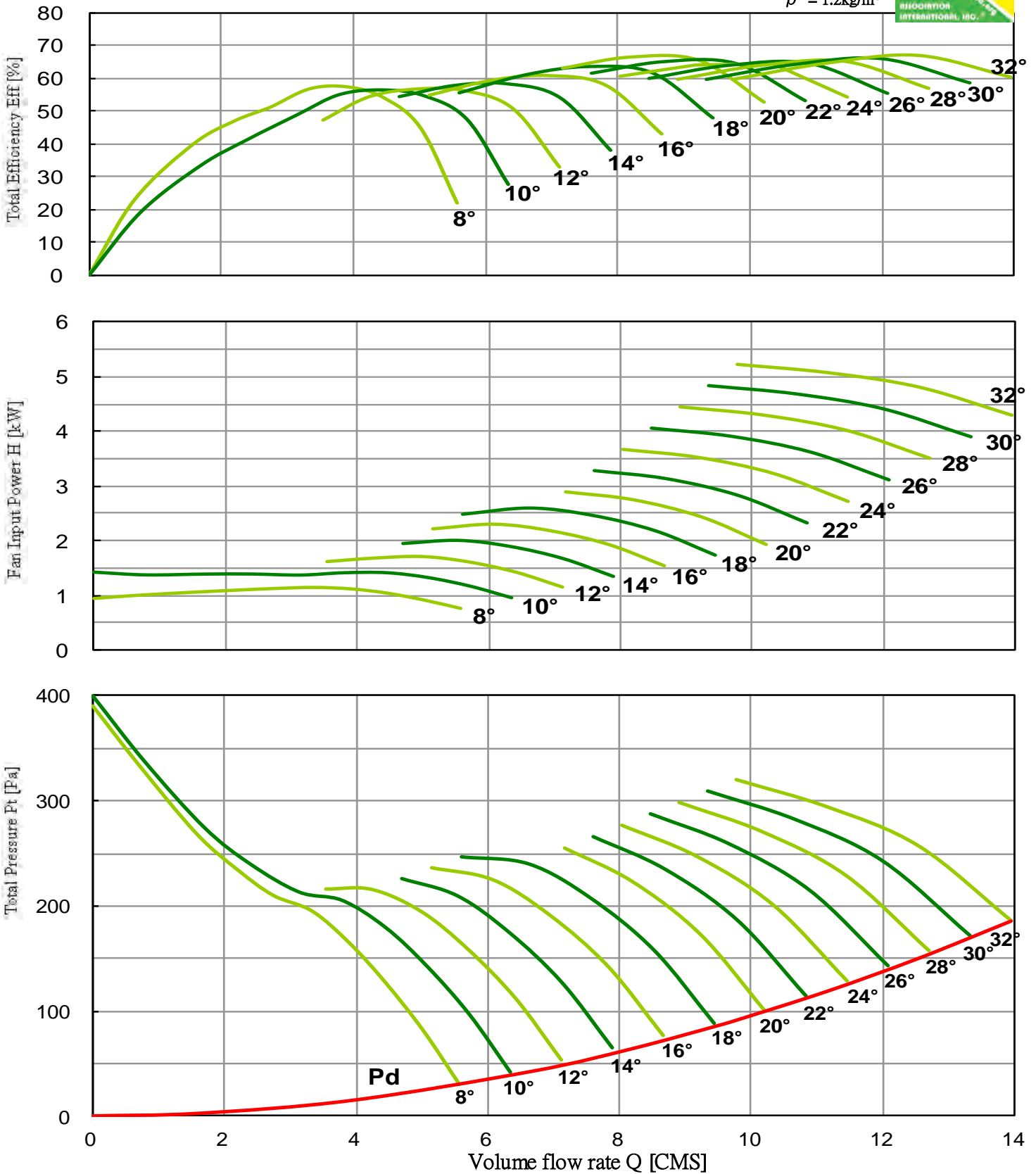

Performance certified is for installation type B: free inlet, ducted outlet. Performance ratings do not include the effects of appurtenances (accessories).

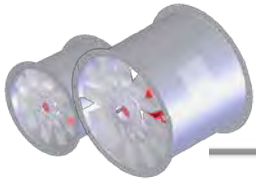

# Axial Fan Driven Directly



LASD-1000-300-12 50Hz Performance curves

**FEG 71**

Fan Speed ; N = 1440 [RPM] Outlet Area ; A = 0.7933 [m<sup>2</sup>]

$\rho = 1.2\text{kg/m}^3$

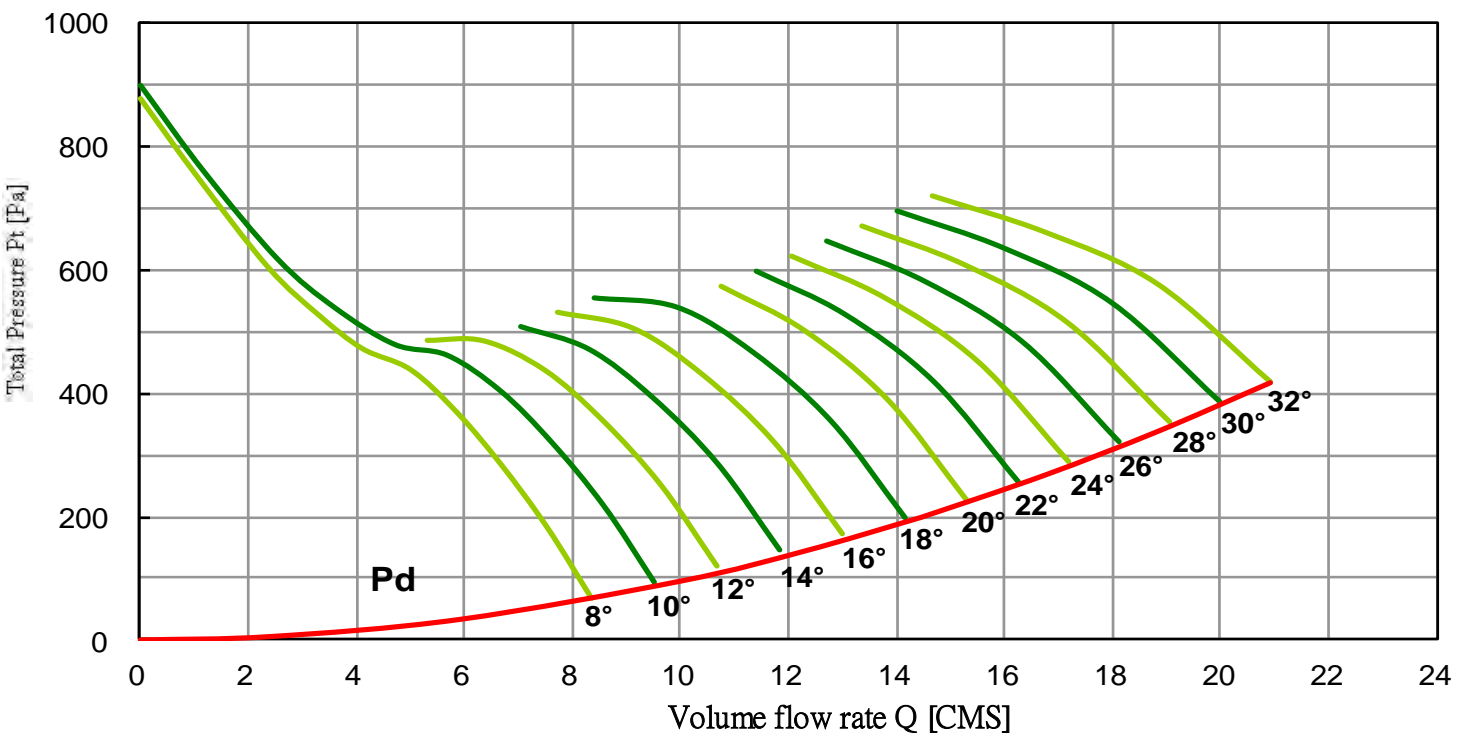
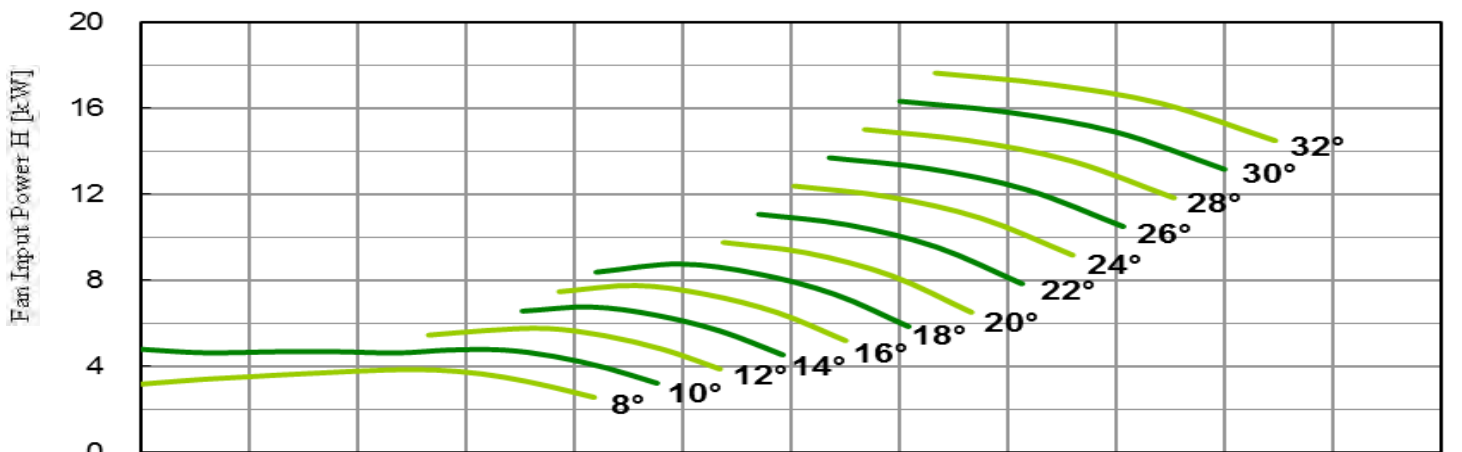
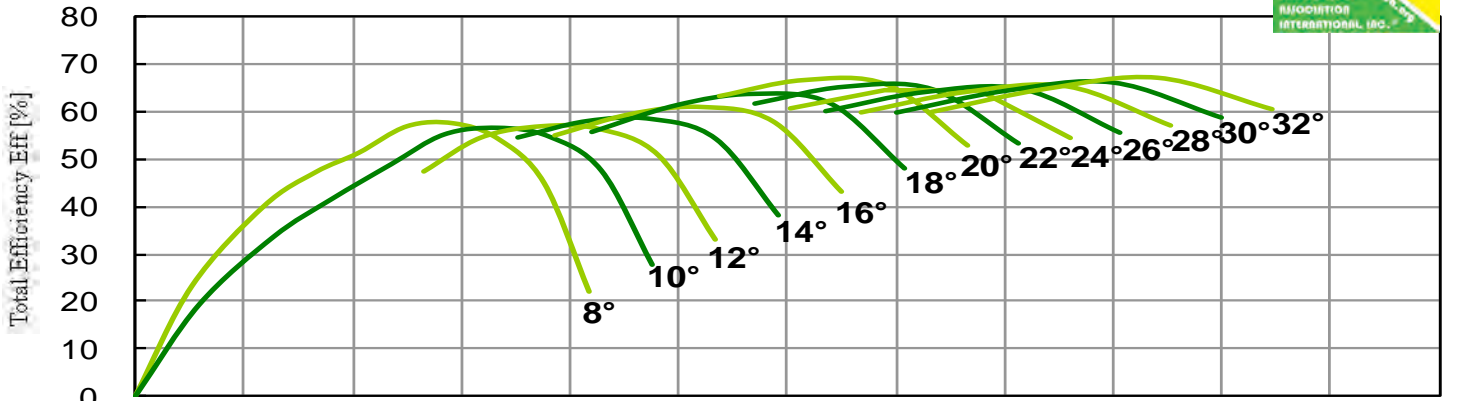

Performance certified is for installation type B: free inlet, ducted outlet. Performance ratings do not include the effects of appurtenances (accessories).

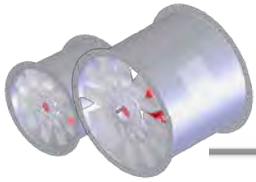

# Axial Fan Driven Directly



LASD-1250-550-7 **50Hz** Performance curves



**FEG 67**

Fan Speed ;  $N = 720$  [RPM]    Outlet Area ;  $A = 1.2272$  [m<sup>2</sup>]

$\rho = 1.2\text{kg/m}^3$

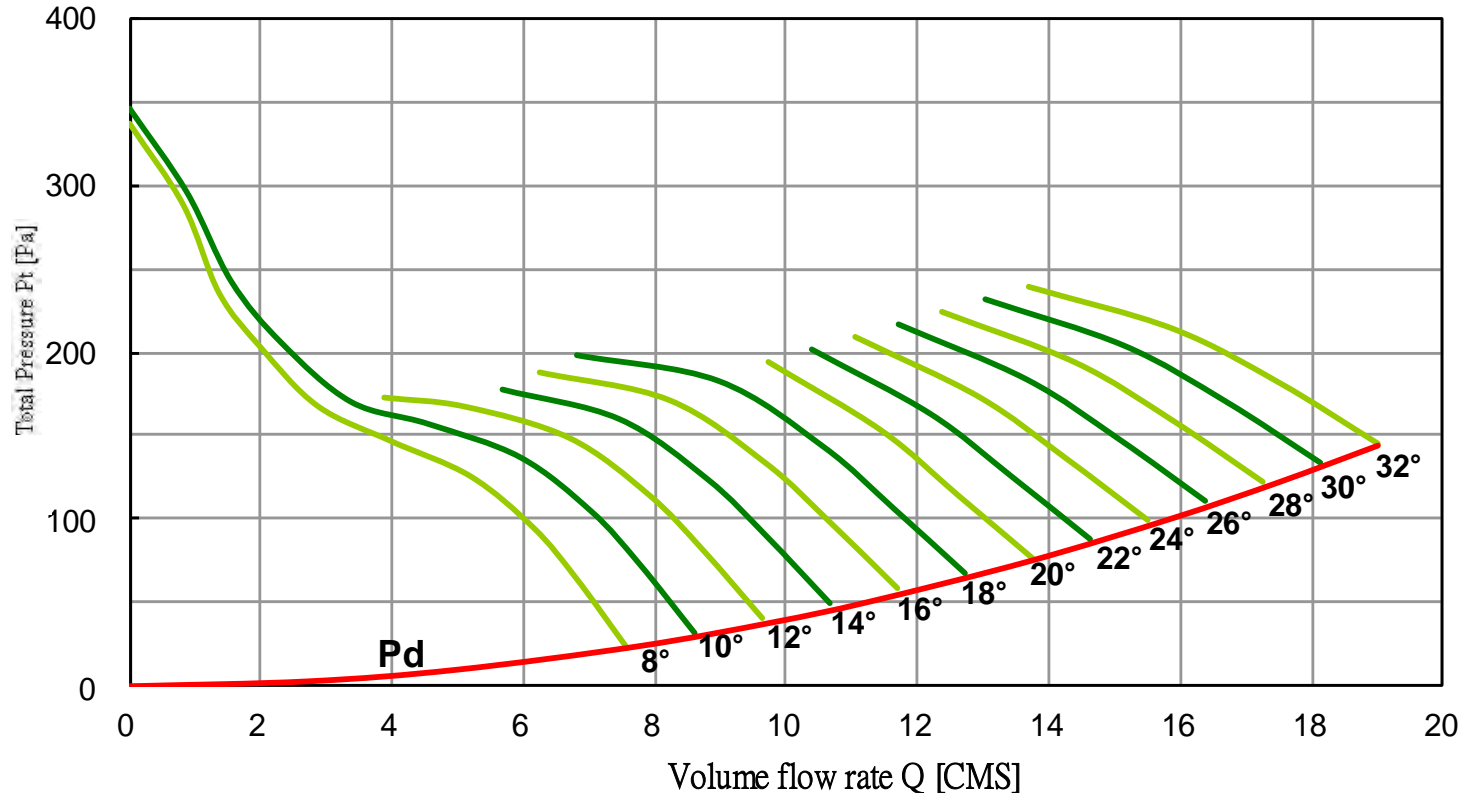
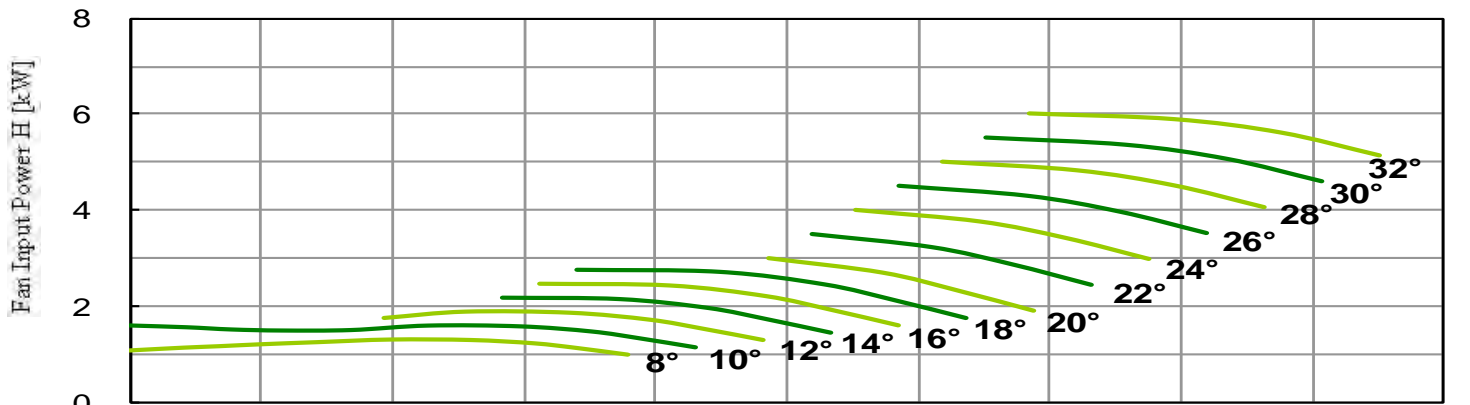
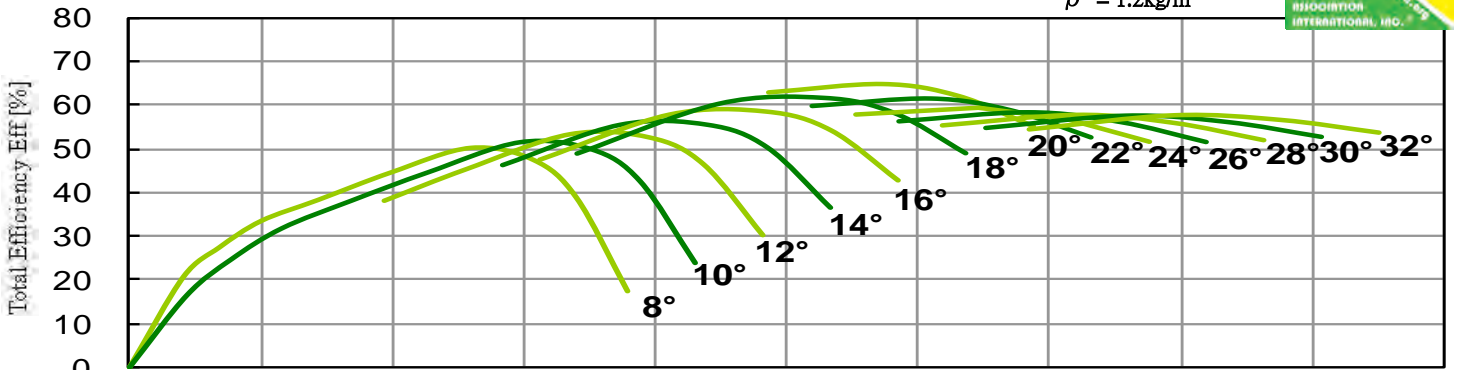

Performance certified is for installation type B: free inlet, ducted outlet. Performance ratings do not include the effects of appurtenances (accessories).

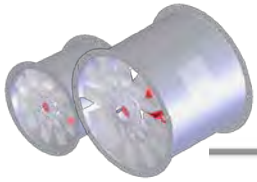

# Axial Fan Driven Directly



LASD-1250-550-7 **50Hz** Performance curves



**FEG 67**

Fan Speed ; N = 960 [RPM] Outlet Area ; A = 1.2272 [m<sup>2</sup>]

$\rho = 1.2\text{kg/m}^3$

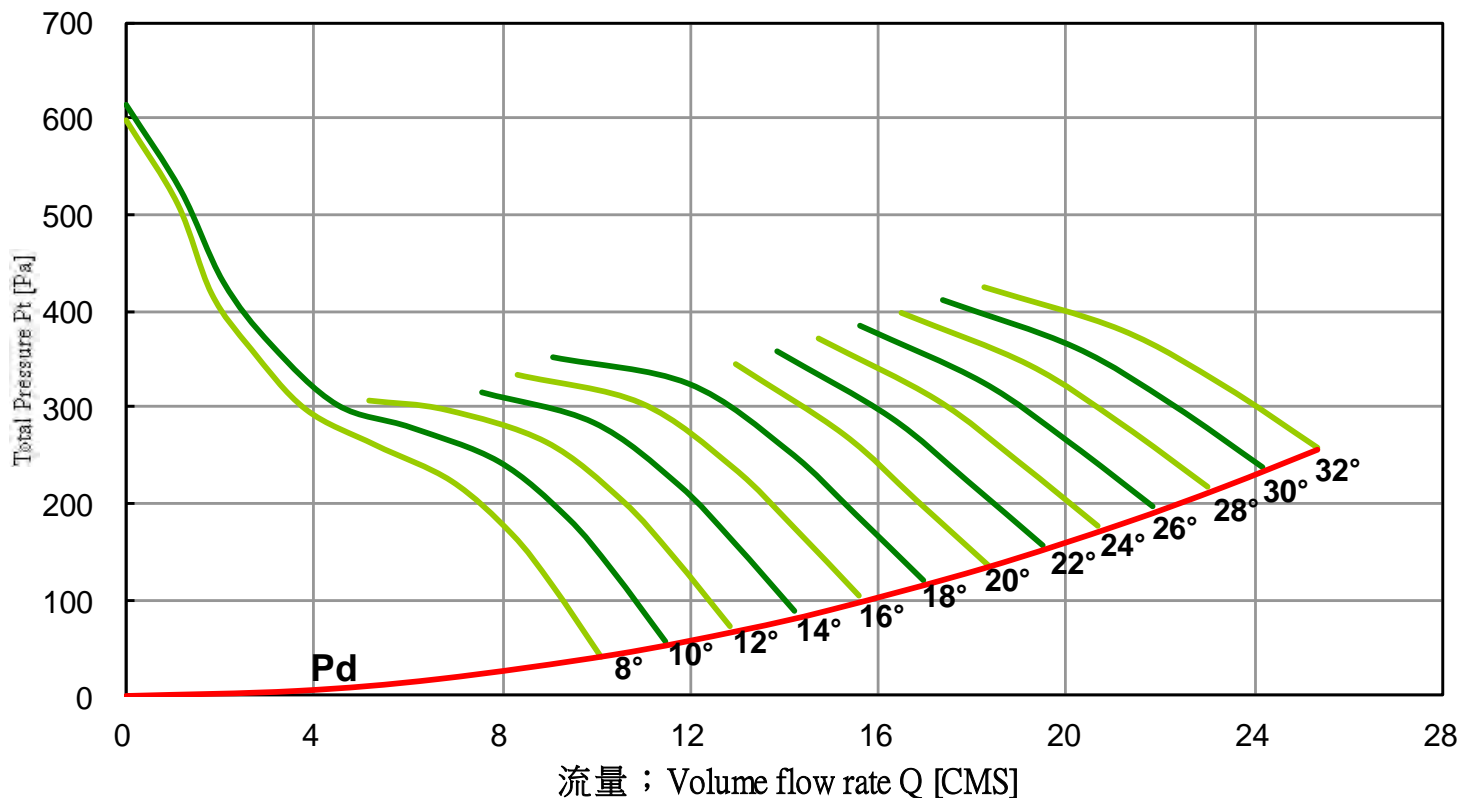
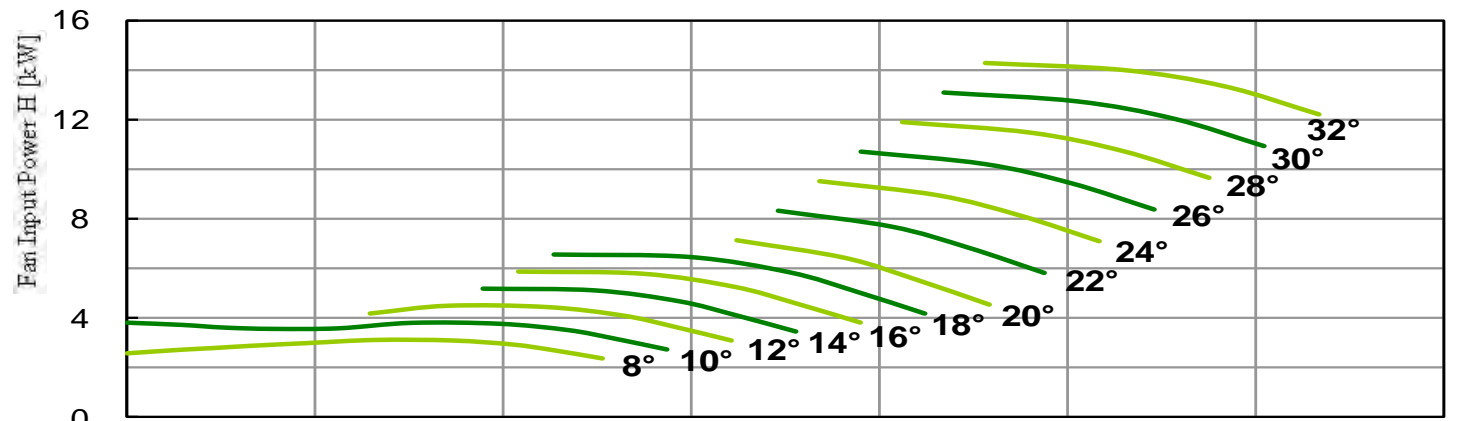
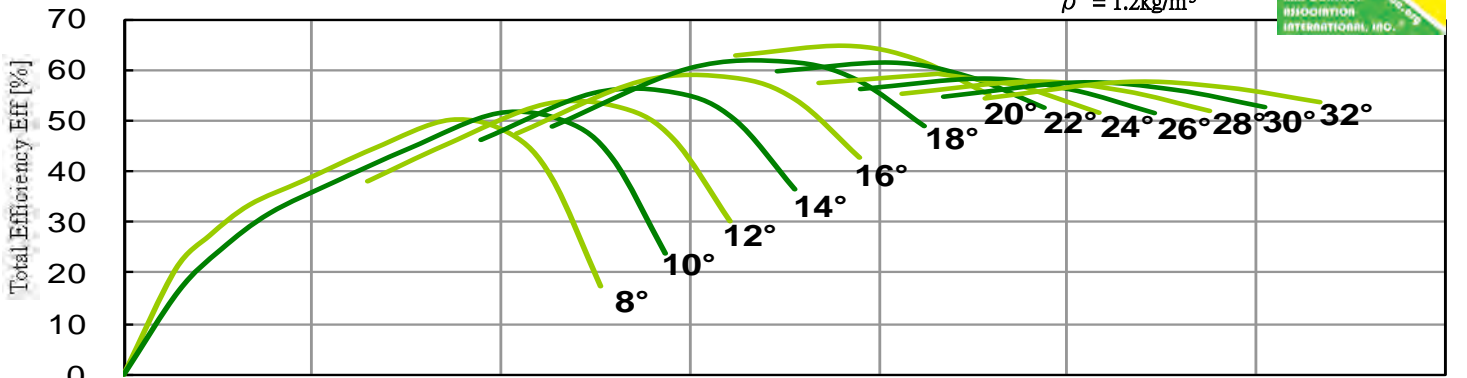

Performance certified is for installation type B: free inlet, ducted outlet. Performance ratings do not include the effects of appurtenances (accessories).



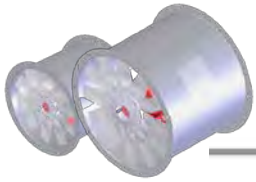

# Axial Fan Driven Directly



LASD-1250-550-7 **50Hz** Performance curves



**FEG 67**

Fan Speed ; N = 1440 [RPM] Outlet Area ; A = 1.2272 [m<sup>2</sup>]

$\rho = 1.2\text{kg/m}^3$

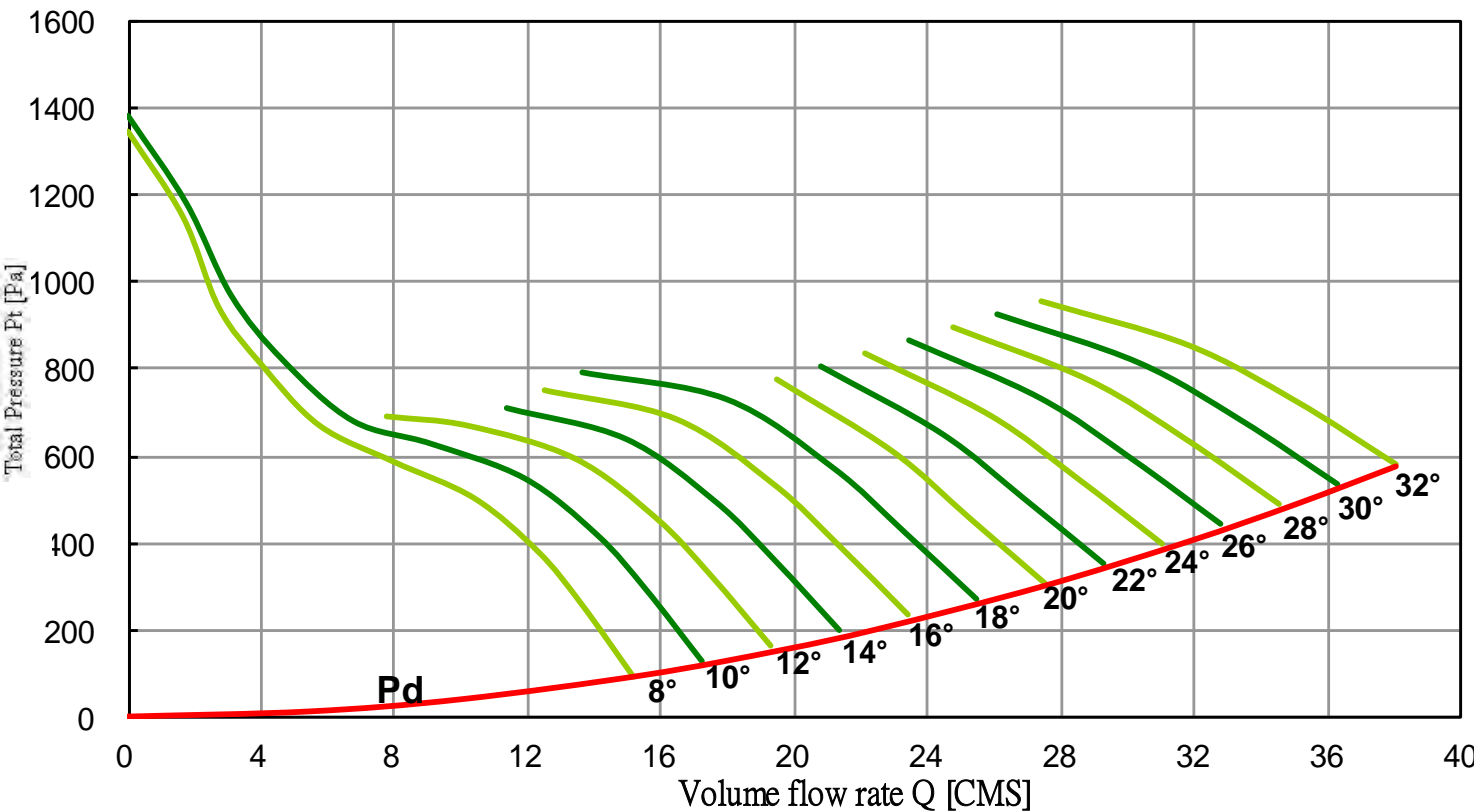
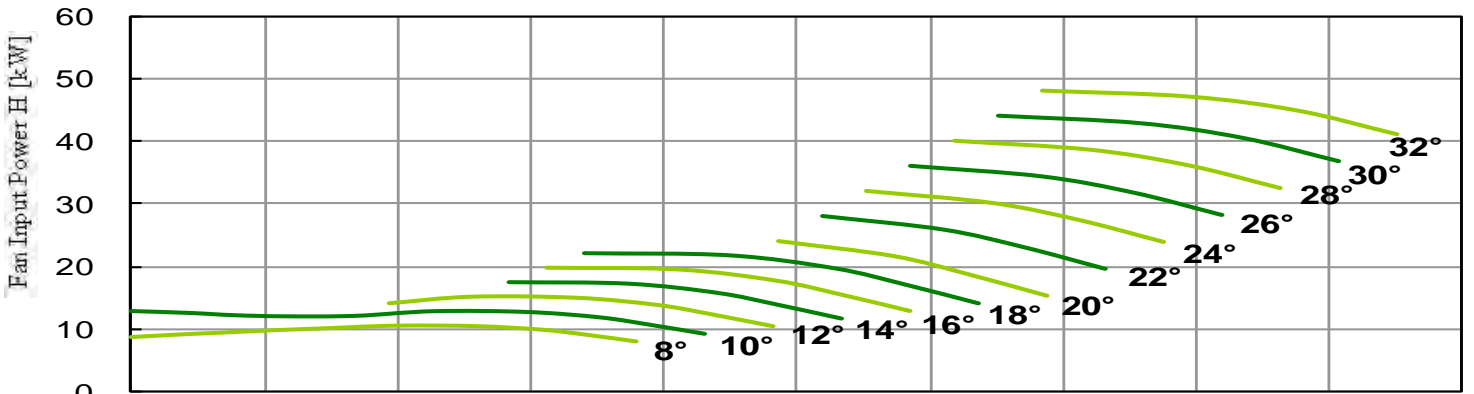
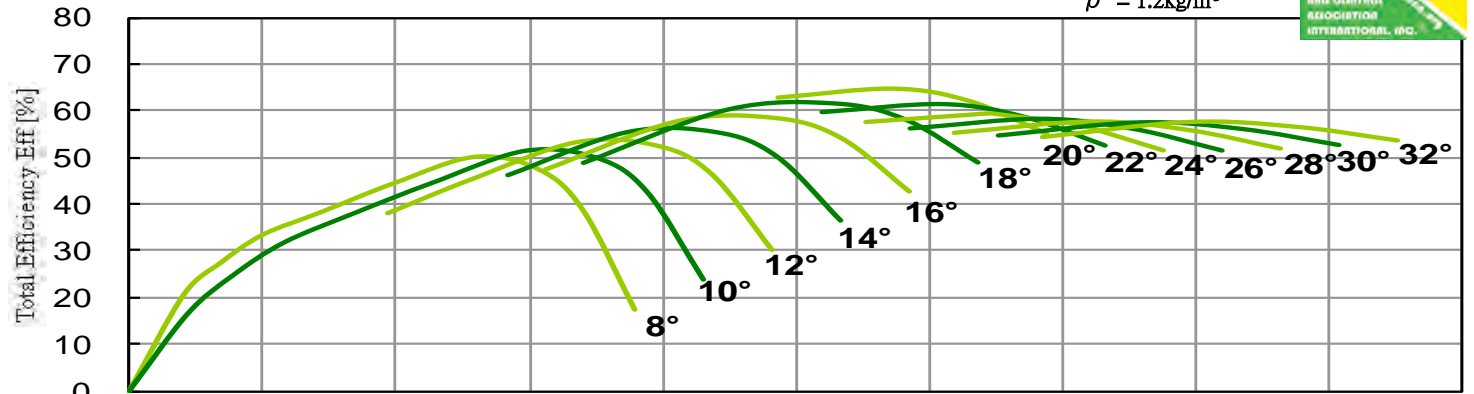

Performance certified is for installation type B: free inlet, ducted outlet. Performance ratings do not include the effects of appurtenances (accessories).



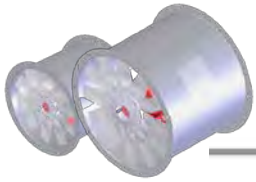

# Axial Fan Driven Directly



LASD-1250-550-14 **50Hz** Performance curves



**FEG 56**

Fan Speed ;  $N = 720$  [RPM]    Outlet Area ;  $A = 1.2272$  [m<sup>2</sup>]

$\rho = 1.2\text{kg/m}^3$

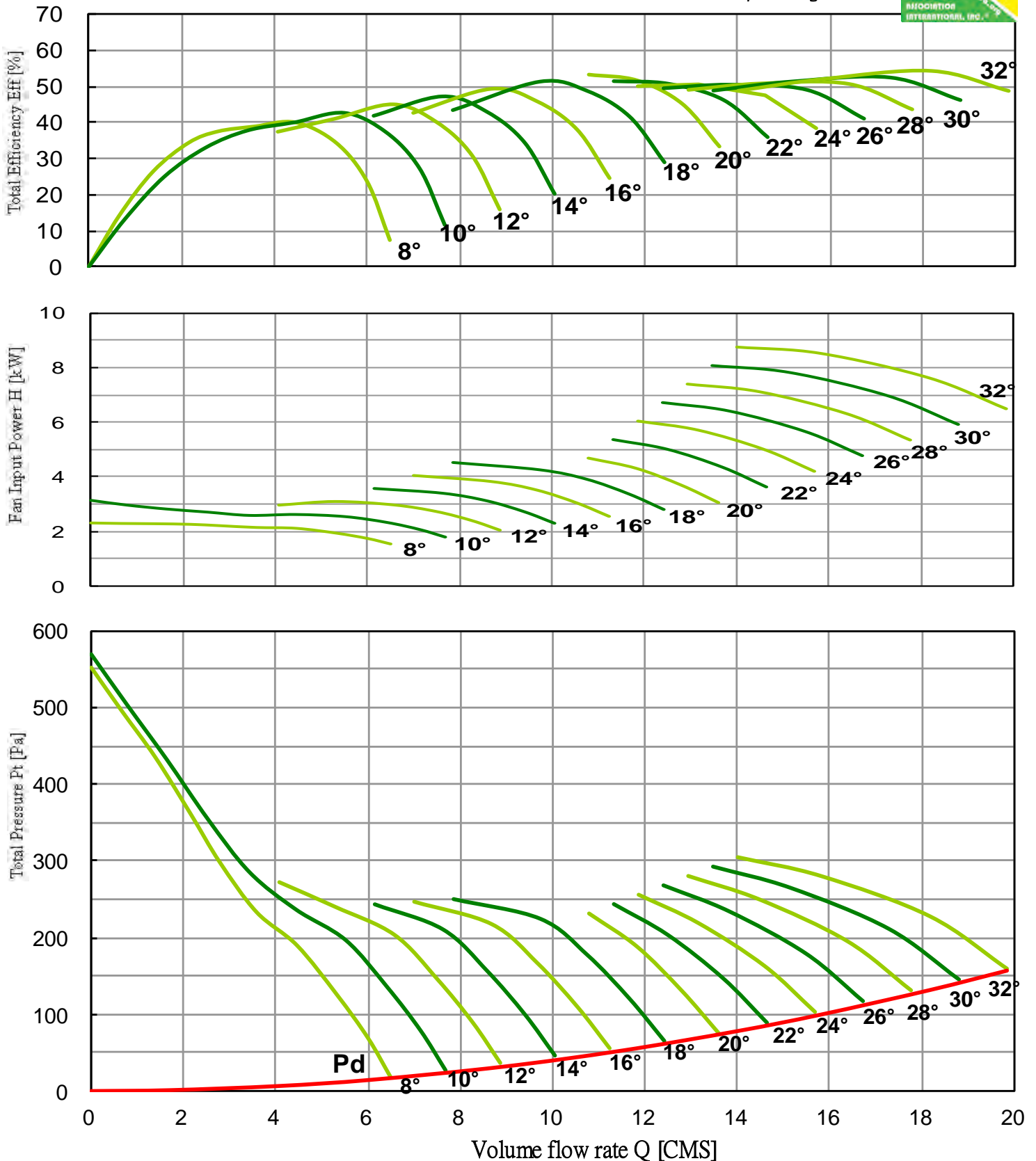

Performance certified is for installation type B: free inlet, ducted outlet. Performance ratings do not include the effects of appurtenances (accessories).

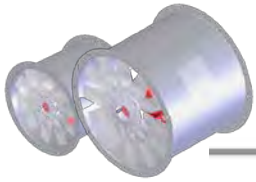

# Axial Fan Driven Directly



LASD-1250-550-14 **50Hz** Performance curves



**FEG 56**

Fan Speed ; N = 960 [RPM]    Outlet Area ; A = 1.2272 [m<sup>2</sup>]

$\rho = 1.2\text{kg/m}^3$

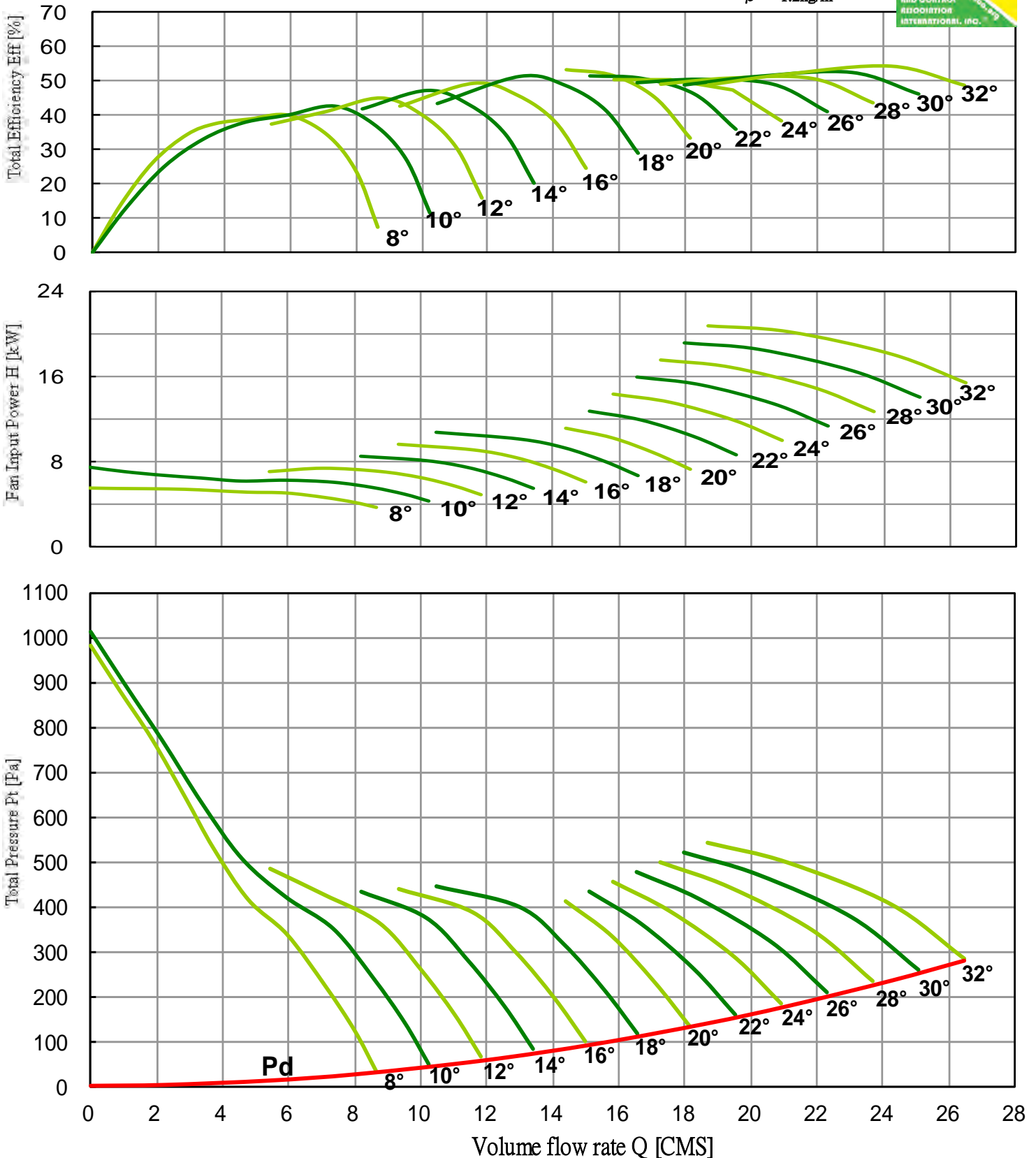

Performance certified is for installation type B: free inlet, ducted outlet. Performance ratings do not include the effects of appurtenances (accessories).

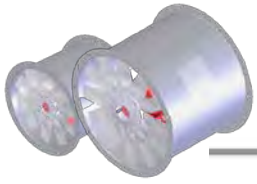

# Axial Fan Driven Directly

## LASD-1250-550-14 50Hz Performance curves

**FEG 56**

Fan Speed ; N = 1440 [RPM]    Outlet Area ; A = 1.2272 [m<sup>2</sup>]

$\rho = 1.2\text{kg/m}^3$

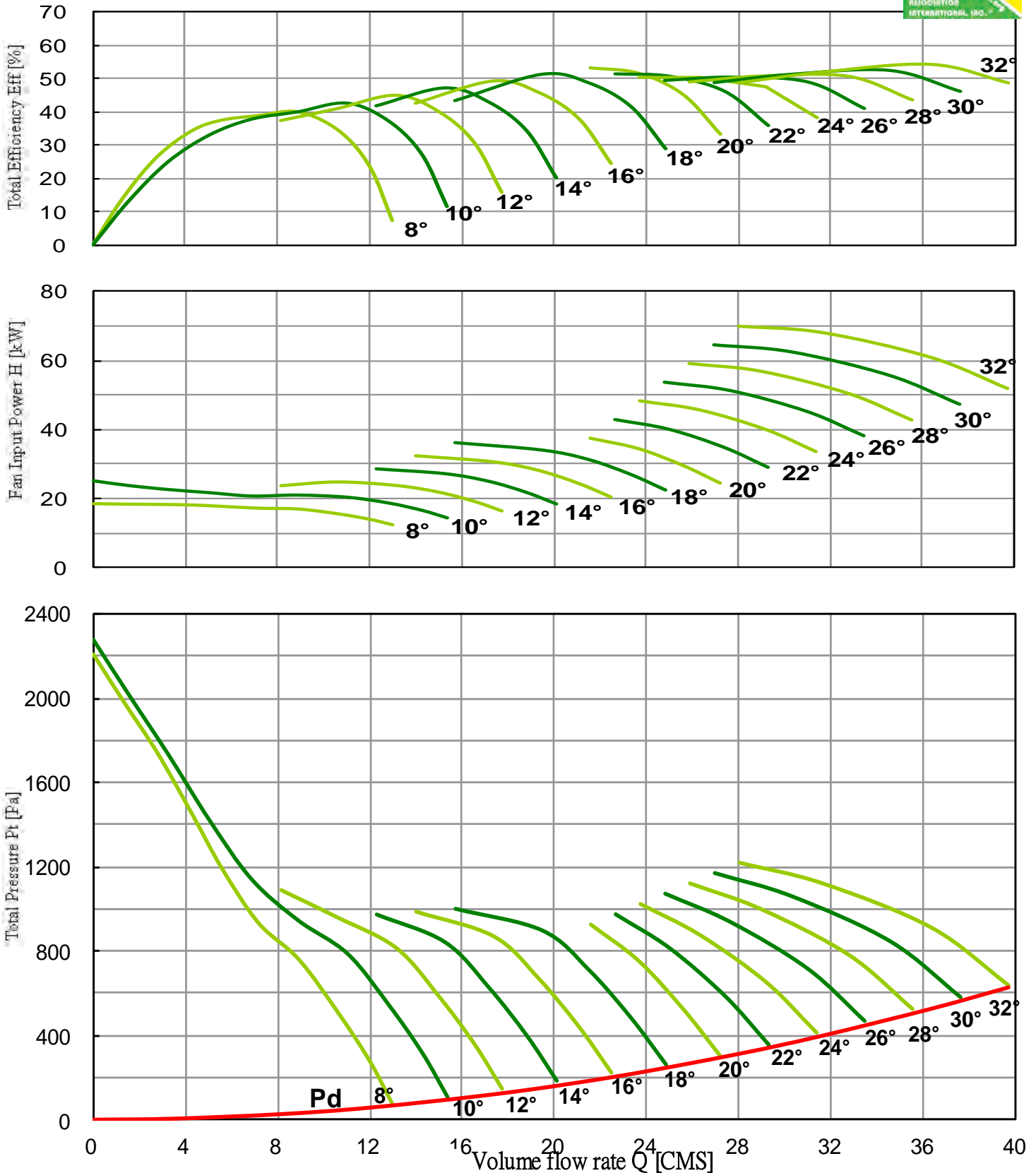

Performance certified is for installation type B: free inlet, ducted outlet. Performance ratings do not include the effects of appurtenances (accessories).

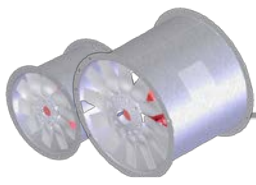

# Axial Smoke-exhaust Fan



LASD-560-200-5

50Hz

Sound Data [dB]

Model No.	N [RPM]	Ps [Pa]	Sound Power re $10^{-12}$ Watts Octave Band [Hz]								L <sub>w</sub> iA [dBA]
			63	125	250	500	1000	2000	4000	8000	
LASD-560-200-5/8°	2850	0	95	97	99	94	94	91	87	83	99
LASD-560-200-5/8°	2850	184	96	97	98	93	95	94	90	84	100
LASD-560-200-5/8°	2850	367	94	96	99	97	99	95	88	81	102
LASD-560-200-5/8°	2850	551	95	98	105	97	94	90	85	81	101
LASD-560-200-5/20°	2850	0	97	100	104	97	96	92	87	83	101
LASD-560-200-5/20°	2850	194	97	100	105	96	95	90	85	81	101
LASD-560-200-5/20°	2850	389	97	99	102	95	94	90	85	83	99
LASD-560-200-5/20°	2850	546	98	100	103	96	96	92	89	86	101
LASD-560-200-5/32°	2850	0	99	102	106	101	99	94	89	86	104
LASD-560-200-5/32°	2850	210	99	102	107	99	98	94	89	86	103
LASD-560-200-5/32°	2850	423	99	102	106	98	97	93	90	88	103
LASD-560-200-5/32°	2850	629	100	102	104	97	97	94	91	89	102
LASD-560-200-5/8°	1440	0	82	85	79	79	76	72	68	60	81
LASD-560-200-5/8°	1440	47	82	84	79	81	79	75	69	60	83
LASD-560-200-5/8°	1440	94	81	85	83	84	80	73	67	60	85
LASD-560-200-5/8°	1440	141	84	91	82	79	75	70	66	61	82
LASD-560-200-5/20°	1440	0	85	90	83	81	77	72	69	62	83
LASD-560-200-5/20°	1440	50	85	91	81	80	76	70	67	60	82
LASD-560-200-5/20°	1440	99	84	88	80	79	75	70	68	62	81
LASD-560-200-5/20°	1440	139	85	89	81	81	78	74	71	66	83
LASD-560-200-5/32°	1440	0	87	92	86	84	80	74	71	66	86
LASD-560-200-5/32°	1440	54	87	93	84	83	79	74	71	67	85
LASD-560-200-5/32°	1440	108	87	92	84	82	79	75	73	70	85
LASD-560-200-5/32°	1440	161	87	90	83	82	79	76	74	71	85
LASD-560-200-5/8°	960	0	76	71	71	69	64	62	55	47	71
LASD-560-200-5/8°	960	21	75	70	71	72	68	63	55	46	73
LASD-560-200-5/8°	960	42	76	73	75	74	67	61	54	47	74
LASD-560-200-5/8°	960	62	82	75	71	68	63	59	54	49	70
LASD-560-200-5/20°	960	0	81	75	74	70	65	62	56	49	72
LASD-560-200-5/20°	960	22	82	74	72	69	63	60	54	47	70
LASD-560-200-5/20°	960	44	79	73	71	68	63	61	56	50	70
LASD-560-200-5/20°	960	62	80	73	73	70	66	64	59	54	72
LASD-560-200-5/32°	960	0	83	78	76	73	67	64	59	54	74
LASD-560-200-5/32°	960	24	84	77	75	72	67	64	60	56	74
LASD-560-200-5/32°	960	48	83	76	75	71	67	65	62	59	74
LASD-560-200-5/32°	960	71	81	75	74	72	68	66	63	60	74

The sound power level ratings shown are in decibels referred to  $10^{-12}$  watts, calculated per AMCA International Standard 301. The A-weighted sound ratings shown have been calculated per AMCA International Standard 301. Values shown are for inlet L<sub>w</sub>i and L<sub>w</sub>iA sound power levels for Installation Type B : free inlet, ducted outlet.

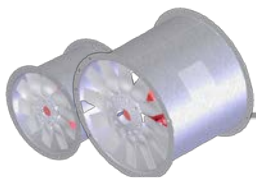

# Axial Smoke-exhaust Fan



LASD-560-200-10

50Hz

Sound Data [dB]

Model No.	N [RPM]	Ps [Pa]	Sound Power re $10^{-12}$ Watts								L <sub>w</sub> iA [dBA]
			Octave Band [Hz]								
			63	125	250	500	1000	2000	4000	8000	
LASD-560-200-10/8°	2850	0	92	94	99	99	96	93	90	86	101
LASD-560-200-10/8°	2850	378	90	92	96	97	98	97	93	87	103
LASD-560-200-10/8°	2850	752	97	97	99	103	97	93	88	84	103
LASD-560-200-10/8°	2850	1130	97	97	99	102	96	93	90	86	103
LASD-560-200-10/20°	2850	0	98	99	101	103	98	94	90	87	104
LASD-560-200-10/20°	2850	197	97	98	101	102	98	94	90	86	103
LASD-560-200-10/20°	2850	396	97	98	100	101	97	93	89	86	102
LASD-560-200-10/20°	2850	630	98	99	101	99	99	96	92	87	103
LASD-560-200-10/32°	2850	0	99	100	102	104	101	97	92	87	106
LASD-560-200-10/32°	2850	257	99	100	103	104	100	95	91	86	105
LASD-560-200-10/32°	2850	517	99	101	104	103	98	94	91	86	104
LASD-560-200-10/32°	2850	761	98	101	105	101	99	96	93	88	104
LASD-560-200-10/8°	1440	0	79	84	85	81	78	75	71	63	84
LASD-560-200-10/8°	1440	97	77	81	82	84	82	78	72	64	86
LASD-560-200-10/8°	1440	192	83	84	89	82	78	73	69	64	85
LASD-560-200-10/8°	1440	289	83	84	88	81	78	75	71	66	84
LASD-560-200-10/20°	1440	0	84	86	89	83	79	75	72	63	86
LASD-560-200-10/20°	1440	50	84	86	88	83	79	75	71	63	85
LASD-560-200-10/20°	1440	101	83	85	87	82	78	74	71	63	84
LASD-560-200-10/20°	1440	161	85	86	85	84	82	78	73	66	86
LASD-560-200-10/32°	1440	0	85	87	90	86	82	77	73	66	88
LASD-560-200-10/32°	1440	66	86	88	90	85	80	76	72	65	87
LASD-560-200-10/32°	1440	132	86	89	89	83	79	76	72	65	86
LASD-560-200-10/32°	1440	194	86	90	87	84	81	78	73	68	87
LASD-560-200-10/8°	960	0	74	76	73	71	67	65	58	50	73
LASD-560-200-10/8°	960	43	71	73	75	75	71	66	59	51	76
LASD-560-200-10/8°	960	85	74	80	75	71	66	62	57	52	73
LASD-560-200-10/8°	960	128	74	79	74	70	67	64	59	54	73
LASD-560-200-10/20°	960	0	76	80	76	72	67	66	58	49	75
LASD-560-200-10/20°	960	22	76	79	75	72	67	65	58	50	74
LASD-560-200-10/20°	960	45	76	78	74	71	66	65	58	50	73
LASD-560-200-10/20°	960	71	78	76	76	74	70	66	60	53	76
LASD-560-200-10/32°	960	0	77	81	79	75	70	66	60	53	77
LASD-560-200-10/32°	960	29	78	81	78	73	68	65	59	52	76
LASD-560-200-10/32°	960	59	80	80	76	72	68	65	59	52	75
LASD-560-200-10/32°	960	86	82	78	76	73	71	66	61	56	76

The sound power level ratings shown are in decibels referred to  $10^{-12}$  watts, calculated per AMCA International Standard 301. The A-weighted sound ratings shown have been calculated per AMCA International Standard 301. Values shown are for inlet L<sub>w</sub>i and L<sub>w</sub>iA sound power levels for Installation Type B : free inlet, ducted outlet.



# Axial Smoke-exhaust Fan



LASD-630-200-5

50Hz

Sound Data [dB]

Model No.	N [RPM]	Ps [Pa]	Sound Power re $10^{-12}$ Watts								L <sub>w</sub> iA [dBA]
			Octave Band [Hz]								
			63	125	250	500	1000	2000	4000	8000	
LASD-630-200-5/8°	2850	0	93	93	100	100	96	93	89	86	102
LASD-630-200-5/8°	2850	274	94	94	97	99	94	94	92	87	101
LASD-630-200-5/8°	2850	464	96	96	97	100	101	99	92	85	105
LASD-630-200-5/8°	2850	559	98	98	98	102	101	95	90	85	105
LASD-630-200-5/20°	2850	0	100	100	107	104	98	95	90	87	105
LASD-630-200-5/20°	2850	431	101	101	105	103	98	94	89	86	104
LASD-630-200-5/20°	2850	601	102	102	103	101	98	93	89	86	103
LASD-630-200-5/20°	2850	779	106	106	102	104	104	100	94	89	108
LASD-630-200-5/32°	2850	0	103	103	108	107	103	99	94	90	108
LASD-630-200-5/32°	2850	282	103	103	109	105	102	98	93	90	107
LASD-630-200-5/32°	2850	522	103	103	106	104	101	98	92	89	106
LASD-630-200-5/32°	2850	841	103	103	104	102	100	96	92	89	105
LASD-630-200-5/8°	1440	0	79	86	86	81	79	74	72	67	84
LASD-630-200-5/8°	1440	70	80	83	85	79	80	77	72	67	84
LASD-630-200-5/8°	1440	118	82	83	85	87	84	77	70	67	88
LASD-630-200-5/8°	1440	143	84	84	87	87	80	75	70	67	87
LASD-630-200-5/20°	1440	0	86	93	89	83	80	75	73	68	86
LASD-630-200-5/20°	1440	110	87	91	88	83	79	74	71	68	85
LASD-630-200-5/20°	1440	153	88	89	86	83	78	74	72	69	85
LASD-630-200-5/20°	1440	199	92	88	90	90	85	79	74	71	90
LASD-630-200-5/32°	1440	0	89	94	93	88	84	79	75	70	90
LASD-630-200-5/32°	1440	72	89	95	90	87	83	78	75	71	89
LASD-630-200-5/32°	1440	133	89	92	89	86	83	77	75	72	88
LASD-630-200-5/32°	1440	215	89	90	88	85	81	77	75	73	87
LASD-630-200-5/8°	960	0	77	77	74	71	67	64	60	55	73
LASD-630-200-5/8°	960	31	74	75	73	70	69	65	60	55	74
LASD-630-200-5/8°	960	53	74	75	77	76	71	64	59	56	77
LASD-630-200-5/8°	960	63	75	77	78	74	68	63	59	56	75
LASD-630-200-5/20°	960	0	84	82	77	72	68	65	61	56	75
LASD-630-200-5/20°	960	49	82	80	76	72	67	63	60	57	74
LASD-630-200-5/20°	960	68	80	78	75	71	67	64	61	58	74
LASD-630-200-5/20°	960	88	79	80	81	78	73	67	63	60	79
LASD-630-200-5/32°	960	0	85	84	81	77	72	68	63	58	79
LASD-630-200-5/32°	960	32	86	83	79	76	71	67	64	60	78
LASD-630-200-5/32°	960	59	83	81	78	75	71	67	64	61	77
LASD-630-200-5/32°	960	95	81	80	77	74	70	67	65	63	76

The sound power level ratings shown are in decibels referred to  $10^{-12}$  watts, calculated per AMCA International Standard 301. The A-weighted sound ratings shown have been calculated per AMCA International Standard 301. Values shown are for inlet L<sub>w</sub>i and L<sub>w</sub>iA sound power levels for Installation Type B : free inlet, ducted outlet.



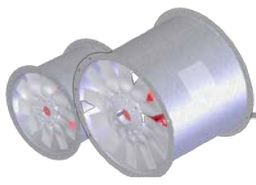

# Axial Smoke-exhaust Fan



LASD-630-200-10

50Hz

Sound Data [dB]

Model No.	N [RPM]	Ps [Pa]	Sound Power re $10^{-12}$ Watts								L <sub>w</sub> iA [dBA]
			Octave Band [Hz]								
			63	125	250	500	1000	2000	4000	8000	
LASD-630-200-10/8°	2850	0	89	89	92	103	98	95	93	90	104
LASD-630-200-10/8°	2850	414	88	88	93	101	99	100	96	90	105
LASD-630-200-10/8°	2850	829	92	92	101	108	103	98	93	87	108
LASD-630-200-10/8°	2850	1243	93	93	100	109	102	98	94	90	109
LASD-630-200-10/20°	2850	0	95	95	98	108	101	97	94	91	108
LASD-630-200-10/20°	2850	406	95	95	97	109	99	96	93	90	108
LASD-630-200-10/20°	2850	696	95	95	97	108	98	95	93	89	107
LASD-630-200-10/20°	2850	978	94	94	99	107	104	101	96	91	109
LASD-630-200-10/32°	2850	0	101	101	102	107	103	100	97	94	108
LASD-630-200-10/32°	2850	456	100	100	100	106	102	99	96	93	107
LASD-630-200-10/32°	2850	758	99	99	99	108	102	99	96	93	108
LASD-630-200-10/32°	2850	1036	100	100	101	105	101	98	96	94	107
LASD-630-200-10/8°	1440	0	75	77	89	83	81	78	75	68	86
LASD-630-200-10/8°	1440	106	74	78	87	85	86	81	75	69	89
LASD-630-200-10/8°	1440	212	78	86	94	88	83	78	72	68	90
LASD-630-200-10/8°	1440	317	79	85	95	87	83	79	75	70	90
LASD-630-200-10/20°	1440	0	81	83	94	86	82	79	76	70	89
LASD-630-200-10/20°	1440	104	81	83	95	84	82	78	75	70	89
LASD-630-200-10/20°	1440	178	81	83	94	83	81	78	74	69	88
LASD-630-200-10/20°	1440	250	80	84	93	89	86	81	76	71	91
LASD-630-200-10/32°	1440	0	87	88	93	88	86	82	79	72	91
LASD-630-200-10/32°	1440	116	86	86	92	87	84	81	78	72	90
LASD-630-200-10/32°	1440	194	85	85	94	87	84	81	78	73	90
LASD-630-200-10/32°	1440	264	86	87	91	86	84	82	79	75	90
LASD-630-200-10/8°	960	0	67	80	77	73	70	67	62	55	76
LASD-630-200-10/8°	960	47	68	78	77	76	74	69	63	57	78
LASD-630-200-10/8°	960	94	74	85	82	76	71	66	61	57	78
LASD-630-200-10/8°	960	141	74	86	81	76	72	68	63	58	79
LASD-630-200-10/20°	960	0	73	85	80	75	71	68	64	58	78
LASD-630-200-10/20°	960	46	73	86	80	74	71	67	63	58	78
LASD-630-200-10/20°	960	79	73	85	79	73	70	67	62	57	77
LASD-630-200-10/20°	960	111	74	84	82	78	74	69	64	59	80
LASD-630-200-10/32°	960	0	78	84	81	78	75	71	66	59	80
LASD-630-200-10/32°	960	52	77	83	80	76	73	70	66	60	79
LASD-630-200-10/32°	960	86	76	85	81	76	73	70	66	61	79
LASD-630-200-10/32°	960	118	77	82	79	76	74	71	68	64	79

The sound power level ratings shown are in decibels referred to  $10^{-12}$  watts, calculated per AMCA International Standard 301. The A-weighted sound ratings shown have been calculated per AMCA International Standard 301. Values shown are for inlet L<sub>w</sub>i and L<sub>w</sub>iA sound power levels for Installation Type B : free inlet, ducted outlet.



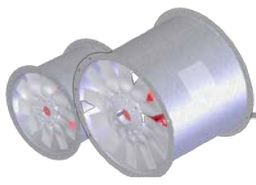

# Axial Smoke-exhaust Fan



LASD-630-300-6

50Hz

Sound Data [dB]

Model No.	N [RPM]	Ps [Pa]	Sound Power re $10^{-12}$ Watts Octave Band [Hz]								L <sub>w</sub> A [dBA]
			63	125	250	500	1000	2000	4000	8000	
LASD-630-300-6/8°	2850	0	89	89	103	99	96	95	91	88	102
LASD-630-300-6/8°	2850	170	89	89	103	100	97	96	91	88	103
LASD-630-300-6/8°	2850	427	92	92	103	100	98	99	95	88	105
LASD-630-300-6/8°	2850	642	94	94	103	105	101	96	90	85	106
LASD-630-300-6/20°	2850	0	94	94	113	102	99	96	91	89	107
LASD-630-300-6/20°	2850	547	95	95	110	100	97	94	89	86	105
LASD-630-300-6/20°	2850	821	101	101	108	102	99	95	91	87	105
LASD-630-300-6/20°	2850	858	101	101	106	104	103	99	93	88	107
LASD-630-300-6/32°	2850	0	101	101	112	106	103	99	94	90	109
LASD-630-300-6/32°	2850	369	101	101	113	106	103	99	93	90	109
LASD-630-300-6/32°	2850	609	102	102	112	105	102	98	93	90	108
LASD-630-300-6/32°	2850	932	103	103	112	105	99	96	93	90	107
LASD-630-300-6/8°	1440	0	75	89	84	82	81	76	74	68	85
LASD-630-300-6/8°	1440	43	75	89	85	83	82	76	74	68	86
LASD-630-300-6/8°	1440	109	78	89	85	84	85	80	73	67	88
LASD-630-300-6/8°	1440	164	80	89	91	86	81	75	70	67	87
LASD-630-300-6/20°	1440	0	80	99	87	85	81	76	75	70	88
LASD-630-300-6/20°	1440	140	81	96	85	82	79	74	71	69	85
LASD-630-300-6/20°	1440	209	87	94	87	84	80	76	72	70	86
LASD-630-300-6/20°	1440	219	87	92	89	89	84	78	73	71	89
LASD-630-300-6/32°	1440	0	87	98	91	88	84	79	75	71	90
LASD-630-300-6/32°	1440	94	87	99	91	88	84	78	75	71	90
LASD-630-300-6/32°	1440	156	88	98	90	87	83	78	75	72	89
LASD-630-300-6/32°	1440	238	89	98	90	84	81	78	75	73	88
LASD-630-300-6/8°	960	0	74	80	74	72	69	66	62	56	75
LASD-630-300-6/8°	960	19	74	80	75	73	70	66	62	56	75
LASD-630-300-6/8°	960	48	75	80	75	75	73	67	61	55	77
LASD-630-300-6/8°	960	73	76	81	79	74	69	63	59	56	76
LASD-630-300-6/20°	960	0	81	90	77	74	69	66	63	58	78
LASD-630-300-6/20°	960	62	80	87	74	71	67	63	61	59	75
LASD-630-300-6/20°	960	93	82	85	76	73	69	65	62	60	76
LASD-630-300-6/20°	960	97	81	83	80	77	72	66	63	61	78
LASD-630-300-6/32°	960	0	84	89	80	77	72	68	64	60	79
LASD-630-300-6/32°	960	42	84	90	80	77	72	67	64	60	80
LASD-630-300-6/32°	960	69	84	89	79	76	71	67	64	61	79
LASD-630-300-6/32°	960	106	85	89	78	73	70	67	65	63	78

The sound power level ratings shown are in decibels referred to  $10^{-12}$  watts, calculated per AMCA International Standard 301. The A-weighted sound ratings shown have been calculated per AMCA International Standard 301. Values shown are for inlet L<sub>w</sub>i and L<sub>w</sub>iA sound power levels for Installation Type B : free inlet, ducted outlet.

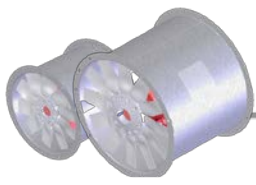

# Axial Smoke-exhaust Fan



LASD-630-300-12

50Hz

Sound Data [dB]

Model No.	N [RPM]	Ps [Pa]	Sound Power re $10^{-12}$ Watts								L <sub>w</sub> iA [dBA]
			Octave Band [Hz]								
			63	125	250	500	1000	2000	4000	8000	
LASD-630-300-12/8°	2850	0	90	90	96	103	100	99	95	92	106
LASD-630-300-12/8°	2850	414	92	92	97	103	101	100	96	90	106
LASD-630-300-12/8°	2850	829	96	96	99	109	104	99	92	86	109
LASD-630-300-12/8°	2850	1243	96	96	101	110	102	98	91	86	109
LASD-630-300-12/20°	2850	0	93	93	98	106	100	98	95	92	107
LASD-630-300-12/20°	2850	431	95	95	98	106	99	96	94	91	106
LASD-630-300-12/20°	2850	725	96	96	97	106	99	96	94	91	106
LASD-630-300-12/20°	2850	883	97	97	100	105	106	101	98	93	109
LASD-630-300-12/32°	2850	0	99	99	102	109	103	100	97	93	109
LASD-630-300-12/32°	2850	530	98	98	101	109	102	99	95	91	109
LASD-630-300-12/32°	2850	841	100	100	101	109	101	98	94	90	108
LASD-630-300-12/32°	2850	1111	101	101	99	110	100	97	94	90	109
LASD-630-300-12/8°	1440	0	76	81	89	85	85	80	77	70	89
LASD-630-300-12/8°	1440	106	78	82	89	86	86	81	75	70	89
LASD-630-300-12/8°	1440	212	82	84	95	89	84	77	71	69	91
LASD-630-300-12/8°	1440	317	82	86	96	87	83	76	71	69	90
LASD-630-300-12/20°	1440	0	79	83	92	85	84	80	78	70	89
LASD-630-300-12/20°	1440	110	81	83	92	84	82	79	77	71	88
LASD-630-300-12/20°	1440	185	82	83	92	84	82	79	76	71	88
LASD-630-300-12/20°	1440	225	83	85	91	92	86	83	78	72	92
LASD-630-300-12/32°	1440	0	85	87	95	88	86	82	78	73	91
LASD-630-300-12/32°	1440	135	84	86	95	87	84	80	76	71	90
LASD-630-300-12/32°	1440	215	86	87	95	86	83	79	75	70	90
LASD-630-300-12/32°	1440	284	87	85	96	85	83	79	75	72	90
LASD-630-300-12/8°	960	0	70	77	80	76	73	69	64	57	78
LASD-630-300-12/8°	960	47	72	77	80	77	74	69	63	58	79
LASD-630-300-12/8°	960	94	74	81	86	77	71	65	61	59	80
LASD-630-300-12/8°	960	141	76	83	87	76	70	64	61	59	80
LASD-630-300-12/20°	960	0	73	79	83	75	73	70	64	56	79
LASD-630-300-12/20°	960	49	73	79	83	74	71	69	65	59	78
LASD-630-300-12/20°	960	82	73	79	83	74	71	68	64	59	78
LASD-630-300-12/20°	960	100	75	80	82	80	75	71	66	60	81
LASD-630-300-12/32°	960	0	77	83	86	78	75	71	66	61	81
LASD-630-300-12/32°	960	60	76	82	86	76	73	69	64	59	80
LASD-630-300-12/32°	960	95	77	82	86	75	72	68	63	58	80
LASD-630-300-12/32°	960	126	77	82	87	75	72	68	64	61	81

The sound power level ratings shown are in decibels referred to  $10^{-12}$  watts, calculated per AMCA International Standard 301. The A-weighted sound ratings shown have been calculated per AMCA International Standard 301. Values shown are for inlet L<sub>w</sub>i and L<sub>w</sub>iA sound power levels for Installation Type B : free inlet, ducted outlet.

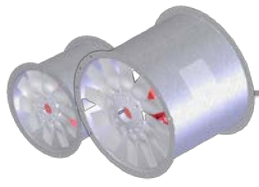

## LASD-710-300-6 50Hz

### Sound Data [dB]

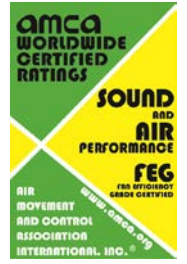

Model No.	N [RPM]	Ps [Pa]	Sound Power re 10 <sup>-12</sup> Watts Octave Band [Hz]								L <sub>wi</sub> A [dBA]
			63	125	250	500	1000	2000	4000	8000	
LASD-710-300-6/8°	2850	0	92	92	105	104	99	97	94	93	106
LASD-710-300-6/8°	2850	332	92	92	104	104	102	102	99	94	108
LASD-710-300-6/8°	2850	572	96	96	103	107	105	103	96	90	110
LASD-710-300-6/8°	2850	700	97	97	109	109	103	99	94	89	109
LASD-710-300-6/20°	2850	0	99	99	110	107	101	98	95	94	108
LASD-710-300-6/20°	2850	327	99	99	109	106	100	97	94	92	107
LASD-710-300-6/20°	2850	584	100	100	108	105	100	96	93	90	106
LASD-710-300-6/20°	2850	908	103	103	106	112	109	105	100	95	113
LASD-710-300-6/32°	2850	0	106	106	111	109	105	102	97	94	110
LASD-710-300-6/32°	2850	394	106	106	111	109	104	101	97	94	110
LASD-710-300-6/32°	2850	675	107	107	109	106	103	100	97	94	108
LASD-710-300-6/32°	2850	1024	107	107	110	106	103	101	99	96	109
LASD-710-300-6/8°	1440	0	78	91	90	84	83	79	79	70	88
LASD-710-300-6/8°	1440	85	78	90	90	87	88	84	79	70	91
LASD-710-300-6/8°	1440	146	82	89	92	91	88	81	75	69	92
LASD-710-300-6/8°	1440	179	83	95	95	88	84	79	74	69	91
LASD-710-300-6/20°	1440	0	85	96	92	86	83	80	80	71	90
LASD-710-300-6/20°	1440	84	85	95	91	85	82	79	78	70	89
LASD-710-300-6/20°	1440	149	86	94	90	85	81	78	76	71	88
LASD-710-300-6/20°	1440	232	89	92	97	94	90	85	80	74	95
LASD-710-300-6/32°	1440	0	92	97	94	90	87	82	79	74	92
LASD-710-300-6/32°	1440	101	92	97	94	89	86	82	79	75	92
LASD-710-300-6/32°	1440	172	93	95	91	88	85	83	79	76	91
LASD-710-300-6/32°	1440	261	93	96	91	88	87	84	81	78	92

The sound power level ratings shown are in decibels referred to 10<sup>-12</sup> watts, calculated per AMCA International Standard 301. The A-weighted sound ratings shown have been calculated per AMCA International Standard 301. Values shown are for inlet L<sub>wi</sub> and L<sub>wi</sub>A sound power levels for Installation Type B : free inlet, ducted outlet.

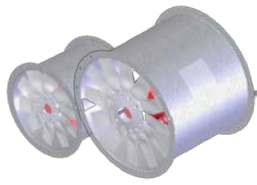

## LASD-710-300-6 50Hz

### Sound Data [dB]

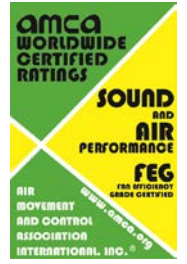

Model No.	N [RPM]	Ps [Pa]	Sound Power re 10 <sup>-12</sup> Watts Octave Band [Hz]								L <sub>wi</sub> A [dBA]
			63	125	250	500	1000	2000	4000	8000	
LASD-710-300-6/8°	960	0	76	82	78	74	72	70	65	56	78
LASD-710-300-6/8°	960	38	75	81	79	78	77	72	65	56	81
LASD-710-300-6/8°	960	65	77	82	83	80	75	69	63	57	81
LASD-710-300-6/8°	960	79	80	86	82	77	72	67	62	57	79
LASD-710-300-6/20°	960	0	82	87	80	75	72	71	66	57	79
LASD-710-300-6/20°	960	37	81	86	79	74	71	69	64	56	78
LASD-710-300-6/20°	960	66	81	85	78	74	70	68	64	59	77
LASD-710-300-6/20°	960	103	81	86	87	83	78	73	68	62	84
LASD-710-300-6/32°	960	0	86	88	83	79	75	71	67	62	82
LASD-710-300-6/32°	960	45	86	88	82	78	75	71	68	64	81
LASD-710-300-6/32°	960	77	85	86	80	77	75	72	68	65	80
LASD-710-300-6/32°	960	116	85	87	80	78	76	73	70	67	82
LASD-710-300-6/8°	720	0	76	75	69	68	64	64	55	46	70
LASD-710-300-6/8°	720	21	75	75	72	73	69	64	55	46	74
LASD-710-300-6/8°	720	36	74	77	76	73	66	60	54	48	73
LASD-710-300-6/8°	720	45	80	80	73	69	64	59	54	49	71
LASD-710-300-6/20°	720	0	81	77	71	68	65	65	56	47	71
LASD-710-300-6/20°	720	21	80	76	70	67	64	63	55	47	70
LASD-710-300-6/20°	720	37	79	75	70	66	63	61	56	51	69
LASD-710-300-6/20°	720	58	77	82	79	75	70	65	59	53	76
LASD-710-300-6/32°	720	0	82	79	75	72	67	64	59	54	74
LASD-710-300-6/32°	720	25	82	79	74	71	67	64	60	56	73
LASD-710-300-6/32°	720	43	80	76	73	70	68	64	61	58	73
LASD-710-300-6/32°	720	65	81	76	73	72	69	66	63	60	74

The sound power level ratings shown are in decibels referred to 10<sup>-12</sup> watts, calculated per AMCA International Standard 301. The A-weighted sound ratings shown have been calculated per AMCA International Standard 301. Values shown are for inlet L<sub>wi</sub> and L<sub>wi</sub>A sound power levels for Installation Type B : free inlet, ducted outlet.

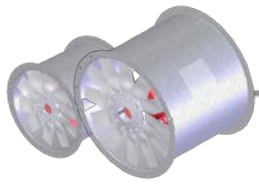

## LASD-710-300-12 50Hz

### Sound Data [dB]



Model No.	N [RPM]	Ps [Pa]	Sound Power re 10 <sup>-12</sup> Watts Octave Band [Hz]								L <sub>wi</sub> A [dBA]
			63	125	250	500	1000	2000	4000	8000	
LASD-710-300-12/8°	2850	0	93	93	94	109	102	101	99	96	109
LASD-710-300-12/8°	2850	622	95	95	96	110	108	104	99	93	112
LASD-710-300-12/8°	2850	1243	100	100	99	113	105	102	96	91	112
LASD-710-300-12/8°	2850	1865	98	98	99	112	104	101	97	93	111
LASD-710-300-12/20°	2850	0	98	98	99	112	103	100	98	96	111
LASD-710-300-12/20°	2850	522	99	99	99	110	102	100	97	95	110
LASD-710-300-12/20°	2850	837	99	99	99	109	103	101	99	96	110
LASD-710-300-12/20°	2850	1048	102	102	102	109	108	106	102	97	113
LASD-710-300-12/32°	2850	0	105	105	105	113	107	104	100	97	113
LASD-710-300-12/32°	2850	626	105	105	104	111	105	102	99	95	111
LASD-710-300-12/32°	2850	941	104	104	103	111	104	102	99	96	111
LASD-710-300-12/32°	2850	1247	106	106	105	109	105	103	101	97	111
LASD-710-300-12/8°	1440	0	79	80	95	87	87	84	82	73	92
LASD-710-300-12/8°	1440	159	81	82	96	93	89	84	78	71	94
LASD-710-300-12/8°	1440	317	86	85	99	90	87	81	76	71	93
LASD-710-300-12/8°	1440	476	84	85	98	89	87	82	78	73	93
LASD-710-300-12/20°	1440	0	84	85	98	88	86	83	82	73	93
LASD-710-300-12/20°	1440	133	85	85	96	87	86	82	81	73	92
LASD-710-300-12/20°	1440	214	85	85	95	88	87	85	81	74	92
LASD-710-300-12/20°	1440	268	88	88	95	94	91	87	82	74	96
LASD-710-300-12/32°	1440	0	91	91	99	92	90	85	82	75	95
LASD-710-300-12/32°	1440	160	91	90	97	90	88	84	80	74	93
LASD-710-300-12/32°	1440	240	90	89	97	89	88	84	81	77	93
LASD-710-300-12/32°	1440	318	92	91	95	90	89	86	82	78	94

The sound power level ratings shown are in decibels referred to 10<sup>-12</sup> watts, calculated per AMCA International Standard 301. The A-weighted sound ratings shown have been calculated per AMCA International Standard 301. Values shown are for inlet L<sub>wi</sub> and L<sub>wi</sub>A sound power levels for Installation Type B : free inlet, ducted outlet.

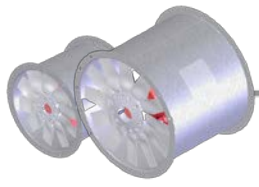

## LASD-710-300-12 50Hz

### Sound Data [dB]

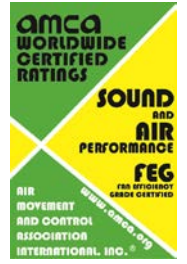

Model No.	N [RPM]	Ps [Pa]	Sound Power re 10 <sup>-12</sup> Watts Octave Band [Hz]								L <sub>wi</sub> A [dBA]
			63	125	250	500	1000	2000	4000	8000	
LASD-710-300-12/8°	960	0	70	79	86	78	76	74	68	59	82
LASD-710-300-12/8°	960	71	72	80	87	82	77	72	65	58	83
LASD-710-300-12/8°	960	141	76	83	90	79	75	69	64	59	84
LASD-710-300-12/8°	960	212	75	83	89	79	75	71	66	61	83
LASD-710-300-12/20°	960	0	75	83	89	78	75	73	68	59	83
LASD-710-300-12/20°	960	59	76	82	87	77	75	72	67	59	82
LASD-710-300-12/20°	960	95	76	81	86	78	77	74	68	61	82
LASD-710-300-12/20°	960	119	79	83	86	83	80	75	68	60	85
LASD-710-300-12/32°	960	0	82	86	90	82	78	74	69	62	85
LASD-710-300-12/32°	960	71	81	85	88	80	77	73	68	62	83
LASD-710-300-12/32°	960	107	80	84	88	79	77	73	70	66	83
LASD-710-300-12/32°	960	142	82	84	86	80	78	75	71	67	84
LASD-710-300-12/8°	720	0	65	80	72	72	69	67	58	49	74
LASD-710-300-12/8°	720	40	67	81	78	74	69	63	56	49	75
LASD-710-300-12/8°	720	79	70	84	75	72	66	61	56	51	74
LASD-710-300-12/8°	720	119	70	83	74	72	67	63	58	53	74
LASD-710-300-12/20°	720	0	70	83	73	71	68	67	58	49	74
LASD-710-300-12/20°	720	33	70	81	72	71	67	66	58	50	73
LASD-710-300-12/20°	720	53	70	80	73	72	70	66	59	52	74
LASD-710-300-12/20°	720	67	73	80	79	76	72	67	59	51	77
LASD-710-300-12/32°	720	0	76	84	77	75	70	67	60	53	76
LASD-710-300-12/32°	720	40	75	82	75	73	69	65	59	53	75
LASD-710-300-12/32°	720	60	74	82	74	73	69	66	62	58	75
LASD-710-300-12/32°	720	80	76	80	75	74	71	67	63	59	76

The sound power level ratings shown are in decibels referred to 10<sup>-12</sup> watts, calculated per AMCA International Standard 301. The A-weighted sound ratings shown have been calculated per AMCA International Standard 301. Values shown are for inlet L<sub>wi</sub> and L<sub>wi</sub>A sound power levels for Installation Type B : free inlet, ducted outlet.

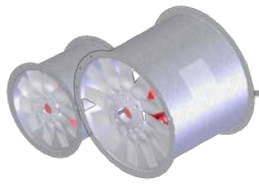

## LASD-800-300-6 50Hz

### Sound Data [dB]

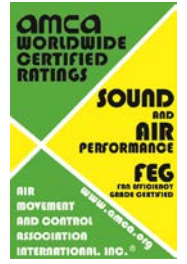

Model No.	N [RPM]	Ps [Pa]	Sound Power re 10 <sup>-12</sup> Watts								L <sub>Wi</sub> A [dBA]
			Octave Band [Hz]								
			63	125	250	500	1000	2000	4000	8000	
LASD-800-300-6/8°	2850	0	99	99	109	104	101	100	96	95	107
LASD-800-300-6/8°	2850	388	100	100	107	103	100	101	101	98	108
LASD-800-300-6/8°	2850	763	102	102	104	108	109	105	99	94	112
LASD-800-300-6/8°	2850	1142	104	104	112	109	105	102	99	96	111
LASD-800-300-6/20°	2850	0	107	107	116	110	106	103	98	95	112
LASD-800-300-6/20°	2850	344	107	107	115	109	104	101	97	94	111
LASD-800-300-6/20°	2850	688	107	107	113	107	103	101	97	95	110
LASD-800-300-6/20°	2850	1033	110	110	112	107	106	104	100	98	111
LASD-800-300-6/32°	2850	0	112	112	118	113	110	107	102	97	116
LASD-800-300-6/32°	2850	401	113	113	117	112	109	106	102	98	115
LASD-800-300-6/32°	2850	805	113	113	116	111	108	105	102	99	114
LASD-800-300-6/32°	2850	1131	113	113	114	110	107	105	103	99	113
LASD-800-300-6/8°	1440	0	84	94	89	86	85	81	80	73	90
LASD-800-300-6/8°	1440	99	85	92	88	85	86	86	83	74	92
LASD-800-300-6/8°	1440	195	87	89	93	94	90	84	79	72	95
LASD-800-300-6/8°	1440	291	89	97	94	90	87	84	81	75	93
LASD-800-300-6/20°	1440	0	92	101	95	91	88	83	80	73	94
LASD-800-300-6/20°	1440	88	92	100	94	89	86	82	79	73	93
LASD-800-300-6/20°	1440	176	92	98	93	88	86	82	80	74	92
LASD-800-300-6/20°	1440	264	95	97	92	91	89	85	83	77	94
LASD-800-300-6/32°	1440	0	97	103	98	95	92	87	82	78	97
LASD-800-300-6/32°	1440	102	98	102	97	94	91	87	83	79	97
LASD-800-300-6/32°	1440	205	98	101	96	93	90	87	84	80	96
LASD-800-300-6/32°	1440	289	98	99	95	92	90	88	84	80	96

The sound power level ratings shown are in decibels referred to 10<sup>-12</sup> watts, calculated per AMCA International Standard 301. The A-weighted sound ratings shown have been calculated per AMCA International Standard 301. Values shown are for inlet L<sub>Wi</sub> and L<sub>Wi</sub>A sound power levels for Installation Type B : free inlet, ducted outlet.



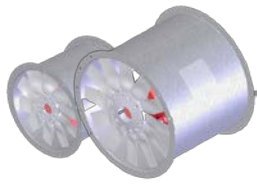

## LASD-800-300-6 50Hz

### Sound Data [dB]

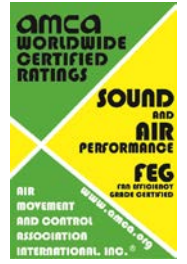

Model No.	N [RPM]	Ps [Pa]	Sound Power re 10 <sup>-12</sup> Watts Octave Band [Hz]								L <sub>wi</sub> A [dBA]
			63	125	250	500	1000	2000	4000	8000	
LASD-800-300-6/8°	960	0	85	85	78	77	74	71	69	59	80
LASD-800-300-6/8°	960	44	83	83	77	77	78	76	70	58	82
LASD-800-300-6/8°	960	87	80	82	86	83	78	72	67	58	84
LASD-800-300-6/8°	960	130	88	88	83	80	77	74	70	63	83
LASD-800-300-6/20°	960	0	92	92	83	81	77	72	69	59	83
LASD-800-300-6/20°	960	39	91	91	82	79	75	71	68	59	82
LASD-800-300-6/20°	960	78	89	89	81	78	75	72	69	62	81
LASD-800-300-6/20°	960	117	88	88	82	82	78	75	72	65	84
LASD-800-300-6/32°	960	0	94	94	87	85	81	75	71	67	87
LASD-800-300-6/32°	960	45	93	93	86	84	80	76	72	67	86
LASD-800-300-6/32°	960	91	92	92	85	83	80	77	73	68	86
LASD-800-300-6/32°	960	128	90	90	84	82	81	77	73	68	86
LASD-800-300-6/8°	720	0	79	74	71	70	66	65	58	48	72
LASD-800-300-6/8°	720	25	77	73	70	71	71	68	59	47	75
LASD-800-300-6/8°	720	49	74	78	79	75	69	64	57	48	76
LASD-800-300-6/8°	720	73	82	79	75	72	69	66	60	53	75
LASD-800-300-6/20°	720	0	86	80	76	73	68	65	58	48	75
LASD-800-300-6/20°	720	22	85	79	74	71	67	64	58	49	73
LASD-800-300-6/20°	720	44	83	78	73	71	67	65	59	52	73
LASD-800-300-6/20°	720	66	82	77	76	74	70	68	62	55	76
LASD-800-300-6/32°	720	0	88	83	80	77	72	67	63	59	79
LASD-800-300-6/32°	720	26	87	82	79	76	72	68	64	59	78
LASD-800-300-6/32°	720	51	86	81	78	75	72	69	65	60	78
LASD-800-300-6/32°	720	72	84	80	77	75	73	69	65	60	78

The sound power level ratings shown are in decibels referred to 10<sup>-12</sup> watts, calculated per AMCA International Standard 301. The A-weighted sound ratings shown have been calculated per AMCA International Standard 301. Values shown are for inlet L<sub>wi</sub> and L<sub>wi</sub>A sound power levels for Installation Type B : free inlet, ducted outlet.

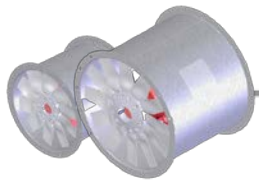

## LASD-800-300-12 50Hz

### Sound Data [dB]

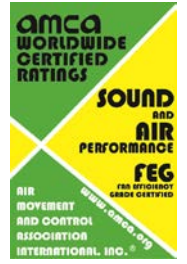

Model No.	N [RPM]	Ps [Pa]	Sound Power re 10 <sup>-12</sup> Watts Octave Band [Hz]								L <sub>wi</sub> A [dBA]
			63	125	250	500	1000	2000	4000	8000	
LASD-800-300-12/8°	2850	0	100	100	99	106	105	104	101	99	110
LASD-800-300-12/8°	2850	600	100	100	99	104	106	108	105	100	113
LASD-800-300-12/8°	2850	1183	104	104	109	114	110	105	101	95	115
LASD-800-300-12/8°	2850	1825	104	104	106	112	109	104	100	97	113
LASD-800-300-12/20°	2850	0	106	106	105	111	110	106	101	99	114
LASD-800-300-12/20°	2850	450	104	104	105	111	108	105	100	98	113
LASD-800-300-12/20°	2850	906	105	105	104	110	107	104	100	98	112
LASD-800-300-12/20°	2850	1356	107	107	106	112	113	111	107	101	117
LASD-800-300-12/32°	2850	0	111	111	111	115	112	109	104	99	117
LASD-800-300-12/32°	2850	475	111	111	110	114	112	108	104	99	116
LASD-800-300-12/32°	2850	950	110	110	109	113	111	108	104	99	115
LASD-800-300-12/32°	2850	1428	111	111	108	112	111	107	104	100	115
LASD-800-300-12/8°	1440	0	85	84	91	90	89	86	84	76	94
LASD-800-300-12/8°	1440	153	85	84	89	91	93	90	85	76	97
LASD-800-300-12/8°	1440	302	89	94	99	95	90	86	80	72	97
LASD-800-300-12/8°	1440	466	89	91	97	94	89	85	82	76	95
LASD-800-300-12/20°	1440	0	91	90	96	95	91	86	84	77	96
LASD-800-300-12/20°	1440	115	89	90	96	93	90	85	83	76	95
LASD-800-300-12/20°	1440	231	90	89	95	92	89	85	83	76	95
LASD-800-300-12/20°	1440	346	92	91	97	98	96	92	86	78	100
LASD-800-300-12/32°	1440	0	96	96	100	97	94	89	84	79	99
LASD-800-300-12/32°	1440	121	96	95	99	97	93	89	84	79	99
LASD-800-300-12/32°	1440	243	95	94	98	96	93	89	84	80	98
LASD-800-300-12/32°	1440	364	96	93	97	96	92	89	85	81	98

The sound power level ratings shown are in decibels referred to 10<sup>-12</sup> watts, calculated per AMCA International Standard 301. The A-weighted sound ratings shown have been calculated per AMCA International Standard 301. Values shown are for inlet L<sub>wi</sub> and L<sub>wi</sub>A sound power levels for Installation Type B : free inlet, ducted outlet.

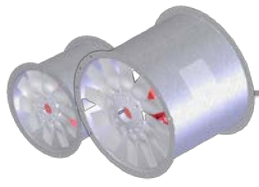

## LASD-800-300-12 50Hz

### Sound Data [dB]

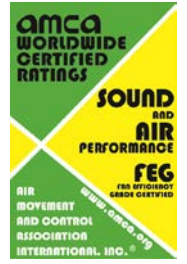

Model No.	N [RPM]	Ps [Pa]	Sound Power re 10 <sup>-12</sup> Watts								L <sub>wi</sub> A [dBA]
			Octave Band [Hz]								
			63	125	250	500	1000	2000	4000	8000	
LASD-800-300-12/8°	960	0	76	82	82	81	79	76	72	62	84
LASD-800-300-12/8°	960	68	76	80	81	84	84	78	72	62	87
LASD-800-300-12/8°	960	134	82	90	90	83	79	74	67	58	86
LASD-800-300-12/8°	960	207	81	88	88	82	78	75	70	62	85
LASD-800-300-12/20°	960	0	82	87	87	84	80	75	73	62	86
LASD-800-300-12/20°	960	51	81	87	87	83	79	74	72	61	85
LASD-800-300-12/20°	960	103	81	86	86	82	78	75	71	62	84
LASD-800-300-12/20°	960	154	83	88	89	89	85	80	73	64	90
LASD-800-300-12/32°	960	0	87	91	91	87	83	77	73	67	89
LASD-800-300-12/32°	960	54	87	90	90	86	82	77	73	67	88
LASD-800-300-12/32°	960	108	86	89	89	86	82	77	73	68	88
LASD-800-300-12/32°	960	162	86	88	88	85	82	78	74	69	87
LASD-800-300-12/8°	720	0	69	76	75	74	71	69	61	51	76
LASD-800-300-12/8°	720	38	69	74	76	78	75	70	61	51	79
LASD-800-300-12/8°	720	76	79	84	80	75	71	65	57	48	77
LASD-800-300-12/8°	720	116	76	82	79	74	70	67	61	53	77
LASD-800-300-12/20°	720	0	75	81	80	76	71	69	62	51	78
LASD-800-300-12/20°	720	29	75	81	78	75	70	68	61	50	77
LASD-800-300-12/20°	720	58	74	80	77	74	70	68	61	52	76
LASD-800-300-12/20°	720	87	76	82	83	81	77	71	63	54	82
LASD-800-300-12/32°	720	0	81	85	82	79	74	69	64	58	81
LASD-800-300-12/32°	720	30	80	84	82	78	74	69	64	58	80
LASD-800-300-12/32°	720	61	79	83	81	78	74	69	65	60	80
LASD-800-300-12/32°	720	91	78	82	81	77	74	70	66	61	80

The sound power level ratings shown are in decibels referred to 10<sup>-12</sup> watts, calculated per AMCA International Standard 301. The A-weighted sound ratings shown have been calculated per AMCA International Standard 301. Values shown are for inlet L<sub>wi</sub> and L<sub>wi</sub>A sound power levels for Installation Type B : free inlet, ducted outlet.

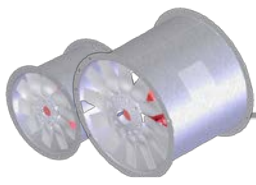

# Axial Smoke-exhaust Fan



LASD-900-300-6

50Hz

Sound Data [dB]

Model No.	N [RPM]	Ps [Pa]	Sound Power re $10^{-12}$ Watts								L <sub>WiA</sub> [dBA]
			Octave Band [Hz]								
			63	125	250	500	1000	2000	4000	8000	
LASD-900-300-6/8°	1440	0	82	93	89	87	87	85	88	78	93
LASD-900-300-6/8°	1440	108	84	91	88	87	91	90	91	79	97
LASD-900-300-6/8°	1440	216	86	91	98	97	93	88	86	78	98
LASD-900-300-6/8°	1440	324	87	97	95	92	90	88	84	79	96
LASD-900-300-6/20°	1440	0	91	99	95	91	89	86	89	80	96
LASD-900-300-6/20°	1440	192	92	97	93	90	88	86	84	80	94
LASD-900-300-6/20°	1440	253	94	96	93	93	91	89	87	82	97
LASD-900-300-6/20°	1440	304	96	96	98	100	98	93	88	83	102
LASD-900-300-6/32°	1440	0	97	102	98	95	93	90	87	83	99
LASD-900-300-6/32°	1440	130	97	102	97	94	92	90	88	84	98
LASD-900-300-6/32°	1440	226	98	100	96	93	93	92	88	84	98
LASD-900-300-6/32°	1440	334	98	98	95	93	93	91	88	84	98
LASD-900-300-6/8°	960	0	84	84	78	78	77	77	76	60	83
LASD-900-300-6/8°	960	48	82	82	78	80	83	82	78	61	87
LASD-900-300-6/8°	960	96	82	85	90	85	82	78	74	63	88
LASD-900-300-6/8°	960	144	88	88	85	82	80	77	73	68	85
LASD-900-300-6/20°	960	0	90	90	84	82	79	78	77	62	86
LASD-900-300-6/20°	960	85	88	88	82	81	79	77	74	69	84
LASD-900-300-6/20°	960	113	87	87	83	84	82	79	76	71	87
LASD-900-300-6/20°	960	135	87	88	91	91	87	82	77	72	92
LASD-900-300-6/32°	960	0	93	93	87	86	83	79	76	72	88
LASD-900-300-6/32°	960	58	93	93	86	85	83	80	77	73	88
LASD-900-300-6/32°	960	100	91	91	85	84	84	82	77	73	89
LASD-900-300-6/32°	960	148	89	89	85	84	84	81	77	73	88
LASD-900-300-6/8°	720	0	78	73	72	72	70	73	63	47	77
LASD-900-300-6/8°	720	27	76	73	72	76	75	76	64	47	81
LASD-900-300-6/8°	720	54	76	83	81	78	73	71	63	52	80
LASD-900-300-6/8°	720	81	82	80	77	75	73	69	64	59	78
LASD-900-300-6/20°	720	0	84	79	76	74	71	74	65	50	79
LASD-900-300-6/20°	720	48	82	77	75	73	71	69	65	60	77
LASD-900-300-6/20°	720	63	81	78	78	76	74	72	67	62	79
LASD-900-300-6/20°	720	76	81	83	85	83	78	73	68	63	84
LASD-900-300-6/32°	720	0	87	82	80	78	75	72	68	64	81
LASD-900-300-6/32°	720	32	87	82	79	77	75	73	69	65	81
LASD-900-300-6/32°	720	57	85	80	78	78	77	73	69	65	81
LASD-900-300-6/32°	720	84	83	80	78	78	76	73	69	65	81

The sound power level ratings shown are in decibels referred to  $10^{-12}$  watts, calculated per AMCA International Standard 301. The A-weighted sound ratings shown have been calculated per AMCA International Standard 301. Values shown are for inlet Lwi and LwiA sound power levels for Installation Type B : free inlet, ducted outlet.

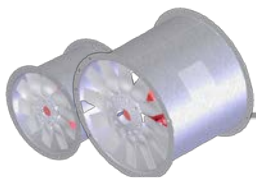

# Axial Smoke-exhaust Fan



LASD-900-300-12

50Hz

Sound Data [dB]

Model No.	N [RPM]	Ps [Pa]	Sound Power re $10^{-12}$ Watts								L <sub>w</sub> iA [dBA]
			Octave Band [Hz]								
			63	125	250	500	1000	2000	4000	8000	
LASD-900-300-12/8°	1440	0	81	82	92	90	90	88	91	81	96
LASD-900-300-12/8°	1440	144	80	81	91	92	96	94	92	81	100
LASD-900-300-12/8°	1440	288	84	88	93	98	97	92	89	79	101
LASD-900-300-12/8°	1440	432	88	89	100	96	93	89	86	79	98
LASD-900-300-12/20°	1440	0	90	89	98	94	92	89	93	82	99
LASD-900-300-12/20°	1440	144	89	89	97	93	91	89	92	82	98
LASD-900-300-12/20°	1440	288	89	88	97	94	92	90	90	83	98
LASD-900-300-12/20°	1440	432	91	92	103	102	100	96	91	84	105
LASD-900-300-12/32°	1440	0	97	95	102	98	95	92	92	85	101
LASD-900-300-12/32°	1440	144	96	94	100	97	94	92	89	85	100
LASD-900-300-12/32°	1440	288	96	93	99	97	94	92	89	85	100
LASD-900-300-12/32°	1440	432	97	95	99	97	96	94	90	86	101
LASD-900-300-12/8°	960	0	72	83	83	80	80	80	78	63	86
LASD-900-300-12/8°	960	64	71	82	82	85	87	84	78	63	90
LASD-900-300-12/8°	960	128	77	84	86	90	85	81	76	63	90
LASD-900-300-12/8°	960	192	80	91	91	85	82	78	74	66	88
LASD-900-300-12/20°	960	0	81	89	89	84	82	81	81	64	89
LASD-900-300-12/20°	960	64	80	88	88	83	81	81	79	64	88
LASD-900-300-12/20°	960	128	80	88	88	84	82	81	79	68	88
LASD-900-300-12/20°	960	192	82	94	94	93	90	84	78	71	94
LASD-900-300-12/32°	960	0	87	93	93	88	85	82	80	70	91
LASD-900-300-12/32°	960	64	86	91	91	87	84	82	78	72	90
LASD-900-300-12/32°	960	128	86	90	90	87	85	82	78	74	90
LASD-900-300-12/32°	960	192	87	90	90	88	87	84	79	75	91
LASD-900-300-12/8°	720	0	67	77	75	75	73	76	66	51	80
LASD-900-300-12/8°	720	36	66	76	77	81	79	77	66	51	83
LASD-900-300-12/8°	720	72	73	78	83	82	76	74	64	51	83
LASD-900-300-12/8°	720	108	74	85	81	78	74	71	64	56	80
LASD-900-300-12/20°	720	0	74	83	79	77	74	78	67	50	82
LASD-900-300-12/20°	720	36	74	82	78	76	74	77	67	52	81
LASD-900-300-12/20°	720	72	73	82	79	77	75	75	68	57	81
LASD-900-300-12/20°	720	108	77	88	87	85	81	75	69	62	87
LASD-900-300-12/32°	720	0	80	87	83	80	77	77	70	60	83
LASD-900-300-12/32°	720	36	79	85	82	79	77	74	69	63	82
LASD-900-300-12/32°	720	72	78	84	82	79	77	74	70	66	82
LASD-900-300-12/32°	720	108	80	84	82	81	79	75	71	67	84

The sound power level ratings shown are in decibels referred to  $10^{-12}$  watts, calculated per AMCA International Standard 301. The A-weighted sound ratings shown have been calculated per AMCA International Standard 301. Values shown are for inlet L<sub>w</sub>i and L<sub>w</sub>iA sound power levels for Installation Type B : free inlet, ducted outlet.

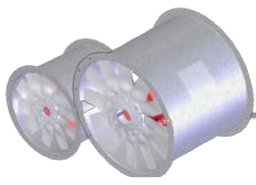

# Axial Smoke-exhaust Fan



LASD-1000-300-6

50Hz

Sound Data [dB]

Model No.	N [RPM]	Ps [Pa]	Sound Power re $10^{-12}$ Watts Octave Band [Hz]								L <sub>w</sub> iA [dBA]
			63	125	250	500	1000	2000	4000	8000	
LASD-1000-300-6/8°	1440	0	83	93	91	91	91	88	93	87	98
LASD-1000-300-6/8°	1440	108	84	92	90	90	91	89	94	86	98
LASD-1000-300-6/8°	1440	216	86	93	91	95	98	94	93	85	101
LASD-1000-300-6/8°	1440	324	89	97	98	96	93	91	87	83	99
LASD-1000-300-6/20°	1440	0	93	99	97	95	94	90	94	86	100
LASD-1000-300-6/20°	1440	117	93	99	96	94	93	89	90	84	98
LASD-1000-300-6/20°	1440	216	94	98	96	93	92	90	87	83	97
LASD-1000-300-6/20°	1440	359	98	97	95	94	95	93	90	86	99
LASD-1000-300-6/32°	1440	0	100	102	100	99	97	95	91	87	102
LASD-1000-300-6/32°	1440	148	100	102	100	97	96	94	92	87	102
LASD-1000-300-6/32°	1440	255	101	101	99	96	96	94	92	88	101
LASD-1000-300-6/32°	1440	336	102	102	101	99	99	96	93	88	104
LASD-1000-300-6/8°	960	0	84	84	82	82	81	81	83	72	88
LASD-1000-300-6/8°	960	48	83	83	81	81	82	82	83	69	88
LASD-1000-300-6/8°	960	96	84	84	83	88	87	83	81	70	91
LASD-1000-300-6/8°	960	144	88	89	89	86	83	80	76	72	88
LASD-1000-300-6/20°	960	0	90	90	87	86	84	82	83	69	90
LASD-1000-300-6/20°	960	52	90	90	86	85	83	80	79	70	88
LASD-1000-300-6/20°	960	96	89	89	86	84	82	79	76	72	87
LASD-1000-300-6/20°	960	159	88	88	86	85	85	82	79	75	90
LASD-1000-300-6/32°	960	0	93	93	91	90	87	84	80	76	92
LASD-1000-300-6/32°	960	66	93	93	90	88	87	84	81	76	92
LASD-1000-300-6/32°	960	113	92	92	89	87	87	84	81	77	91
LASD-1000-300-6/32°	960	149	93	93	92	90	89	85	82	77	93
LASD-1000-300-6/8°	720	0	78	76	76	76	73	78	72	61	82
LASD-1000-300-6/8°	720	27	77	75	75	76	74	79	71	57	82
LASD-1000-300-6/8°	720	54	78	76	80	83	78	78	70	59	84
LASD-1000-300-6/8°	720	81	82	83	81	78	76	72	68	64	81
LASD-1000-300-6/20°	720	0	84	82	80	79	75	79	71	57	83
LASD-1000-300-6/20°	720	29	84	81	79	78	74	75	69	60	81
LASD-1000-300-6/20°	720	54	83	81	78	77	75	72	68	64	80
LASD-1000-300-6/20°	720	90	82	80	79	80	78	75	71	67	82
LASD-1000-300-6/32°	720	0	87	85	84	82	80	76	72	68	85
LASD-1000-300-6/32°	720	37	87	85	82	81	79	77	72	67	84
LASD-1000-300-6/32°	720	64	86	84	81	81	79	77	73	69	84
LASD-1000-300-6/32°	720	84	87	86	84	84	81	78	73	68	86

The sound power level ratings shown are in decibels referred to  $10^{-12}$  watts, calculated per AMCA International Standard 301. The A-weighted sound ratings shown have been calculated per AMCA International Standard 301. Values shown are for inlet L<sub>w</sub>i and L<sub>w</sub>iA sound power levels for Installation Type B : free inlet, ducted outlet.



# Axial Smoke-exhaust Fan



LASD-1000-300-12

50Hz

Sound Data [dB]

Model No.	N [RPM]	Ps [Pa]	Sound Power re $10^{-12}$ Watts Octave Band [Hz]								L <sub>w</sub> A [dBA]
			63	125	250	500	1000	2000	4000	8000	
LASD-1000-300-12/8°	1440	0	83	83	94	92	93	92	95	88	100
LASD-1000-300-12/8°	1440	216	83	82	94	92	94	95	98	87	102
LASD-1000-300-12/8°	1440	432	87	88	97	101	99	94	94	84	103
LASD-1000-300-12/8°	1440	648	89	90	100	98	96	94	90	85	101
LASD-1000-300-12/20°	1440	0	95	93	101	98	96	93	97	89	103
LASD-1000-300-12/20°	1440	206	94	92	100	97	95	93	96	87	102
LASD-1000-300-12/20°	1440	359	95	92	101	97	97	95	94	87	102
LASD-1000-300-12/20°	1440	500	96	94	105	106	105	101	95	89	109
LASD-1000-300-12/32°	1440	0	101	97	104	101	100	96	95	88	105
LASD-1000-300-12/32°	1440	240	101	97	104	100	99	96	92	87	104
LASD-1000-300-12/32°	1440	395	101	97	104	99	98	96	93	88	103
LASD-1000-300-12/32°	1440	537	101	97	103	99	97	95	93	89	103
LASD-1000-300-12/8°	960	0	74	85	85	84	84	84	84	72	90
LASD-1000-300-12/8°	960	96	74	85	85	84	86	87	85	69	92
LASD-1000-300-12/8°	960	192	79	88	90	92	88	84	81	68	93
LASD-1000-300-12/8°	960	288	80	91	91	88	86	83	79	74	91
LASD-1000-300-12/20°	960	0	85	92	92	88	86	85	86	73	93
LASD-1000-300-12/20°	960	92	84	91	91	87	85	85	84	71	92
LASD-1000-300-12/20°	960	159	85	92	92	87	87	85	82	73	92
LASD-1000-300-12/20°	960	222	87	96	96	97	94	89	83	76	98
LASD-1000-300-12/32°	960	0	91	95	95	91	90	86	83	74	95
LASD-1000-300-12/32°	960	107	91	95	95	89	89	85	81	76	94
LASD-1000-300-12/32°	960	175	90	95	95	88	88	85	82	77	93
LASD-1000-300-12/32°	960	239	91	94	94	88	88	85	82	78	93
LASD-1000-300-12/8°	720	0	68	79	77	78	77	80	73	61	84
LASD-1000-300-12/8°	720	54	67	79	77	79	80	83	72	56	86
LASD-1000-300-12/8°	720	108	73	82	86	84	79	79	69	56	86
LASD-1000-300-12/8°	720	162	75	85	83	81	79	75	70	65	84
LASD-1000-300-12/20°	720	0	78	86	83	81	78	82	74	61	86
LASD-1000-300-12/20°	720	51	77	85	82	80	78	81	72	59	85
LASD-1000-300-12/20°	720	90	77	86	82	82	80	79	72	63	85
LASD-1000-300-12/20°	720	125	79	90	91	90	85	80	74	67	91
LASD-1000-300-12/32°	720	0	82	89	86	85	81	80	73	64	87
LASD-1000-300-12/32°	720	60	82	89	84	84	81	77	72	67	86
LASD-1000-300-12/32°	720	99	81	89	84	83	81	78	73	68	86
LASD-1000-300-12/32°	720	134	82	88	83	82	80	78	74	70	85

The sound power level ratings shown are in decibels referred to  $10^{-12}$  watts, calculated per AMCA International Standard 301. The A-weighted sound ratings shown have been calculated per AMCA International Standard 301. Values shown are for inlet L<sub>w</sub>i and L<sub>w</sub>iA sound power levels for Installation Type B : free inlet, ducted outlet.



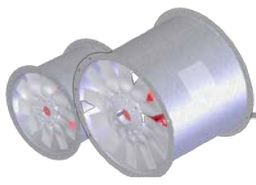

# Axial Smoke-exhaust Fan



LASD-1250-550-7

50Hz

Sound Data [dB]

Model No.	N [RPM]	Ps [Pa]	Sound Power re $10^{-12}$ Watts Octave Band [Hz]								L <sub>w</sub> iA [dBA]
			63	125	250	500	1000	2000	4000	8000	
LASD-1250-550-7/8°	1440	0	108	108	105	104	102	100	95	86	107
LASD-1250-550-7/8°	1440	313	105	105	104	103	102	101	96	87	107
LASD-1250-550-7/8°	1440	625	108	108	110	106	102	98	93	86	108
LASD-1250-550-7/8°	1440	938	109	109	108	104	101	98	95	89	107
LASD-1250-550-7/20°	1440	0	114	114	111	109	105	100	96	86	111
LASD-1250-550-7/20°	1440	243	113	113	110	108	104	99	95	86	110
LASD-1250-550-7/20°	1440	479	111	111	108	106	102	98	94	88	108
LASD-1250-550-7/20°	1440	715	110	110	112	112	108	103	98	91	113
LASD-1250-550-7/32°	1440	0	117	117	114	112	108	103	98	91	114
LASD-1250-550-7/32°	1440	243	115	115	113	111	107	102	97	92	112
LASD-1250-550-7/32°	1440	485	115	115	112	109	105	101	98	94	111
LASD-1250-550-7/32°	1440	728	113	113	110	107	105	102	99	95	111
LASD-1250-550-7/8°	960	0	99	99	95	95	92	89	82	72	97
LASD-1250-550-7/8°	960	139	96	96	94	94	93	91	83	73	97
LASD-1250-550-7/8°	960	278	99	100	101	95	91	87	80	73	97
LASD-1250-550-7/8°	960	417	100	100	97	94	91	88	84	77	96
LASD-1250-550-7/20°	960	0	105	105	101	99	93	89	83	73	100
LASD-1250-550-7/20°	960	108	104	104	100	98	92	88	82	72	99
LASD-1250-550-7/20°	960	213	102	102	98	95	91	87	82	75	97
LASD-1250-550-7/20°	960	318	101	102	104	102	96	92	86	79	103
LASD-1250-550-7/32°	960	0	108	108	104	102	96	91	86	79	103
LASD-1250-550-7/32°	960	108	106	106	103	100	95	90	86	80	102
LASD-1250-550-7/32°	960	216	106	106	101	98	94	91	87	83	101
LASD-1250-550-7/32°	960	323	104	104	99	98	95	92	88	84	100
LASD-1250-550-7/8°	720	0	93	90	89	87	85	80	71	64	89
LASD-1250-550-7/8°	720	78	90	89	88	87	86	81	72	64	90
LASD-1250-550-7/8°	720	156	93	95	91	87	83	78	71	65	89
LASD-1250-550-7/8°	720	235	94	93	89	86	83	80	74	69	89
LASD-1250-550-7/20°	720	0	99	96	94	90	85	81	71	65	92
LASD-1250-550-7/20°	720	61	98	95	93	89	84	80	71	64	91
LASD-1250-550-7/20°	720	120	96	93	91	87	83	79	73	67	89
LASD-1250-550-7/20°	720	179	95	97	97	93	88	83	76	71	95
LASD-1250-550-7/32°	720	0	102	99	97	93	88	83	76	70	95
LASD-1250-550-7/32°	720	61	100	98	96	92	87	82	77	72	94
LASD-1250-550-7/32°	720	121	100	97	94	90	86	83	79	75	93
LASD-1250-550-7/32°	720	182	98	95	92	90	87	84	80	76	93

The sound power level ratings shown are in decibels referred to  $10^{-12}$  watts, calculated per AMCA International Standard 301. The A-weighted sound ratings shown have been calculated per AMCA International Standard 301. Values shown are for inlet L<sub>w</sub>i and L<sub>w</sub>iA sound power levels for Installation Type B : free inlet, ducted outlet.



# Axial Smoke-exhaust Fan



LASD-1250-550-14

50Hz

Sound Data [dB]

Model No.	N [RPM]	Ps [Pa]	Sound Power re $10^{-12}$ Watts Octave Band [Hz]								L <sub>w</sub> iA [dBA]
			63	125	250	500	1000	2000	4000	8000	
LASD-1250-550-14/8°	1440	0	99	99	109	106	104	103	98	88	110
LASD-1250-550-14/8°	1440	568	100	100	106	107	106	103	96	88	110
LASD-1250-550-14/8°	1440	1142	102	102	114	109	104	100	95	88	111
LASD-1250-550-14/8°	1440	1710	104	104	112	109	104	101	97	92	111
LASD-1250-550-14/20°	1440	0	106	106	116	111	107	104	99	90	113
LASD-1250-550-14/20°	1440	280	104	104	115	110	107	103	97	89	113
LASD-1250-550-14/20°	1440	562	104	104	113	108	105	102	96	89	111
LASD-1250-550-14/20°	1440	842	103	103	113	110	107	104	98	92	113
LASD-1250-550-14/32°	1440	0	111	111	118	115	111	107	100	91	117
LASD-1250-550-14/32°	1440	263	110	110	117	113	110	105	99	91	115
LASD-1250-550-14/32°	1440	530	108	108	115	111	108	104	99	92	114
LASD-1250-550-14/32°	1440	842	106	106	113	110	107	103	99	95	112
LASD-1250-550-14/8°	960	0	90	93	100	95	95	92	84	75	99
LASD-1250-550-14/8°	960	252	91	93	98	98	96	91	82	75	100
LASD-1250-550-14/8°	960	508	93	96	105	97	93	88	83	76	100
LASD-1250-550-14/8°	960	760	95	97	103	97	94	90	86	80	100
LASD-1250-550-14/20°	960	0	97	100	107	100	97	93	86	77	103
LASD-1250-550-14/20°	960	124	95	98	106	99	96	92	84	77	102
LASD-1250-550-14/20°	960	250	95	97	104	97	95	91	84	78	101
LASD-1250-550-14/20°	960	374	94	97	104	100	97	93	86	80	102
LASD-1250-550-14/32°	960	0	102	104	109	104	100	95	87	78	106
LASD-1250-550-14/32°	960	117	101	103	108	102	99	93	85	78	105
LASD-1250-550-14/32°	960	235	99	101	106	100	98	92	87	80	103
LASD-1250-550-14/32°	960	374	97	99	104	99	96	92	88	83	102
LASD-1250-550-14/8°	720	0	84	94	91	89	88	83	73	67	92
LASD-1250-550-14/8°	720	142	85	91	92	91	88	81	73	67	93
LASD-1250-550-14/8°	720	286	87	99	94	89	85	80	73	68	92
LASD-1250-550-14/8°	720	428	89	97	94	89	86	82	77	72	92
LASD-1250-550-14/20°	720	0	91	101	96	92	89	84	75	70	95
LASD-1250-550-14/20°	720	70	89	100	95	92	88	82	74	70	94
LASD-1250-550-14/20°	720	140	89	98	93	90	87	81	74	70	93
LASD-1250-550-14/20°	720	211	88	98	95	92	89	83	77	72	94
LASD-1250-550-14/32°	720	0	96	103	100	96	92	85	76	70	98
LASD-1250-550-14/32°	720	66	95	102	98	95	90	83	76	70	96
LASD-1250-550-14/32°	720	132	93	100	96	93	89	84	77	72	95
LASD-1250-550-14/32°	720	211	91	98	95	92	88	84	80	75	94

The sound power level ratings shown are in decibels referred to  $10^{-12}$  watts, calculated per AMCA International Standard 301. The A-weighted sound ratings shown have been calculated per AMCA International Standard 301. Values shown are for inlet L<sub>w</sub>i and L<sub>w</sub>iA sound power levels for Installation Type B : free inlet, ducted outlet.

## Feet mounting

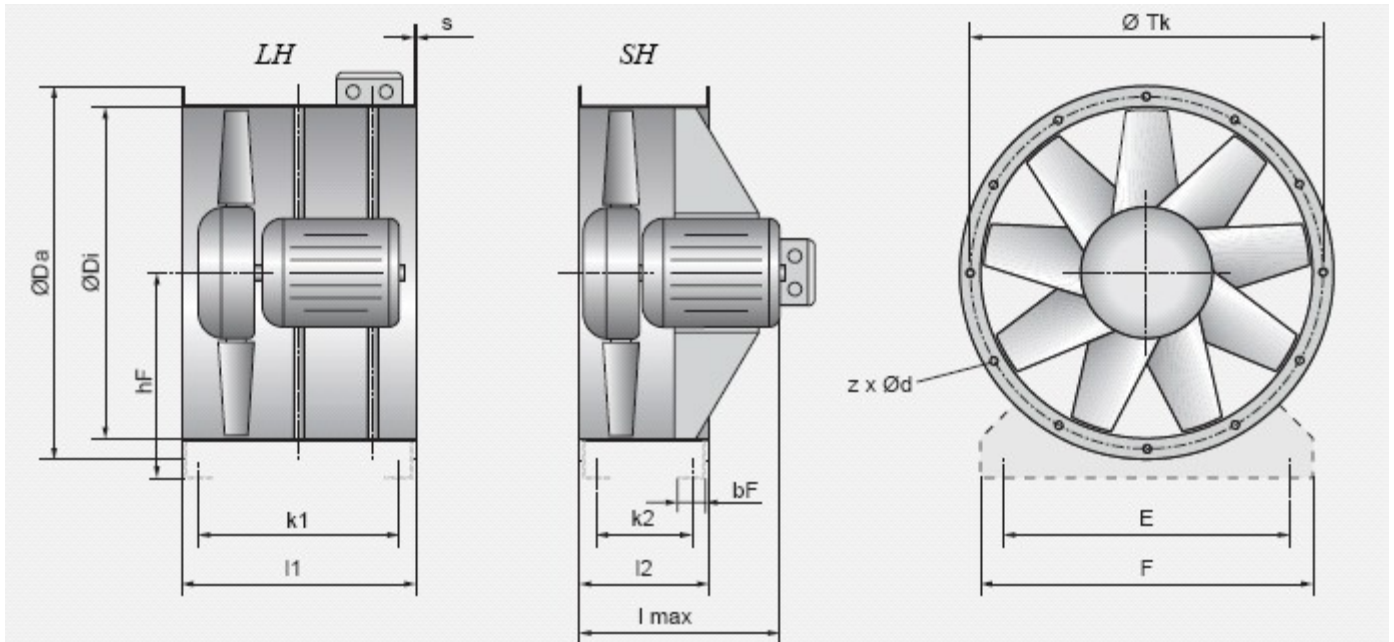

size	Di [mm]	Da [mm]	hF [mm]	z*d [mm]	Tk [mm]	E [mm]	F [mm]	bF [mm]
560	565	660	348	12*14	629	500	560	60
630	634	734	385	12*14	698	570	630	60
710	711	814	425	12*14	775	650	710	60
800	797	904	469	16*14	861	740	800	60
900	897	1002	516	16*14	958	840	900	60
1000	1003	1105	572	16*14	1067	900	960	60
1250	1250	1365	685	16*14	1320	1150	1210	60

size	LH				SH			LL				SL		
	S [mm]	k1 [mm]	l1 [mm]	Motor max.	k 2 [mm]	l2 [mm]	lmax [mm]	S [mm]	k1 [mm]	l1 [mm]	Motor max.	k 2 [mm]	l2 [mm]	lmax [mm]
560	3	454	520	132	149	225	460	3	434	520	132	150	225	460
630	3	534	600	132	299	275	550	3	404	520	132	149	225	550
710	3	584	650	160	222	300	575	3	404	520	132	149	225	575
800	3	634	700	180	212	300	575	3	404	520	132	139	225	575
900	4	632	700	180	212	300	575	3	404	520	132	214	300	575
1000	4	732	800	200	212	300	575	3	404	520	132	214	300	575
1250	4	932	1000											

## Feet mounting

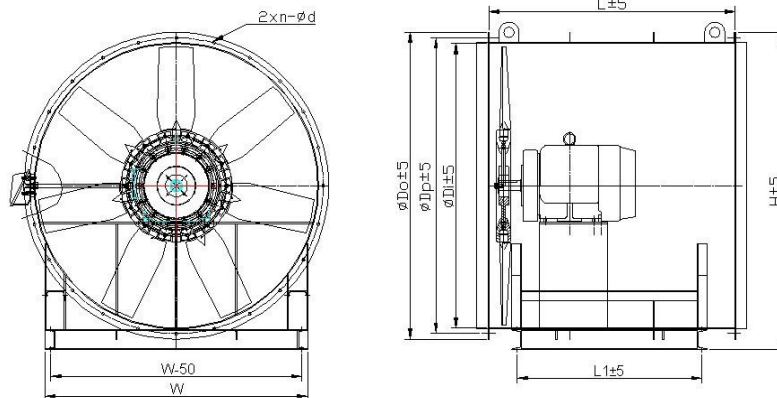

size	Di [mm]	Dp [mm]	Do [mm]	H [mm]	z*d [mm]	L [mm]	L1 [mm]	W [mm]
1250	1250	1320	1365	1392	16*14	1000	955	1250

## Ceiling Hanging

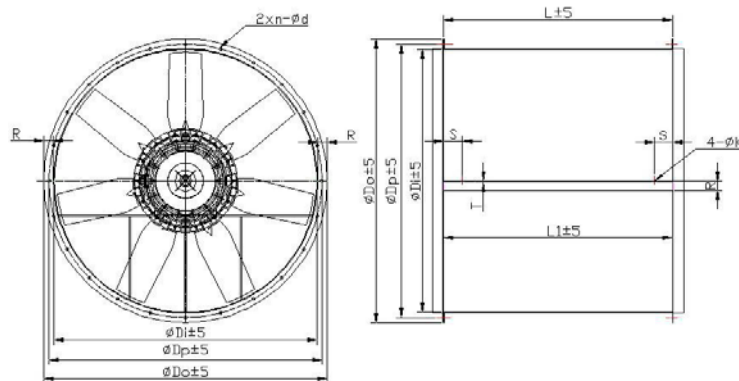

size	Di [mm]	Dp [mm]	Do [mm]	n*d	L [mm]	L1 [mm]	t [mm]	T [mm]	R [mm]	K [mm]	S [mm]	Motor Max.
560	565	629	660	12*14	520	514	3	5	50	14	100	
630	634	698	734	12*14	600	594	3	5	50	14	100	
710	711	775	814	12*14	650	644	3	5	50	14	100	
800	797	861	904	16*14	700	694	3	5	50	14	100	
900	894	958	1002	16*14	700	694	4	5	50	14	100	
1000	1003	1067	1105	16*14	800	794	4	5	50	14	100	
1250	1250	1320	1365	16*14	1000	992	4	5	100	14	100	

ED

LRK

GL-LASD

EV-LASD

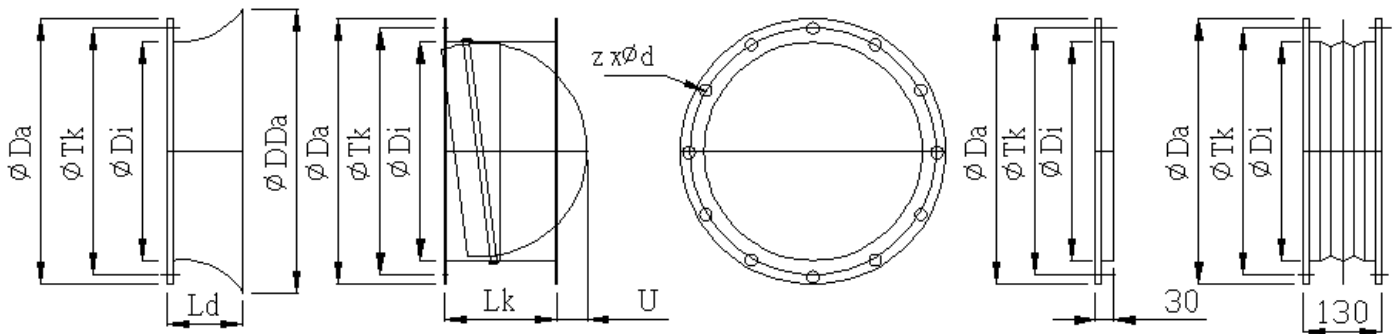

Size	Da [mm]	Di [mm]	Tk [mm]	z*d [mm]	DDa [mm]	Ld [mm]	Lk [mm]	U [mm]
560	660	565	629	12*14	667	135	185	110
630	734	634	698	16*14	775	135	210	125
710	814	711	775	16*14	816	170	310	155
800	904	797	861	16*14	915	200	330	195
900	1002	897	958	16*14	1015	250	330	220
1000	1105	1003	1067	16*14	1115	250	330	220
1250	1365	1250	1320	16*14	On demand			

SD

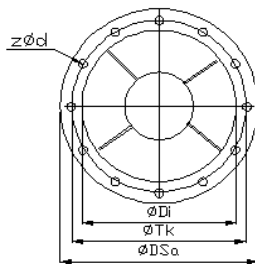
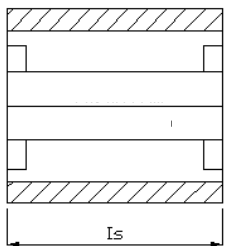

DSa [mm]	ls [mm]	[kg]	<b>suppression at</b> [Hz]								
			63 [dB]	125 [dB]	250 [dB]	500 [dB]	1k [dB]	2k [dB]	4k [dB]	8k [dB]	
560	765	1120	50	1	3	10	10	6	3	1	1
		630	34	1	1	5	5	3	2	1	1
630	835	1250	58	1	3	9	9	4	2	1	1
		750	48	1	2	6	6	3	2	1	1
710	915	1500	87	1	4	12	10	5	2	1	1
		800	62	1	3	7	5	2	1	1	1
800	1005	1600	98	1	4	11	7	4	2	1	1
		9000									
900		1800									
		1000									
1000		2000									
1250											

## THE FLOWTECH GROUP

### TAIPEI

19F-5, No.1, Baosheng Rd., Yonghe Dist., New Taipei City 234, Taiwan

Tel:+886-2-2232-8066 Fax:+886-2-2231-0285~6

E-mail: [flow.tech@msa.hinet.net](mailto:flow.tech@msa.hinet.net) Website: <http://www.flowtech.com.tw>

### Lab

No.102, Neihu 1st Rd., Dongshan Township, Yilan County 269, Taiwan

Tel:+886-39-610-891 Fax:+886-39-610-897

### Factory

No.658, Meilin Rd., Dongshan Township, Yilan County 269, Taiwan

Tel:+886-39-612-449 Fax:+886-39-615-843

**CNO.:CAT-LASD(50Hz) July 2016.**



TAIPEI

19F-5, No.1, Baosheng Rd., Yonghe Dist., New Taipei City, Taiwan

Tel: +886-2-2232-8066 Fax: +886-2-2231-0285~6

E-mail: [flow.tech@msa.hinet.net](mailto:flow.tech@msa.hinet.net)

Website: <http://www.flowtech.com.tw>

Agency :