

## CENTRIFUGAL WALL EXHAUSTERS

### Direct and Belt Driven

### Models VWDK and VWBK

#### DESIGNED AND ENGINEERED TO MEET INDUSTRY NEEDS

The Carnes Company centrifugal wall exhaust ventilator is the fan to use when the roof top ventilation is impractical or impossible. These direct and belt driven units mount to exterior walls and are designed so the air flow is away from the building.

The VW series wall exhauster is designed to compliment the configurations of the Carnes roof mounted ventilators - the VE series downblast and the VU series upblast fans.

The patented design of the diffuser support adds to the structural rigidity of the wall ventilator. The combination of the diffusers, the backwardly inclined

median airfoil wheel and the deep spun venturi allows fan operation at extended static pressures.

The deep spun venturi is precision matched to the wheel inlet to ensure maximum air flow along with protection from entry of adverse weather elements.

The air flow design of these fans has been thoroughly tested at Carnes' accredited laboratory.

Testing has also been conducted to ensure trouble-free startup and to ensure product durability and dependability of operation.

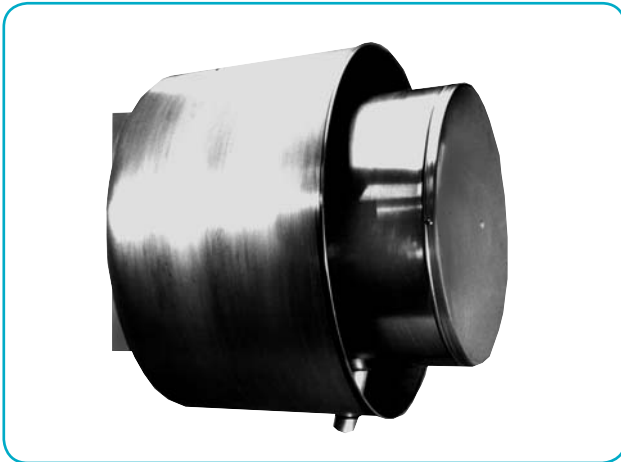

#### Direct Driven Model VWDK

Carnes direct drive centrifugal wall exhaust fans are available in six sizes with capacities from 150 to 4100 CFM. Certain direct drive units can be supplied with an optional electronic speed control which increases the fan's air flow flexibility. Direct driven fans require minimal maintenance and the one piece spun aluminum outer shroud is designed to be visually compatible with the Carnes spun aluminum roof mounted ventilators.

**Maximum exhaust temperature for continuous operation is 150°F.**

#### Belt Driven Model VWBK

The Carnes series VWBK belt driven wall exhaust fans are ideal for low to high air flows covering a range of static pressures, up to 2¾ inches, water gauge. This series features eight sizes with air performance capabilities of 225 to over 9,000 CFM. Structural integrity is enhanced by incorporating the diffuser support framework into the design of the fan. Housing construction is spun and shaped aluminum and utilizes a one or two piece outer shroud for rigidity and ease of maintenance.

**Maximum exhaust temperature for continuous operation is 200°F.**



### ▼ TYPICAL SPECIFICATIONS

Wall exhaust ventilators shall be of the centrifugal belt or direct driven type. The motor compartments shall be constructed of heavy gauge aluminum mounted on an independent support structure. The outer shroud shall have a rolled bead for added strength. The wheel and spun inlet venturi shall be a centrifugal design of non-sparking construction. For maximum performance and quiet, efficient operation, the wheel shall overlap the inlet venturi and have backward inclined median airfoil blades. The wheels shall be dynamically balanced to assure smooth and vibration-free rotation under maximum loading. The complete drive assembly, including the motor and the wheel, shall be mounted on vibration isolators. The motor and drives shall be factory mounted. All fans shall be test run prior to shipment.

#### VWBK BELT DRIVE SERIES

Motors and drives shall be isolated from the exhaust airstream. Air for cooling the motor shall be supplied to the internal motor compartment through a vent tube from a location free from discharge contaminants. Motors shall be of the heavy duty type with permanently lubricated, sealed ball bearings. Motors shall be readily accessible for maintenance. Wheel shaft shall be ground, polished, coated with a rust inhibitive finish and mounted in heavy duty, permanently sealed pillowblock ball bearings which are capable of 200,000 hours of life, average operation. Drives shall be sized at a minimum of 165% of driven horsepower. Drive belts shall be oil-resistant, non-static and be capable of 25,000 hours of life, average operation. Sheaves shall be fully machined cast iron, keyed and securely attached to the shafts. Variable pitch motor sheaves shall be standard.

#### VWDK DIRECT DRIVE SERIES

Motors shall be isolated from the exhaust airstream. Air for cooling the motor shall be supplied to the internal motor compartment through a vent tube from a location free from discharge contaminants. Motors shall be readily accessible for maintenance. Wheels to be furnished with integral fitting for wheel puller.

The motor shall be factory wired to the disconnect junction box and a disconnect switch shall be supplied. Field wiring of motor, disconnect and conduit are to be in accordance with electrical specifications and local codes. Heavy gauge welded galvanized birdscreen shall be furnished.

Horsepower and noise levels shall not exceed the published values and oversized motors will not be acceptable. Performance ratings shall be AMCA licensed for Air and Sound.

Centrifugal wall exhaust ventilators shall be Carnes Model VWBK, belt drive, sizes 06 through 24, or Model VWDK, direct drive, sizes 06 through 18, as manufactured at Carnes Company of Verona, Wisconsin.

#### AMCA LICENSED AIR and SOUND DATA

Licensed to bear the AMCA Seal for both air and sound.

The Carnes Company certifies that the Models VW shown herein are licensed to bear the AMCA Seal. The ratings shown are based on tests and procedures performed in accordance with AMCA Publication 211 and AMCA Publication 311 and comply with the requirements of the AMCA Certified Ratings Program.



#### UL OPTION

Models VWDK and VWBK are listed to UL Standard 705 and to CSA Standard C22.2 No. 113-12. File Number E27827. UL listing may be optional and must be specified when required.



**POWER  
VENTILATOR**

# CONSTRUCTION

## FAN HOUSING

- Constructed with heavy gauge aluminum.
- Designed for maximum weather protection, outer shroud and diffusers prevent the entrance of inclement weather.
- Outer shroud beaded for rigidity.
- Fan plate designed to prevent entrance of contaminated air and airborne particles into the motor compartment.
- Two piece motor cover design (lid and motor tube) allows easy access to motor, drives and bearings for maintenance.
- Drain opening.

## MOTOR/ELECTRICAL

- **UL** listing under Standard 705 available as option on most models.
- Motors are **UL** recognized components by nationally recognized manufacturers.
- Safety disconnect utility box mounted, switch and cover plate shipped loose for ease of field wiring.
- Sealed conduit chase complies with **NEC**, allows passage of electrical wire through curb cap into motor compartment.
- Motor through 3 HP mounted as standard.

### VWDK 10

*Units rotated for viewing purposes  
install with vent tube opening directed down*

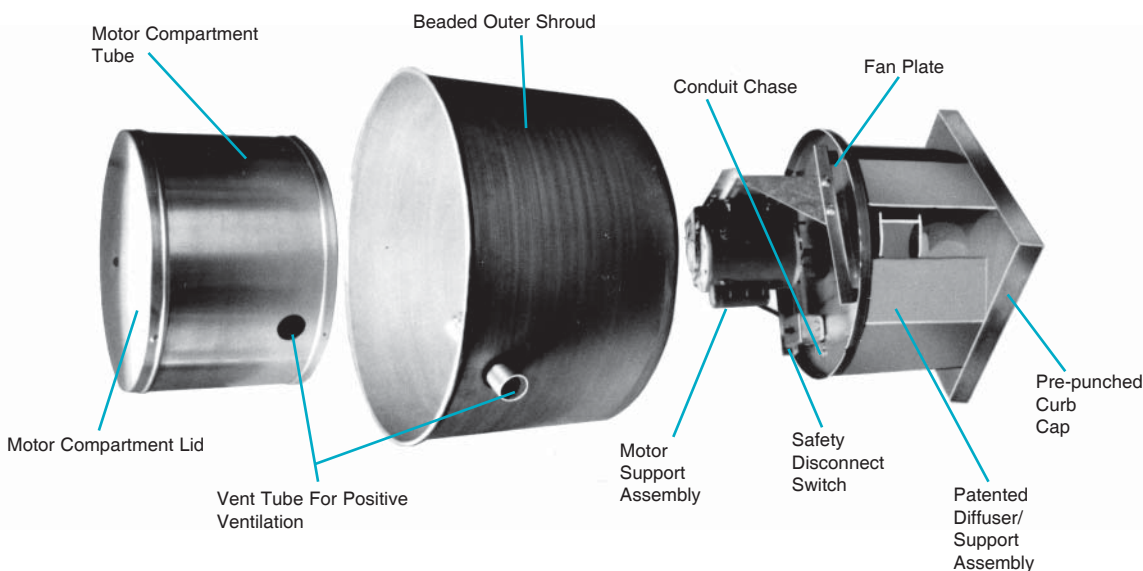

## MOTOR COMPARTMENT/TUBE

- Vent tube provides positive motor cooling to maximize motor life.
- Easily removable lid and tube utilize durable threaded fastener retainers.
- Opening around shaft sized to allow for optimum air passage to ensure proper motor compartment cooling.

## BIRDSCREEN

- 1/2" by 1/2" heavy gauge welded galvanized birdscreen attached to unit with easily removable fasteners.
- Birdscreen has a minimal effect on air and sound performance.

## MOTOR SUPPORT ASSEMBLY

- Bolted, heavy gauge material.
- Easily adjustable belt tension.
- Motor plate accommodates multiple motor frames.
- Isolated from fan plate to reduce vibration and noise transmission.
- Allows horizontal adjustment of wheel.
- Electrically grounded to meet **NEC** and **UL** requirements.

**Cent. Power Wall Vents**

## FEATURES

### BEARINGS/SHAFT

- Eccentric locking collar bearings standard on sizes 06-18.
- Dual bearings utilized to properly support the fan shaft.
- Prelubricated sealed, self-aligning rated at 200,000 hours average operation.
- Polished CRS fan shaft with rust inhibitive coating.

### DRIVES

- Selected for 165% of the motor horsepower.
- Adjustable V-belt drives with oil resistant non-static conducting belts.
- Factory preset fan RPM.
- Adjustable motor sheave allow for final air system balancing.

### VWBK 12

*Units rotated for viewing purposes  
install with vent tube opening directed down*

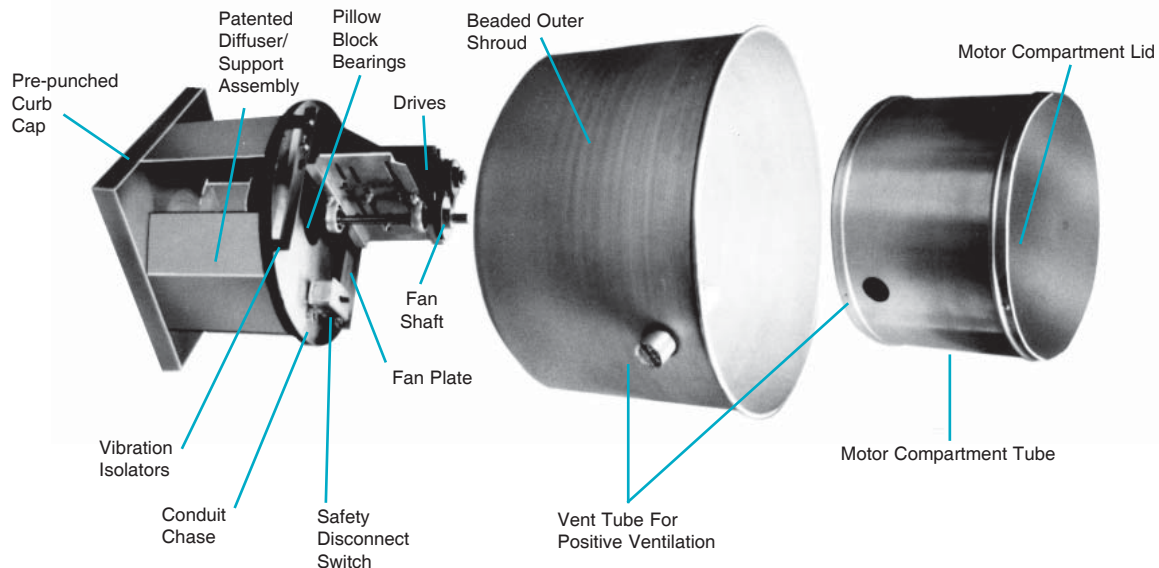

### WALL MOUNTING CAP

- One piece construction with fastened, overlapping corners to ensure strength.
- Pre-punched mounting holes for ease of installation.
- Support structure attached with self-sealing fasteners.
- The deep spun venturi is precision matched to the wheel inlet to ensure maximum air flow along with protection from entry of adverse weather elements.
- Mounting frame 1-1/2" by 1-1/2" angle to facilitate field installation.

### SUPPORT STRUCTURE

- Galvanized or aluminum patented diffuser provides structural integrity and protection against weather penetration.
- Self-sealing diffuser fasteners prevent leakage.

### WHEEL

- Backward inclined wheels constructed of non-corrosive or coated heavy-gauge material. Wheel sizes 6-24 are aluminum, above 24 are steel.
- Usage of cooling fins on fan wheel backplate draws cooling air down over the motor facilitating motor longevity while motor remains out of the airstream.
- Self-limiting power characteristics.
- Dynamically balanced and test run in each individual unit.

# VWDK 06

## DIRECT DRIVE

### PERFORMANCE DATA

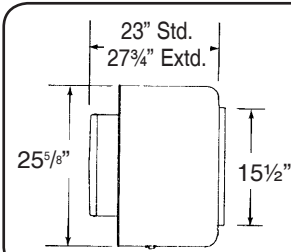

#### DESIGN DATA

Tip Speed = 2.75 x RPM  
 Unit Weight (less Motor) = 45 Lbs.  
 Wall Opening = 12" Sq.  
 Damper Size = 12" Sq.

RPM Range - Motor HP		RPM	STATIC PRESSURE, INCHES W.G.								
F3+ 1/20	J2+ 1/8		.000 CFM BHP SONES	.125 CFM BHP SONES	.250 CFM BHP SONES	.375 CFM BHP SONES	.500 CFM BHP SONES	.625 CFM BHP SONES	.750 CFM BHP SONES	1.000 CFM BHP SONES	1.250 CFM BHP SONES
<b>SPEED CONTROLLABLE MOTORS</b>		400	150 .01 .1								
		500	188 .01 .2								
		600	225 .01 .6								
		700	263 .01 1.1	119 .01 1.3							
		800	300 .01 1.7	193 .01 1.7							
		900	338 .01 2.3	248 .02 2.1							
		1000	376 .02 2.9	297 .02 2.7	179 .02 3.4						
		1075 *	404 .02 3.4	332 .03 3.2	237 .03 3.6						
		1100	413 .02 3.5	343 .03 3.3	253 .03 3.7						
		1200	451 .03 4.1	387 .04 4.0	314 .04 4.1	194 .04 5.0					
		1300	488 .04 4.8	429 .04 4.6	365 .05 4.5	278 .05 5.3					
		1400	526 .05 5.4	471 .05 5.3	414 .06 5.2	343 .06 5.7	239 .06 6.6				
		1500	563 .06 6.1	513 .07 6.0	461 .07 5.9	400 .07 6.1	320 .08 6.9				
		1600 *	601 .07 6.9	553 .08 6.8	505 .08 6.7	451 .09 6.6	385 .09 7.3	300 .09 8.2			
<b>ALL OTHER MOTORS</b>		1140 *	428 .03 3.7	361 .03 3.6	278 .03 3.8						
		1725 *	648 .09 7.8	604 .10 7.7	559 .10 7.6	512 .11 7.5	458 .11 7.8	391 .12 8.6	303 .12 9.5		

Performance certified is for installation type A - free inlet, free outlet. Speed (RPM) is nominal. Performance is based on actual speed of test.

\*\* To be Speed Controllable, motor must have 115/1 ODP. Other voltages and enclosures are non-speed controllable.

\* Base Unit - As run motor speeds.

+ RPM range capable with solid state speed control.

Performance ratings do not include the effects of accessories.

The sound power level ratings shown are in decibels, referred to 10<sup>-12</sup> watts calculated per AMCA Standard 301. Values shown are for inlet L<sub>Wj</sub> sound power levels for installation Type A free inlet, free outlet. Ratings do not include the effects of duct end correction.

The sound ratings shown are loudness values in fan sones at 5 feet (1.5m) in a hemispherical free field calculated per AMCA Standard 301. Values shown are for installation Type A, free inlet hemispherical sone levels.

#### VWDK 06 AIR PERFORMANCE

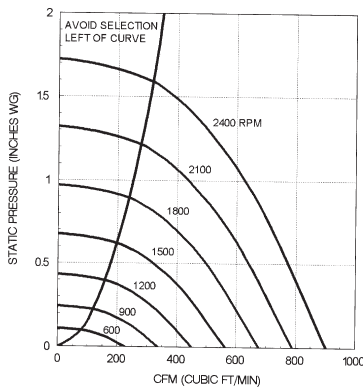

#### VWDK 06 SOUND PERFORMANCE

RPM	SP	SOUND POWER RE 10 <sup>-12</sup> WATTS								
		OCTAVE BANDS								
		1	2	3	4	5	6	7	8	LWA
1075	.000	50	57	51	52	48	49	43	39	55
	.125	54	56	52	51	48	47	43	38	54
	.375	61	63	56	58	53	50	45	41	59
1600	.000	65	65	66	62	59	57	55	50	65
	.250	66	66	65	62	59	57	54	50	65
	.375	66	67	65	62	59	56	54	49	65
	.500	68	69	67	63	61	58	54	50	66
	.625	71	71	69	65	63	59	56	51	68
	.750	73	74	71	67	65	61	57	52	70

Cent. Power Wall Vents



# VWDK 08

## DIRECT DRIVE

### PERFORMANCE DATA

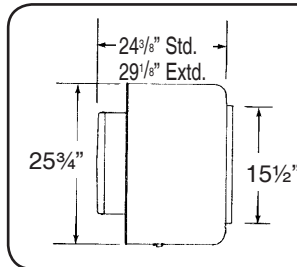

### DESIGN DATA

Tip Speed = 2.75 x RPM  
 Unit Weight (less Motor) = 45 Lbs.  
 Wall Opening = 12" Sq.  
 Damper Size = 12" Sq.

RPM Range - Motor HP		RPM	STATIC PRESSURE, INCHES W.G.								
F3+ 1/20	J2+ 1/8		.000	.125	.250	.375	.500	.625	.750	1.000	1.250
			CFM BHP SONES	CFM BHP SONES	CFM BHP SONES	CFM BHP SONES	CFM BHP SONES	CFM BHP SONES	CFM BHP SONES	CFM BHP SONES	CFM BHP SONES
<b>SPEED CONTROLLABLE MOTORS</b>		600	331 .01 2.0								
		675	373 .01 2.6	193 .01 1.4							
		750	414 .01 3.1	267 .01 2.0							
		825	455 .01 3.7	328 .02 2.6							
		900	497 .02 4.2	385 .02 3.2	176 .02 2.8						
		1000	552 .03 5.0	455 .03 4.0	321 .03 3.5						
		1075 *	593 .03 5.6	504 .04 4.7	389 .04 4.2						
		1175	649 .04 6.4	568 .05 5.6	470 .05 5.0	340 .05 4.7					
		1250	690 .05 7.1	614 .06 6.3	527 .06 5.6	420 .06 5.4					
		1325	731 .06 7.7	661 .07 7.0	582 .07 6.4	484 .07 6.0	348 .08 5.9				
		1400	773 .07 8.3	706 .08 7.7	635 .08 7.1	546 .09 6.7	439 .09 6.5				
		1475	814 .09 9.0	751 .09 8.4	684 .10 7.8	603 .10 7.4	512 .10 7.2	379 .10 7.1			
		1550	856 .10 9.7	795 .11 9.1	732 .11 8.6	660 .12 8.1	576 .12 7.9	474 .12 7.7	280 .12 7.8		
		1600 *	883 .11 10.2	825 .12 9.6	764 .12 9.1	696 .13 8.6	617 .13 8.4	527 .13 8.2	390 .13 8.2		
<b>ALL OTHER MOTORS</b>		1140 *	629 .04 6.1	546 .04 5.3	443 .05 4.7	290 .05 4.5					
		1725 *	952 .14 11.5	898 .14 10.9	842 .15 10.4	784 .16 9.9	713 .16 9.5	637 .17 9.4	548 .17 9.3		

Performance certified is for installation type A - free inlet, free outlet.  
 Speed (RPM) is nominal. Performance is based on actual speed of test.

\*\* To be Speed Controllable, motor must have 115/1 ODP. Other voltages and enclosures are non-speed controllable.

\* Base Unit - As run motor speeds.

+ RPM range capable with solid state speed control.

Performance ratings do not include the effects of accessories.

The sound power level ratings shown are in decibels, referred to 10<sup>-12</sup> watts calculated per AMCA Standard 301. Values shown are for inlet L<sub>W</sub> sound power levels for installation Type A free inlet, free outlet. Ratings do not include the effects of duct end correction.

The sound ratings shown are loudness values in fan sones at 5 feet (1.5m) in a hemispherical free field calculated per AMCA Standard 301. Values shown are for installation Type A, free inlet hemispherical sone levels.

### VWDK 08 AIR PERFORMANCE

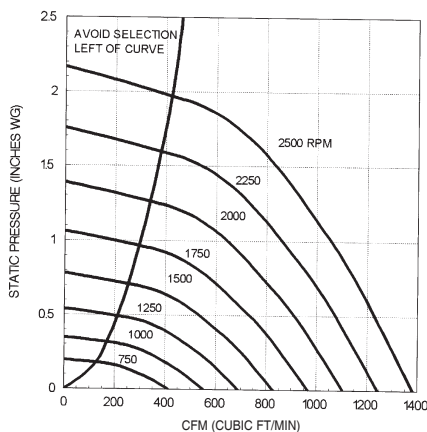

### VWDK 08 SOUND PERFORMANCE

RPM	SP	SOUND POWER RE 10 <sup>-12</sup> WATTS								LWA
		OCTAVE BANDS								
		1	2	3	4	5	6	7	8	
1075	.000	56	68	57	54	50	50	52	53	60
	.125	57	64	54	53	49	49	49	49	58
	.375	58	60	53	53	51	51	47	43	57
1600	.000	74	73	74	66	61	59	60	61	70
	.250	74	71	71	64	61	58	58	58	68
	.375	74	71	70	63	60	58	57	57	67
	.500	73	71	69	63	60	58	57	56	67
	.625	72	70	69	63	61	60	58	55	67
	.750	72	70	68	63	61	60	58	54	68

# VWDK 10

## DIRECT DRIVE

### PERFORMANCE DATA

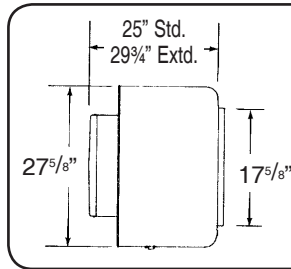

#### DESIGN DATA

Tip Speed = 3.27 x RPM  
 Unit Weight (less Motor) = 50 Lbs.  
 Wall Opening = 14" Sq.  
 Damper Size = 14" Sq.

RPM Range - Motor HP	RPM	STATIC PRESSURE, INCHES W.G.																	
		.000		.125		.250		.375		.500		.625		.750		1.000		1.250	
		CFM	BHP	CFM	BHP	CFM	BHP	CFM	BHP	CFM	BHP	CFM	BHP	CFM	BHP	CFM	BHP	CFM	BHP
SPEED CONTROLLABLE MOTORS	550	520	.01	277	.01														
	700	662	.02	500	.03														
	800	757	.03	620	.04	432	.04												
	825 *	781	.04	648	.04	477	.04												
	900	852	.05	731	.05	589	.06	355	.06										
	975	923	.06	813	.07	689	.07	521	.07										
	1050	994	.08	893	.08	782	.09	644	.09	439	.09								
	1075 *	1017	.08	919	.09	812	.10	681	.10	506	.10								
	1175	1112	.11	1023	.12	926	.12	819	.13	687	.13	494	.13						
	1275	1206	.14	1124	.15	1037	.15	944	.16	836	.17	702	.17	508	.16				
	1375	1301	.17	1225	.18	1145	.19	1061	.20	969	.21	861	.21	730	.21				
	1500	1419	.22	1350	.23	1279	.24	1202	.25	1124	.26	1036	.27	933	.27	662	.26		
	1575	1490	.26	1424	.27	1357	.28	1284	.29	1211	.30	1131	.31	1044	.31	819	.32	295	.26
	1625 *	1538	.28	1473	.29	1409	.31	1339	.32	1268	.33	1193	.34	1112	.34	910	.35	584	.33
ALL OTHER MOTORS	1140 *	1079	.10	987	.11	886	.11	775	.12	627	.12	375	.11						
	1725 *	1632	.34	1572	.35	1511	.36	1447	.37	1380	.39	1313	.40	1239	.40	1067	.41	850	.41

Performance certified is for installation type A - free inlet, free outlet.  
 Speed (RPM) is nominal. Performance is based on actual speed of test.  
**\*\* To be Speed Controllable, motor must have 115/1 ODP. Other voltages and enclosures are non-speed controllable.**  
 \* Base Unit - As run motor speeds.  
 + RPM range capable with solid state speed control.  
 Performance ratings do not include the effects of accessories.

The sound power level ratings shown are in decibels, referred to 10<sup>-12</sup> watts calculated per AMCA Standard 301. Values shown are for inlet L<sub>Wj</sub> sound power levels for installation Type A free inlet, free outlet. Ratings do not include the effects of duct end correction.

The sound ratings shown are loudness values in fan sones at 5 feet (1.5m) in a hemispherical free field calculated per AMCA Standard 301. Values shown are for installation Type A, free inlet hemispherical sone levels.

### VWDK 10 AIR PERFORMANCE

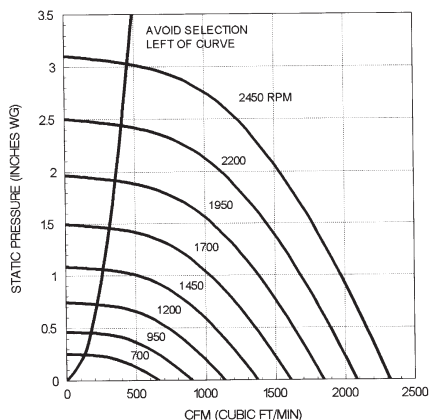

### VWDK 10 SOUND PERFORMANCE

RPM	SP	SOUND POWER RE 10 <sup>-12</sup> WATTS								
		OCTAVE BANDS								
		1	2	3	4	5	6	7	8	LWA
825	.000	54	60	55	52	52	52	44	37	57
	.125	58	58	53	50	50	49	42	35	55
	.375	58	57	52	49	49	49	45	40	55
1075	.000	61	65	64	59	57	59	53	45	64
	.250	65	64	62	57	55	56	50	44	62
	.500	65	63	60	56	55	56	52	48	62
1625	.000	76	73	78	72	68	67	66	59	75
	.500	75	77	76	70	66	64	63	57	74
	1.000	72	77	75	69	65	64	64	59	73

# VWDK 12

## DIRECT DRIVE

### PERFORMANCE DATA

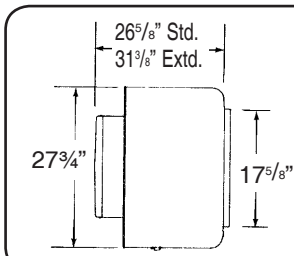

#### DESIGN DATA

Tip Speed = 3.27 x RPM  
 Unit Weight (less Motor) = 50 Lbs.  
 Wall Opening = 14" Sq.  
 Damper Size = 14" Sq.

RPM Range - Motor HP	RPM	STATIC PRESSURE, INCHES W.G.											
		.000	.125	.250	.375	.500	.625	.750	1.000	1.250			
F4+ 1/20	J3+ 1/8	M2+ 1/3	P2+ 1/2	CFM BHP SONES	CFM BHP SONES	CFM BHP SONES	CFM BHP SONES	CFM BHP SONES	CFM BHP SONES	CFM BHP SONES	CFM BHP SONES	CFM BHP SONES	CFM BHP SONES
SPEED CONTROLLABLE MOTORS**	550				661 .01 2.0	386 .02 1.6							
	700				841 .03 3.7	657 .03 3.2	186 .02 3.1						
	800				961 .04 5.0	804 .05 4.5	593 .05 4.2						
	825 *				991 .05 5.2	839 .05 4.8	642 .05 4.4						
	900				1081 .06 6.0	941 .06 5.6	782 .07 5.2	513 .06 5.2					
	975				1171 .08 6.9	1042 .08 6.5	906 .09 6.1	716 .09 6.0					
	1050				1261 .09 7.9	1141 .10 7.4	1023 .11 7.1	862 .11 6.9	631 .10 6.9				
	1075 *				1291 .10 8.2	1173 .11 7.8	1059 .11 7.4	910 .12 7.2	702 .11 7.2				
	1175				1411 .13 9.6	1303 .14 9.2	1198 .15 8.8	1078 .15 8.6	924 .15 8.5	708 .15 8.5			
	1275				1532 .17 11.2	1431 .18 10.8	1334 .18 10.4	1238 .19 10.0	1110 .19 9.9	957 .20 9.8	734 .18 9.9		
	1375				1652 .21 12.9	1559 .22 12.5	1468 .23 12.1	1379 .24 11.7	1275 .24 11.5	1150 .24 11.5	1005 .24 11.5		
	1500				1800 .27 15.1	1716 .28 14.8	1633 .29 14.4	1551 .30 14.1	1469 .31 13.9	1364 .31 13.7	1248 .32 13.7	935 .31 13.9	
	1575				1892 .32 16.5	1810 .33 16.3	1731 .34 16.0	1652 .35 15.5	1574 .36 15.3	1486 .36 15.2	1382 .37 15.1	1135 .37 15.2	525 .28 15.4
	1625 *				1952 .35 17.3	1873 .36 17.1	1795 .37 16.8	1719 3.8 16.3	1644 .39 16.1	1565 .40 15.9	1465 .40 15.8	1235 .40 15.9	863 .37 16.0
ALL OTHER MOTORS	1140 *			1369 .12 9.1	1258 .13 8.7	1150 .13 8.3	1021 .14 8.1	855 .14 8.0	573 .12 8.0				
	1725 *			2072 .42 18.7	1997 .43 18.4	1924 .44 18.1	1852 .45 17.7	1781 .46 17.4	1710 .47 17.2	1627 .48 17.0	1428 .48 16.9	1180 .48 17.1	

Performance certified is for installation type A - free inlet, free outlet. Speed (RPM) is nominal. Performance is based on actual speed of test.

\*\* To be Speed Controllable, motor must have 115/1 ODP. Other voltages and enclosures are non-speed controllable.

\* Base Unit - As run motor speeds.

+ RPM range capable with solid state speed control.

Performance ratings do not include the effects of accessories.

The sound power level ratings shown are in decibels, referred to 10<sup>-12</sup> watts calculated per AMCA Standard 301. Values shown are for inlet L<sub>Wj</sub> sound power levels for installation Type A free inlet, free outlet. Ratings do not include the effects of duct end correction.

The sound ratings shown are loudness values in fan sones at 5 feet (1.5m) in a hemispherical free field calculated per AMCA Standard 301. Values shown are for installation Type A, free inlet hemispherical sone levels.

### VWDK 12 AIR PERFORMANCE

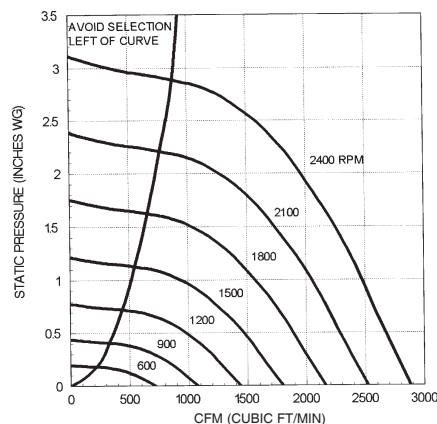

### VWDK 12 SOUND PERFORMANCE

RPM	SP	SOUND POWER RE 10 <sup>-12</sup> WATTS								
		OCTAVE BANDS								
		1	2	3	4	5	6	7	8	LWA
825	.000	65	64	60	54	59	55	45	35	62
	.125	65	63	59	53	57	51	45	38	60
	.375	67	61	59	51	52	51	46	42	58
1075	.000	68	72	69	63	63	62	55	45	69
	.250	68	72	68	62	60	59	53	47	67
	.500	63	71	68	61	58	57	54	48	66
1625	.000	72	85	82	77	70	74	69	60	80
	.500	71	85	81	76	68	72	66	60	79
	1.000	73	86	81	76	67	68	66	60	78



# VWDK 15

## DIRECT DRIVE

### PERFORMANCE DATA

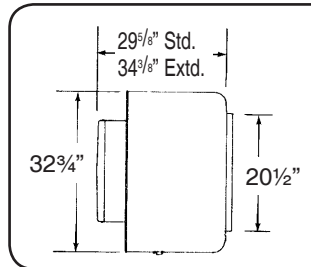

#### DESIGN DATA

Tip Speed = 4.06 x RPM  
 Unit Weight (less Motor) = 75 Lbs.  
 Wall Opening = 17" Sq.  
 Damper Size = 17" Sq.

RPM Range - Motor HP	RPM	STATIC PRESSURE, INCHES W.G.												
		K4+ 1/6		M3+ 1/3		.000	.125	.250	.375	.500	.625	.750	1.000	1.250
		CFM BHP	SONES	CFM BHP	SONES	CFM BHP	SONES	CFM BHP	SONES	CFM BHP	SONES	CFM BHP	SONES	CFM BHP
SPEED CONTROLLABLE MOTORS	450	993 .02	2.6	655 .03	2.9									
	500	1103 .03	3.3	815 .04	3.6									
	550	1214 .04	4.1	961 .05	4.3	441 .04	4.6							
	600	1324 .06	5.0	1098 .06	5.1	796 .07	5.3							
	650	1434 .07	5.9	1230 .08	6.0	973 .08	6.1							
	700	1545 .09	6.8	1359 .10	6.8	1132 .10	6.9	787 .10	7.2					
	750	1655 .11	7.7	1485 .12	7.7	1279 .13	7.8	1029 .12	8.0					
	800	1765 .14	8.7	1606 .15	8.7	1422 .15	8.7	1206 .16	8.9	854 .15	9.1			
	825 *	1820 .15	9.2	1666 .16	9.2	1490 .17	9.2	1288 .17	9.3	1002 .17	9.5			
	875	1931 .18	10.3	1785 .19	10.2	1623 .20	10.2	1439 .20	10.2	1221 .21	10.4	778 .18	10.5	
	925	2041 .21	11.4	1904 .22	11.2	1755 .23	11.2	1585 .24	11.2	1396 .24	11.4	1135 .24	11.6	
	975	2151 .25	12.5	2021 .26	12.4	1884 .27	12.3	1729 .28	12.2	1555 .28	12.4	1353 .28	12.6	1002 .26
	1025	2262 .29	13.6	2138 .30	13.5	2011 .31	13.4	1864 .32	13.3	1704 .32	13.4	1529 .33	13.6	1307 .33
1075 *	2372 .33	14.8	2254 .34	14.7	2135 .35	14.6	1997 .36	14.5	1850 .37	14.5	1693 .38	14.6	1507 .38	
ALL OTHER MOTORS	1140 *	2525 .37	13.3	2410 .38	12.8	2292 .39	12.3	2155 .40	11.9	2006 .41	11.6	1842 .42	11.4	1666 .42
														1084 .38
														11.2

Performance certified for installation type A - free inlet, free outlet.  
 Speed (RPM) is nominal. Performance is based on actual speed of test.  
**\*\* To be Speed Controllable, motor must have 115/1 ODP. Other voltages and enclosures are non-speed controllable.**  
 \* Base Unit - As run motor speeds.  
 + RPM range capable with solid state speed control.  
 Performance ratings do not include the effects of accessories.

The sound power level ratings shown are in decibels, referred to 10<sup>-12</sup> watts calculated per AMCA Standard 301. Values shown are for inlet L<sub>Wf</sub> sound power levels for installation Type A free inlet, free outlet. Ratings do not include the effects of duct end correction.

The sound ratings shown are loudness values in fan sones at 5 feet (1.5m) in a hemispherical free field calculated per AMCA Standard 301. Values shown are for installation Type A, free inlet hemispherical sone levels.

### VWDK 15 AIR PERFORMANCE

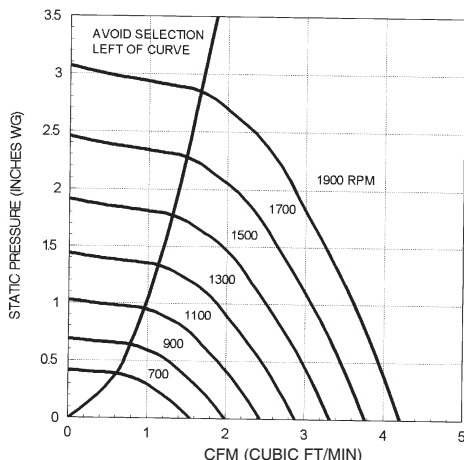

### VWDK 15 SOUND PERFORMANCE

RPM	SP	SOUND POWER RE 10 <sup>-12</sup> WATTS								
		OCTAVE BANDS								LWA
		1	2	3	4	5	6	7	8	
825	.000	74	76	73	68	63	60	54	46	70
	.125	73	76	73	68	64	60	54	47	70
	.250	73	75	72	69	64	60	54	49	71
	.500	73	74	72	69	66	61	56	51	71
	.750	73	74	72	69	66	61	57	51	71
1075	.000	81	81	81	76	70	68	62	55	78
	.250	80	81	80	76	71	67	62	56	78
	.500	80	80	80	77	72	67	63	57	78
	.750	81	80	80	77	73	68	64	58	78
	1.000	81	79	79	77	73	69	64	59	79

# VWDK 18

## DIRECT DRIVE

### PERFORMANCE DATA

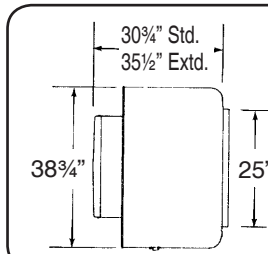

### DESIGN DATA

Tip Speed = 4.94 x RPM  
 Unit Weight (less Motor) = 95 Lbs.  
 Wall Opening = 22" Sq.  
 Damper Size = 22" Sq.

RPM Range - Motor HP		RPM	STATIC PRESSURE, INCHES W.G.										
M4+ 1/3	*R3+ 3/4		.000	.125	.250	.375	.500	.625	.750	1.000	1.250		
			CFM BHP SONES	CFM BHP SONES	CFM BHP SONES	CFM BHP SONES	CFM BHP SONES	CFM BHP SONES	CFM BHP SONES	CFM BHP SONES	CFM BHP SONES	CFM BHP SONES	CFM BHP SONES
<b>SPEED CONTROLLABLE MOTORS</b>		600	2266 .14 6.2	1942 .15 5.4	1538 .14 4.8	955 .12 4.5							
		650	2455 .18 7.1	2163 .19 6.4	1807 .18 5.8	1362 .17 5.3	650 .13 5.3						
		700	2644 .23 8.1	2374 .23 7.4	2055 .23 6.8	1685 .23 6.2	1166 .20 6.1						
		750	2833 .28 9.1	2580 .29 8.4	2296 .29 7.8	1969 .28 7.3	1569 .26 6.9	999 .22 6.9					
		800	3022 .34 10.2	2784 .35 9.4	2528 .35 8.8	2232 .34 8.3	1898 .34 7.8	1455 .31 7.6	843 .24 7.6				
		825 *	3116 .37 10.6	2885 .38 10.0	2641 .38 9.3	2357 .38 8.8	2042 .37 8.3	1651 .35 8.0	1134 .30 8.0				
		875	3305 .44 11.7	3086 .45 11.1	2865 .46 10.4	2602 .45 9.9	2323 .45 9.4	2008 .44 8.9	1582 .40 8.8				
		925	3494 .53 13.0	3286 .53 12.3	3084 .54 11.7	2842 .54 11.1	2584 .53 10.5	2298 .52 10.1	1970 .50 9.7	988 .38 9.7			
		975	3683 .62 14.2	3486 .62 13.5	3296 .63 12.9	3075 .63 12.3	2832 .63 11.8	2579 .62 11.3	2296 .61 10.8	1517 .52 10.5			
		1025	3871 .72 15.4	3685 .72 14.8	3502 .73 14.3	3301 .73 13.7	3076 .73 13.3	2843 .72 12.7	2584 .71 12.2	1945 .65 11.6	979 .50 11.6		
	1075 *	4060 .82 16.7	3882 .83 16.1	3767 .84 15.7	3523 .85 15.2	3315 .85 14.7	3092 .84 14.2	2864 .83 13.7	2327 .79 12.7	1561 .68 12.7			
<b>ALL OTHER MOTORS</b>		1140 *	4306 .98 18.7	4138 .99 18.1	3972 1.00 17.6	3811 1.01 17.1	3615 1.01 16.7	3410 1.01 16.2	3200 1.00 15.6	2734 .97 14.7	2128 .90 14.2		

Performance certified is for installation type A - free inlet, free outlet. Speed (RPM) is nominal. Performance is based on actual speed of test.

**\*\* To be Speed Controllable, motor must have 115/1 ODP. Other voltages and enclosures are non-speed controllable.**

\* Base Unit - As run motor speeds.

+ RPM range capable with solid state speed control.

Performance ratings do not include the effects of accessories.

The sound power level ratings shown are in decibels, referred to 10<sup>-12</sup> watts calculated per AMCA Standard 301. Values shown are for inlet L<sub>W</sub> sound power levels for installation Type A free inlet, free outlet. Ratings do not include the effects of duct end correction.

The sound ratings shown are loudness values in fan sones at 5 feet (1.5m) in a hemispherical free field calculated per AMCA Standard 301. Values shown are for installation Type A, free inlet hemispherical sone levels.

**\*NOTE:** R3 motors are specifically designed to operate through the above performance range. The motor will not be damaged or harmed at the higher BHP values.

### VWDK 18 AIR PERFORMANCE

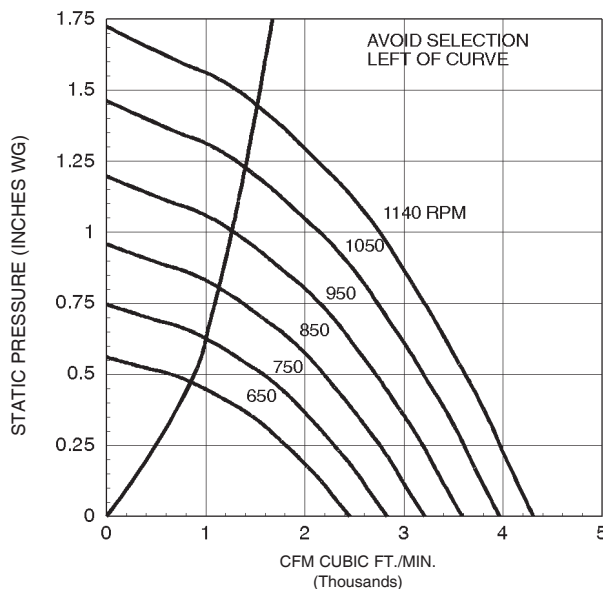

### VWDK 18 SOUND PERFORMANCE

RPM	SP	SOUND POWER RE 10 <sup>-12</sup> WATTS								
		OCTAVE BANDS								
		1	2	3	4	5	6	7	8	LWA
825	.000	75	77	71	68	68	65	60	54	73
	.125	74	77	70	67	67	64	58	53	71
	.250	74	76	69	66	65	62	57	51	70
	.500	72	74	67	64	63	60	56	52	68
	.750	71	73	66	62	62	60	56	52	67
1075	.000	83	83	81	75	74	72	67	62	80
	.250	82	83	80	74	73	70	66	60	78
	.500	81	82	79	72	71	69	64	59	77
	.750	80	81	78	71	69	68	64	59	76
	1.000	79	79	77	70	68	66	63	59	75

# VWBK 06

## BELT DRIVE

### PERFORMANCE DATA

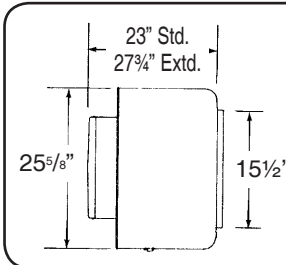

#### DESIGN DATA

$$\text{Max BHP} = .023 \times \left[ \frac{\text{RPM}}{1000} \right]^3$$

Tip Speed = 2.75 x RPM  
 Max. Motor Frame Size = 56  
 Unit Weight (less motor) = 45 lbs.  
 Wall Opening = 12" Sq.  
 Damper Size = 12" Sq.

RPM Range - Motor HP (1/6)	K1 RPM	STATIC PRESSURE, INCHES W. G.															
		.000	.125	.250	.375	.500	.625	.750	1.000	1.250	1.500	1.750	2.000				
		CFM SONES	BHP SONES	CFM SONES	BHP SONES	CFM SONES	BHP SONES	CFM SONES	BHP SONES	CFM SONES	BHP SONES	CFM SONES	BHP SONES	CFM SONES	BHP SONES	CFM SONES	BHP SONES
K2 (1/6)	600	225 .01 .5															
	700	263 .01 1.0	119 .01 1.3														
K3 (1/6)	800	300 .01 1.6	193 .01 1.7														
	900	338 .01 2.1	248 .02 2.1														
K4 (1/6)	1000	376 .02 2.8	297 .02 2.7	179 .02 3.5													
	1100	413 .02 3.5	343 .03 3.3	253 .03 3.7													
K5 (1/6)	1200	451 .03 4.1	387 .04 3.9	314 .04 4.0	194 .04 5.0												
	1300	488 .04 4.7	429 .04 4.6	365 .05 4.5	278 .05 5.3												
L1 (1/4)	1400	526 .05 5.4	471 .05 5.3	414 .06 5.2	343 .06 5.6	239 .06 6.5											
	1500	563 .06 6.1	513 .07 6.0	461 .07 5.9	400 .07 6.0	320 .08 6.8											
M1 (1/3)	1550	582 .07 6.5	533 .07 6.3	483 .08 6.2	426 .08 6.2	354 .08 7.0	252 .09 7.9										
	1600	601 .07 6.8	553 .08 6.7	505 .08 6.6	451 .09 6.5	385 .09 7.2	300 .09 8.0										
L1 (1/4)	1650	620 .08 7.2	574 .09 7.1	527 .09 7.0	475 .10 6.9	416 .10 7.4	338 .10 8.2	218 .10 9.2									
	1700	639 .09 7.6	594 .09 7.5	548 .10 7.4	500 .10 7.3	446 .11 7.6	375 .11 8.4	278 .11 9.3									
L1 (1/4)	1750	657 .10 8.0	614 .10 7.9	570 .11 7.8	524 .11 7.7	471 .12 7.8	407 .12 8.6	327 .12 9.5									
	1800	676 .10 8.4	634 .11 8.3	591 .12 8.1	548 .12 8.1	496 .13 8.0	438 .13 8.8	365 .13 9.7									
L1 (1/4)	1850	695 .11 8.8	654 .12 8.7	612 .13 8.6	570 .13 8.5	521 .14 8.4	468 .14 9.0	401 .14 9.9									
	1900	714 .12 9.2	674 .13 9.1	633 .14 9.0	592 .14 8.9	546 .15 8.8	498 .15 9.3	435 .15 10.1									
L1 (1/4)	1950	732 .13 9.6	693 .14 9.5	654 .15 9.4	614 .15 9.3	571 .16 9.2	523 .16 9.5	466 .17 10.3	308 .17 12.2								
	2000	751 .14 10.0	713 .15 9.9	675 .16 9.8	636 .16 9.8	595 .17 9.7	549 .18 10.5	497 .18 10.5	357 .18 12.4								
L1 (1/4)	2050	770 .15 10.5	733 .16 10.4	696 .17 10.3	658 .18 10.2	619 .18 10.1	574 .19 10.1	527 .19 10.8	400 .20 12.6								
	2100	789 .16 10.9	753 .17 10.9	716 .18 10.8	679 .19 10.7	642 .19 10.6	599 .20 10.5	555 .21 11.0	437 .21 12.8								
L1 (1/4)	2150	808 .18 11.4	772 .18 11.3	737 .19 11.2	701 .20 11.2	664 .21 11.1	623 .21 11.0	580 .22 11.3	474 .23 15.0	307 .23 15.0							
	2200	826 .19 12.0	792 .20 11.8	757 .21 11.7	722 .21 11.7	686 .22 11.6	648 .23 11.5	606 .23 11.5	506 .24 15.2	364 .24 15.2							
L1 (1/4)	2250	845 .20 12.4	811 .21 12.3	777 .22 12.2	743 .23 12.2	708 .23 12.1	672 .24 12.0	631 .25 11.9	537 .26 15.3	413 .26 15.3							
	2300	864 .22 12.8	831 .23 12.8	798 .23 12.7	764 .24 12.6	730 .25 12.6	696 .26 12.5	656 .26 12.4	568 .27 15.5	453 .28 15.5							
L1 (1/4)	2350	883 .23 13.3	850 .24 13.2	818 .25 13.1	785 .26 13.1	752 .26 13.0	719 .27 13.0	680 .28 12.9	598 .29 15.7	490 .30 17.7	330 .30 17.7						
	2400	901 .25 13.7	870 .25 13.6	838 .26 13.6	806 .27 13.5	774 .28 13.5	741 .29 13.4	704 .29 13.4	628 .31 14.1	527 .31 15.8	389 .32 17.8						
L1 (1/4)	2450	920 .26 14.1	889 .27 14.1	858 .28 14.0	827 .29 14.0	795 .30 13.9	763 .30 13.9	729 .31 14.4	654 .33 16.0	560 .33 17.9	438 .34 17.9						
	2500	939 .28 14.6	909 .29 14.5	878 .30 14.5	848 .31 14.5	816 .31 14.4	785 .32 14.4	753 .33 14.4	679 .34 16.2	591 .35 18.0	482 .36 18.0						

Performance certified is for installation type A - free inlet, free outlet.  
 Performance ratings (bhp) do not include transmission losses.  
 Performance ratings do not include the effects of accessories.

The sound ratings shown are loudness values in fan sones at 5 feet (1.5m) in a hemispherical free field calculated per AMCA Standard 301. Values shown are for installation type A, free inlet hemispherical sone levels.

# VWBK 08

## BELT DRIVE

### PERFORMANCE DATA

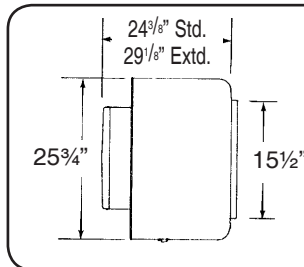

#### DESIGN DATA

$$\text{Max BHP} = .033 \times \left[ \frac{\text{RPM}}{1000} \right]^3$$

- Tip Speed = 2.75 x RPM
- Max. Motor Frame Size = 56
- Unit Weight (less motor) = 45 lbs.
- Wall Opening = 12" Sq.
- Damper Size = 12" Sq.

RPM Range - Motor HP		STATIC PRESSURE, INCHES W. G.												
K1 (1/6)	RPM	.000	.125	.250	.375	.500	.625	.750	1.000	1.250	1.500	1.750	2.000	
		CFM BHP SONES	CFM BHP SONES	CFM BHP SONES	CFM BHP SONES	CFM BHP SONES	CFM BHP SONES	CFM BHP SONES	CFM BHP SONES	CFM BHP SONES	CFM BHP SONES	CFM BHP SONES	CFM BHP SONES	CFM BHP SONES
K2 (1/6)	650	359 .01 2.0	154 .01 1.4											
	750	415 .01 2.8	267 .01 2.0											
K3 (1/6)	850	470 .02 3.7	347 .02 2.8											
	950	525 .02 4.6	421 .03 3.8	266 .03 3.8										
K4 (1/6)	1050	580 .03 5.4	488 .04 4.5	368 .04 3.9										
	1150	636 .04 6.2	552 .05 5.4	452 .05 4.8	305 .05 4.6									
L1 (1/4)	1250	691 .05 7.1	614 .06 6.3	527 .06 5.6	420 .06 5.4									
	1350	746 .07 7.9	676 .07 7.2	600 .08 6.6	505 .08 6.3	385 .08 6.1								
M1 (1/3)	1450	802 .08 8.8	736 .09 8.2	667 .09 7.6	584 .10 7.1	490 .10 7.0	340 .10 6.9							
	1500	829 .09 9.3	766 .10 8.6	700 .10 8.1	622 .11 7.6	533 .11 7.4	417 .11 7.3							
P1 (1/2)	1550	857 .10 9.7	795 .11 9.1	732 .11 8.6	660 .12 8.1	576 .12 7.9	474 .12 7.7	280 .12 7.8						
	1600	884 .11 10.2	825 .12 9.6	764 .12 9.0	696 .13 8.6	617 .13 8.3	527 .13 8.2	390 .13 8.1						
K1 (1/6)	1650	912 .12 10.7	854 .13 10.1	795 .13 9.6	733 .14 9.1	656 .14 8.8	573 .15 8.7	468 .15 8.6						
	1700	940 .13 11.2	884 .14 10.6	827 .14 10.1	768 .15 9.6	694 .16 9.3	616 .16 9.1	522 .16 9.0						
K2 (1/6)	1750	967 .14 11.7	913 .15 11.1	858 .16 10.6	801 .16 10.2	732 .17 9.7	658 .17 9.6	574 .18 9.5						
	1800	995 .15 12.3	942 .16 11.8	889 .17 11.2	833 .18 10.6	769 .18 10.2	699 .19 10.1	621 .19 10.0	352 .18 10.0					
K3 (1/6)	1850	1023 .17 13.0	971 .18 12.4	920 .18 11.9	865 .19 11.3	806 .20 10.8	737 .20 10.7	664 .20 10.6	455 .20 10.4					
	1900	1050 .18 13.7	1000 .19 13.1	950 .20 12.5	897 .21 12.0	842 .21 11.5	776 .22 11.2	706 .22 11.1	532 .23 11.0					
K4 (1/6)	1950	1078 .20 14.4	1029 .21 13.8	981 .21 13.2	929 .22 12.7	878 .23 12.2	813 .23 11.8	748 .24 11.7	589 .24 11.5					
	2000	1106 .21 15.1	1057 .22 14.5	1011 .23 14.0	961 .24 13.4	911 .25 12.9	851 .25 12.5	787 .25 12.4	641 .26 12.1	359 .26 12.1				
L1 (1/4)	2050	1133 .23 15.9	1086 .24 15.3	1041 .25 14.7	992 .25 14.2	944 .26 13.6	888 .27 13.1	826 .27 13.0	693 .28 12.8	480 .28 12.6				
	2100	1161 .25 16.6	1115 .25 16.0	1070 .26 15.5	1024 .27 14.9	976 .28 14.4	924 .29 13.9	864 .29 13.6	736 .30 13.4	558 .30 13.3				
M1 (1/3)	2150	1189 .26 17.4	1143 .27 16.8	1100 .28 16.2	1055 .29 15.7	1008 .30 15.2	960 .31 14.7	901 .31 14.3	779 .32 14.1	626 .33 13.9				
	2200	1216 .28 18.2	1172 .29 17.6	1130 .30 17.0	1086 .31 16.4	1040 .32 15.9	995 .33 15.5	939 .33 15.0	821 .34 14.7	679 .35 14.5	419 .33 14.4			
P1 (1/2)	2250	1244 .30 18.7	1201 .31 18.1	1159 .32 17.6	1116 .33 17.0	1072 .34 16.6	1028 .35 16.1	975 .35 15.6	862 .36 15.3	732 .37 15.1	532 .37 14.9			
	2300	1271 .32 19.2	1229 .33 18.7	1189 .34 18.2	1147 .35 17.6	1104 .36 17.2	1060 .37 16.7	1012 .38 16.3	903 .39 15.9	782 .40 15.7	610 .40 15.6			
K2 (1/6)	2350	1299 .34 19.8	1258 .35 19.3	1218 .36 18.7	1178 .37 18.2	1135 .38 17.8	1093 .39 17.3	1048 .40 16.9	940 .41 16.5	825 .42 16.3	680 .43 16.2			
	2400	1327 .37 20	1286 .38 19.8	1247 .39 19.3	1208 .40 18.9	1166 .41 18.4	1125 .42 18.0	1083 .43 17.6	979 .44 17.1	867 .45 16.9	733 .45 16.8	519 .44 16.7		
K3 (1/6)	2450	1354 .39 21	1314 .40 20	1276 .41 19.9	1238 .42 19.5	1198 .43 19.1	1157 .44 18.6	1116 .45 18.2	1016 .46 17.7	909 .47 17.5	786 .48 17.4	606 .48 17.3		
	2500	1382 .41 21	1343 .43 21	1305 .44 21	1268 .45 20	1229 .46 19.7	1189 .47 19.3	1149 .48 18.9	1054 .49 18.2	951 .50 18.1	839 .51 18.0	683 .51 17.9		

Performance certified is for installation type A - free inlet, free outlet.  
Performance ratings (bhp) do not include transmission losses.  
Performance ratings do not include the effects of accessories.

The sound ratings shown are loudness values in fan sones at 5 feet (1.5m) in a hemispherical free field calculated per AMCA Standard 301. Values shown are for installation type A, free inlet hemispherical sone levels.

# VWBK 10

## BELT DRIVE

### PERFORMANCE DATA

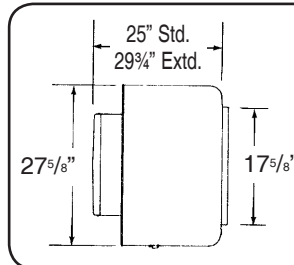

#### DESIGN DATA

$$\text{Max BHP} = .081 \times \left[ \frac{\text{RPM}}{1000} \right]^3$$

- Tip Speed = 3.27 x RPM
- Max. Motor Frame Size = 145T
- Unit Weight (less motor) = 50 lbs.
- Wall Opening = 14" Sq.
- Damper Size = 14" Sq.

RPM Range - Motor HP		STATIC PRESSURE, INCHES W. G.											
K1 (1/6)	RPM	.000	.250	.500	.750	1.000	1.250	1.500	1.750	2.000	2.250	2.500	2.750
		CFM BHP SONES	CFM BHP SONES	CFM BHP SONES	CFM BHP SONES	CFM BHP SONES	CFM BHP SONES	CFM BHP SONES	CFM BHP SONES	CFM BHP SONES	CFM BHP SONES	CFM BHP SONES	CFM BHP SONES
K2 (1/6)	650	616 .02 2.8											
	750	711 .03 3.8	331 .03 3.7										
L1 (1/4)	850	805 .04 4.8	515 .05 4.5										
	950	900 .06 5.7	657 .07 5.2										
M1 (1/3)	1050	995 .08 6.7	782 .09 6.1	439 .09 6.6									
	1150	1090 .10 7.8	897 .12 7.3	645 .12 7.5									
P1 (1/2)	1200	1136 .11 8.4	954 .13 7.8	725 .14 8.0									
	1250	1184 .13 9.0	1009 .15 8.4	800 .16 8.6	416 .15 8.9								
R1 (3/4)	1300	1230 .14 9.6	1064 .16 9.0	875 .18 9.1	576 .17 9.4								
	1350	1279 .16 10.3	1118 .18 9.7	937 .20 9.7	684 .20 10.0								
S1 (1)	1400	1327 .18 10.9	1172 .20 10.3	1001 .22 10.3	775 .22 10.6								
	1450	1374 .20 11.7	1226 .22 11.0	1063 .24 10.9	858 .25 11.2	508 .23 11.5							
T1 (1-1/2)	1500	1421 .22 12.4	1279 .24 11.7	1124 .26 11.6	933 .27 11.9	662 .26 12.1							
	1550	1469 .24 13.1	1331 .27 12.4	1182 .29 12.3	1007 .30 12.5	773 .30 12.8							
	1600	1516 .27 13.9	1383 .29 13.1	1239 .31 13.1	1080 .33 13.2	865 .33 13.4	480 .30 13.7						
	1650	1563 .29 14.6	1435 .32 13.9	1296 .34 13.8	1144 .36 13.8	954 .36 14.1	667 .35 14.3						
	1700	1611 .32 15.2	1486 .35 14.5	1352 .37 14.3	1207 .39 14.4	1030 .40 14.6	801 .39 14.8						
	1750	1658 .35 15.8	1536 .38 15.1	1407 .40 14.9	1270 .42 14.9	1105 .43 15.1	896 .43 15.4	514 .40 15.6					
	1800	1706 .38 16.5	1587 .41 15.8	1462 .43 15.5	1332 .45 15.4	1178 .47 15.7	987 .47 15.9	710 .45 16.1					
	1850	1753 .42 17.2	1637 .44 16.4	1517 .47 16.1	1393 .49 16.0	1250 .51 16.2	1075 .51 16.5	845 .50 16.7					
	1900	1800 .45 17.8	1688 .48 17.1	1571 .50 16.7	1450 .53 16.6	1314 .55 16.8	1151 .55 17.0	950 .55 17.3	596 .51 17.5				
	1950	1848 .49 18.6	1738 .52 17.8	1625 .54 17.4	1507 .57 17.3	1378 .59 17.4	1225 .60 17.6	1042 .60 17.9	783 .58 18.1				
	2000	1895 .53 19.4	1788 .56 18.6	1679 .58 18.0	1564 .61 18.0	1440 .63 18.0	1299 .64 18.3	1132 .65 18.5	918 .63 18.8	446 .55 19.1			
	2050	1942 .57 20.2	1838 .60 19.4	1733 .63 18.9	1620 .65 18.8	1502 .67 18.8	1374 .69 19.0	1213 .70 19.3	1022 .69 19.5	716 .66 19.8			
	2100	1990 .61 21.0	1887 .64 20.3	1786 .67 19.7	1676 .70 19.6	1564 .72 19.6	1438 .74 19.8	1288 .75 20.0	1114 .74 20.3	878 .73 20.5			
	2150	2037 .65 21.9	1937 .69 21.1	1839 .72 20.5	1731 .74 20.4	1625 .77 20.4	1502 .79 20.5	1363 .80 20.8	1204 .80 21.0	1013 .78 21.2	658 .74 21.4		
	2200	2085 .70 21.8	1987 .73 22.0	1891 .77 21.3	1786 .79 21.2	1681 .82 21.2	1565 .84 21.3	1436 .86 21.5	1289 .86 21.7	1108 .86 22.0	857 .83 22.2		
	2250	2132 .75 23.7	2036 .78 22.9	1943 .82 22.2	1841 .84 22.1	1738 .87 22.1	1628 .89 22.1	1510 .92 22.3	1364 .92 22.5	1200 .92 22.8	993 .89 23.0	601 .84 23.2	
	2350	2227 .85 25.4	2135 .89 24.7	2046 .92 24.1	1950 .95 23.9	1851 .98 23.8	1751 .101 23.8	1639 .103 23.9	1513 .105 24.1	1375 .105 24.3	1206 .105 24.5	988 .102 24.7	563 .93 25.0
	2450	2321 .97 27.3	2233 .100 26.6	2148 .104 25.9	2057 .207 25.7	1963 .110 25.6	1868 .113 25.5	1765 .116 25.6	1657 .118 25.8	1525 .119 26.0	1387 .119 26.2	1221 .118 26.4	996 .115 26.6

Performance certified is for installation type A - free inlet, free outlet.  
 Performance ratings (bhp) do not include transmission losses.  
 Performance ratings do not include the effects of accessories.

The sound ratings shown are loudness values in fan sones at 5 feet (1.5m) in a hemispherical free field calculated per AMCA Standard 301. Values shown are for installation type A, free inlet hemispherical sone levels.



# VWBK 12

## BELT DRIVE

### PERFORMANCE DATA

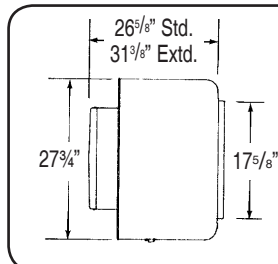

#### DESIGN DATA

$$\text{Max BHP} = .094 \times \left[ \frac{\text{RPM}}{1000} \right]^3$$

Tip Speed = 3.27 x RPM  
 Max. Motor Frame Size = 145T  
 Unit Weight (less motor) = 50 lbs.  
 Wall Opening = 14" Sq.  
 Damper Size = 14" Sq.

RPM Range - Motor HP		STATIC PRESSURE, INCHES W. G.											
K1 (1/6)	RPM	.000	.250	.500	.750	1.000	1.250	1.500	1.750	2.000	2.250	2.500	2.750
		CFM BHP SONES	CFM BHP SONES	CFM BHP SONES	CFM BHP SONES	CFM BHP SONES	CFM BHP SONES	CFM BHP SONES	CFM BHP SONES	CFM BHP SONES	CFM BHP SONES	CFM BHP SONES	CFM BHP SONES
K2 (1/6)	550	685 .02 2.0											
	650	810 .03 3.1											
K3 (1/6)	750	934 .04 4.3	515 .05 3.8										
	850	1059 .06 5.5	739 .07 4.7										
L1 (1/4)	950	1184 .08 6.6	910 .09 5.8										
	1050	1308 .11 7.9	1070 .12 7.1	695 .12 6.9									
M1 (1/3)	1100	1370 .13 8.6	1145 .14 7.7	839 .15 7.5									
	1150	1433 .14 9.3	1220 .16 8.4	942 .17 8.2									
P1 (1/2)	1200	1495 .16 10.0	1294 .18 9.2	1042 .19 8.8									
	1250	1557 .19 10.8	1367 .20 9.9	1128 .21 9.5	724 .20 9.5								
R1 (3/4)	1300	1620 .21 11.6	1439 .22 10.8	1214 .24 10.3	894 .24 10.3								
	1350	1682 .23 12.4	1511 .25 11.6	1297 .27 11.0	1033 .27 11.1								
S1 (1)	1450	1806 .29 14.1	1647 .31 13.5	1459 .33 12.9	1238 .34 12.9	864 .32 13.0							
	1500	1869 .32 15.1	1715 .34 14.4	1536 .36 13.9	1329 .37 13.7	1029 .36 13.9							
S1 (1)	1550	1931 .35 16.0	1782 .37 15.5	1611 .39 14.9	1415 .41 14.6	1175 .41 14.8							
	1600	1993 .39 17.0	1849 .41 16.4	1686 .43 15.8	1500 .45 15.4	1278 .45 15.6	874 .42 15.8						
S1 (1)	1650	2056 .43 17.6	1916 .45 17.1	1761 .47 16.4	1583 .49 16.1	1380 .50 16.2	1068 .48 16.2						
	1700	2118 .47 18.3	1982 .49 17.8	1834 .51 17.0	1666 .53 16.7	1478 .54 16.6	1220 .54 16.8						
S1 (1)	1750	2180 .51 19.1	2048 .53 18.5	1907 .55 17.9	1747 .58 17.5	1565 .59 17.3	1349 .59 17.5	946 .54 17.6					
	1800	2243 .56 19.9	2114 .58 19.3	1980 .60 18.9	1824 .62 18.5	1651 .64 18.2	1452 .64 18.2	1147 .62 18.2					
S1 (1)	1900	2367 .65 22	2246 .68 21	2123 .70 21	1976 .72 20	1819 .74 20	1652 .76 19.9	1442 .76 19.9	1065 .70 19.8				
	1950	2429 .71 23	2311 .73 22	2193 .75 22	2051 .78 21	1902 .80 21	1739 .82 21	1546 .82 21	1257 .79 21				
S1 (1)	2000	2492 .76 24	2376 .79 23	2261 .81 23	2125 .84 22	1984 .86 22	1825 .88 22	1648 .89 22	1409 .87 22	1001 .79 22			
	2050	2554 .82 25	2442 .85 24	2329 .87 24	2199 .90 23	2063 .92 23	1910 .94 23	1749 .96 23	1553 .95 23	1220 .90 23			
S1 (1)	2100	2616 .88 26	2506 .91 25	2397 .93 25	2273 .96 24	2140 .99 24	1994 1.01 24	1842 1.02 24	1657 1.02 24	1391 .99 24	938 .88 24		
	2200	2741 1.01 28	2636 1.04 27	2531 1.07 27	2418 1.09 26	2291 1.12 26	2159 1.15 26	2014 1.17 26	1860 1.18 26	1678 1.17 26	1391 1.13 26		
S1 (1)	2250	2803 1.09 29	2701 1.11 28	2598 1.14 28	2490 1.17 27	2366 1.19 27	2241 1.22 27	2099 1.24 27	1958 1.26 27	1782 1.26 27	1544 1.23 27	1181 1.14 27	433 .85 27

Performance certified is for installation type A - free inlet, free outlet.  
 Performance ratings (bhp) do not include transmission losses.  
 Performance ratings do not include the effects of accessories.

The sound ratings shown are loudness values in fan sones at 5 feet (1.5m) in a hemispherical free field calculated per AMCA Standard 301. Values shown are for installation type A, free inlet hemispherical sone levels.

Cent. Power Wall Vents

# VWBK 15

## BELT DRIVE

### PERFORMANCE DATA

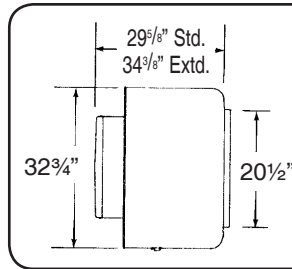

#### DESIGN DATA

Max BHP = .285 x  $\left[ \frac{\text{RPM}}{1000} \right]^3$

Tip Speed = 4.06 x RPM

Max. Motor Frame Size = 145T

Unit Weight (less motor) = 75 lbs.

Wall Opening = 17" Sq.

Damper Size = 17" Sq.

RPM Range - Motor HP		STATIC PRESSURE, INCHES W. G.												
K1 (1/6)	RPM	.000	.250	.500	.750	1.000	1.250	1.500	1.750	2.000	2.250	2.500	2.750	
		CFM SONES	BHP SONES	CFM SONES	BHP SONES	CFM SONES	BHP SONES	CFM SONES	BHP SONES	CFM SONES	BHP SONES	CFM SONES	BHP SONES	CFM SONES
K2 (1/6)	550	1214 .04	441 .04											
	600	1324 .06	796 .07											
L1 (1/4)	650	1434 .07	973 .08											
	700	1545 .09	1132 .10											
M1 (1/3)	750	1655 .11	1279 .13											
	800	1765 .14	1422 .15	854 .15										
P1 (1/2)	850	1876 .16	1557 .18	1131 .19										
	900	1986 .19	1689 .21	1309 .22										
R1 (3/4)	950	2096 .23	1819 .25	1480 .26	713 .22									
	1000	2207 .27	1948 .29	1630 .30	1170 .30									
S1 (1)	1050	2317 .31	2074 .33	1778 .35	1418 .35									
	1100	2427 .35	2195 .38	1922 .40	1595 .41	882 .35								
T1 (1-1/2)	1150	2538 .40	2316 .43	2062 .45	1770 .47	1324 .45								
	1200	2648 .46	2436 .49	2196 .51	1923 .53	1593 .53								
	1250	2758 .52	2555 .55	2329 .57	2072 .59	1771 .60	1215 .54							
	1300	2868 .58	2673 .61	2460 .64	2218 .66	1946 .67	1560 .66							
	1350	2979 .65	2791 .68	2590 .71	2362 .73	2112 .75	1811 .75	1133 .65						
	1400	3089 .73	2908 .76	2718 .79	2503 .82	2263 .83	1989 .84	1575 .81						
	1450	3199 .81	3024 .84	2846 .87	2637 .90	2412 .92	2164 .93	1851 .93	1067 .76					
	1500	3310 .90	3141 .93	2970 .96	2771 .99	2558 1.01	2333 1.03	2058 1.03	1627 .97					
	1525	3365 .94	3199 .98	3031 1.01	2837 1.04	2630 1.06	2409 1.08	2148 1.09	1773 1.05	633 .73				
	1550	3420 .99	3257 1.02	3091 1.06	2903 1.09	2702 1.11	2485 1.13	2236 1.14	1911 1.13	1138 .93				
	1575	3475 1.04	3314 1.07	3152 1.11	2968 1.14	2773 1.17	2559 1.18	2324 1.20	2048 1.19	1481 1.07				
	1600	3530 1.09	3372 1.12	3212 1.16	3033 1.19	2845 1.22	2634 1.24	2411 1.25	2152 1.26	1707 1.18				
	1625	3586 1.14	3430 1.18	3272 1.21	3098 1.25	2913 1.27	2708 1.29	2499 1.31	2241 1.31	1865 1.27	826 .94			
	1650	3641 1.19	3487 1.23	3332 1.27	3163 1.30	2980 1.33	2781 1.35	2577 1.37	2330 1.38	2004 1.35	1322 1.16			
	1675	3696 1.25	3545 1.29	3392 1.32	3227 1.36	3047 1.39	2854 1.41	2653 1.43	2418 1.44	2141 1.43	1612 1.30			
	1700	3751 1.31	3602 1.34	3452 1.38	3292 1.42	3114 1.45	2926 1.47	2728 1.49	2506 1.50	2263 1.51	1837 1.42			
	1725	3806 1.36	3660 1.40	3511 1.44	3356 1.48	3181 1.51	2998 1.54	2803 1.56	2593 1.57	2352 1.57	1986 1.52	1118 1.22		
	1750	3861 1.43	3717 1.46	3571 1.50	3419 1.54	3247 1.57	3070 1.60	2877 1.62	2681 1.64	2441 1.64	2125 1.61	1557 1.45		

Performance certified is for installation type A - free inlet, free outlet.  
 Performance ratings (bhp) do not include transmission losses.  
 Performance ratings do not include the effects of accessories.

The sound ratings shown are loudness values in fan sones at 5 feet (1.5m) in a hemispherical free field calculated per AMCA Standard 301. Values shown are for installation type A, free inlet hemispherical sone levels.

# VWBK 18

## BELT DRIVE

### PERFORMANCE DATA

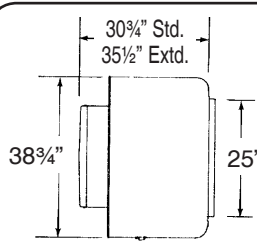

### DESIGN DATA

$$\text{Max BHP} = .659 \times \left[ \frac{\text{RPM}}{1000} \right]^3$$

- Tip Speed = 4.94 x RPM
- Max. Motor Frame Size = 145T
- Unit Weight (less motor) = 85 lbs.
- Wall Opening = 22" Sq.
- Damper Size = 22" Sq.

RPM Range - Motor HP	RPM	STATIC PRESSURE, INCHES W. G.											
		.000	.250	.500	.750	1.000	1.250	1.500	1.750	2.000	2.250	2.500	2.750
K1 (1/6)		CFM BHP SONES	CFM BHP SONES	CFM BHP SONES	CFM BHP SONES	CFM BHP SONES	CFM BHP SONES	CFM BHP SONES	CFM BHP SONES	CFM BHP SONES	CFM BHP SONES	CFM BHP SONES	CFM BHP SONES
L1 (1/4)	550	2045 .10 5.5	1364 .11 3.7										
	M1 (1/3)	600	2231 .13 6.4	1642 .14 4.7									
P1 (1/2)		650	2417 .17 7.3	1891 .18 5.8	820 .14 4.8								
	R1 (3/4)	700	2603 .21 8.3	2126 .23 6.8	1383 .21 5.5								
S1 (1)		750	2789 .26 9.3	2349 .28 7.9	1754 .27 6.6								
	T1 (1-1/2)	800	2974 .32 10.4	2569 .33 9.0	2067 .33 7.7	1089 .27 7.0							
V1 (2)		850	3160 .38 11.6	2785 .40 10.3	2330 .40 9.0	1635 .38 7.8							
	T1 (1-1/2)	900	3346 .45 12.4	2997 .47 11.1	2579 .48 10.1	2025 .47 9.2							
V1 (2)		950	3532 .53 13.6	3208 .56 12.4	2823 .56 11.3	2347 .56 10.3	1581 .49 10.2						
	T1 (1-1/2)	1000	3718 .62 14.8	3413 .65 13.7	3051 .66 12.6	2644 .66 11.6	2035 .62 11.1						
V1 (2)		1025	3811 .67 15.4	3513 .70 14.3	3164 .71 13.3	2772 .71 12.2	2229 .68 11.6	1236 .54 11.6					
	T1 (1-1/2)	1050	3904 .72 16.1	3613 .75 15.0	3275 .76 14.0	2899 .76 13.0	2412 .74 12.1	1640 .64 12.1					
V1 (2)		1075	3997 .78 16.7	3713 .80 15.7	3386 .81 14.7	3024 .82 13.7	2571 .80 12.7	1901 .73 12.7					
	T1 (1-1/2)	1100	4090 .83 17.5	3812 .86 16.4	3496 .87 15.5	3148 .88 14.5	2728 .86 13.5	2132 .82 13.3					
V1 (2)		1125	4183 .89 18.2	3911 .92 17.2	3605 .93 16.2	3271 .94 15.2	2884 .93 14.3	2329 .89 13.9	1402 .72 13.9				
	T1 (1-1/2)	1150	4276 .95 19.0	4010 .98 18.0	3714 .99 17.0	3392 1.00 16.0	3029 1.00 15.0	2523 .97 14.5	1795 .84 14.5				
V1 (2)		1175	4369 1.01 19.7	4108 1.04 18.7	3822 1.06 17.8	3513 1.07 16.8	3158 1.06 15.8	2703 1.04 15.0	2055 .95 15.0				
	T1 (1-1/2)	1200	4462 1.08 20	4207 1.11 19.5	3929 1.13 18.6	3625 1.14 17.6	3285 1.13 16.6	2863 1.11 15.7	2296 1.06 15.6	1030 .77 15.6			
V1 (2)		1225	4555 1.15 21	4305 1.18 20	4036 1.20 19.3	3738 1.21 18.4	3410 1.21 17.4	3020 1.19 16.5	2494 1.15 16.3	1727 .99 16.3			
	T1 (1-1/2)	1250	4648 1.22 22	4402 1.25 21	4142 1.27 20	3851 1.28 19.2	3535 1.28 18.3	3176 1.27 17.3	2689 1.24 16.9	2021 1.10 16.9			
V1 (2)		1275	4740 1.29 23	4500 1.32 22	4248 1.35 21	3962 1.36 20	3659 1.36 19.1	3330 1.35 18.2	2883 1.33 17.6	2280 1.22 17.6			
	T1 (1-1/2)	1300	4833 1.37 24	4598 1.40 23	4354 1.43 22	4073 1.44 21	3781 1.45 19.9	3460 1.44 19.0	3043 1.41 18.2	2510 1.35 18.2	1639 1.12 18.2		
V1 (2)		1325	4926 1.45 24	4695 1.48 24	4459 1.51 23	4184 1.52 22	3903 1.53 21	3588 1.53 19.8	3202 1.50 18.9	2708 1.45 18.8	2042 1.31 18.8		
	T1 (1-1/2)	1350	5019 1.54 25	4792 1.57 24	4564 1.60 23	4294 1.61 23	4024 1.62 22	3714 1.62 21	3359 1.60 19.8	2903 1.56 19.5	2303 1.42 19.5		
V1 (2)		1375	5112 1.62 26	4889 1.66 25	4668 1.69 24	4403 1.70 23	4138 1.71 23	3840 1.71 22	3514 1.69 21	3096 1.67 20	2560 1.56 20	1655 1.29 20	
	T1 (1-1/2)	1400	5205 1.71 27	4986 1.75 26	4769 1.78 25	4511 1.79 24	4251 1.81 23	3965 1.80 22	3666 1.80 22	3261 1.77 21	2765 1.70 21	2109 1.53 21	
V1 (2)		1425	5298 1.81 28	5083 1.84 27	4870 1.87 26	4620 1.89 25	4364 1.90 24	4088 1.90 23	3795 1.90 22	3420 1.86 22	2962 1.81 22	2371 1.65 22	
	T1 (1-1/2)	1450	5391 1.90 29	5179 1.94 28	4970 1.97 27	4727 1.99 26	4476 2.00 25	4211 2.01 24	3923 2.00 23	3577 1.97 22	3156 1.93 22	2629 1.81 22	1758 1.52 22
V1 (2)		1475	5484 2.00 30	5276 2.04 29	5070 2.07 28	4835 2.09 27	4588 2.11 26	4333 2.11 25	4050 2.11 24	3733 2.09 23	3346 2.06 23	2854 1.97 23	2215 1.79 23
	T1 (1-1/2)	1500	5577 2.11 31	5372 2.14 30	5170 2.18 29	4942 2.20 28	4699 2.21 27	4454 2.22 26	4175 2.22 25	3887 2.20 24	3507 2.16 24	3052 2.10 24	2478 1.92 24

Performance certified is for installation type A - free inlet, free outlet.  
 Performance ratings (bhp) do not include transmission losses.  
 Performance ratings do not include the effects of accessories.

The sound ratings shown are loudness values in fan sones at 5 feet (1.5m) in a hemispherical free field calculated per AMCA Standard 301. Values shown are for installation type A, free inlet hemispherical sone levels.

# VWBK 21

## BELT DRIVE

### PERFORMANCE DATA

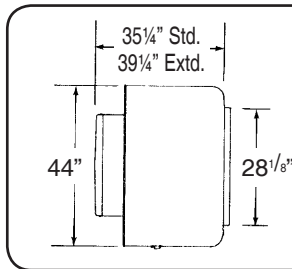

#### DESIGN DATA

$$\text{Max BHP} = 1.27 \times \left[ \frac{\text{RPM}}{1000} \right]^3$$

- Tip Speed = 5.76 x RPM
- Max. Motor Frame Size = 184T
- Unit Weight (less motor) = 130 lbs.
- Wall Opening = 25" Sq.
- Damper Size = 25" Sq.

RPM Range - Motor HP		STATIC PRESSURE, INCHES W. G.												
L1 (1/4)	RPM	.000	.250	.500	.750	1.000	1.250	1.500	1.750	2.000	2.250	2.500	2.750	
		CFM SONES	BHP SONES	CFM SONES	BHP SONES	CFM SONES	BHP SONES	CFM SONES	BHP SONES	CFM SONES	BHP SONES	CFM SONES	BHP SONES	CFM SONES
M1 (1/3)	400	2168 .08 4.2	728 .06 3.3											
	450	2439 .11 5.3	1443 .11 4.2											
	500	2709 .15 6.4	1883 .15 5.3											
P1 (1/2)	550	2980 .20 7.6	2261 .21 6.4	329 .10 6.1										
	600	3251 .26 8.8	2614 .27 7.4	1608 .25 7.1										
	650	3522 .34 10.0	2941 .35 8.6	2163 .34 8.2										
R1 (3/4)	700	3793 .42 11.2	3261 .43 9.9	2602 .42 9.4	1401 .35 9.3									
	750	4064 .52 12.6	3575 .53 11.3	2992 .53 10.7	2162 .50 10.5									
	800	4335 .63 14.0	3884 .65 12.8	3360 .65 12.0	2685 .63 11.8	1456 .50 11.7								
S1 (1)	850	4606 .75 15.6	4189 .77 14.4	3707 .78 13.4	3124 .75 13.2	2297 .71 13.1								
	875	4742 .82 16.4	4339 .84 15.2	3872 .85 14.1	3336 .84 13.9	2603 .80 13.8	812 .48 13.7							
	900	4877 .89 17.2	4485 .92 16.0	4035 .93 14.9	3525 .92 14.7	2886 .89 14.5	1737 .73 14.4							
T1 (1-1/2)	925	5012 .97 18.1	4631 .99 16.9	4197 1.00 15.7	3713 1.00 15.4	3111 .97 15.2	2162 .87 15.1							
	950	5148 1.05 18.9	4777 1.08 17.7	4358 1.09 16.6	3897 1.09 16.1	3333 1.06 15.9	2563 .99 15.8							
	975	5283 1.13 19.8	4921 1.16 18.6	4517 1.17 17.5	4080 1.18 16.9	3551 1.13 16.7	2871 1.11 16.6	1690 .87 16.6						
V1 (2)	1000	5419 1.22 21	5066 1.25 19.5	4676 1.27 18.4	4261 1.27 17.7	3766 1.24 17.6	3164 1.21 17.4	2152 1.15 17.4						
	1050	5690 1.41 22	5353 1.44 21	4989 1.46 20	4599 1.47 19.4	4152 1.46 19.2	3619 1.43 19.1	2930 1.36 19.0	1764 1.07 19.0					
	1075	5825 1.52 23	5497 1.55 22	5145 1.57 21	4764 1.58 20	4338 1.57 20	3839 1.51 20	3227 1.49 19.9	2240 1.42 19.8					
W1 (3)	1100	5961 1.62 24	5639 1.66 23	5300 1.68 22	4927 1.69 21	4523 1.69 21	4056 1.63 21	3513 1.62 21	2648 1.48 21	657 .78 21				
	1125	6096 1.74 25	5782 1.77 24	5454 1.80 23	5089 1.81 22	4705 1.81 22	4270 1.76 22	3740 1.74 22	3047 1.65 22	1935 1.33 22				
	1150	6232 1.86 26	5924 1.89 25	5607 1.92 24	5251 1.93 23	4886 1.93 23	4461 1.92 23	3963 1.88 23	3354 1.82 22	2408 1.73 22				
	1175	6367 1.98 27	6066 2.02 26	5759 2.05 25	5411 2.06 24	5062 2.06 23	4650 2.05 23	4183 1.97 23	3648 1.95 23	2815 1.80 23	1146 1.18 23			
	1200	6503 2.11 28	6208 2.15 27	5911 2.18 26	5570 2.19 25	5228 2.20 24	4836 2.19 24	4400 2.12 24	3903 2.11 24	3215 1.99 24	2184 1.68 24			
	1225	6638 2.24 29	6349 2.28 28	6063 2.32 27	5728 2.33 26	5394 2.34 25	5021 2.33 25	4615 2.27 25	4128 2.26 25	3533 2.19 25	2640 2.11 25			
	1250	6774 2.38 30	6490 2.42 29	6210 2.46 27	5886 2.47 27	5558 2.48 26	5204 2.48 26	4813 2.46 26	4350 2.41 26	3828 2.36 26	3046 2.18 26	2009 1.82 26		
	1275	6909 2.53 30	6631 2.57 29	6356 2.61 28	6042 2.62 28	5721 2.63 27	5385 2.63 27	5002 2.62 27	4569 2.52 27	4101 2.52 27	3445 2.39 27	2499 2.10 27		
	1300	7045 2.68 31	6772 2.72 30	6502 2.76 29	6198 2.78 28	5883 2.79 28	5566 2.80 27	5190 2.78 27	4786 2.70 27	4327 2.69 27	3756 2.62 27	2926 2.53 27	1320 1.63 27	
	1325	7180 2.84 32	6912 2.88 31	6648 2.92 30	6353 2.94 29	6044 2.95 29	5735 2.96 28	5375 2.95 28	5001 2.88 28	4550 2.87 28	4051 2.81 28	3330 2.62 28	2383 2.24 28	
	1350	7316 3.00 33	7053 3.04 32	6793 3.08 31	6508 3.11 30	6204 3.12 30	5901 3.13 29	5560 3.12 29	5198 3.10 29	4771 3.05 29	4328 2.99 29	3716 2.89 29	2848 2.81 29	
	1375	7451 3.17 34	7193 3.22 33	6938 3.26 32	6662 3.28 31	6364 3.29 31	6066 3.30 30	5742 3.30 30	5387 3.28 30	4989 3.18 30	4555 3.18 30	4015 3.10 30	3256 2.88 30	

Performance certified is for installation type A - free inlet, free outlet.  
Performance ratings (bhp) do not include transmission losses.  
Performance ratings do not include the effects of accessories.

The sound ratings shown are loudness values in fan sones at 5 feet (1.5m) in a hemispherical free field calculated per AMCA Standard 301. Values shown are for installation type A, free inlet hemispherical sone levels.

# VWBK 24

## BELT DRIVE

### PERFORMANCE DATA

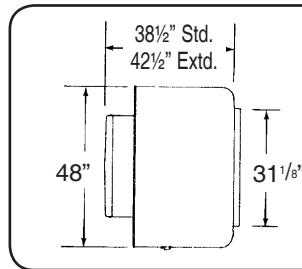

#### DESIGN DATA

$$\text{Max BHP} = 3.28 \times \left[ \frac{\text{RPM}}{1000} \right]^3$$

- Tip Speed = 6.68 x RPM
- Max. Motor Frame Size = 184T
- Unit Weight (less motor) = 160 lbs.
- Wall Opening = 28" Sq.
- Damper Size = 28" Sq.

RPM Range - Motor HP		STATIC PRESSURE, INCHES W. G.											
M1 (1/3)	RPM	.000	.250	.500	.750	1.000	1.250	1.500	1.750	2.000	2.250	2.500	2.750
		CFM BHP	CFM BHP	CFM BHP	CFM BHP	CFM BHP	CFM BHP	CFM BHP	CFM BHP	CFM BHP	CFM BHP	CFM BHP	CFM BHP
		SONES	SONES	SONES	SONES	SONES	SONES	SONES	SONES	SONES	SONES	SONES	SONES
P1 (1/2)	400	3618 .21 6.5	2241 .19 5.0										
	425	3845 .25 7.3	2595 .24 5.7										
	450	4070 .29 8.2	2927 .29 6.5										
	475	4298 .34 8.9	3247 .34 7.1										
R1 (3/4) S1 (1)	500	4523 .40 9.7	3559 .40 7.8	1907 .33 7.3									
	525	4750 .47 10.4	3848 .47 8.6	2484 .42 7.9									
	550	4975 .54 11.2	4125 .54 9.4	2942 .50 8.7									
	575	5201 .61 12.0	4398 .62 10.3	3303 .58 9.5									
T1 (1-1/2)	600	5427 .70 12.9	4667 .70 11.2	3655 .67 10.3	1941 .53 9.9								
	625	5653 .79 13.8	4934 .80 12.2	3991 .77 11.2	2664 .67 10.7								
	650	5879 .88 14.6	5197 .90 13.2	4315 .87 12.1	3173 .78 11.5								
	675	6105 .99 15.5	5458 1.01 14.1	4633 .98 13.0	3623 .92 12.4	1346 .59 12.2							
V1 (2)	700	6332 1.10 16.5	5711 1.12 15.1	4945 1.10 13.9	3985 1.04 13.4	2504 .88 13.0							
	725	6558 1.23 17.7	5959 1.25 16.1	5247 1.24 14.9	4339 1.18 14.4	3162 1.06 13.9							
	750	6784 1.36 18.8	6205 1.38 17.2	5526 1.38 16.0	4686 1.32 15.4	3654 1.20 14.9							
	775	7010 1.50 19.9	6450 1.52 18.3	5803 1.52 17.1	5013 1.47 16.4	4111 1.37 15.7	2520 1.14 15.7						
W1 (3)	800	7236 1.65 21	6693 1.67 19.5	6077 1.68 18.2	5335 1.63 17.5	4482 1.55 17.1	3261 1.39 16.8						
	825	7462 1.81 22	6936 1.83 21	6348 1.83 19.4	5653 1.80 18.6	4839 1.73 18.3	3833 1.61 17.9	1535 1.04 17.9					
	850	7688 1.98 23	7178 2.00 22	6616 2.00 21	5966 1.97 19.7	5189 1.91 19.4	4296 1.77 19.0	2799 1.52 18.9					
	875	7914 2.16 25	7418 2.18 23	6883 2.19 22	6275 2.16 21	5528 2.10 20	4730 2.00 20	3537 1.81 18.1					
900	8141 2.35 26	7658 2.37 24	7148 2.38 23	6561 2.37 22	5854 2.31 22	5092 2.22 21	4129 2.08 21	2244 1.56 21					
	8324 2.51 27	7850 2.53 25	7358 2.55 24	6784 2.54 23	6112 2.47 22	5377 2.39 22	4501 2.22 22	3092 1.95 22					
	8505 2.67 28	8041 2.70 26	7567 2.72 25	7006 2.71 24	6367 2.65 23	5658 2.57 23	4868 2.42 23	3687 2.21 23					
	8686 2.85 29	8231 2.88 27	7776 2.90 26	7226 2.90 25	6620 2.83 24	5936 2.76 24	5203 2.65 23	4206 2.48 23	2258 1.84 23				
950	8776 2.94 29	8326 2.97 27	7879 2.99 26	7335 2.99 25	6745 2.93 24	6074 2.86 24	5348 2.75 24	4420 2.60 24	2807 2.12 24				
	8867 3.03 29	8421 3.06 28	7978 3.09 27	7444 3.08 26	6870 3.02 25	6203 2.96 25	5493 2.85 24	4607 2.71 24	3177 2.31 24				
	8957 3.12 30	8516 3.15 28	8078 3.18 27	7553 3.18 26	6995 3.12 25	6334 3.06 25	5636 2.96 25	4793 2.81 24	3543 2.49 24				
	9045 3.22 30	8611 3.25 29	8177 3.28 28	7662 3.28 27	7118 3.22 26	6464 3.16 25	5779 3.06 25	4978 2.87 25	3813 2.62 25				

Performance certified is for installation type A - free inlet, free outlet.  
Performance ratings (bhp) do not include transmission losses.  
Performance ratings do not include the effects of accessories.

The sound ratings shown are loudness values in fan sones at 5 feet (1.5m) in a hemispherical free field calculated per AMCA Standard 301. Values shown are for installation type A, free inlet hemispherical sone levels.



**VWBK 06**  
**AIR PERFORMANCE**

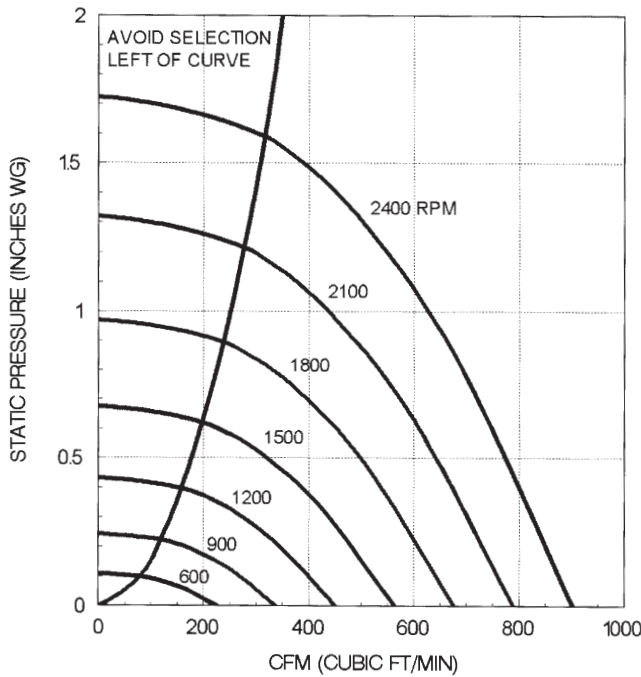

Performance certified is for installation type A - free inlet, free outlet.  
Performance ratings (bhp) do not include transmission losses.  
Performance ratings do not include the effects of accessories.

**VWBK 08**  
**AIR PERFORMANCE**

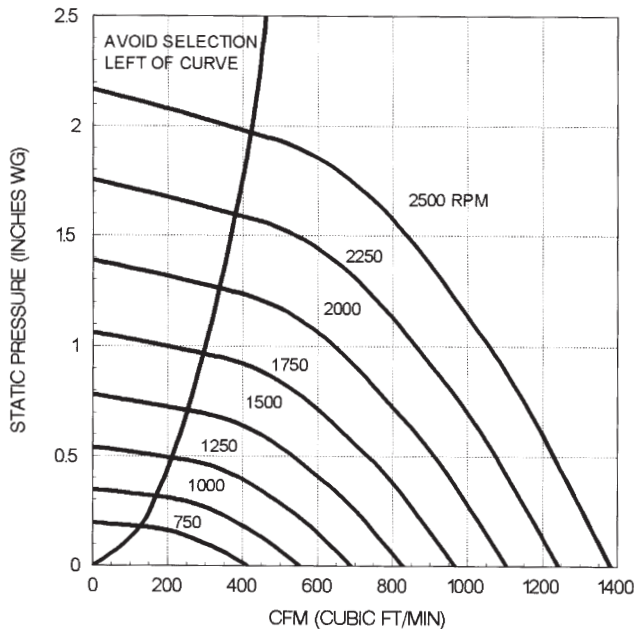

Performance certified is for installation type A - free inlet, free outlet.  
Performance ratings (bhp) do not include transmission losses.  
Performance ratings do not include the effects of accessories.

**VWBK 06**  
**SOUND PERFORMANCE**

RPM	SP INCH W.G.	SOUND POWER RE 10 <sup>-12</sup> WATTS								
		OCTAVE BANDS								LWA
		1	2	3	4	5	6	7	8	
600	.000	40	39	36	37	34	30	26	22	39
	.125	58	57	51	49	47	43	39	35	52
1000	.000	58	56	52	49	48	44	40	36	53
	.125	58	57	51	49	47	43	39	35	52
1400	.000	65	62	61	58	55	55	51	46	62
	.500	68	68	64	62	59	56	52	47	65
1800	.000	71	67	70	65	63	60	59	54	69
	.375	71	69	70	65	62	59	57	53	68
	.750	74	74	73	68	66	62	59	54	71
2100	.000	78	70	76	69	67	63	63	58	73
	.500	76	73	75	69	67	63	62	57	73
2300	1.000	79	78	78	71	70	65	63	58	75
	.000	81	73	78	71	70	65	66	61	75
	.500	79	76	77	72	69	65	64	60	75
2500	1.000	79	79	79	73	71	66	64	60	76
	.000	82	76	80	74	72	68	67	63	78
	.500	81	78	79	74	71	67	66	62	77
	1.000	79	80	80	75	71	68	66	62	78
	1.500	83	84	84	78	75	71	68	64	81

The sound power level ratings shown are in decibels, referred to 10<sup>-12</sup> watts calculated per AMCA Standard 301. Values shown are for inlet L<sub>wi</sub> sound power levels for installation Type A free inlet, free outlet. Ratings do not include the effects of duct end correction. The A-weighted sound ratings shown have been calculated per AMCA International Standard 301

**VWBK 08**  
**SOUND PERFORMANCE**

RPM	SP INCH W.G.	SOUND POWER RE 10 <sup>-12</sup> WATTS								
		OCTAVE BANDS								LWA
		1	2	3	4	5	6	7	8	
650	.000	52	57	42	41	39	40	38	37	47
	.125	69	68	66	54	52	50	50	48	61
1050	.000	69	68	66	54	52	50	50	48	61
	.250	68	70	62	53	51	48	46	41	60
1450	.000	69	71	70	63	58	57	58	59	67
	.500	69	68	65	60	58	57	55	53	65
1800	.000	80	74	79	70	65	61	62	63	74
	.500	79	73	74	66	63	60	60	59	71
	1.000	76	73	72	66	64	63	61	57	71
2100	.000	87	76	86	75	69	65	65	66	80
	.500	86	77	82	71	68	64	64	64	77
2300	1.000	83	77	80	70	68	65	64	62	75
	.000	90	79	88	78	72	67	67	68	82
	.750	88	80	84	74	70	66	65	65	79
2500	1.500	84	80	81	73	71	68	67	64	78
	.000	91	83	89	82	75	69	69	70	84
	.500	90	83	87	79	74	69	68	68	82
	1.000	89	83	85	77	73	68	67	67	81
	1.750	86	83	83	76	73	70	69	66	80

The sound power level ratings shown are in decibels, referred to 10<sup>-12</sup> watts calculated per AMCA Standard 301. Values shown are for inlet L<sub>wi</sub> sound power levels for installation Type A free inlet, free outlet. Ratings do not include the effects of duct end correction. The A-weighted sound ratings shown have been calculated per AMCA International Standard 301

**VWBK 10**  
AIR PERFORMANCE

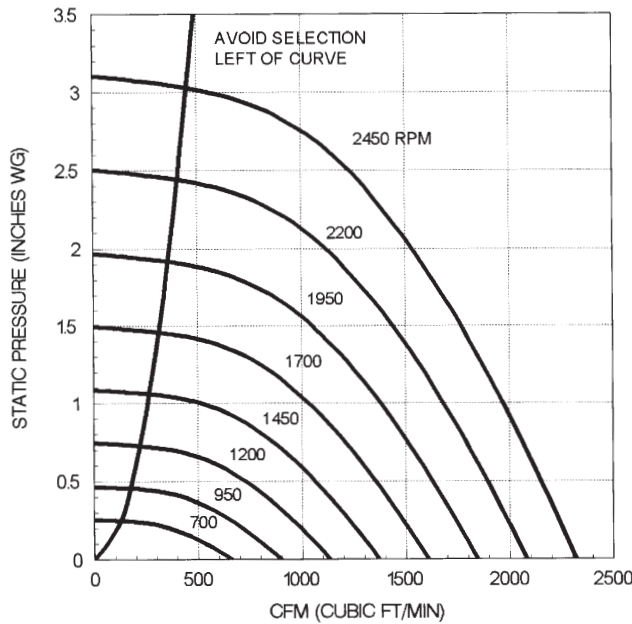

Performance certified is for installation type A - free inlet, free outlet.  
Performance ratings (bhp) do not include transmission losses.  
Performance ratings do not include the effects of accessories.

**VWBK 12**  
AIR PERFORMANCE

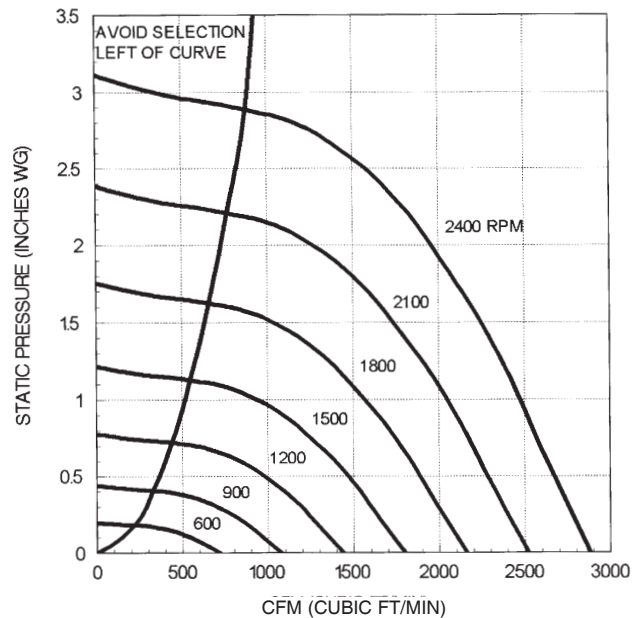

Performance certified is for installation type A - free inlet, free outlet.  
Performance ratings (bhp) do not include transmission losses.  
Performance ratings do not include the effects of accessories.

**VWBK 10**  
SOUND PERFORMANCE

RPM	SP INCH W.G.	SOUND POWER RE 10 <sup>-12</sup> WATTS								
		OCTAVE BANDS								LWA
		1	2	3	4	5	6	7	8	
650	.000	52	55	50	47	47	44	37	31	51
	.375	63	65	60	55	53	51	49	46	60
950	.000	64	69	69	65	62	62	59	51	69
	.375	67	70	67	63	60	60	56	50	67
	.750	68	70	66	62	59	60	58	53	67
1300	.000	72	74	76	72	68	67	67	59	75
	.625	71	78	74	70	66	65	64	58	73
	1.250	72	78	73	69	65	64	64	60	73
1650	.000	78	78	82	78	73	71	73	65	81
	.500	76	82	81	77	72	69	70	64	80
	1.000	74	84	80	76	71	69	69	64	79
	2.000	76	84	80	75	70	68	69	65	78
2000	.000	81	84	85	83	78	75	76	71	85
	.500	79	86	86	82	77	74	74	69	84
	1.000	78	87	86	82	76	73	73	68	84
	2.000	75	87	85	80	75	72	73	70	83
	2.500	76	87	85	80	75	72	73	70	83

The sound power level ratings shown are in decibels, referred to 10<sup>-12</sup> watts calculated per AMCA Standard 301. Values shown are for inlet L<sub>wi</sub> sound power levels for installation Type A free inlet, free outlet. Ratings do not include the effects of duct end correction. The A-weighted sound ratings shown have been calculated per AMCA International Standard 301

**VWBK 12**  
SOUND PERFORMANCE

RPM	SP INCH W.G.	SOUND POWER RE 10 <sup>-12</sup> WATTS								
		OCTAVE BANDS								LWA
		1	2	3	4	5	6	7	8	
550	.000	53	50	46	48	48	40	30	20	51
	.375	67	67	64	57	56	54	50	44	62
950	.000	70	77	74	68	65	67	60	50	73
	.375	69	77	73	67	64	65	58	51	71
	.750	69	77	73	67	62	62	58	52	70
1250	.000	72	85	82	76	69	74	69	59	80
	.750	71	85	81	75	67	68	65	59	78
	1.250	74	86	80	75	66	67	65	60	78
1600	.000	75	87	88	83	76	77	75	66	85
	.750	75	87	87	82	74	74	72	65	84
	1.250	75	87	87	82	74	72	70	65	84
	1.750	77	88	87	82	73	71	70	66	83
1950	.000	78	88	92	88	80	79	79	71	89
	1.000	77	88	92	87	79	77	76	70	88
	1.500	77	88	92	87	79	75	74	70	88
	2.000	79	89	92	86	79	75	74	70	88
	2.500	80	90	92	86	78	74	74	70	88

The sound power level ratings shown are in decibels, referred to 10<sup>-12</sup> watts calculated per AMCA Standard 301. Values shown are for inlet L<sub>wi</sub> sound power levels for installation Type A free inlet, free outlet. Ratings do not include the effects of duct end correction. The A-weighted sound ratings shown have been calculated per AMCA International Standard 301

**VWBK 15**  
**AIR PERFORMANCE**

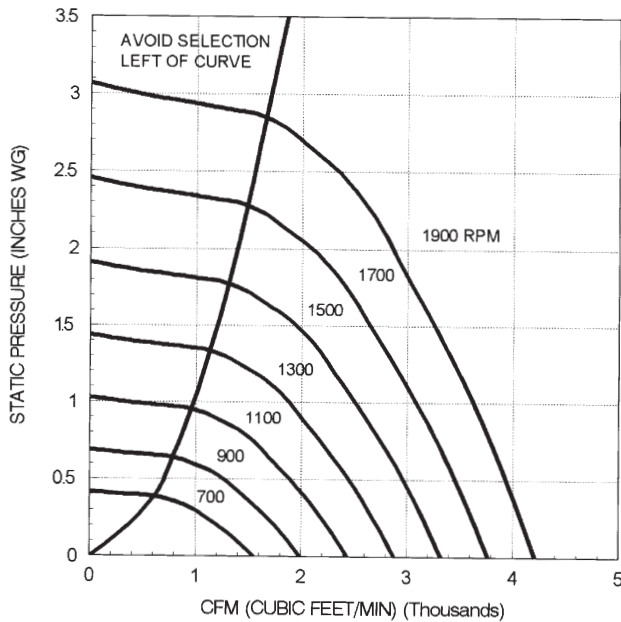

Performance certified is for installation type A - free inlet, free outlet.  
Performance ratings (bhp) do not include transmission losses.  
Performance ratings do not include the effects of accessories.

**VWBK 18**  
**AIR PERFORMANCE**

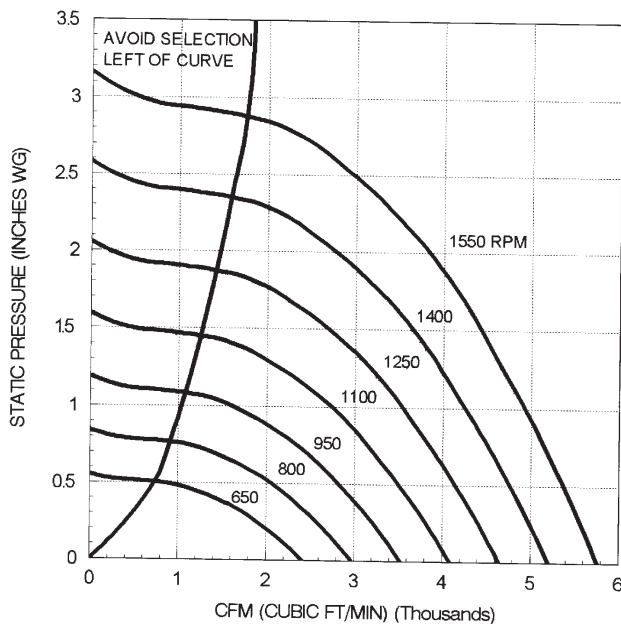

Performance certified is for installation type A - free inlet, free outlet.  
Performance ratings (bhp) do not include transmission losses.  
Performance ratings do not include the effects of accessories.

**VWBK 15**  
**SOUND PERFORMANCE**

RPM	SP INCH W.G.	SOUND POWER RE 10 <sup>-12</sup> WATTS								
		OCTAVE BANDS								LWA
		1	2	3	4	5	6	7	8	
550	.000	62	64	60	55	53	48	41	33	58
800	.000	73	75	72	67	63	59	53	45	70
	.375	72	74	71	68	64	60	55	49	70
1050	.000	80	81	81	76	70	67	61	54	77
	.375	79	80	79	76	71	67	62	56	77
	.750	81	79	79	76	72	68	63	58	78
1300	.000	84	87	87	82	76	72	68	61	84
	.750	83	86	86	82	78	73	68	63	84
	1.250	85	86	85	82	78	74	70	64	84
1550	.000	87	92	93	88	82	77	73	67	89
	.750	86	91	92	87	82	78	73	67	87
	1.250	87	91	91	87	83	78	74	68	89
	1.750	88	91	91	87	83	79	74	70	89
1750	.000	89	95	96	92	85	80	77	71	93
	1.000	88	94	95	91	86	81	76	71	92
	1.500	89	95	94	90	86	81	77	72	92
	2.000	89	95	94	90	86	82	78	73	92
	2.500	90	95	94	90	87	82	78	73	92

The sound power level ratings shown are in decibels, referred to 10<sup>-12</sup> watts calculated per AMCA Standard 301. Values shown are for inlet L<sub>wi</sub> sound power levels for installation Type A free inlet, free outlet. Ratings do not include the effects of duct end correction. The A-weighted sound ratings shown have been calculated per AMCA International Standard 301

**VWBK 18**  
**SOUND PERFORMANCE**

RPM	SP INCH W.G.	SOUND POWER RE 10 <sup>-12</sup> WATTS								
		OCTAVE BANDS								LWA
		1	2	3	4	5	6	7	8	
550	.000	67	66	59	59	58	53	46	39	62
750	.000	76	75	70	66	66	62	56	49	70
	.500	72	70	64	59	58	56	52	46	64
950	.000	78	81	76	72	71	69	64	58	76
	.375	78	79	75	70	68	66	61	55	74
	.625	76	78	73	68	66	64	60	56	72
1150	.000	84	85	84	77	75	74	69	64	82
	1.000	82	82	80	72	70	69	65	61	77
	1.500	81	81	79	72	69	68	65	61	76
1350	.000	88	89	90	81	79	78	74	69	86
	1.000	87	87	87	78	75	74	71	66	83
	1.500	86	86	85	76	73	72	70	66	81
	2.000	86	85	85	76	73	72	69	66	81
1500	.000	91	91	94	84	81	81	77	72	89
	1.000	90	90	92	82	79	78	74	69	87
	1.500	89	89	90	80	77	76	73	69	86
	2.000	88	88	89	79	75	75	72	68	84
	2.500	89	88	89	79	75	75	72	68	84

The sound power level ratings shown are in decibels, referred to 10<sup>-12</sup> watts calculated per AMCA Standard 301. Values shown are for inlet L<sub>wi</sub> sound power levels for installation Type A free inlet, free outlet. Ratings do not include the effects of duct end correction. The A-weighted sound ratings shown have been calculated per AMCA International Standard 301

## VWBK 21 AIR PERFORMANCE

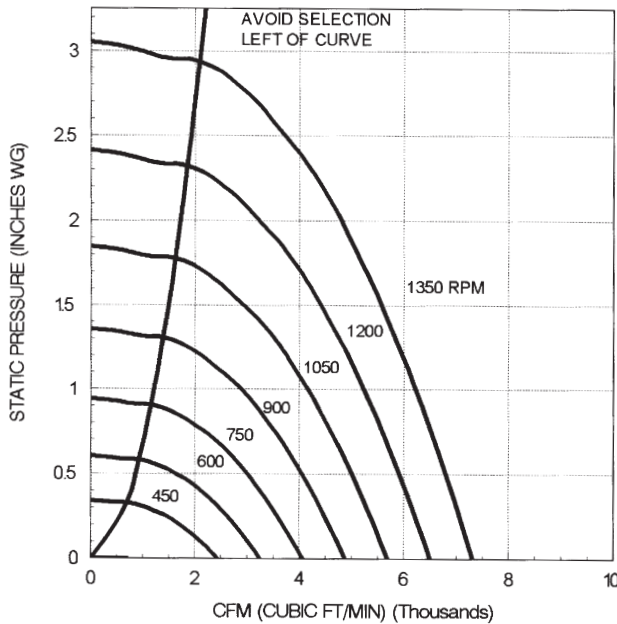

Performance certified is for installation type A - free inlet, free outlet.  
Performance ratings (bhp) do not include transmission losses.  
Performance ratings do not include the effects of accessories.

## VWBK 24 AIR PERFORMANCE

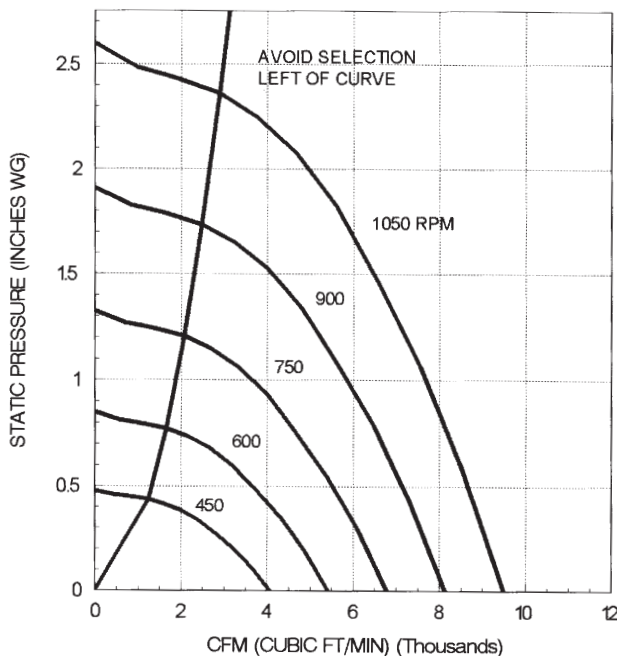

Performance certified is for installation type A - free inlet, free outlet.  
Performance ratings (bhp) do not include transmission losses.  
Performance ratings do not include the effects of accessories.

## VWBK 21 SOUND PERFORMANCE

RPM	SP INCH W.G.	SOUND POWER RE 10 <sup>-12</sup> WATTS OCTAVE BANDS								LWA
		1	2	3	4	5	6	7	8	
400	.000	59	59	57	57	55	50	43	37	59
	.500	68	72	66	66	67	62	56	49	70
775	.000	77	77	75	72	72	69	64	57	76
	.375	77	77	73	69	68	66	61	55	74
	.750	78	77	72	66	67	66	61	54	73
950	.000	84	82	82	77	76	75	70	64	82
	.500	84	82	80	74	73	72	67	61	79
	1.250	85	83	80	71	71	72	67	60	78
1125	.000	90	85	87	81	79	80	75	69	86
	1.000	89	87	86	77	75	77	72	66	83
	1.500	90	87	86	76	74	76	73	66	83
	2.000	90	87	86	76	74	76	73	68	83
1300	.000	93	90	91	85	83	83	79	73	90
	1.000	91	91	90	83	80	80	76	71	88
	1.500	92	91	90	82	78	79	76	70	87
	2.000	93	92	90	81	77	79	77	70	87
	2.750	93	92	90	80	77	79	77	70	87

The sound power level ratings shown are in decibels, referred to 10<sup>-12</sup> watts calculated per AMCA Standard 301. Values shown are for inlet L<sub>wj</sub> sound power levels for installation Type A free inlet, free outlet. Ratings do not include the effects of duct end correction. The A-weighted sound ratings shown have been calculated per AMCA International Standard 301

## VWBK 24 SOUND PERFORMANCE

RPM	SP INCH W.G.	SOUND POWER RE 10 <sup>-12</sup> WATTS OCTAVE BANDS								LWA
		1	2	3	4	5	6	7	8	
400	.000	69	68	61	59	60	59	50	40	65
	.500	76	78	72	67	66	67	61	51	73
550	.375	75	75	68	64	64	62	57	50	69
	.625	74	75	67	62	63	62	56	50	68
	1.000	82	84	80	73	71	72	70	60	79
700	.500	81	82	78	71	69	69	64	58	76
	.750	82	81	77	69	68	69	64	57	75
	1.000	82	81	77	68	68	68	64	57	75
850	.000	87	89	87	78	75	76	76	67	84
	.500	86	88	85	77	73	75	72	65	82
	.750	86	87	85	76	72	75	70	64	82
	1.000	87	87	84	75	72	74	70	63	81
1000	1.500	87	86	84	73	71	73	70	63	81
	.000	90	93	92	84	79	80	81	73	89
	.500	90	92	91	83	78	79	78	71	87
	1.000	90	91	89	81	76	78	75	69	86
	1.500	90	91	89	80	76	77	75	68	85
2.000	91	90	89	79	75	77	74	68	85	

The sound power level ratings shown are in decibels, referred to 10<sup>-12</sup> watts calculated per AMCA Standard 301. Values shown are for inlet L<sub>wj</sub> sound power levels for installation Type A free inlet, free outlet. Ratings do not include the effects of duct end correction. The A-weighted sound ratings shown have been calculated per AMCA International Standard 301



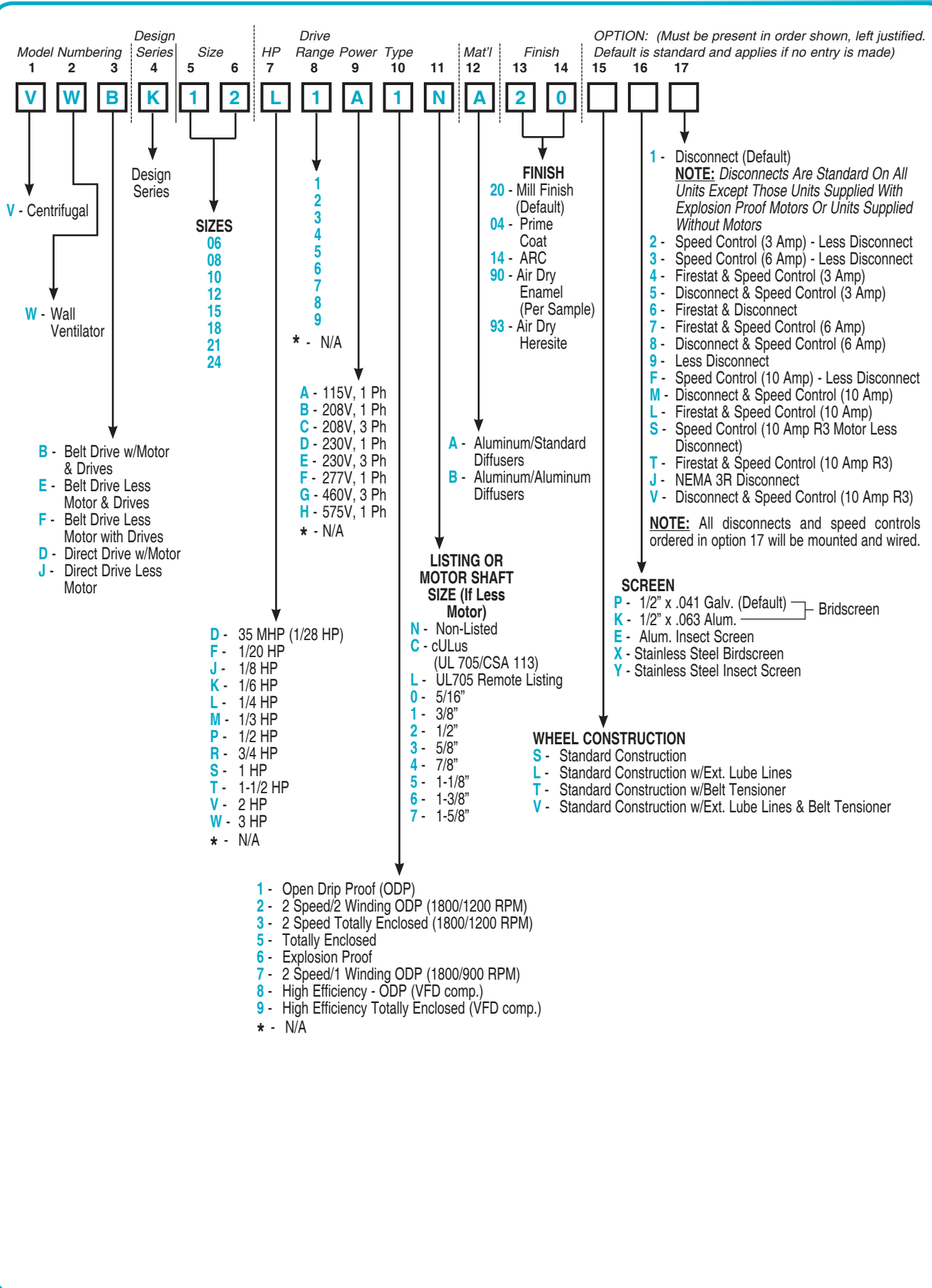

Cent. Power Wall Vents



▼ Wall Grilles

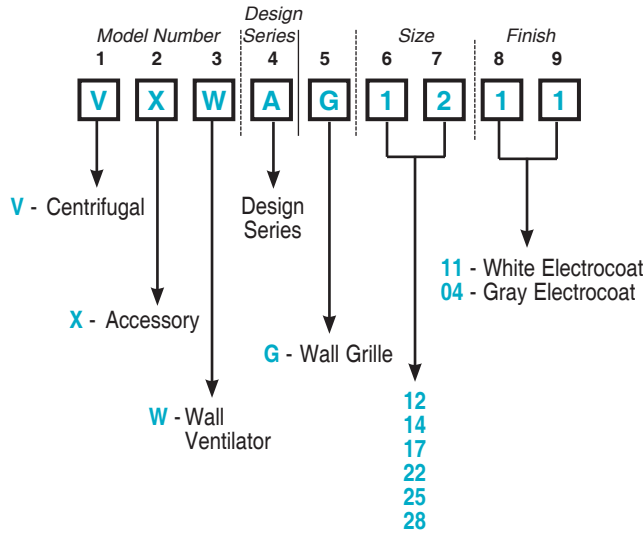

▼ Dampers

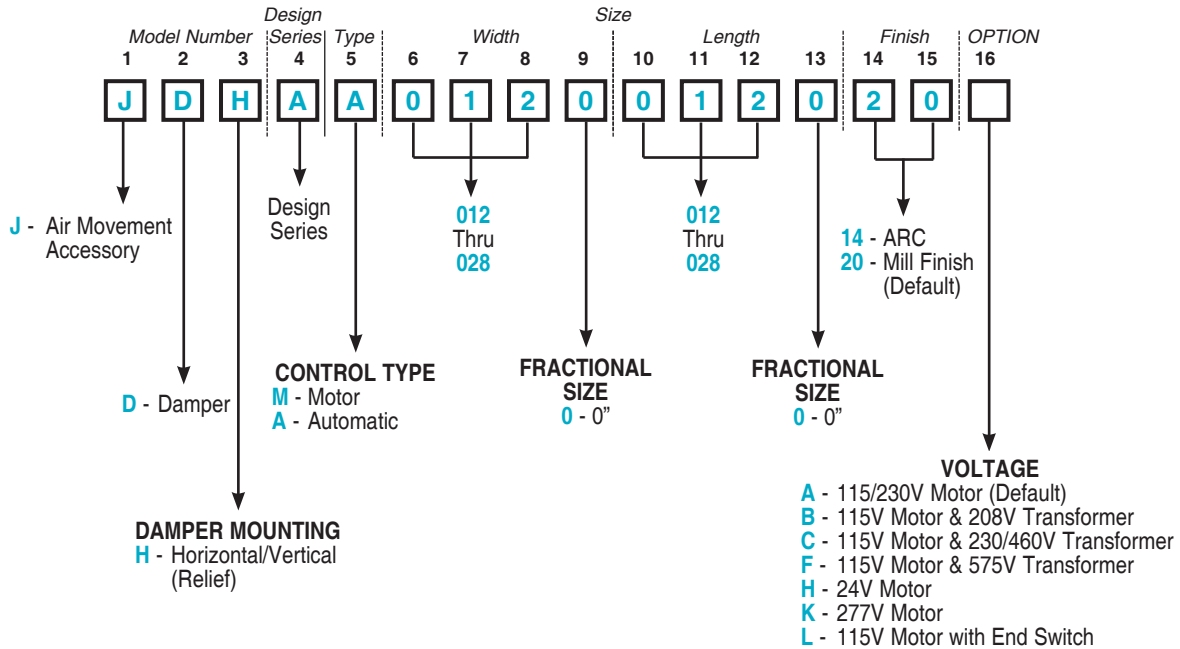

▼ **Electrical Accessories**

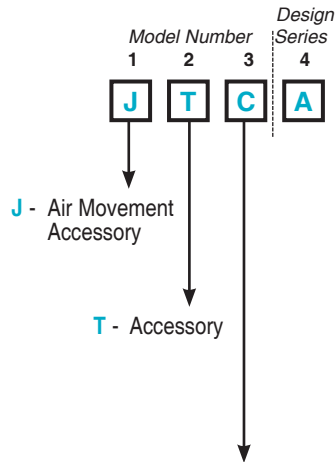
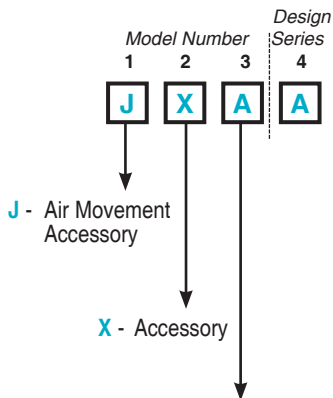

- DISCONNECT SWITCHES**
- A - Firestat
  - J - 3 Pole, 3 Phase, Explosion Proof (EX3)
  - K - 2 Pole, 1 Phase, Explosion Proof (EX2)
  - L - 2 Pole, 1 Phase, Safety Disconnect (DS2)
  - M - 3 Pole, 3 Phase, Safety Disconnect (DS3)
  - N - 3 Pole, 3 Phase, NEMA (K-3) with Lock Out
  - P - 2 Speed, 6 Pole NEMA 3R Non-Fusible
  - F - Raintight - NEMA 3R - 2 Pole, 1ø, 120-230V, 1/2 to 2 HP
  - H - Raintight - NEMA 3R - 3 Pole, 3ø, 208-460V
- SPEED CONTROLS**
- U - Solid State Speed Controller - 3 Amp (115V/1ø)
  - V - Solid State Speed Controller - 6 Amp (115V/1ø)
  - W - Solid State Speed Controller - 10 Amp (115V/1ø)
  - Y - Solid State Speed Controller - 10 Amp (115V/1ø) (R3 Motor)

- A - 2 Pole, 1 Phase - NEMA 4 - Watertight Disconnect
- B - 3 Pole, 3 Phase - NEMA 4 - Watertight Disconnect
- C - Line Voltage Thermostat with Coiled Capillary
- D - Line Voltage Thermostat with 22" Capillary and Remote Bulb
- N - 2/3 Pole, 1 or 3 Phase NEMA4X Disconnect

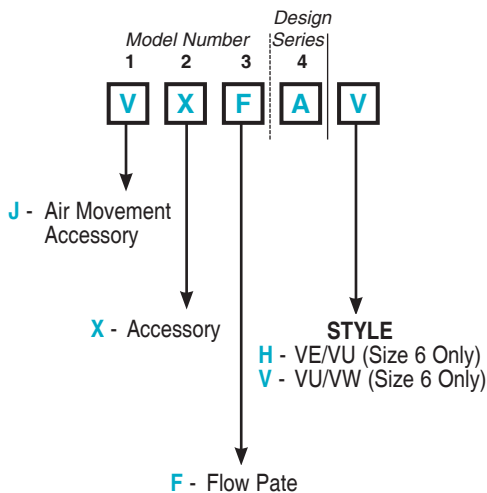

Cent. Power Wall Vents