

Application

The EFD-635 drainable blade louver is designed to prevent water penetration in non-wind-driven rain applications by collecting water in frame and blade gutters and channeling it into downspouts and away from airflow paths. The EFD-635 is available in a wide array of anodized and painted finishes including custom color matching.

Standard Construction

Material: Mill finish 6063-T5 extruded aluminum.

Frame: 6" deep × 0.081" thick (152 × 2) channel.

Blades: 35° × 0.081" thick (2) drainable style.

Screen: 1/2" × 0.063" (12.7 × 1.6) expanded and flattened aluminum.

Minimum Size: 4.5" × 8" (114 × 203)

Maximum Size: Single section: 60" × 120" (1524 × 3048)
120" × 60" (3048 × 1524)
Multiple section: Unlimited

Shipping Weight (Approximate): 5.1 lbs/ft² (24.9 kg/m²)

Options

- Factory finish:
 - High Performance Fluoropolymer - 100% resin Newlar®/ 70% resin Kynar®
 - Baked Enamel
 - Clear or Color Anodized, Class 1
 - Prime Coat
- Hidden vertical mullion for continuous blade appearance.
- Flange frame:
 - 1 1/2" (38) flange frame
 - Custom-size flange
 - Stucco flange
 - 1" × 3/4" (25 × 19) glazing frame
- Welded construction.
- Alternate bird or insect screens:
 - Standard mount Removable
- Insulated or non-insulated blank-off panels.
- Filter racks.
- Hinged frame.
- Head and/or sill flashing.
- Installation hardware:
 - Clip angles Continuous angles
- Burglar bars:
 - Shipped loose Shipped mounted
- Frame closure.

Ratings

Free Area: [48" × 48" (1219 × 1219) unit]: 9.7 ft² (0.90 m²)
60.7%

Performance @ Beginning Point of Water Penetration

Free Area Velocity: 1250 fpm (6.35 m/s)
Air Volume Delivered: 12,138 cfm (5.72 m³/s)
Pressure Loss: 0.20 in.wg. (50 Pa)

Velocity @ 0.15 in.wg. Pressure Loss: 1099 fpm (5.58 m/s)

Std. Design Load: 30 psf

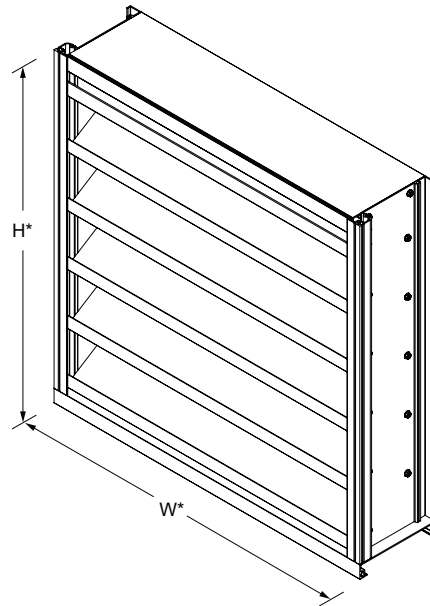

Model **EFD-635**
(standard)

*Louvers dimensions furnished approximately 1/2" (13) undersize.

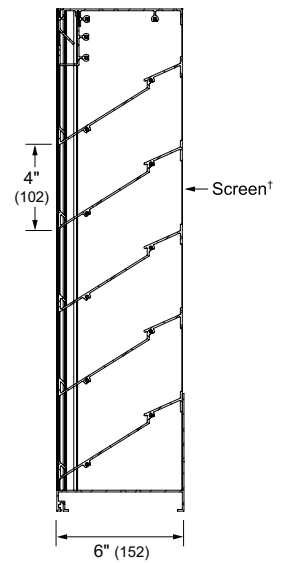

Vertical Section

*Screen adds approximately 3/16" (5) to louver depth.

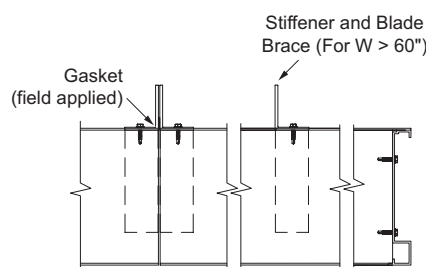

Hidden Vertical Mullion
(optional)

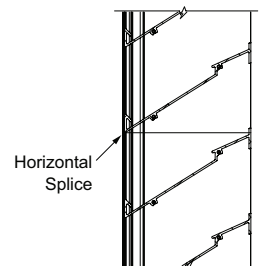

Horizontal Mullion
(standard)

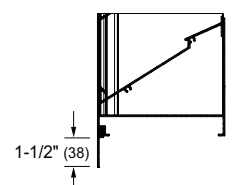

Flange Frame
(optional)



Certified Ratings:

Pottorff certifies that the model EFD-635 shown herein is licensed to bear the AMCA seal. The ratings shown are based on test and procedures performed in accordance with AMCA Publication 511 and comply with the requirements of the AMCA Certified Ratings Program. The AMCA Certified Ratings seal applies to air performance and water penetration ratings.

Performance Data

Free Area (ft²)

Width (Inches)

Height (Inches)	4.5	12	18	24	30	36	42	48	54	60	66	72	78	84	90	96	102	108	114	120
8	0.05	0.19	0.3	0.4	0.5	0.7	0.8	0.9	1.0	1.1	1.2	1.3	1.5	1.6	1.7	1.8	1.9	2.0	2.1	2.3
12	0.1	0.3	0.5	0.7	0.9	1.0	1.2	1.4	1.6	1.8	2.0	2.1	2.3	2.5	2.7	2.9	3.1	3.2	3.4	3.6
18	0.1	0.6	0.9	1.3	1.7	2.0	2.4	2.7	3.1	3.4	3.8	4.2	4.5	4.9	5.2	5.6	5.9	6.3	6.6	7.0
24	0.2	0.9	1.5	2.0	2.5	3.1	3.6	4.2	4.7	5.3	5.8	6.4	6.9	7.4	8.0	8.5	9.1	9.6	10.2	10.7
30	0.3	1.2	1.9	2.6	3.3	4.1	4.8	5.5	6.2	6.9	7.6	8.4	9.1	9.8	10.5	11.2	11.9	12.7	13.7	14.1
36	0.4	1.5	2.4	3.3	4.2	5.1	6.0	6.9	7.8	8.8	9.7	10.6	11.5	12.4	13.3	14.2	15.1	16.0	16.9	17.8
42	0.4	1.8	2.9	4.0	5.0	6.1	7.2	8.3	9.3	10.4	11.5	12.6	13.7	14.7	15.8	16.9	18.0	19.0	20.0	21.2
48	0.5	2.1	3.4	4.6	5.9	7.2	8.4	9.7	11.0	12.2	13.5	14.8	16.0	17.3	18.6	19.8	21.1	22.4	23.6	24.9
54	0.6	2.4	3.8	5.3	6.7	8.2	9.6	11.0	12.5	13.9	15.3	16.8	18.2	19.7	21.1	22.5	24.0	25.4	26.9	28.3
60	0.7	2.7	4.3	6.0	7.6	9.2	10.9	12.5	14.1	15.7	17.4	19.0	20.6	22.2	23.9	25.5	27.1	28.8	30.4	32.0
66	0.7	3.0	4.8	6.6	8.4	10.2	12.0	13.8	15.6	17.4	19.2	21.0	22.8	24.6	26.4	28.2	30.0	31.8	33.6	35.4
72	0.8	3.3	5.3	7.3	9.3	11.3	13.6	15.2	17.2	19.2	21.2	23.2	25.2	27.2	29.2	31.2	33.1	35.1	37.1	39.1
78	0.9	3.6	5.8	7.9	10.1	12.2	14.4	16.6	18.7	20.9	23.0	25.2	27.4	29.5	31.7	33.9	36.0	38.2	40.3	42.5
84	1.0	3.9	6.3	8.6	11.0	13.3	15.7	18.0	20.4	22.7	25.1	27.4	29.8	32.1	34.5	36.8	39.2	41.5	43.9	46.2
90	1.1	4.2	6.7	9.2	11.8	14.3	16.8	19.3	21.9	24.4	26.9	29.4	31.9	34.5	37.0	39.5	42.0	44.6	47.1	49.6
96	1.1	4.5	7.2	9.9	12.6	15.4	18.1	20.8	23.5	26.2	28.9	31.6	34.3	37.0	39.8	42.5	45.2	47.9	50.6	53.3
102	1.2	4.8	7.7	10.6	13.5	16.3	19.2	22.1	25.0	27.9	30.8	33.6	36.5	39.4	42.3	45.2	48.0	50.9	53.8	56.7
108	1.3	5.1	8.2	11.3	14.3	17.4	20.5	23.5	26.6	29.7	32.8	35.8	38.9	42.0	45.0	48.1	51.2	54.3	57.3	60.4
114	1.4	5.4	8.7	11.9	15.1	18.4	21.6	24.9	28.1	31.4	34.6	37.8	41.1	44.3	47.6	50.8	54.1	57.3	60.6	63.8
120	1.4	5.7	9.2	12.6	16.0	19.5	22.9	26.3	29.7	33.2	36.6	40.0	43.5	46.9	50.3	53.8	57.2	60.6	64.1	67.5



Certified Ratings:
 Potliff certifies that the model EFD-635 shown herein is licensed to bear the AMCA seal. The ratings shown are based on test and procedures performed in accordance with AMCA Publication 511 and comply with the requirements of the AMCA Certified Ratings Program. The AMCA Certified Ratings seal applies to air performance and water penetration ratings.

Pressure Loss

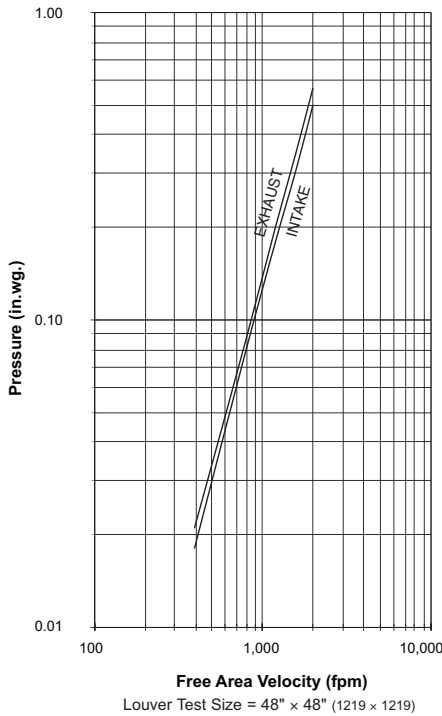

Selection Criteria

Follow the steps listed below to calculate the louver size needed to satisfy the required air volume while minimizing the adverse effects of water penetration and pressure loss.

- Determine the Free Area Velocity (FAV) at the maximum allowable pressure loss using the *Pressure Loss* chart to the left. While job conditions vary, typically, the maximum allowable pressure loss should not exceed 0.15 in.wg., and the FAV for 0.15 in.wg. pressure loss is listed on the front page of this sheet.
- Intake Applications** If the FAV at the Beginning Point of Water Penetration (shown below) is less than the FAV from step 1, then use the FAV at the Beginning Point of Water Penetration in step 3, otherwise use the FAV from step 1.

Exhaust Applications Use the FAV from step 1 in step 3.

- Calculate the total louver square footage required using the following equation.

$$\frac{\text{Required Air Volume (cfm)}}{\text{FAV (fpm)}} = \frac{\text{Required Louver (Free-Area) Size (ft}^2\text{)}}{\text{ft}^2}$$

- Using the *Free Area* chart above, select a louver width and height that yields a free area ft² greater than or equal to the required louver size calculated in step 3.

Water Penetration

Beginning Point of Water Penetration = 1250 fpm

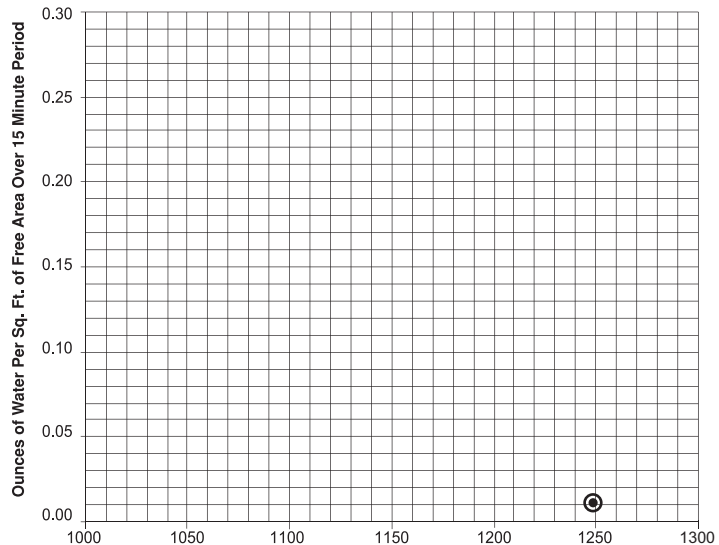

Water Penetration

AMCA defines the beginning point of water penetration as the free area velocity at the intersection of a simple linear regression of test data and the line of 0.01 ounces of water per square foot of free area and is measured through a 48" x 48" louver during a 15 minute period. The AMCA water penetration test provides a method for comparing louver models and designs as to their efficiency in resisting the penetration of rainfall under specific lab conditions. Potliff recommends that intake louvers are selected with a reasonable margin of safety below the beginning point of water penetration in order to avoid unwanted penetration during severe storm conditions.