

Florida Product Approved Wind-Driven Rain Louver

Application and Design

EHH-501X is a **Florida Product Approved** stationary horizontal blade wind driven rain extruded aluminum louver designed to protect air intake and exhaust openings in building exterior walls. EHH-501X is tested in accordance with AMCA 500-L Air Performance, Water Penetration and Wind Driven Rain. EHH-501X is tested in accordance with AMCA 540 Test Method for Louvers Impacted by Wind Borne Debris (Basic Protection, Missile Level D and Enhanced Protection, Missile Level E). **EHH-501X is licensed to bear the AMCA seal allowing design professionals to select and apply with confidence.** EHH-501X is tested and qualified per the following Florida test protocols: TAS 201 (Large Missile Impact), TAS 202 (Uniform Static Air Pressure) and TAS 203 (Cyclic Wind Loading). EHH-501X is approved by Florida for use in Florida's High Velocity Hurricane Zone. EHH-501X is qualified for wind loads up to 200 PSF (*size and configuration dependent, refer to the UL published certification for size and design load rating restrictions*).

Standard Construction

- Frame** Heavy gauge extruded 6063-T5 aluminum alloy, 5 in. x 0.081 in nominal wall thickness
- Blades** Horizontal rain resistant style, heavy gauge extruded 6063-T5 aluminum alloy, 0.081 in. nominal wall thickness, 2 in. blade spacing
- Construction** . . . Mechanically fastened
- Birdscreen** 3/4 in. x 0.051 in. flattened expanded aluminum in removable frame, inside mount (rear)
- Sill Pan** Formed aluminum
- Finish** Mill
- Angles** Continuous, Ship Loose (mill finish)
- Minimum Size** . . 12 in. W x 7 in. H

Maximum Single Section Size . . . 84 in. W x 144 in. H. or 120 in. W x 84 in. H.

Options (at additional cost)

- A variety of bird and insect screens
- Blank-off panel
- Filter rack
- Flanged frame
- Security bars
- Qualified shapes (*only rectangular shapes maintain AMCA certification*)
- Welded construction (*Large Missile Impact Qualified*)
- A variety of architectural finishes including:
 - Clear anodize
 - Integral color anodize
 - Baked enamel paint
 - Kynar paint

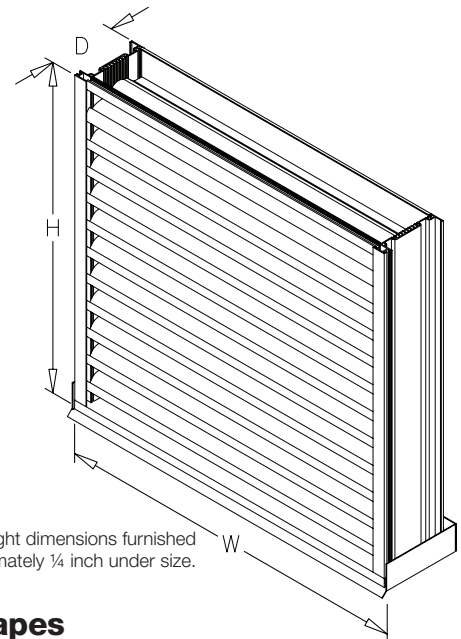
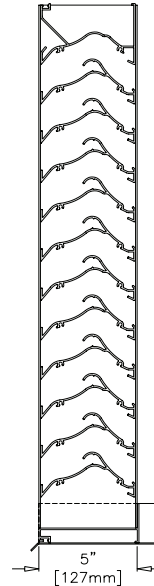

*Width and height dimensions furnished approximately 1/4 inch under size.

Qualified Shapes

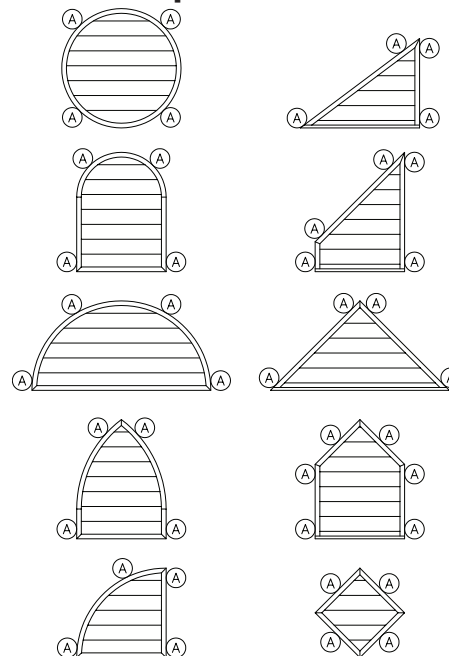

(A) Anchor points

This label does not signify AMCA airflow performance certification.

PERFORMANCE DATA

EHH-501X

Florida Product Approval No: FL6876.2,15718.2

UL Classified: R25119

Wind-Driven Rain Performance

Free Area Ventilation Rate fpm (m/s)	Ventilation Air Core Velocity fpm (m/s)	76 mm/h (3 in/hr) Rainfall & 13 m/s (29 mph) Wind Velocity		202.4 mm/h (8 in/hr) Rainfall & 22 m/s (50 mph) Wind Velocity	
		Water Penetration Effectiveness %	Water Penetration Classification	Water Penetration Effectiveness %	Water Penetration Classification
0 (0)	0 (0)		A		A
198 (1.0)	98 (0.5)		A		A
397 (2.0)	197 (1.0)		A		A
595 (3.0)	295 (1.5)		A		A
795 (4.0)	394 (2.0)		A		A
992 (5.0)	492 (2.5)		A	99.1	A
1,192 (6.1)	591 (3.0)	99.7	A	99.2	A
1,390 (7.1)	689 (3.5)	99.4	A	99.2	A
1,587 (8.1)	787 (4.0)	99.1	A	98.9	B
1,787 (9.1)	886 (4.5)	98.7	B	98.7	B
1,985 (10.1)	984 (5.0)	97.9	B	94.4	C

Discharge Loss Coefficient Class (Intake) = 2

Weather louvers shall be classified by their ability to reject simulated rain. The table shows different classifications based on the maximum simulated rain penetration per square meter (square feet) of louver. Water penetration rating at a given louver face velocity is determined by the water penetration while the louver is subjected to a selected simulated rainfall rate and wind velocity.

Airflow Resistance (Standard Air - .075 lb/ft³)

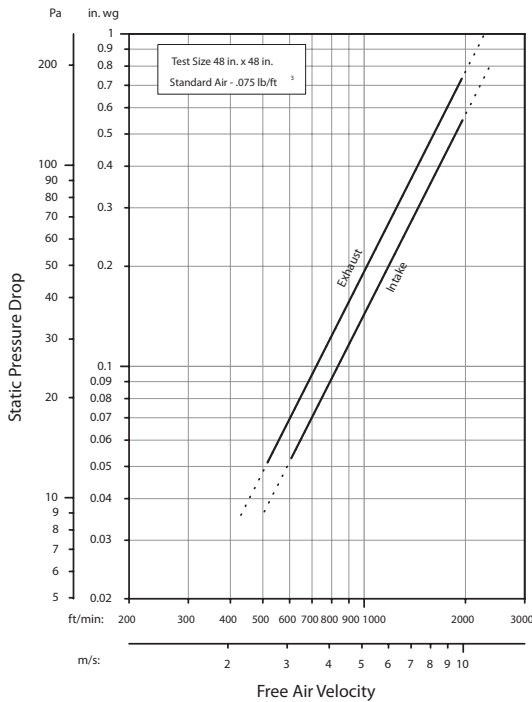

Model EHH-501X resistance to airflow (pressure drop) varies depending on louver application (air intake or air exhaust). Free area velocities (shown) are higher than average velocity through the overall louver size. See louver selection information. (Test Figure 5.5-6.5)

Water Penetration

Test Size 48 in. x 48 in. Test Duration of 15 min.

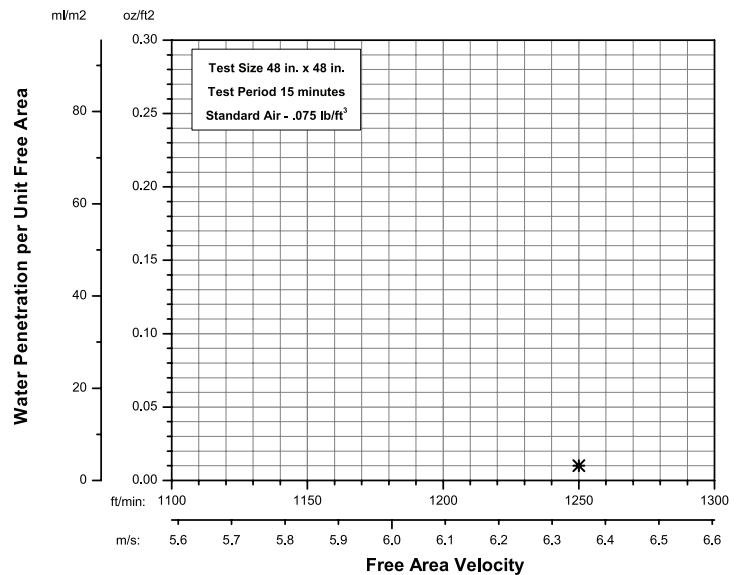

The AMCA Water Penetration Test provides a method for comparing various louver models and designs as to their efficiency in resisting the penetration of rainfall under specific laboratory test conditions. The beginning point of water penetration is defined as that velocity where the water penetration curve projects through 0.01 oz. of water (penetration) per sq. ft. of louver free area. *The beginning point of water penetration for Model EHH-501X is above 1250 fpm free area velocity. These performance ratings do not guarantee a louver to be weather-proof or stormproof and should be used in combination with other factors including good engineering judgement in selecting louvers.



Greenheck Fan Corporation certifies that the EHH-501X louvers shown herein are licensed to bear the AMCA Seal. The ratings shown are based on tests and procedures performed in accordance with AMCA Publication 511 and comply with the requirements of the AMCA Certified Ratings Program. The AMCA Certified Ratings Seal applies to air performance, water penetration, and wind-driven rain ratings.

IMPACT RESISTANT LOUVER
Enhanced Protection Level E

See www.AMCA.org for all certified or listed products

This label does not signify AMCA airflow performance certification.

Greenheck Fan Corporation certifies that the EHH-501X louvers shown herein are approved to bear the AMCA Listing Label. The Ratings shown are based on tests and procedures performed in accordance with AMCA Publications and comply with the requirements of the AMCA Listing Label Program. The AMCA Listing Label applies to Wind Borne Debris Impact Resistant Louvers.

Discharge Loss Coefficient Classifications	
Class	Discharge Loss Coefficient
1	0.4 and Above
2	0.3 to 0.399
3	0.2 to 0.299
4	0.199 and Below

Wind-driven Rain Penetration Classes	
Class	Effectiveness
A	1 to 0.99
B	0.989 to 0.95
C	0.949 to 0.80
D	Below 0.80

PERFORMANCE DATA

EHH-501X

Florida Product Approval No: FL6876.2,15718.2

UL Classified: R25119

Free Area Chart (sq. ft.)

Louver Height Inches	Louver Width in Inches																		
	12	18	24	30	36	42	48	54	60	66	72	78	84	90	96	102	108	114	120
7	0.06	0.11	0.15	0.19	0.23	0.27	0.31	0.34	0.38	0.42	0.46	0.50	0.54	0.58	0.62	0.65	0.69	0.73	0.77
12	0.20	0.33	0.45	0.58	0.71	0.83	0.96	1.05	1.18	1.30	1.43	1.56	1.68	1.81	1.93	2.03	2.16	2.28	2.41
18	0.41	0.66	0.91	1.17	1.42	1.68	1.93	2.12	2.38	2.63	2.89	3.14	3.39	3.65	3.90	4.09	4.35	4.60	4.86
24	0.61	0.99	1.38	1.76	2.14	2.52	2.91	3.19	3.58	3.96	4.34	4.72	5.11	5.49	5.87	6.16	6.54	6.92	7.31
30	0.81	1.33	1.84	2.35	2.86	3.37	3.88	4.26	4.77	5.29	5.80	6.31	6.82	7.33	7.84	8.22	8.73	9.25	9.76
36	1.02	1.66	2.30	2.94	3.58	4.22	4.85	5.33	5.97	6.61	7.25	7.89	8.53	9.17	9.81	10.29	10.93	11.57	12.21
42	1.22	1.99	2.76	3.53	4.29	5.06	5.83	6.40	7.17	7.94	8.71	9.47	10.24	11.01	11.78	12.35	13.12	13.89	14.66
48	1.43	2.32	3.22	4.12	5.01	5.91	6.80	7.47	8.37	9.27	10.16	11.06	11.95	12.85	13.75	14.42	15.31	16.21	17.10
54	1.63	2.66	3.68	4.70	5.73	6.75	7.78	8.54	9.57	10.59	11.62	12.64	13.67	14.69	15.71	16.48	17.51	18.53	19.55
60	1.84	2.99	4.14	5.29	6.45	7.60	8.75	9.62	10.77	11.92	13.07	14.22	15.38	16.53	17.68	18.55	19.70	20.85	22.00
66	2.04	3.32	4.60	5.88	7.16	8.44	9.73	10.69	11.97	13.25	14.53	15.81	17.09	18.37	19.65	20.61	21.89	23.17	24.45
72	2.25	3.65	5.06	6.47	7.88	9.29	10.70	11.76	13.17	14.57	15.98	17.39	18.80	20.21	21.62	22.68	24.08	25.49	26.90
78	2.45	3.99	5.52	7.06	8.60	10.14	11.67	12.83	14.36	15.90	17.44	18.98	20.51	22.05	23.59	24.74	26.28	27.81	29.35
84	2.65	4.32	5.99	7.65	9.32	10.98	12.65	13.90	15.56	17.23	18.89	20.56	22.22	23.89	25.56	26.80	28.47	30.14	31.80
90	2.86	4.65	6.45	8.24	10.03	11.83	13.62	14.97	16.76	18.55	20.35	22.14	23.94	25.73	27.52	28.87	30.66	32.46	34.25
96	3.06	4.99	6.91	8.83	10.75	12.67	14.60	16.04	17.96	19.88	21.80	23.73	25.65	27.57	29.49	30.93	32.86	34.78	36.70
102	3.27	5.32	7.37	9.42	11.47	13.52	15.57	17.11	19.16	21.21	23.26	25.31	27.36	29.41	31.46	33.00	35.05	37.10	39.15
108	3.47	5.65	7.83	10.01	12.19	14.37	16.54	18.18	20.36	22.54	24.71	26.89	29.07	31.25	33.43	35.06	37.24	39.42	41.60
114	3.68	5.98	8.29	10.60	12.90	15.21	17.52	19.25	21.56	23.86	26.17	28.48	30.78	33.09	35.40	37.13	39.43	41.74	44.05
120	3.88	6.32	8.75	11.19	13.62	16.06	18.49	20.32	22.75	25.19	27.63	30.06	32.50	34.93	37.37	39.19	41.63	44.06	46.50

Core Area Chart (sq. ft.)

Louver Height Inches	Louver Width in Inches																		
	12	18	24	30	36	42	48	54	60	66	72	78	84	90	96	102	108	114	120
7	0.18	0.30	0.41	0.53	0.64	0.76	0.87	0.99	1.10	1.22	1.33	1.44	1.56	1.67	1.79	1.90	2.02	2.13	2.25
12	0.52	0.84	1.16	1.49	1.81	2.13	2.46	2.78	3.10	3.42	3.75	4.07	4.39	4.72	5.04	5.36	5.68	6.01	6.33
18	0.92	1.49	2.06	2.64	3.21	3.78	4.36	4.93	5.50	6.08	6.65	7.22	7.79	8.37	8.94	9.51	10.09	10.66	11.23
24	1.32	2.14	2.97	3.79	4.61	5.43	6.26	7.08	7.90	8.73	9.55	10.37	11.20	12.02	12.84	13.66	14.49	15.31	16.13
30	1.72	2.79	3.87	4.94	6.01	7.09	8.16	9.23	10.30	11.38	12.45	13.52	14.60	15.67	16.74	17.81	18.89	19.96	21.03
36	2.12	3.45	4.77	6.09	7.41	8.74	10.06	11.38	12.71	14.03	15.35	16.67	18.00	19.32	20.64	21.97	23.29	24.61	25.93
42	2.52	4.10	5.67	7.24	8.81	10.39	11.96	13.53	15.11	16.68	18.25	19.83	21.40	22.97	24.54	26.12	27.69	29.26	30.84
48	2.92	4.75	6.57	8.39	10.22	12.04	13.86	15.68	17.51	19.33	21.15	22.98	24.80	26.62	28.45	30.27	32.09	33.91	35.74
54	3.33	5.40	7.47	9.54	11.62	13.69	15.76	17.84	19.91	21.98	24.05	26.13	28.20	30.27	32.35	34.42	36.49	38.56	40.64
60	3.73	6.05	8.37	10.70	13.02	15.34	17.66	19.99	22.31	24.63	26.96	29.28	31.60	33.92	36.25	38.57	40.89	43.22	45.54
66	4.13	6.70	9.27	11.85	14.42	16.99	19.56	22.14	24.71	27.28	29.86	32.43	35.00	37.58	40.15	42.72	45.29	47.87	50.44
72	4.53	7.35	10.17	13.00	15.82	18.64	21.47	24.29	27.11	29.93	32.76	35.58	38.40	41.23	44.05	46.87	49.70	52.52	55.34
78	4.93	8.00	11.08	14.15	17.22	20.29	23.37	26.44	29.51	32.59	35.66	38.73	41.80	44.88	47.95	51.02	54.10	57.17	60.24
84	5.33	8.65	11.98	15.30	18.62	21.95	25.27	28.59	31.91	35.24	38.56	41.88	45.21	48.53	51.85	55.17	58.50	61.82	65.14
90	5.73	9.30	12.88	16.45	20.02	23.60	27.17	30.74	34.31	37.89	41.46	45.03	48.61	52.18	55.75	59.33	62.90	66.47	70.04
96	6.13	9.96	13.78	17.60	21.42	25.25	29.07	32.89	36.72	40.54	44.36	48.18	52.01	55.83	59.65	63.48	67.30	71.12	74.95
102	6.53	10.61	14.68	18.75	22.83	26.90	30.97	35.04	39.12	43.19	47.26	51.34	55.41	59.48	63.55	67.63	71.70	75.77	79.85
108	6.93	11.26	15.58	19.90	24.23	28.55	32.87	37.20	41.52	45.84	50.16	54.49	58.81	63.13	67.46	71.78	76.10	80.42	84.75
114	7.34	11.91	16.48	21.05	25.63	30.20	34.77	39.35	43.92	48.49	53.06	57.64	62.21	66.78	71.36	75.93	80.50	85.08	89.65
120	7.74	12.56	17.38	22.21	27.03	31.85	36.67	41.50	46.32	51.14	55.97	60.79	65.61	70.43	75.26	80.08	84.90	89.73	94.55



INSTALLATION DETAILS

EHH-501X

Florida Product Approval No: FL6876.2,15718.2

UL Classified: R25119

Maximum Size and Installation Information

Model EHH-501X is a Florida Product Approved louver and must be installed in accordance with the installation instructions shown herein. Model EHH-501X is qualified for installation within concrete/masonry, steel stud, structural steel or wood framed building conditions. Model EHH-501X is structurally calculated to withstand positive and negative wind-loads up to 200 PSF. The louver section size will determine the actual maximum wind-load that the louver sections will withstand. The maximum single section size can be either 84 in. W x 144 in. H or 120 in. W x 84 in. H. The maximum opening width may be unlimited as multiple sections may be installed side by side in accordance with installation instructions. Structural reinforcing members along with any associated installation hardware is not provided by Greenheck unless indicated otherwise by Greenheck. Options and accessories are not subject to structural analysis unless indicated otherwise by Greenheck.

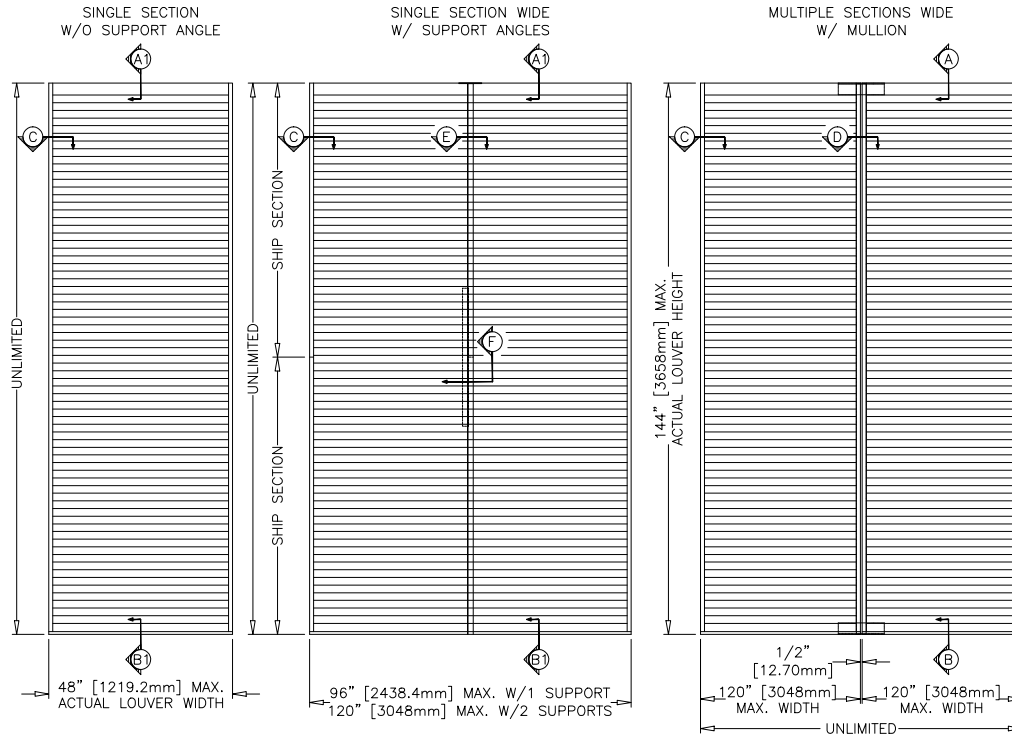

Minimum Single Section Size

12 in. W x 7 in. H

Maximum Single Section Size

84 in. W x 144 in. H. or
120 in. W x 84 in. H.

WOOD OPENING

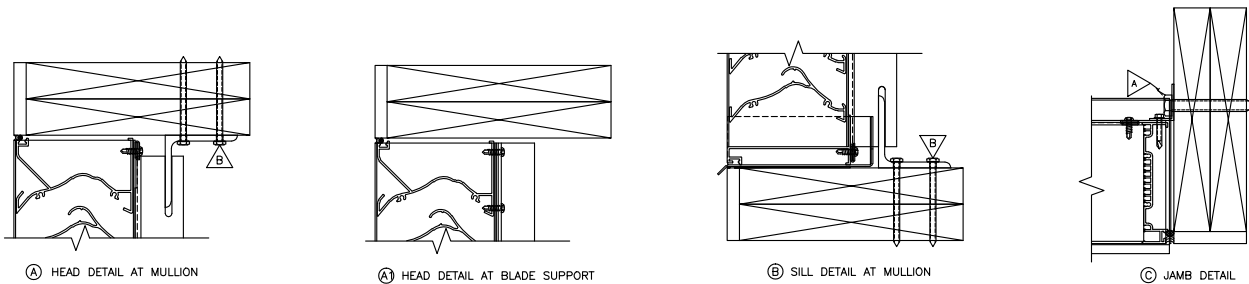

Concrete/Masonry Opening

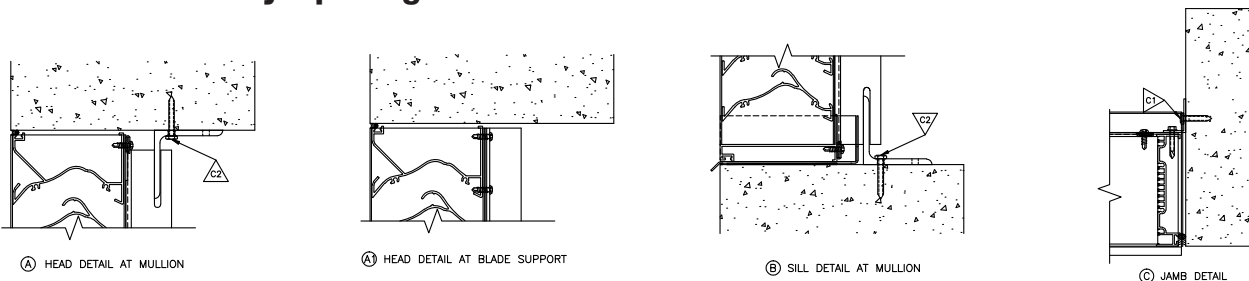

INSTALLATION DETAILS

EHH-501X

Florida Product Approval No: FL6876.2,15718.2

UL Classified: R25119

Steel Stud Opening

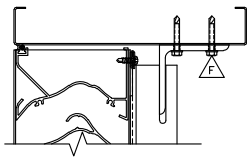

A HEAD DETAIL AT MULLION

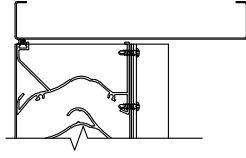

A HEAD DETAIL AT BLADE SUPPORT

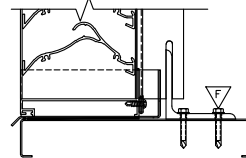

B SILL DETAIL AT MULLION

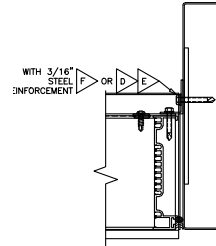

C JAMB DETAIL

Structural Steel Opening

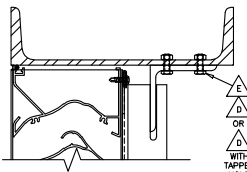

A HEAD DETAIL AT MULLION

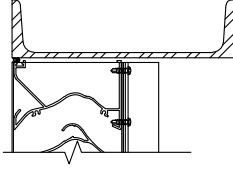

A HEAD DETAIL AT BLADE SUPPORT

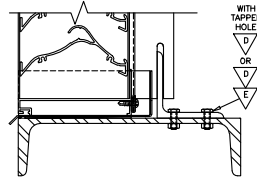

B SILL DETAIL AT MULLION

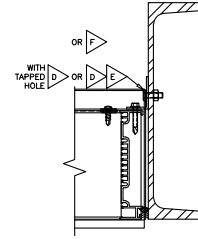

C JAMB DETAIL

FASTENER SCHEDULE (FIELD INSTALLED - NOT BY GREENHECK)

MOUNTING SUBSTRATE	FASTENER TYPE	DESCRIPTION	ANCHOR CLIP LOCATION	QUANTITY	MIN. EMBED.	MIN. EDGE DIST.	SPACING
WOOD	A	1/2" DIA. LAG SCREW	JAMB	VARIES	3"	2 1/2"	6.5"
WOOD	B	1/4" DIA. LAG SCREW	VERT. MULLION (HEAD/SILL)	12 PER CLIP	3"	1/2"	2"
CONCRETE	C1	1/4" DIA. TAPCON ANCH.	JAMB	VARIES	1.25"	1"	3.25"
CONCRETE	C2	1/4" DIA. TAPCON ANCH.	VERT. MULLION (HEAD/SILL)	7 PER CLIP	1.75"	2.5"	2"
MASONRY BLOCK	C1	1/4" DIA. TAPCON ANCH.	JAMB	VARIES	1.25"	1"	3.25"
MASONRY BLOCK	C2	1/4" DIA. TAPCON ANCH.	VERT. MULLION (HEAD/SILL)	7 PER CLIP	1.75"	2.5"	2"
STEEL STUD	D & E	1/4" DIA. BOLT & NUT	JAMB	VARIES	THRU BOLT	1/2"	6.5"
STEEL STUD (3/16" STEEL REINFORCED)	F	1/4" DIA. DRILL FLEX	JAMB	VARIES	FULL	1/2"	6.5"
STEEL STUD	G	1/4" DIA. DRILL FLEX	VERT. MULLION (HEAD/SILL)	12 PER CLIP	FULL	1/2"	2"
STRUCTURAL STEEL	D & E	1/4" DIA. BOLT & NUT	JAMB	VARIES	THRU BOLT	1/2"	6.5"
STRUCTURAL STEEL	D	1/4" DIA. BOLT	JAMB (FIELD DRILL & TAP HOLE)	VARIES	FULL	1/2"	6.5"
STRUCTURAL STEEL	F	1/4" DIA. DRILL FLEX	JAMB	VARIES	FULL	1/2"	6.5"
STRUCTURAL STEEL	D & E	1/4" DIA. BOLT & NUT	VERT. MULLION (HEAD/SILL)	4 PER CLIP	THRU BOLT	1/2"	6.5"
STRUCTURAL STEEL	D	1/4" DIA. BOLT	VERT. MULLION (HEAD/SILL) FIELD DRILL & TAP HOLE	4 PER CLIP	FULL	1/2"	6.5"
STRUCTURAL STEEL	F	1/4" DIA. DRILL FLEX	JAMB	VARIES	FULL	1/2"	6.5"

GENERAL NOTES:

- IT SHALL BE THE RESPONSIBILITY OF THE PERMIT HOLDER TO VERIFY THE STRUCTURAL INTEGRITY OF THE EXISTING STRUCTURE TO SUPPORT THE LOADS SUPERIMPOSED BY THE LOUVERS.
- INSTALLER TO PROVIDE SEPARATION OF DISSIMILAR MATERIALS AS REQUIRED.
- WOOD SUBSTRATE TO BE MINIMUM G = 0.42 DENSITY.
- CONCRETE SUBSTRATE TO BE MINIMUM 3,192 PSI CONCRETE OR 3,192 PSI GROUT FILLED ASTM C-90 HOLLOW BLOCK AT HEAD/SILL MULLION ANCHORS.
- CONCRETE SUBSTRATE TO BE MINIMUM 3,192 PSI CONCRETE OR ASTM C-90 HOLLOW BLOCK AT JAMB ANCHORS.
- STEEL STUD OPENINGS (16 GA. MINIMUM THICKNESS) TO BE MINIMUM Fy = 33 ksi.
- STRUCTURAL STEEL OPENINGS (1/4" MINIMUM THICKNESS) TO BE MINIMUM Fy = 36 ksi.

PRODUCT DETAILS

EHH-501X

Florida Product Approval No: FL6876.2,15718.2

UL Classified: R25119

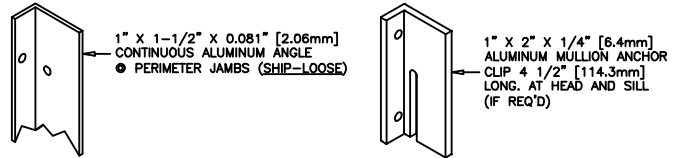
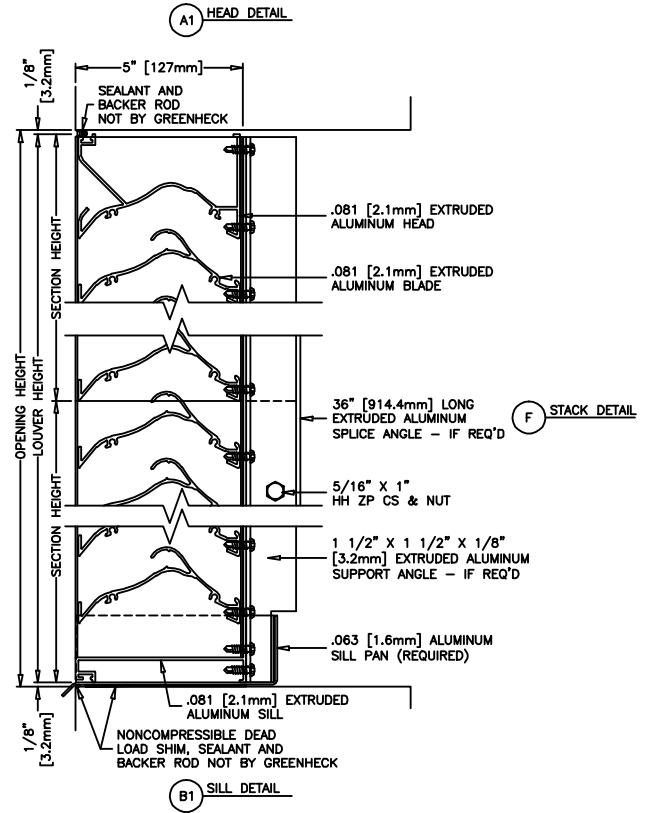
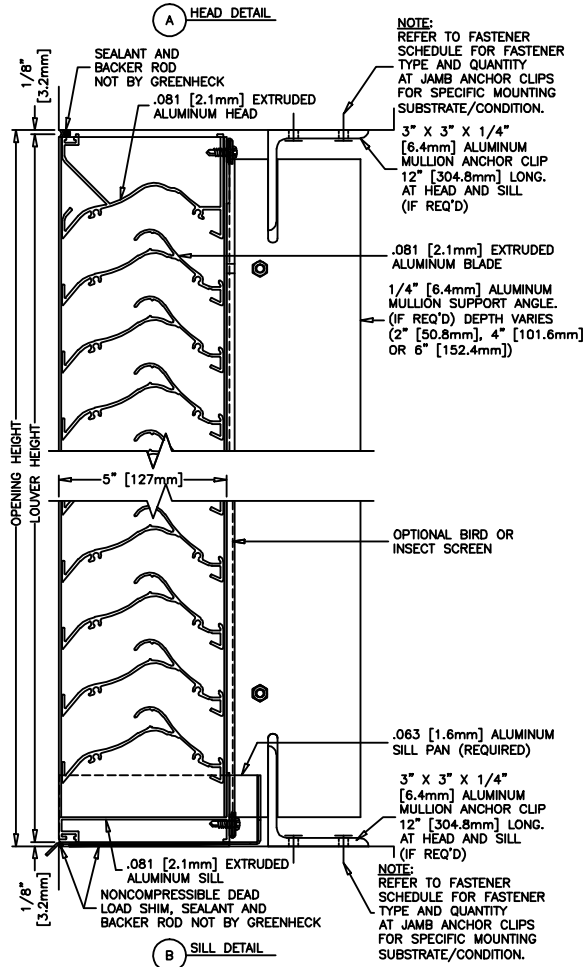

ALTERNATE JAMB CONFIGURATION (ADDITIONAL UNDERSIZING REQ'D, PLEASE CONSULT FACTORY)

SL 1/4-20 X 1-1/2" HILTI BOLT 416581

NOTE: REFER TO FASTENER SCHEDULE FOR FASTENER TYPE AND QUANTITY AT JAMB ANCHOR CLIPS FOR SPECIFIC MOUNTING SUBSTRATE/CONDITION.

1" X 1-1/2" X 0.081" [2.06mm] CONTINUOUS ALUMINUM ANGLE ● PERIMETER JAMBS (SHIP-LOOSE)

.081 [2.1mm] EXTRUDED ALUMINUM JAMB SEALANT AND BACKER ROD NOT BY GREENHECK

1/8" [3.2mm]

1/4" [6.4mm]

1/4" [6.4mm] ALUMINUM MULLION SUPPORT ANGLE. (IF REQ'D) DEPTH VARIES (2" [50.8mm], 4" [101.6mm] OR 6" [152.4mm])

3" X 3" X 1/4" [6.4mm] ALUMINUM MULLION ANCHOR CLIP 12" [304.8mm] LONG. AT HEAD AND SILL (IF REQ'D)

SEALANT AND BACKER ROD NOT BY GREENHECK

VARIABLE MINIMUM 1/2" [12.7mm]

SECTION WIDTH

SECTION WIDTH

1/4" [6.4mm]

SILL PAN

LOUVER WIDTH

OPENING WIDTH

C JAMB DETAIL

D MULLION DETAIL

3" X 3" X 1/4" [6.4mm] ALUMINUM MULLION ANCHOR CLIP 12" [304.8mm] LONG. AT HEAD AND SILL (IF REQ'D)

36" [914.4mm] LONG EXTRUDED ALUMINUM SPLICE ANGLE - IF REQ'D (REFER DETAIL F)

1 1/2" X 1 1/2" X 1/8" [3.2mm] EXTRUDED ALUMINUM SUPPORT ANGLE

SILL PAN

LOUVER WIDTH

OPENING WIDTH

E SUPPORT DETAIL

OPTION DRAWINGS

EHH-501X

Florida Product Approval No: FL6876.2,15718.2
UL Classified: R25119

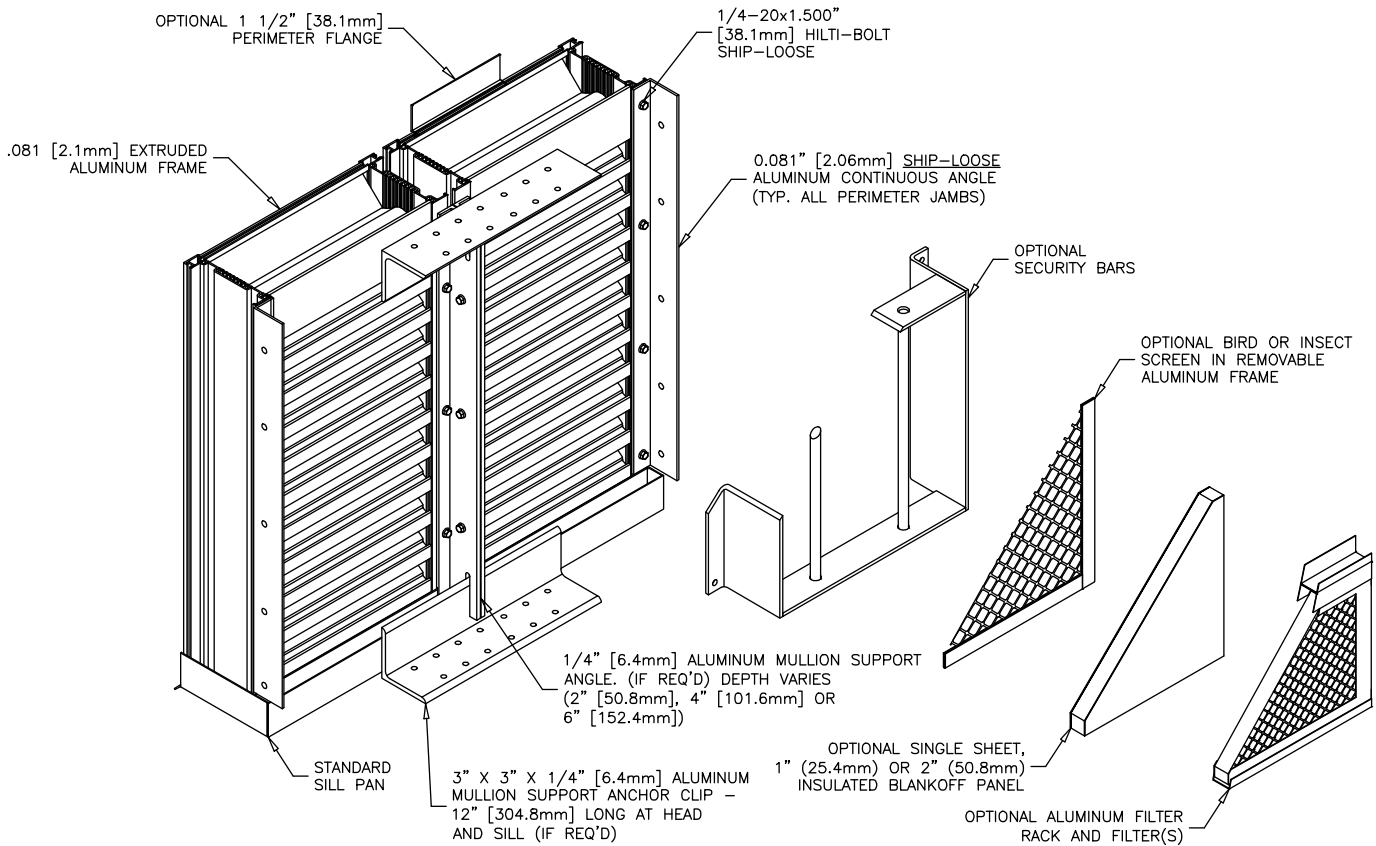

FINISHES

Finish Type	Description/Application	Color Selection	Standard Warranty (Aluminum)
AAMA 2605 100% Fluoropolymer (FEVE) 2-Coat 70% Kynar® (PVDF) 3-Coat 70% Kynar® (PVDF) 4-Coat 70% Kynar® (PVDF)	"Best." The premier finish for extruded aluminum. Tough, long-lasting coating has superior color retention and abrasive properties. Resists chalking, fading, chemical abrasion and weathering.	Standard Colors: Any of the 27 standard colors shown can be furnished in 70% or 50% Kynar®, 100% Fluoropolymer or Baked Enamel.	10 Years (20 Years Optional)
AAMA 2604 50% Kynar® / Acroflur®	"Better." Tough, long-lasting coating has excellent color retention and abrasive properties. Resists chalking, fading, chemical abrasion and weathering.	Mica Colors: Greenheck offers 6 standard Mica colors for 70% Kynar® or 100% Fluoropolymer.	5 Years
AAMA 2603 Baked Enamel	"Good." Provides good adhesion and resistance to weathering, corrosion and chemical stain.	Custom Colors: Custom color matching is available. Consult your Greenheck representative for cost and/or lead-time implications if a custom color is required.	1 Year
AA-M10C22A42 Integral Color Anodize	"Two-step" anodizing is produced by following the normal anodizing step with a second, colorfast process.	Light, Medium, Dark or Extra Dark Bronze; Champagne; Black	5 years
AA-M10C22A41 Clear Anodize 215 R-1	Clear, colorless and hard oxide aluminum coating that resists weathering and chemical attack.	Clear	5 years
AA-M10C22A31 Clear Anodize 204	Clear, colorless and hard oxide aluminum coating that resists weathering and chemical attack.	Clear	1 Year
Prime Coat	Louvers or architectural products shall be cleaned, pre-treated and receive a prime coat finish suitable for field painting. Greenheck does not recommend prime coat or field painting of materials.		n/a
Mill	Materials may be supplied in natural aluminum or galvanized steel finish when normal weathering is acceptable and there is no concern for color or color change.		n/a

Finishes meet or exceed AAMA 2605, AAMA 2604, and AAMA 2603 requirements. Please consult www.greenheck.com for complete information on standard and extended paint warranties. Paint finish warranties are not applicable to steel products.



EHH-501X
February 2020

Copyright © 2020 Greenheck Fan Corporation

Greenheck Fan Corporation reserves the right to make product changes without notice.