

Vane Axial Flow Fans

- Direct Driven
- Belt Driven



Dongguan Wolter Chemco Ventilation Ltd. certifies that the series AXV-F shown herein are licensed to bear the AMCA Seal. The ratings shown are based on tests and procedures performed in accordance with AMCA Publication 211 and AMCA Publication 311 and comply with the requirements of the AMCA Certified Ratings Program.

Air in Motion.
Wolter Fans.

A09-F



Table of Content



Content.....	1
Technical Information.....	2~4
Fan Type Code.....	2
Design Features.....	2
Types and Duty Range.....	2
Application.....	2
Casing.....	2
Impellers.....	2
Motor.....	2
Fan Performance Curves.....	2
Sound Levels.....	2
Belt Driven Design.....	2
Ordering Designations.....	2
Fan Selection and Installation.....	3
Forms of Running.....	3
Selection Example.....	4
Fan Efficiency Grade - 50Hz.....	5
Performance Curve - 50Hz.....	6~23
Fan Efficiency Grade - 60Hz.....	24
Performance Curve - 60Hz.....	25~42
Dimension.....	43~46
Sound Information.....	47~51

Subject to change without prior notice.

Vane Axial Fans

Technical information

AXV-F

Fan type code

AXV-F 1400 / 20°

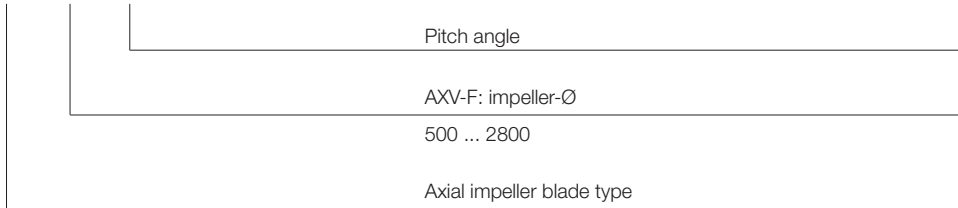

Design features

Types and duty range

Wolter vane axial high pressure fans can be used for various applications in ventilation and process air technology. Standard diameters range from 500 to 2,800 mm, with airflow rates of up to 260 m³/s at static pressure increases of up to 2,500 Pa. The high efficiencies and high pressures are achieved by the use of the aerodynamically designed guide vanes.

Application

The AXV-F range of vane axial fans is designed, tested and certified to operate at standard temperatures as well as at elevated temperatures of maximum up to 600deg/C for 240 minutes inclusive of F600 (600deg/120mins), F400 (400deg/120mins) and F300 (300deg/60mins) according to EN 12101-3:2015. The following fan curves are valid for standard temperatures and 300°/60(120) minutes operation. To select a fan for 400°C/120 minutes and 600°C/240 minutes operation, please contact our technical support. For F600, fans come in bifurcated and belt driven configuration with motor out of air flow.

Well suited for industrial applications, ventilation, smoke exhaust, stair case pressurisation and for conveying clean and dusty air where medium to high pressures are required with high airflow volume and fan efficiency.

Casing

Fans are made of steel, with flanges rolled on both sides. The pitch circles of holes are in accordance with DIN 24 154, R2. The fan casings are hot dipped galvanised as standard. Optional: Optimal corrosion protection by powder-coating.

If motors require additional lubrication, tubes and grease-nipples are fitted to the outside of the fan casing. An inspection hole, closed by a rubber plug, allows controlling the direction of rotation.

Impellers

Hubs and impeller blades are made of highly corrosion resistant pressure-cast aluminium alloy. Optional: Hub and aerofoil profiled blades made of steel for F600. The aero dynamical profile of the impeller blades guarantees a high level of efficiency and low noise. The blade angle is adjustable during standstill. The variable number of blades expands the performance range. Dynamically balanced according to DIN ISO 1940-1, balancing quality G6.3.

Motors

Wolter uses closed squirrel cage motors according to IEC 34, if required also in accordance with EPACT. Standard motors are class F with IP 55 protection class. Multi speed versions with 2 or 3 speeds (Dahlander circuit or separate windings) are also available, as well as explosion-proof versions or specific industrial executions such as marine-type fans. The motor bearings have a L 10 life. For high temperature applications, three phase motor according to EN 12101-3 in protection class IP55, insulation class H.

Fan performance curves

The performance curves for size 500 to 1250 have been established in installation type - D (according to AMCA 210, ducted inlet and ducted outlet) while installation type A (free inlet and free outlet) is for size 1400 to 2800 and represent the total pressure increase Δp , as a function of the volume flow. The dynamic pressure p_{a2} refers to the outlet area of the fan.

Sound levels

The ascertaining of sound level follows the Reverberant Room Method according to AMCA 300. The A-weighted inlet sound power levels L_{wIA} or outlet sound power levels L_{wOA} are shown on the performance curves.

Belt driven design

Belt driven fan with single / dual motors can be mounted in various positions to suit the actual site condition. Belt driven fans are used for applications to extract more heavily polluted air i.e. presence of corrosive or hazardous fumes, or dirt-laden, moist air or hot air. Various mounting positions are illustrated.

Ordering designations

When ordering, please provide the following information:

- ▶ Fan type
- ▶ Fan code and type
- ▶ Quantity required
- ▶ Duty required at standard air and temperature (air volume in m³/h at static pressure in Pa).
- ▶ Motor power rating in kW
- ▶ Electrical supply
- ▶ Ancillaries required

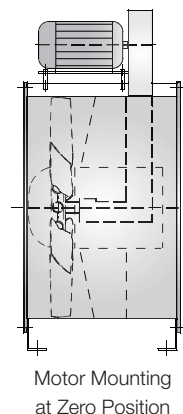
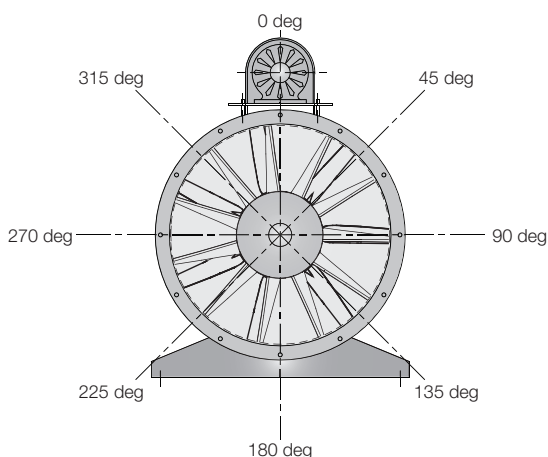

Motor Mounting Position - Specify in degree



AXV-F

Fan selection and installation

Fan selection

Please select fans according to the nearest performance curve above the required duty point. The middle range of each fan curve is the area of highest efficiency. Do not select fans at the upper end of the fan curve, as this might cause the fan to work in stall. In order to avoid motor overloading, please select motors according to the peak power of the respective performance curve. Please refer to the selection example on the following page.

Fan installation

When installing the fan, please consider the following instructions:

► Fans with free inlet and outlet should be installed with an unobstructed distance of at least 1,5 x fan diameter on suction and pressure sides. Fans should have a bellmouth on the inlet side in order to assure optimal incoming flow. A diffusor mounted on the pressure side will increase efficiency.

► When installing fans in a ducted system, adequate distance to other structural parts such as bends, filters and silencers should be provided for. A sharp bend radius of the duct near the suction or pressure side of the fan is to be avoided. Flexible connections are to be installed in a way that does not obstruct the outlet cross section of the fan (see following page).

Forms of running

Wolter axial flow fans are available for all forms of running. The chart below shows all standard forms of running. Please indicate the required configuration when ordering. Arrows outside the fan casing indicates the correct direction of rotation and airflow.

Form S, SU and SO are not licensed by AMCA International.

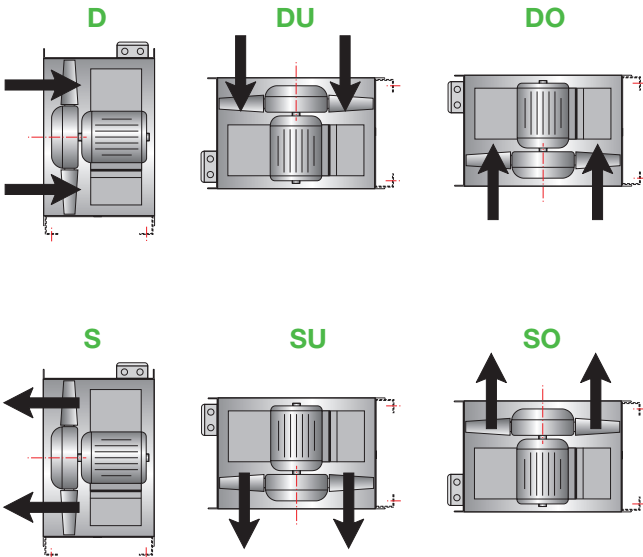
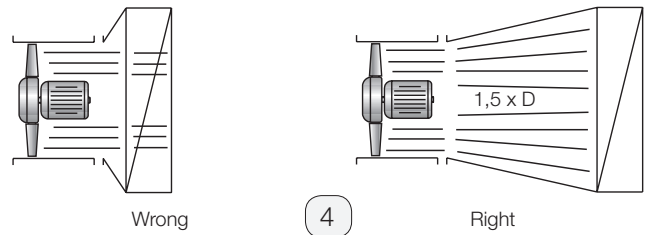
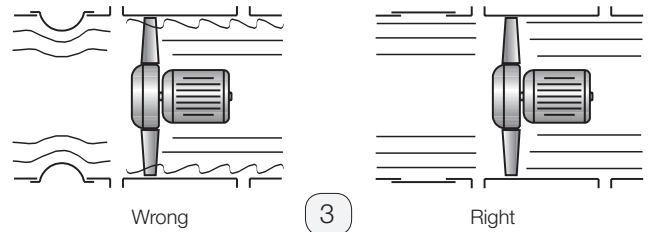
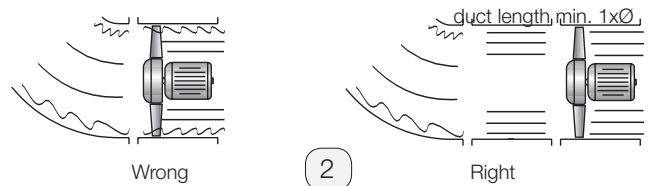
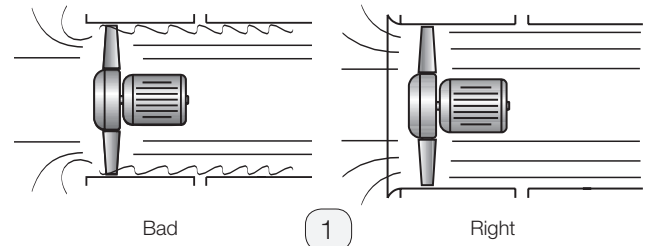

Selection example

Required duty point

- Volume flow: 50000 m³/h
- Static pressure: 735 Pa

In order to calculate the total pressure, please add velocity pressure to static pressure (185 Pa dynamic pressure + 735 Pa static pressure = 920 Pa total pressure)

- Fan speed: 1.500 1/min (4-pole)

Using the fan curve

Having chosen a fan with adequate performance range for the required duty point, plot volume flow and pressure.

At the point of intersection, the following data can be read:

- Motor speed or number of poles 1.500 1/min - 4-pole
- Pitch angle: 30 degrees
- Absorbed power: 19,30 kW
- Sound Power Level: 114 dBA

Calculation of motor power

There are two possibilities to calculate the motor power:

- Calculation of absorbed power by using the fan curve in duty point: 19,30 kW

Motor power: 22 kW

- Calculation according to peak absorbed power, see table below the fan curve: 19,49 kW

Motor power: 22 kW

The given peak absorbed power is the maximum shaft absorbed power over the whole pitch angle curve in.

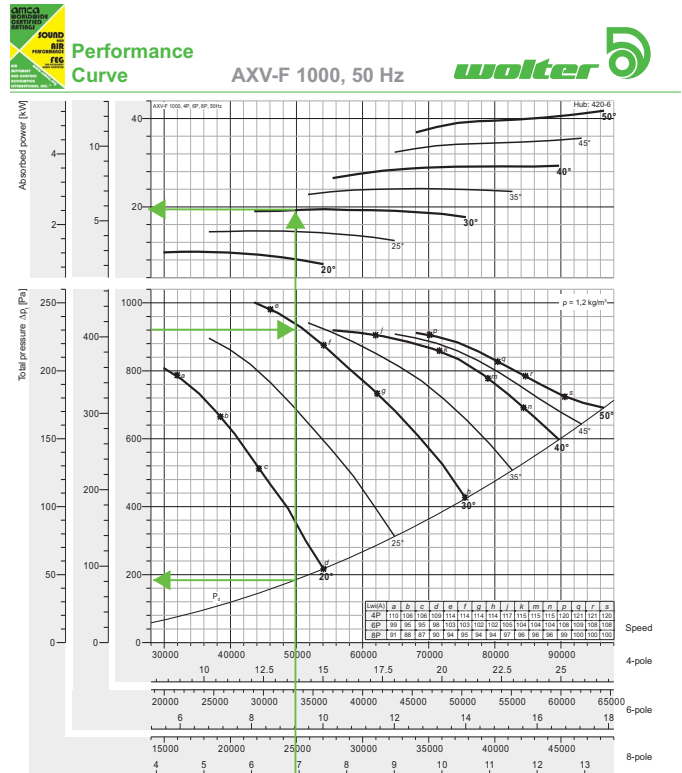

N Poles	Pitch angle [°]						
	20	25	30	35	40	45	50
4P motor	9,853	14,61	19,49	24,16	29,32	35,55	41,77
6P motor	2,919	4,330	5,776	7,159	8,688	10,53	12,38
8P motor	3	5,5	7,5	11			15

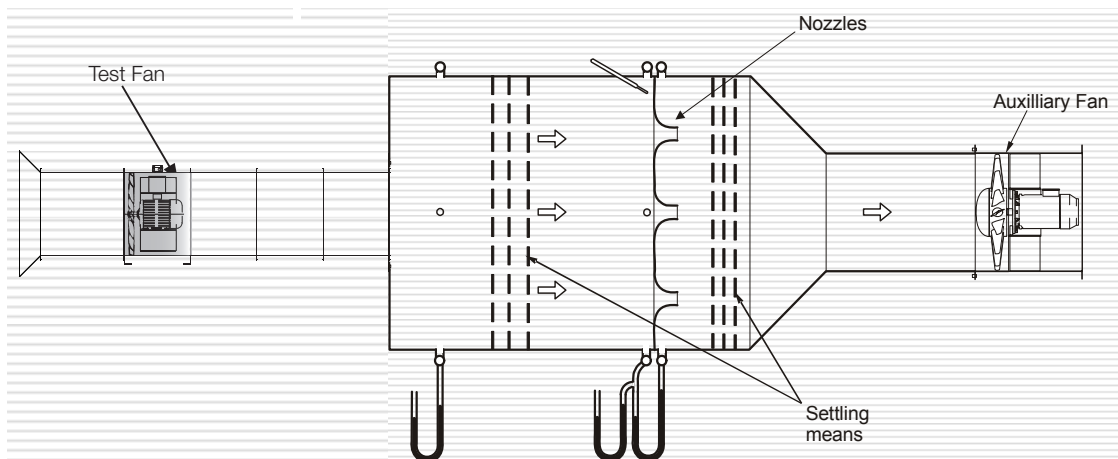

AMCA 210 Figure 12
ISO 5801 Figure 73b

AMCA - FEG rating

Fan Efficiency Grade: AXV-F



Certified FEGs are determined in accordance with AMCA 205-12 Energy Efficiency Classification for fans. In conjunction with AMCA 211-13 (Rev. 2015) Certified Ratings Program, Product Rating Manual for Fan Air Performance. This classification is based on fan peak (optimum) total efficiency for a given fan speed, fan size and application category. For the purpose of energy classification, the peak efficiency can be determined at a speed not higher than the maximum design speed of the fan.

The AMCA Certified Ratings Seal applies to the Fan Efficiency Grade (FEG) for AXV-F series Axial Fan model AXV-F 500 to AXV-F 2800 as shown in the table below.

Fan Model No.	Fan Speed (rpm)	Fan Outlet Area (m2)	Fan Efficiency Grades	Fan Model No.	Fan Speed (rpm)	Fan Outlet Area (m2)	Fan Efficiency Grade
AXV-F 500	3000/1500/1000	0,1987	FEG 80	AXV-F 1400	1500/1000/750	1,5504	FEG 80
AXV-F 560	3000/1500/1000	0,2507	FEG 75	AXV-F 1600	1500/1000/750	2,0232	FEG 80
AXV-F 630	3000/1500/1000	0,3157	FEG 75	AXV-F 1800	1000/750/600	2,5588	FEG 80
AXV-F 710	3000/1500/1000	0,3970	FEG 75	AXV-F 2000	1000/750/600	3,1573	FEG 80
AXV-F 800	1500/1000/750	0,4989	FEG 75	AXV-F 2200	750/600/500	3,8186	FEG 80
AXV-F 900	1500/1000/750	0,6277	FEG 75	AXV-F 2400	750/600/500	4,5428	FEG 80
AXV-F 1000	1500/1000/750	0,7901	FEG 75	AXV-F 2500	750/600/500	4,9284	FEG 80
AXV-F 1120	1500/1000/750	0,9940	FEG 75	AXV-F 2600	750/600/500	5,3297	FEG 80
AXV-F 1250	1500/1000/750	1,2272	FEG 75	AXV-F 2800	750/600/500	6,1795	FEG 80

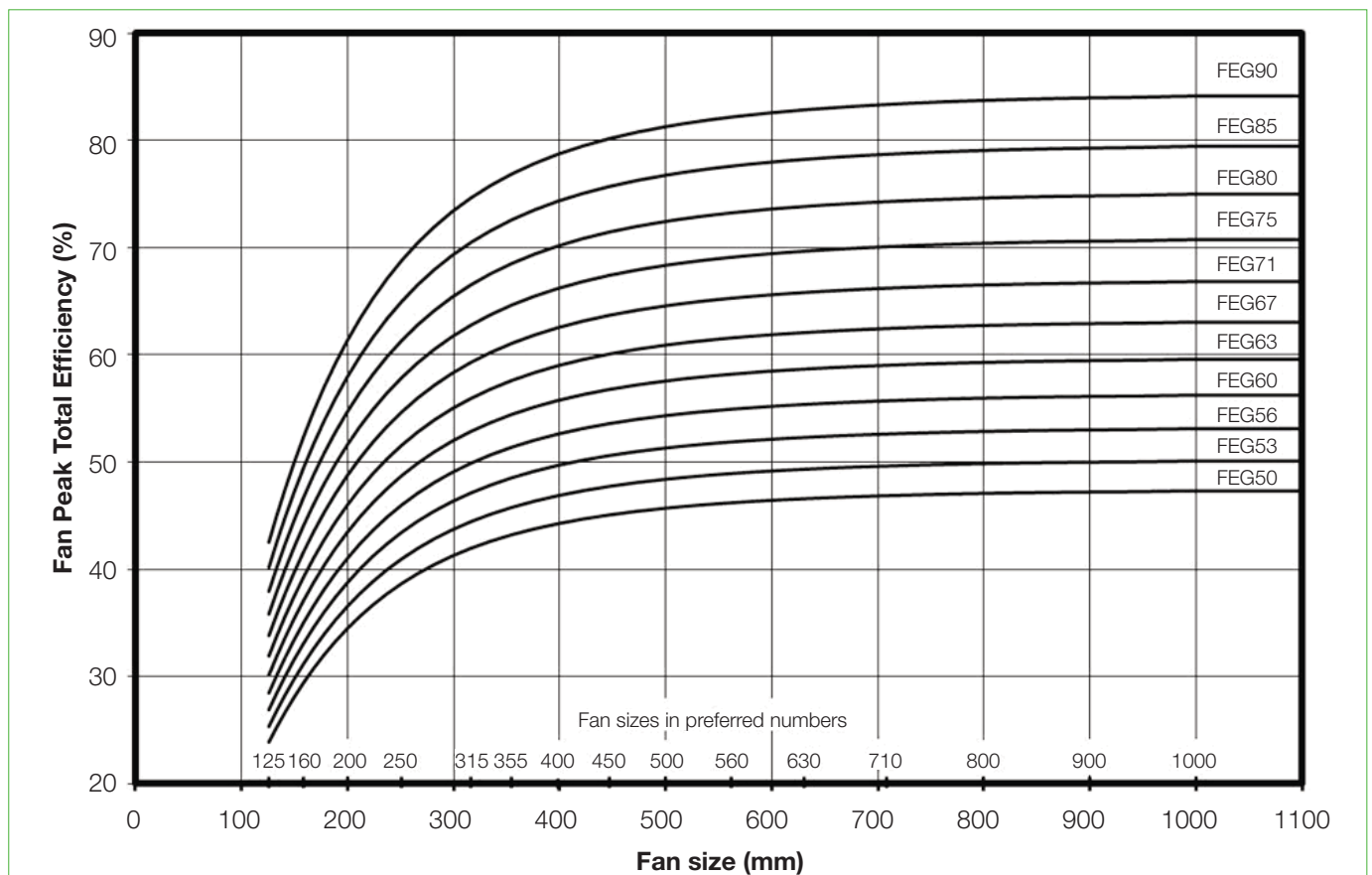



Performance Curve

AXV-F 500, 50 Hz

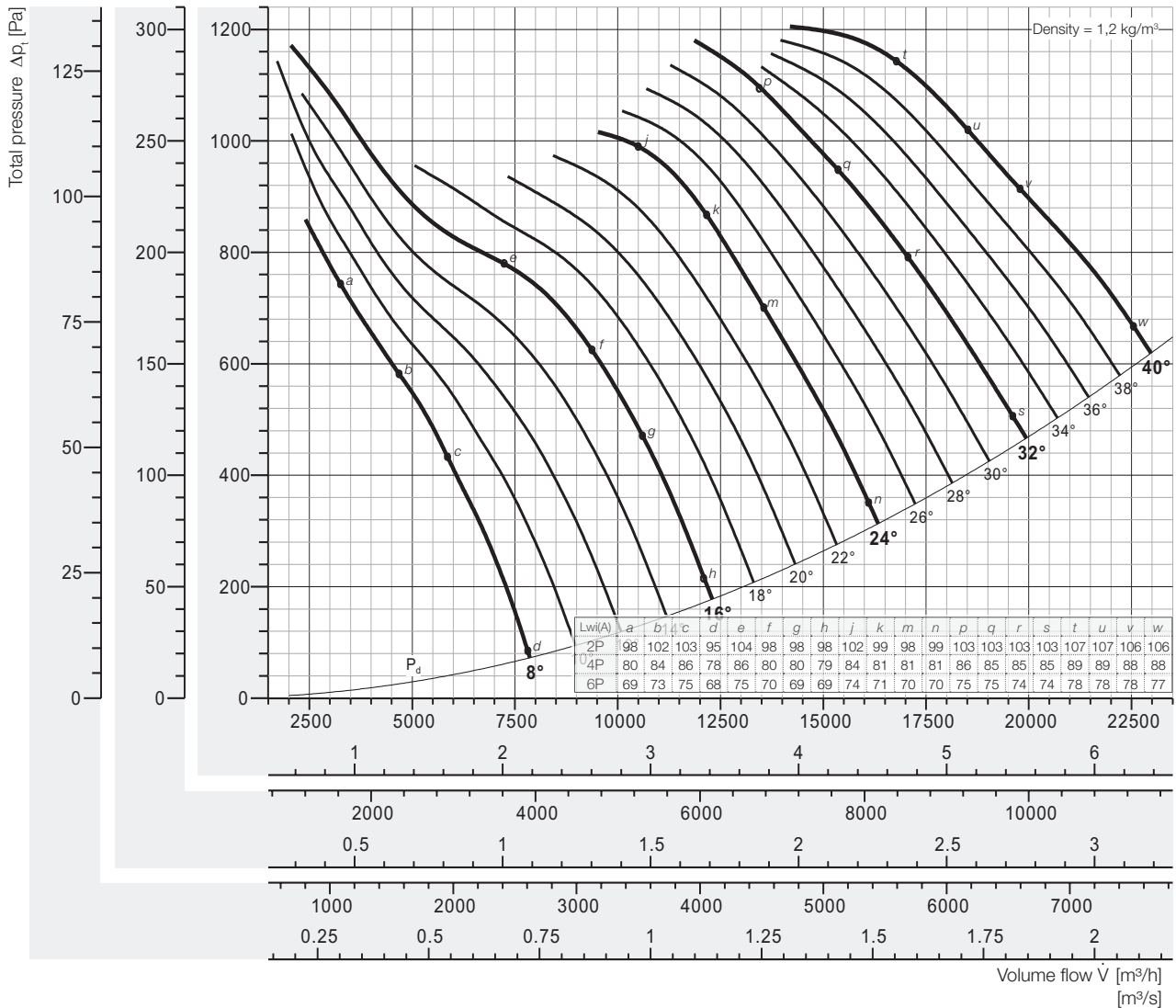
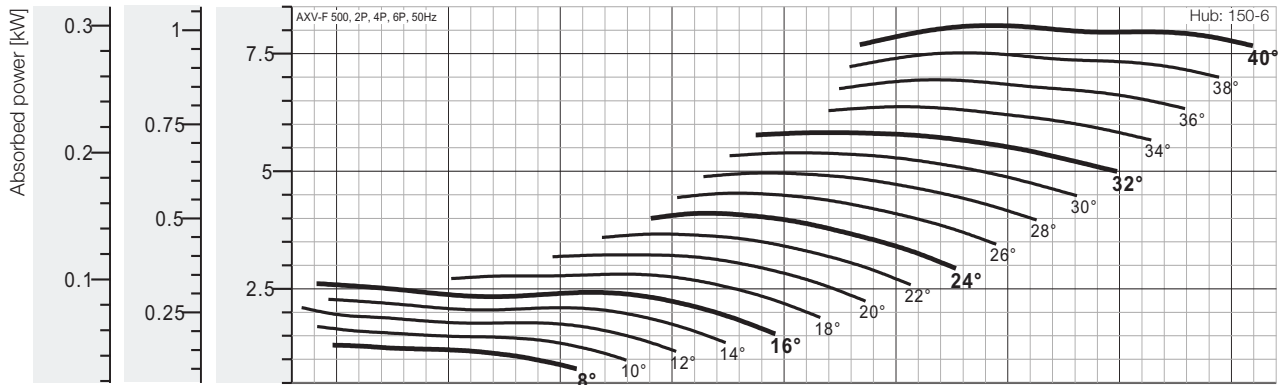

Speed
2-pole
4-pole
6-pole

Peak absorbed power [kW]

2-pole = 3000 rpm; 4-pole = 1500 rpm; 6-pole = 1000 rpm;

N Poles	Pitch angle [°]																
	8	10	12	14	16	18	20	22	24	26	28	30	32	34	36	38	40
2P motor	1,302	1,703	2,103	2,278	2,610	2,812	3,224	3,665	4,108	4,536	4,965	5,395	5,825	6,372	6,946	7,522	8,100
4P motor	0,163	0,213	0,263	0,285	0,326	0,352	0,403	0,458	0,514	0,567	0,621	0,674	0,728	0,797	0,868	0,940	1,012
6P motor	0,048	0,063	0,078	0,084	0,097	0,104	0,119	0,136	0,152	0,168	0,184	0,200	0,216	0,236	0,257	0,279	0,300

Fan test laboratory AMCA 210/99 Fig.12, Test Chamber. Performance certified is for installation type D - Ducted inlet, Ducted outlet. Performance ratings do not include the effects of appurtenances (accessories-belt cover, pulley & belt). Power rating (kW) does not include transmission losses.

The A-weighted sound ratings shown have been calculated per AMCA International Standard 301. Values shown are for inlet Lw(A) sound power levels for installation Type D: ducted inlet, ducted outlet. Ratings include the effects of duct end correction.

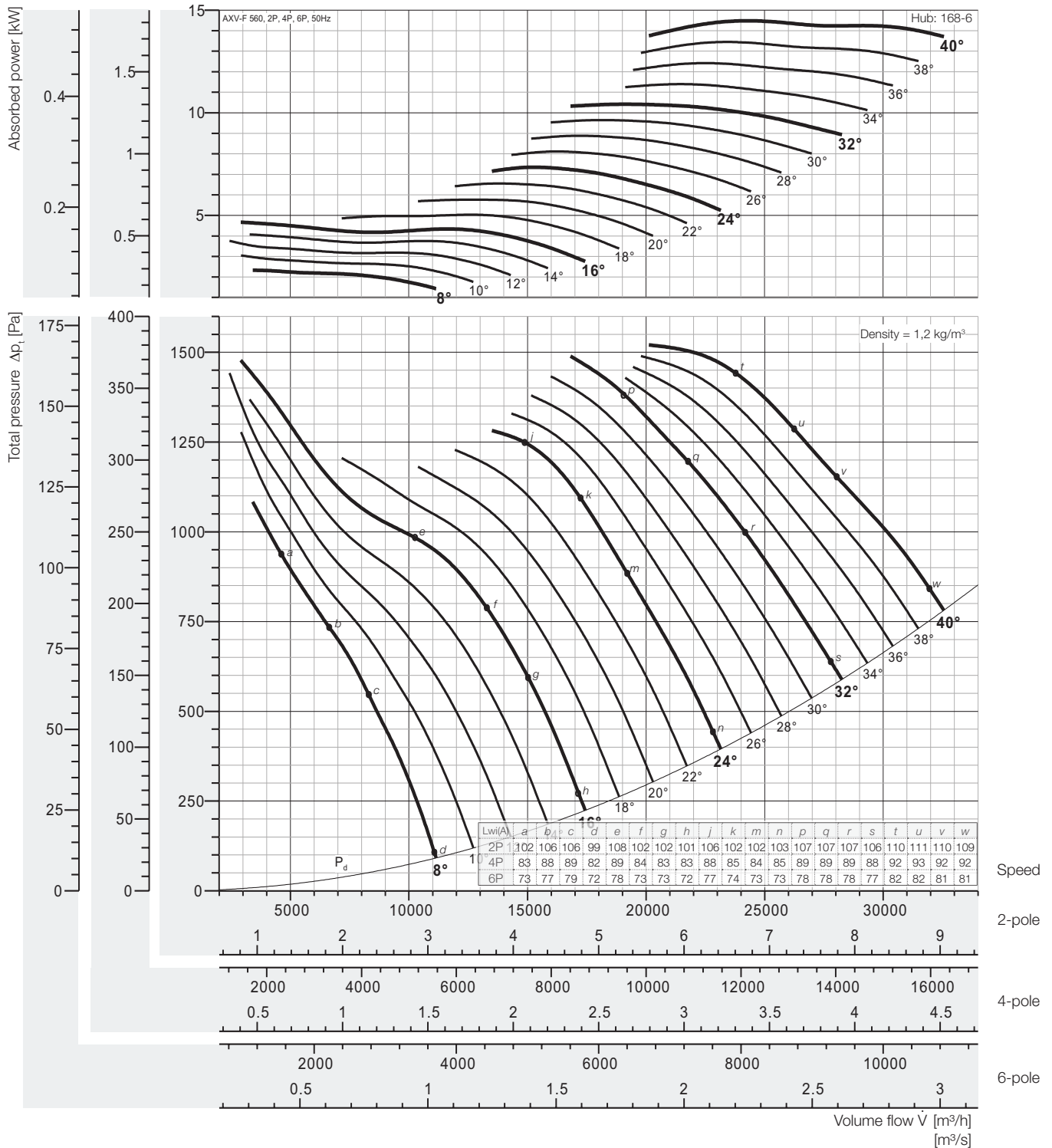

Peak absorbed power [kW]

2-pole = 3000 rpm; 4-pole = 1500 rpm; 6-pole = 1000 rpm;

N Poles	Pitch angle [°]																			
	8	10	12	14	16	18	20	22	24	26	28	30	32	34	36	38	40			
2P motor	2,329	3,045	3,761	4,073	4,667	5,028	5,765	6,553	7,345	8,111	8,878	9,646	10,42	11,39	12,42	13,45	14,48			
4P motor	0,291	0,381	0,470	0,509	0,583	0,629	0,721	0,819	0,918	1,014	1,110	1,206	1,302	1,424	1,552	1,681	1,810			
6P motor	0,086	0,113	0,139	0,151	0,173	0,186	0,214	0,243	0,272	0,300	0,329	0,357	0,386	0,422	0,460	0,498	0,536			

Fan test laboratory AMCA 210/99 Fig.12, Test Chamber. Performance certified is for installation type D - Ducted inlet, Ducted outlet. Performance ratings do not include the effects of appurtenances (accessories-belt cover, pulley & belt). Power rating (kW) does not include transmission losses.

The A-weighted sound ratings shown have been calculated per AMCA International Standard 301. Values shown are for inlet Lw(A) sound power levels for installation Type D: ducted inlet, ducted outlet. Ratings include the effects of duct end correction.



Performance Curve

AXV-F 630, 50 Hz

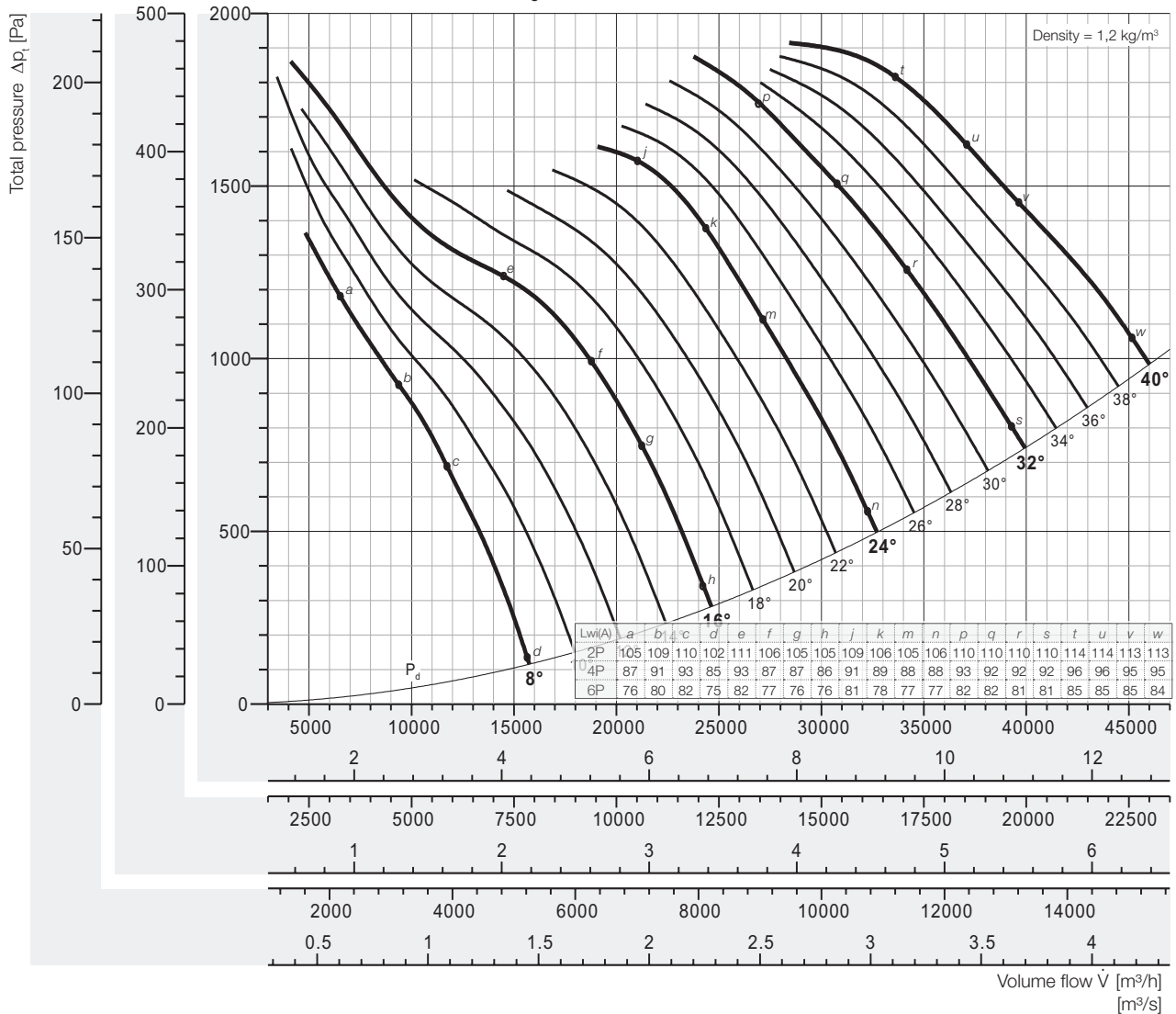
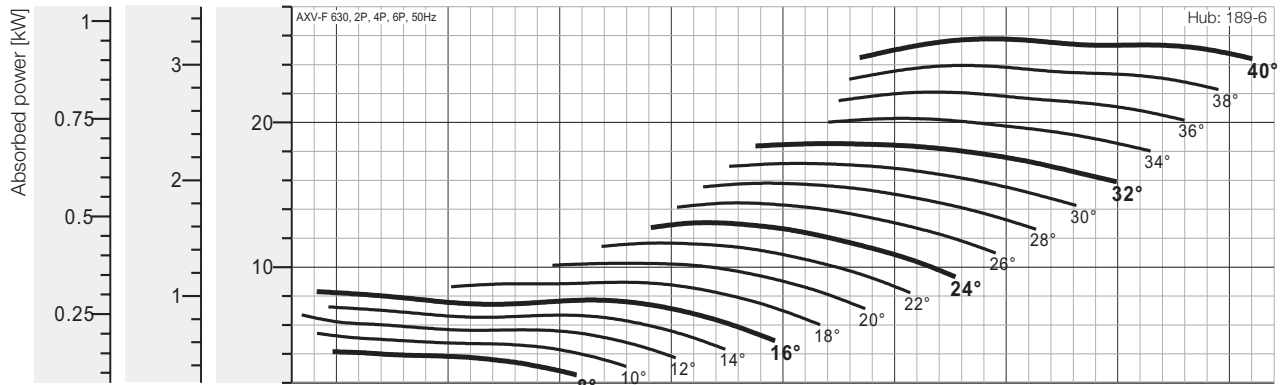

Speed
2-pole
4-pole
6-pole

Peak absorbed power [kW]

2-pole = 3000 rpm; 4-pole = 1500 rpm; 6-pole = 1000 rpm;

N Poles	Pitch angle [°]																			
	8	10	12	14	16	18	20	22	24	26	28	30	32	34	36	38	40			
2P motor	4,145	5,419	6,693	7,248	8,307	8,949	10,26	11,66	13,07	14,44	15,80	17,17	18,54	20,28	22,10	23,94	25,78			
4P motor	0,518	0,677	0,837	0,906	1,038	1,119	1,283	1,458	1,634	1,805	1,975	2,146	2,317	2,535	2,763	2,992	3,222			
6P motor	0,154	0,201	0,248	0,268	0,308	0,331	0,380	0,432	0,484	0,535	0,585	0,636	0,687	0,751	0,819	0,887	0,955			

Fan test laboratory AMCA 210/99 Fig.12, Test Chamber. Performance certified is for installation type D - Ducted inlet, Ducted outlet. Performance ratings do not include the effects of appurtenances (accessories-belt cover, pulley & belt). Power rating (kW) does not include transmission losses.

The A-weighted sound ratings shown have been calculated per AMCA International Standard 301. Values shown are for inlet Lw(A) sound power levels for installation Type D: ducted inlet, ducted outlet. Ratings include the effects of duct end correction.

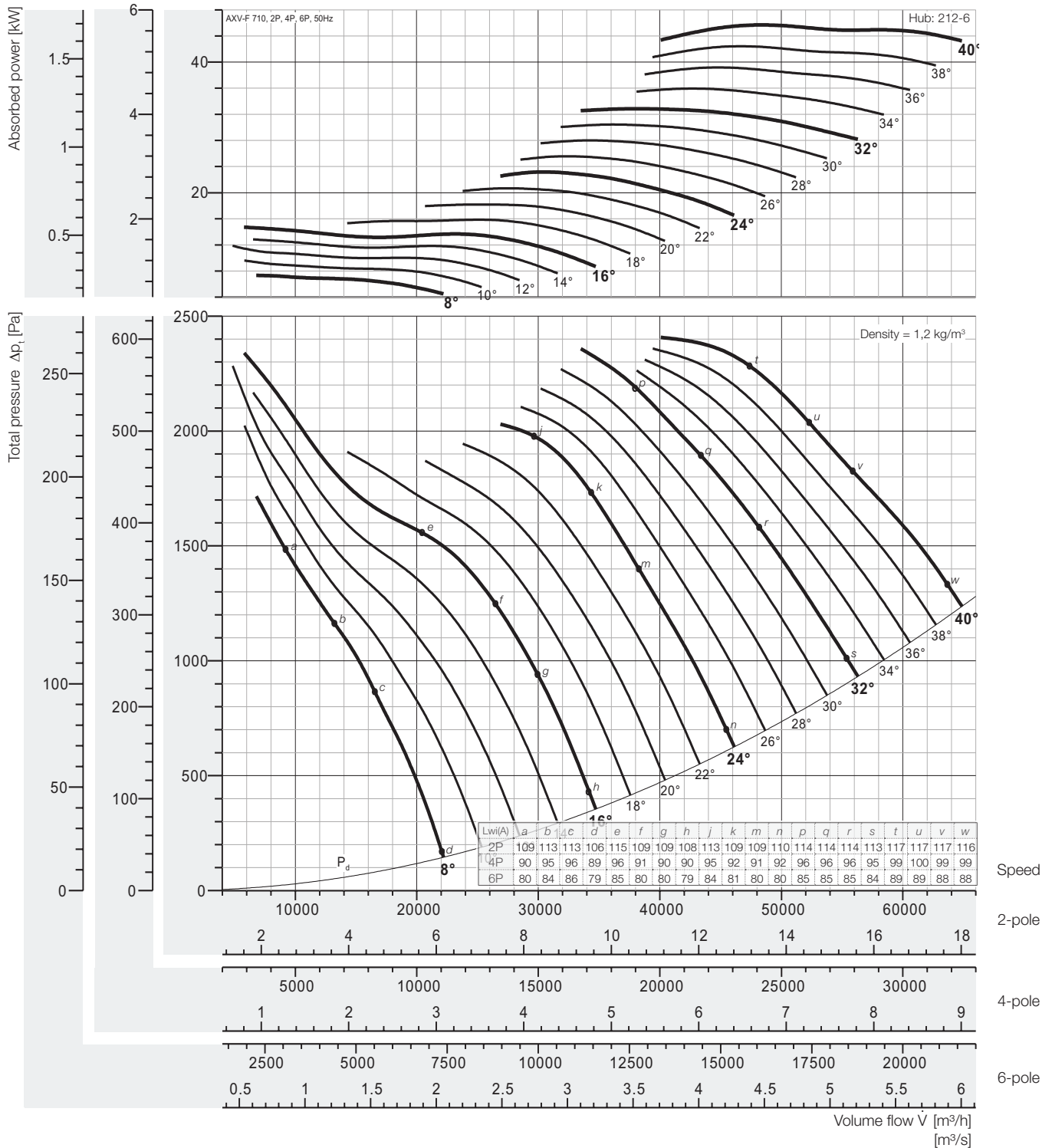

Peak absorbed power [kW]

2-pole = 3000 rpm; 4-pole = 1500 rpm; 6-pole = 1000 rpm;

N Poles	Pitch angle [°]																
	8	10	12	14	16	18	20	22	24	26	28	30	32	34	36	38	40
2P motor	7,347	9,606	11,86	12,85	14,73	15,86	18,19	20,67	23,17	25,59	28,01	30,43	32,86	35,95	39,18	42,43	45,69
4P motor	0,918	1,201	1,483	1,606	1,841	1,983	2,274	2,584	2,897	3,199	3,501	3,804	4,107	4,494	4,898	5,304	5,711
6P motor	0,272	0,356	0,439	0,476	0,545	0,588	0,674	0,766	0,858	0,948	1,037	1,127	1,217	1,331	1,451	1,572	1,692

Fan test laboratory AMCA 210/99 Fig.12, Test Chamber. Performance certified is for installation type D - Ducted inlet, Ducted outlet. Performance ratings do not include the effects of appurtenances (accessories-belt cover, pulley & belt). Power rating (kW) does not include transmission losses.

The A-weighted sound ratings shown have been calculated per AMCA International Standard 301. Values shown are for inlet LwiA sound power levels for installation Type D: ducted inlet, ducted outlet. Ratings include the effects of duct end correction.



Performance Curve

AXV-F 800, 50 Hz

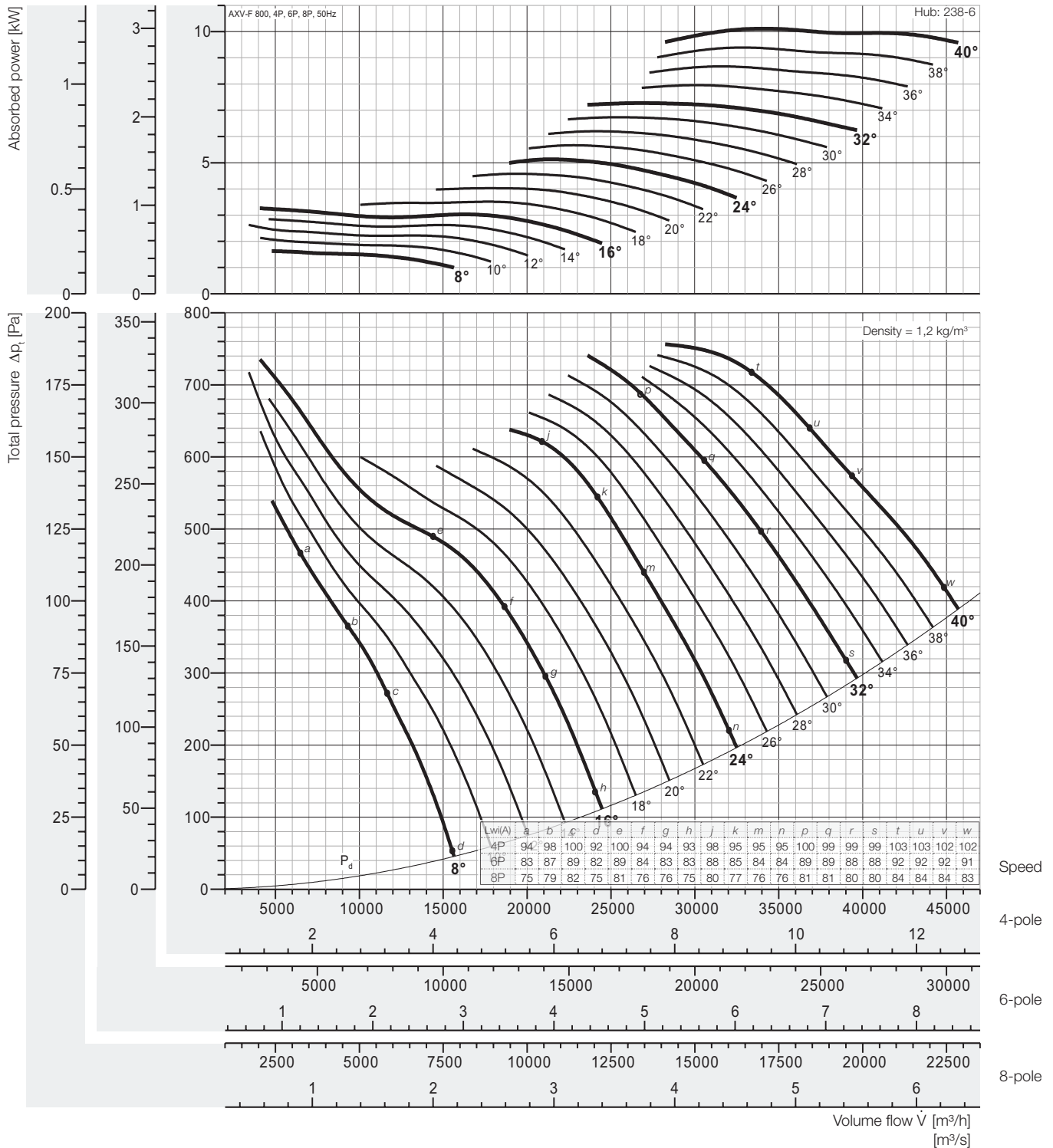

Peak absorbed power [kW]

4-pole = 1500 rpm; 6-pole = 1000 rpm; 8-pole = 750 rpm;

N Poles	Pitch angle [°]																
	8	10	12	14	16	18	20	22	24	26	28	30	32	34	36	38	40
4P motor	1,626	2,126	2,626	2,844	3,260	3,512	4,026	4,576	5,130	5,665	6,200	6,737	7,274	7,957	8,673	9,393	10,11
6P motor	0,482	0,630	0,778	0,843	0,966	1,040	1,193	1,356	1,520	1,678	1,837	1,996	2,155	2,358	2,570	2,783	2,997
8P motor	0,203	0,266	0,328	0,356	0,407	0,439	0,503	0,572	0,641	0,708	0,775	0,842	0,909	0,995	1,084	1,174	1,264

Fan test laboratory AMCA 210/99 Fig.12, Test Chamber. Performance certified is for installation type D - Ducted inlet, Ducted outlet. Performance ratings do not include the effects of appurtenances (accessories-belt cover, pulley & belt). Power rating (kW) does not include transmission losses.

The A-weighted sound ratings shown have been calculated per AMCA International Standard 301. Values shown are for inlet Lw(A) sound power levels for installation Type D: ducted inlet, ducted outlet. Ratings include the effects of duct end correction.

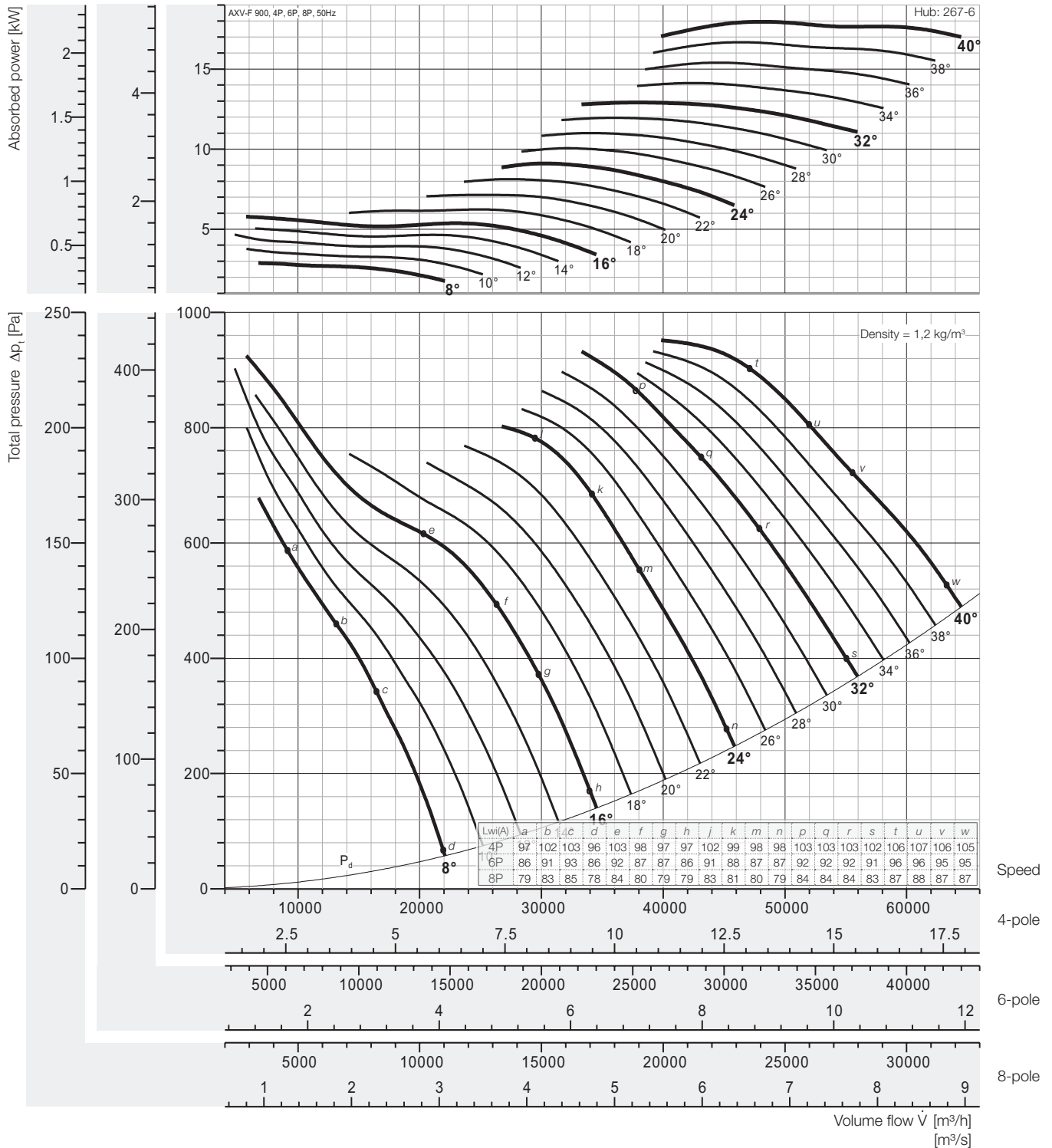

Peak absorbed power [kW]

4-pole = 1500 rpm; 6-pole = 1000 rpm; 8-pole = 750 rpm;

N Poles	Pitch angle [°]																			
	8	10	12	14	16	18	20	22	24	26	28	30	32	34	36	38	40			
4P motor	2,888	3,775	4,663	5,050	5,787	6,235	7,149	8,125	9,108	10,06	11,00	11,96	12,91	14,13	15,40	16,68	17,96			
6P motor	0,856	1,119	1,382	1,496	1,715	1,847	2,118	2,407	2,699	2,980	3,262	3,544	3,826	4,186	4,563	4,941	5,321			
8P motor	0,361	0,472	0,583	0,631	0,723	0,779	0,894	1,016	1,138	1,257	1,376	1,495	1,614	1,766	1,925	2,085	2,245			

Fan test laboratory AMCA 210/99 Fig.12, Test Chamber. Performance certified is for installation type D - Ducted inlet, Ducted outlet. Performance ratings do not include the effects of appurtenances (accessories-belt cover, pulley & belt). Power rating (kW) does not include transmission losses.

The A-weighted sound ratings shown have been calculated per AMCA International Standard 301. Values shown are for inlet Lw(A) sound power levels for installation Type D: ducted inlet, ducted outlet. Ratings include the effects of duct end correction.



Performance Curve

AXV-F 1000, 50 Hz

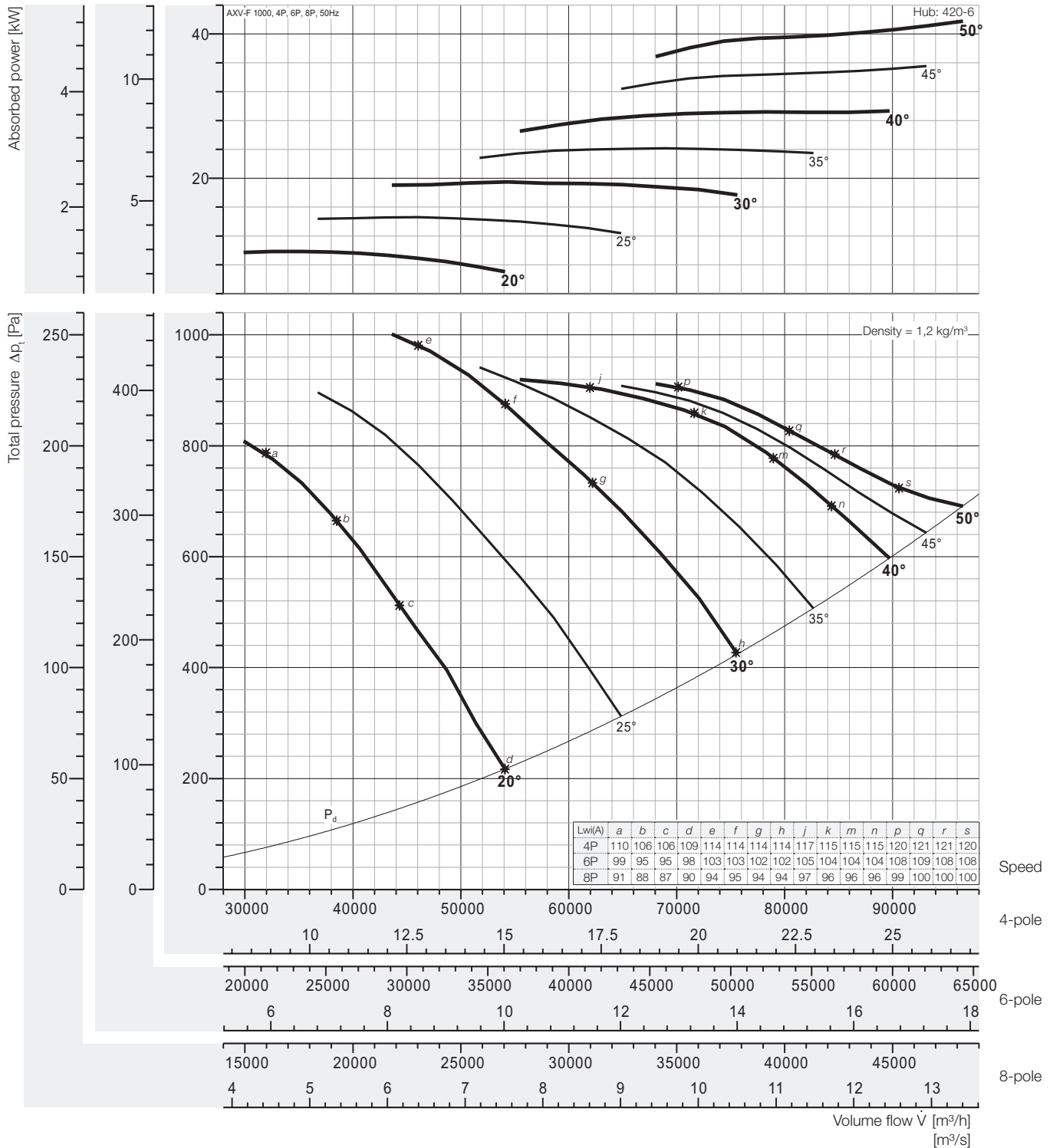

Peak absorbed power [kW]

4-pole = 1500 rpm; 6-pole = 1000 rpm; 8-pole = 750 rpm;

N Poles	Pitch angle [°]						
	20	25	30	35	40	45	50
4P motor	9,853	14,61	19,49	24,16	29,32	35,55	41,77
6P motor	2,919	4,330	5,776	7,159	8,688	10,53	12,38
8P motor	1,232	1,827	2,437	3,020	3,665	4,443	5,222

Fan test laboratory AMCA 210/99 Fig.12, Test Chamber. Performance certified is for installation type D - Ducted inlet, Ducted outlet. Performance ratings do not include the effects of appurtenances (accessories-belt cover, pulley & belt). Power rating (kW) does not include transmission losses.

The A-weighted sound ratings shown have been calculated per AMCA International Standard 301. Values shown are for inlet Lw(A) sound power levels for installation Type D: ducted inlet, ducted outlet. Ratings include the effects of duct end correction.



Performance Curve

AXV-F 1120, 50 Hz

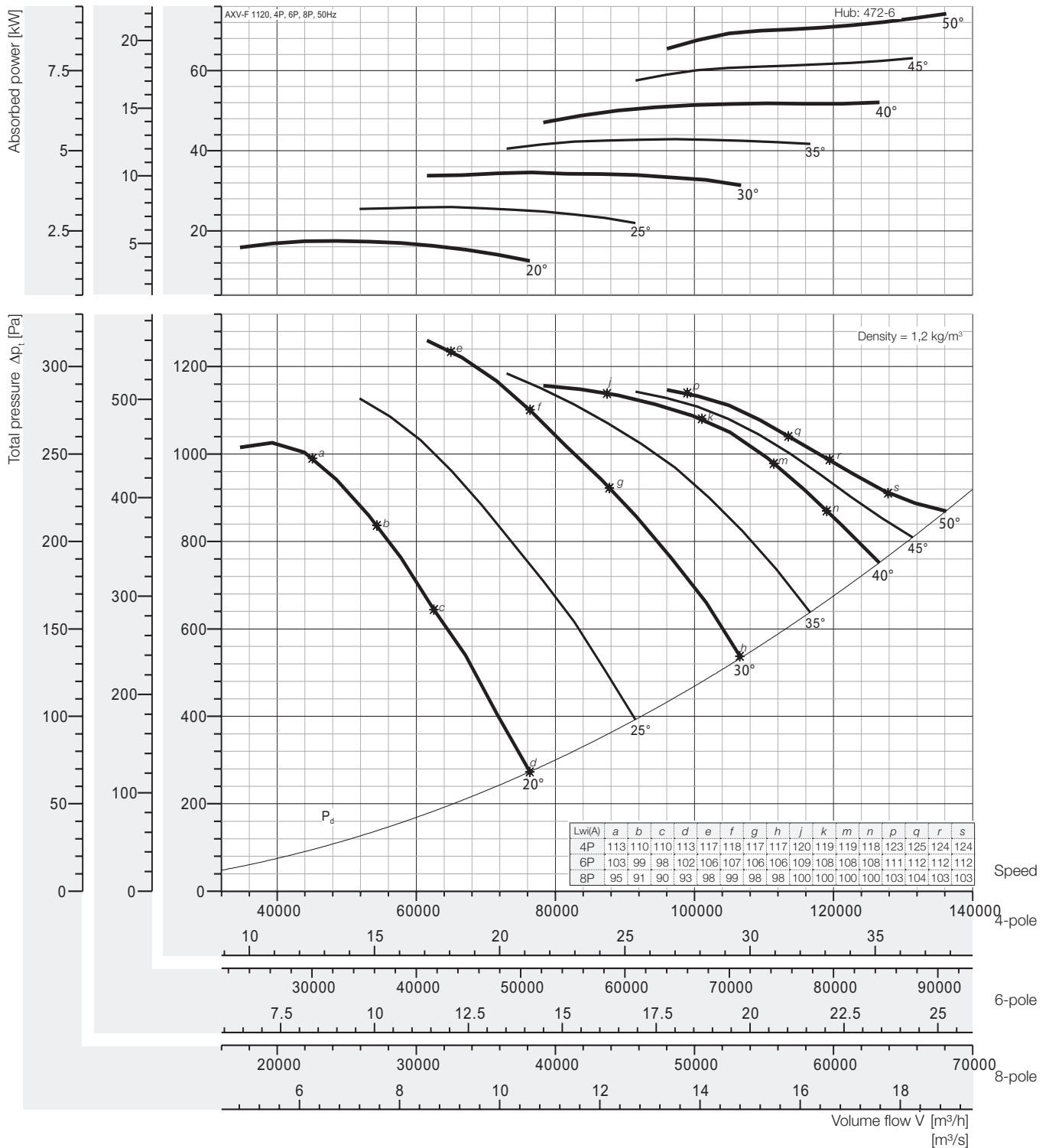

Peak absorbed power [kW]

4-pole = 1500 rpm; 6-pole = 1000 rpm; 8-pole = 750 rpm;

N Poles	Pitch angle [°]						
	20	25	30	35	40	45	50
4P motor	17,51	25,94	34,60	42,89	52,05	63,11	74,16
	18,5	30	37	45	55	75	
6P motor	5,187	7,686	10,25	12,71	15,42	18,70	21,97
	5,5	11		15	18,5	22	
8P motor	2,188	3,243	4,326	5,361	6,506	7,888	9,270
	2,2	4	5,5		7,5	11	

Fan test laboratory AMCA 210/99 Fig.12, Test Chamber. Performance certified is for installation type D - Ducted inlet, Ducted outlet. Performance ratings do not include the effects of appurtenances (accessories-belt cover, pulley & belt). Power rating (kW) does not include transmission losses.

The A-weighted sound ratings shown have been calculated per AMCA International Standard 301. Values shown are for inlet Lw(A) sound power levels for installation Type D: ducted inlet, ducted outlet. Ratings include the effects of duct end correction.



Performance Curve

AXV-F 1250, 50 Hz

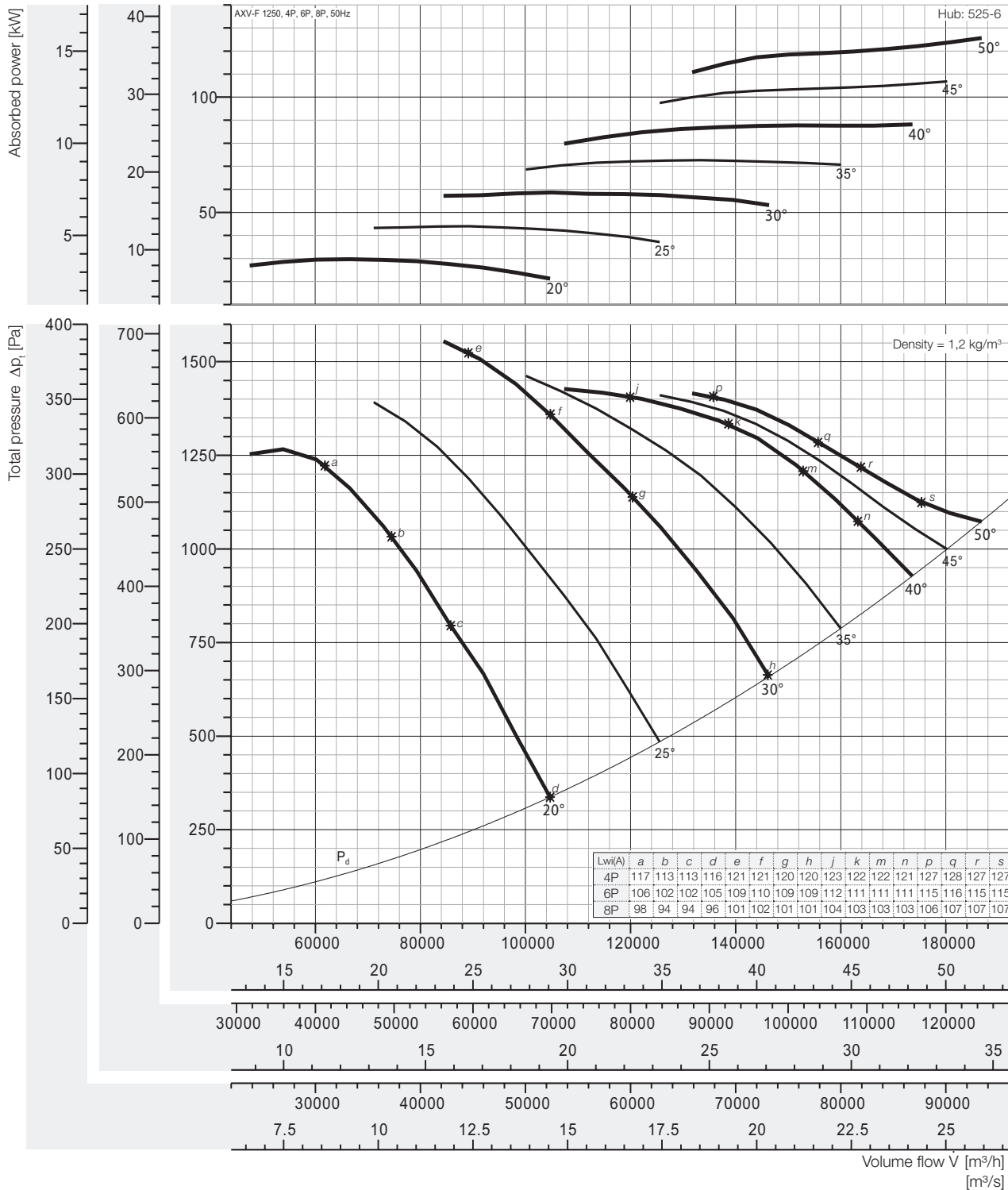

Peak absorbed power [kW]

4-pole = 1500 rpm; 6-pole = 1000 rpm; 8-pole = 750 rpm;

N Poles	Pitch angle [°]						
	20	25	30	35	40	45	50
4P motor	29,65	43,93	58,60	72,64	88,15	106,9	125,6
	30	45	75	90	-	-	-
6P motor	8,78	13,02	17,36	21,52	26,12	31,66	37,21
	11	15	18,5	22	30	37	45
8P motor	3,706	5,492	7,325	9,080	11,02	13,36	15,70
	4	5,5	7,5	11	15	18,5	25

Fan test laboratory AMCA 210/99 Fig.12, Test Chamber. Performance certified is for installation type D - Ducted inlet, Ducted outlet. Performance ratings do not include the effects of appurtenances (accessories-belt cover, pulley & belt). Power rating (kW) does not include transmission losses.

The A-weighted sound ratings shown have been calculated per AMCA International Standard 301. Values shown are for inlet Lw(A) sound power levels for installation Type D: ducted inlet, ducted outlet. Ratings include the effects of duct end correction.

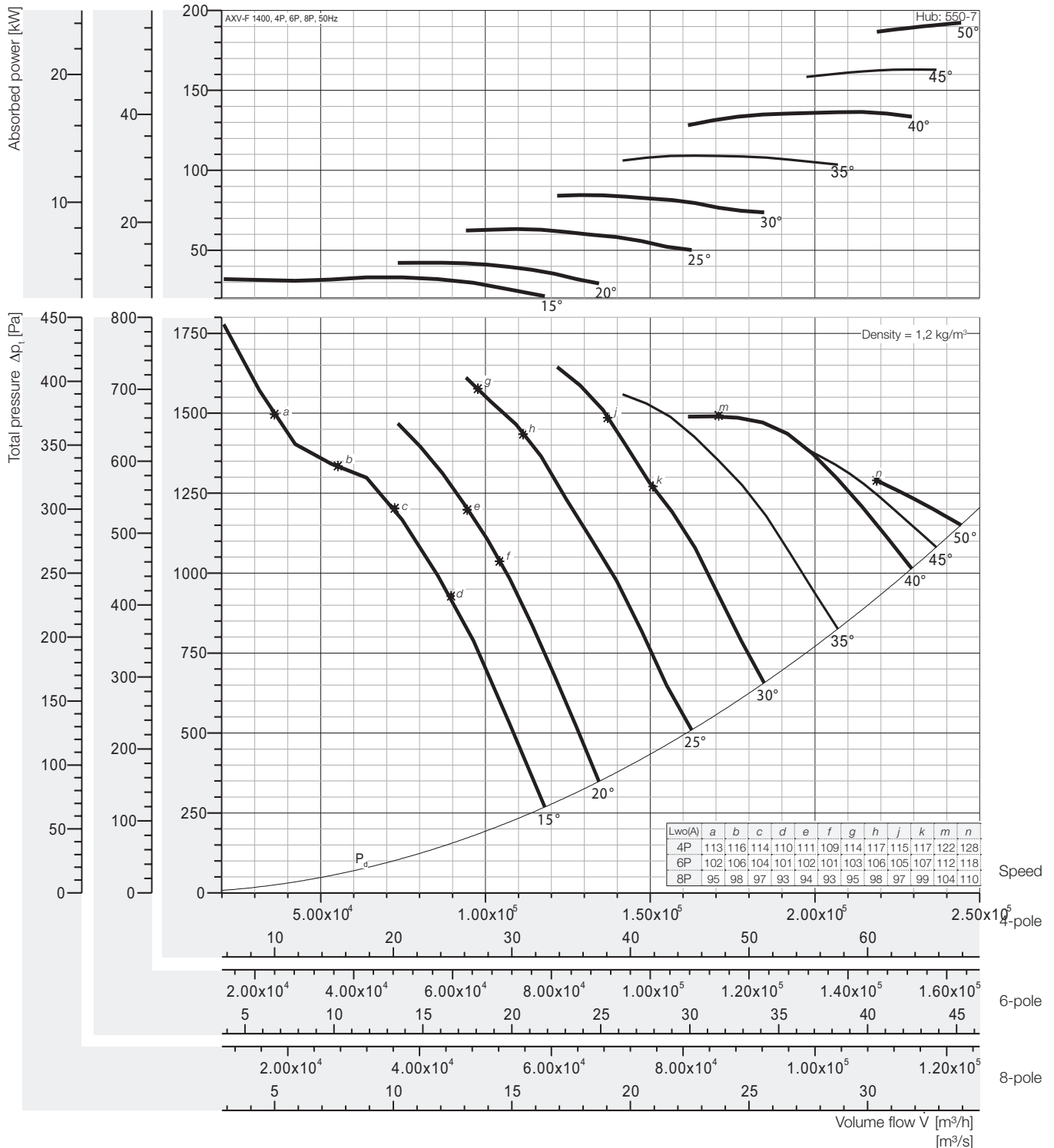

Peak absorbed power [kW]

4-pole = 1500 rpm; 6-pole = 1000 rpm; 8-pole = 750 rpm;

N Poles	Pitch angle [°]							
	15	20	25	30	35	40	45	50
4P motor	33,14	42,28	63,27	84,50	109,2	136,5	163,1	192,3
6P motor	9,819	12,53	18,75	25,04	32,36	40,45	48,32	56,98
8P motor	4,142	5,285	7,908	10,56	13,65	17,06	20,38	24,04

Fan test laboratory AMCA 210/99 Fig.15, Test Chamber. Performance certified is for installation type A - Free inlet, Free outlet. Performance ratings do not include the effects of appurtenances (accessories-belt cover, pulley & belt). Power rating (kW) does not include transmission losses.

The A-weighted sound ratings shown have been calculated per AMCA International Standard 301. Values shown are for outlet LwoA sound power levels for installation Type A: free inlet, free outlet.



Performance Curve

AXV-F 1600, 50 Hz

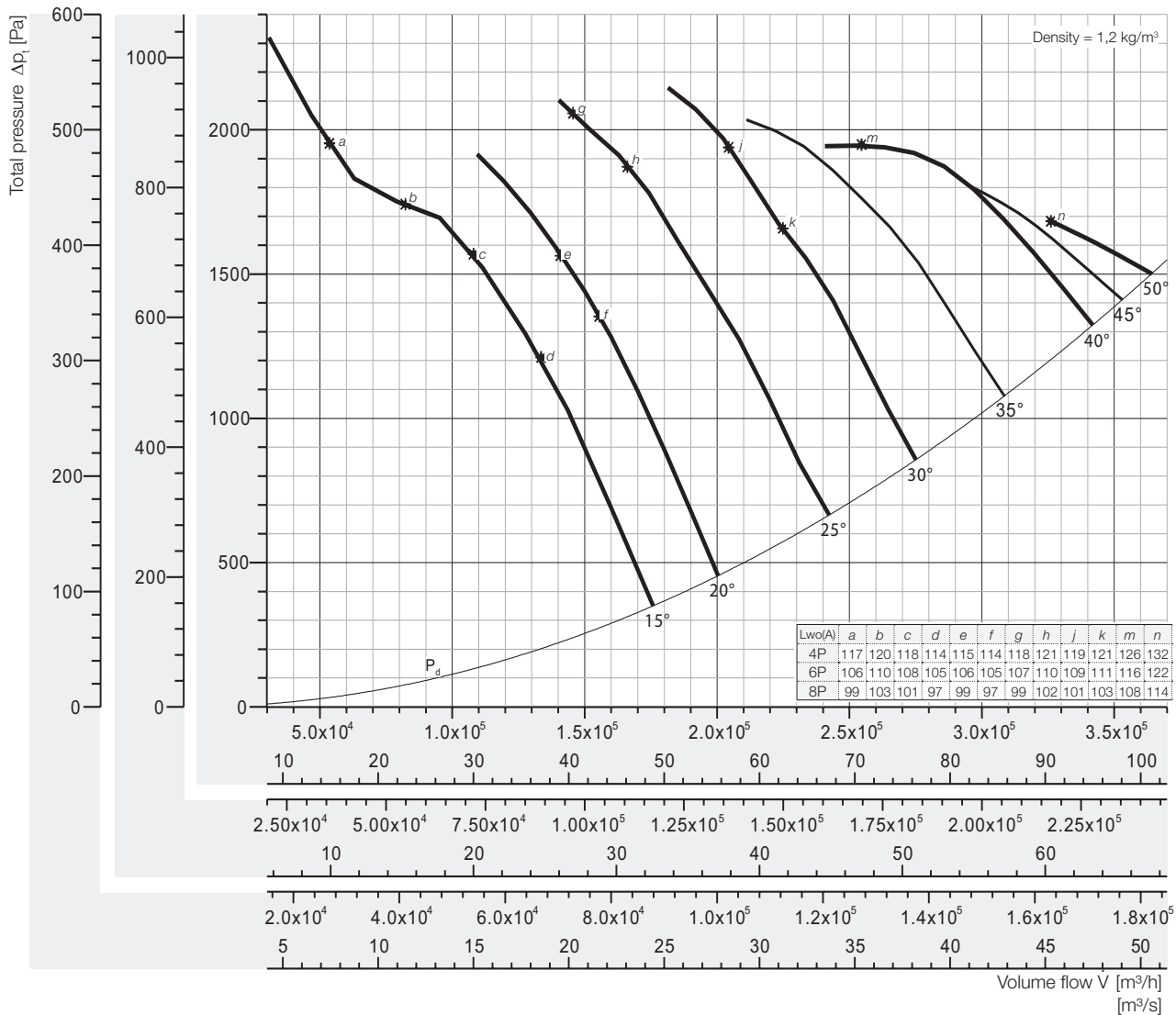
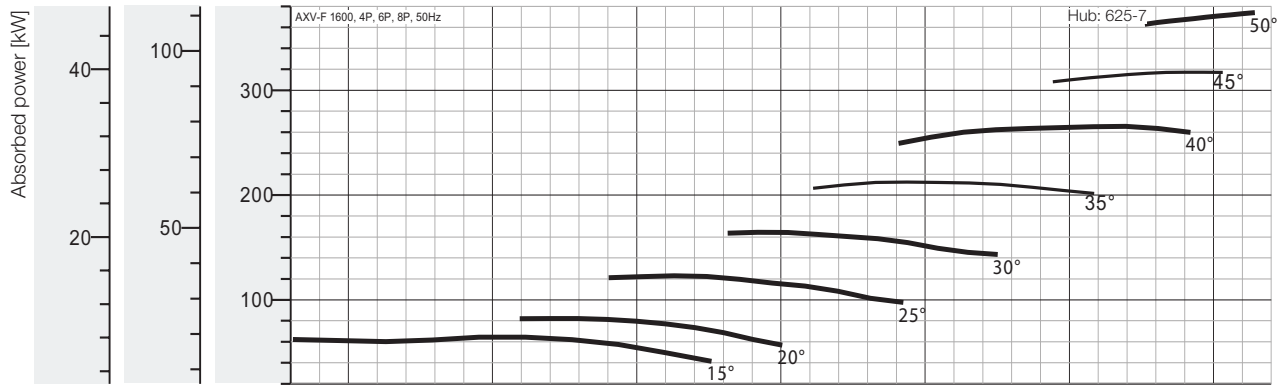

Speed
4-pole
6-pole
8-pole

Peak absorbed power [kW]

4-pole = 1500 rpm; 6-pole = 1000 rpm; 8-pole = 750 rpm;

N Poles	Pitch angle [°]							
	15	20	25	30	35	40	45	50
4P motor	64,46	82,25	123,1	164,4	212,4	265,6	317,2	374,1
6P motor	19,10	24,37	36,47	48,71	62,94	78,68	93,99	110,8
8P motor	8,058	10,28	15,38	20,55	26,55	33,19	39,65	46,76

Fan test laboratory AMCA 210/99 Fig.15, Test Chamber. Performance certified is for installation type A - Free inlet, Free outlet. Performance ratings do not include the effects of appurtenances (accessories-belt cover, pulley & belt). Power rating (kW) does not include transmission losses.

The A-weighted sound ratings shown have been calculated per AMCA International Standard 301. Values shown are for outlet LwoA sound power levels for installation Type A: free inlet, free outlet.

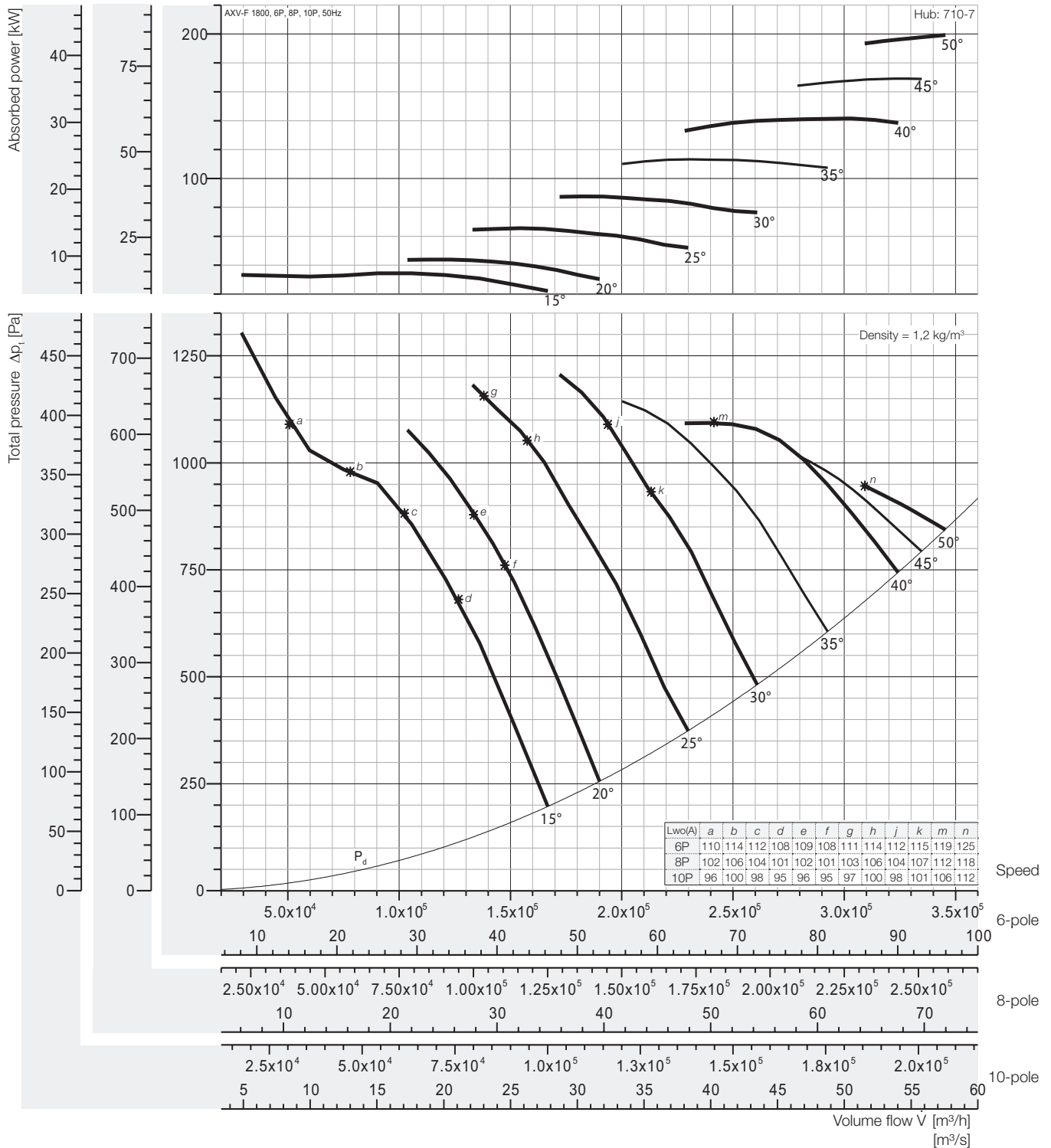

Peak absorbed power [kW]

6-pole = 1000 rpm; 8-pole = 750 rpm; 10-pole = 600 rpm;

N Poles	Pitch angle [°]							
	15	20	25	30	35	40	45	50
6P motor	34,36 37	43,84 45	65,60 75	87,62 90	113,2 132	141,5 160	169,1 200	199,4
8P motor	14,50 15	18,49 18,5	27,68 30	36,96 37	47,77 55	59,71 75	71,33 90	84,12
10P motor	7,422 7,5	9,470 11	14,17 15	18,93 22	24,46 30	30,57 37	36,52	43,07 45

Fan test laboratory AMCA 210/99 Fig.15, Test Chamber. Performance certified is for installation type A - Free inlet, Free outlet. Performance ratings do not include the effects of appurtenances (accessories-belt cover, pulley & belt). Power rating (kW) does not include transmission losses.

The A-weighted sound ratings shown have been calculated per AMCA International Standard 301. Values shown are for outlet LwoA sound power levels for installation Type A: free inlet, free outlet.



Performance Curve

AXV-F 2000, 50 Hz

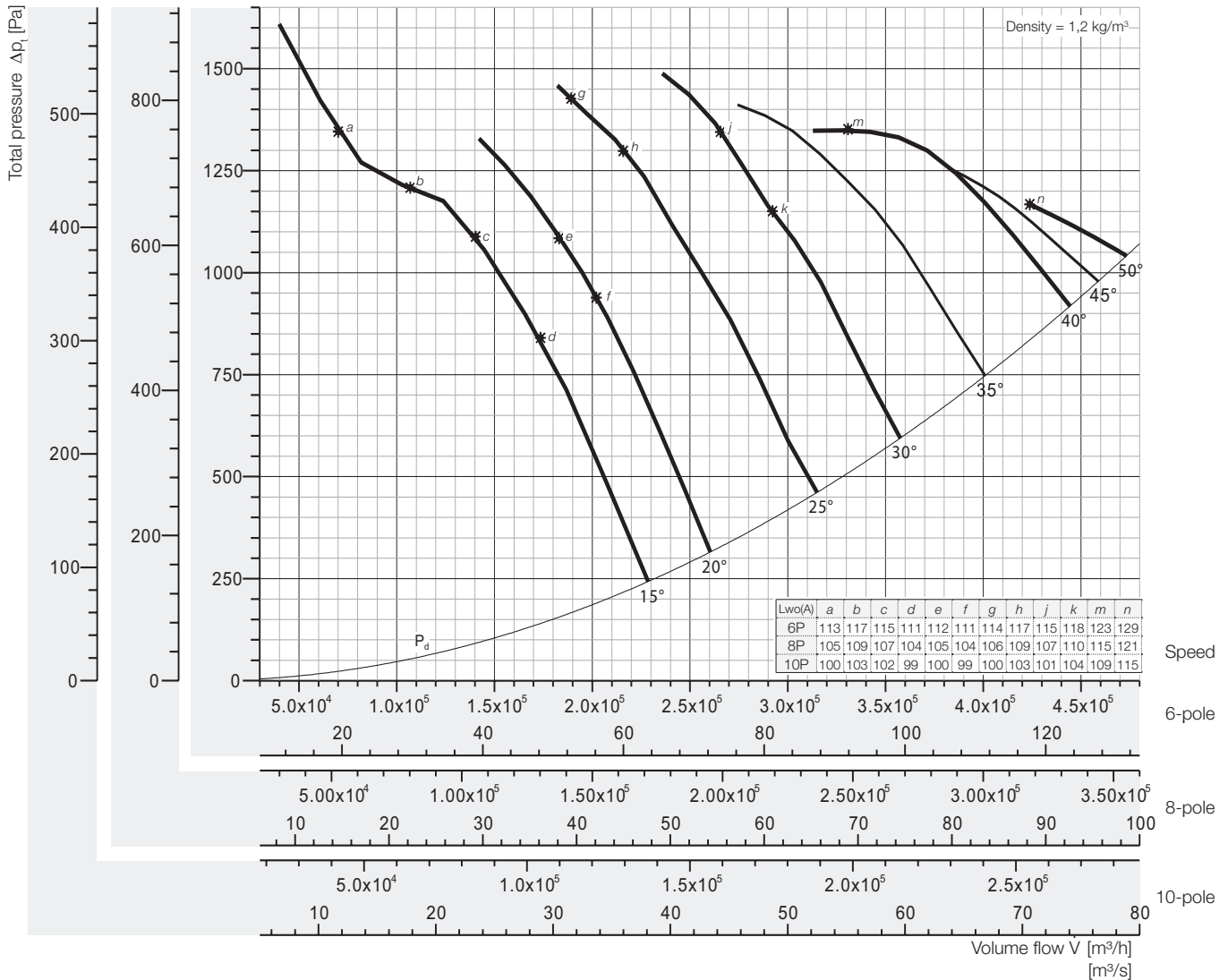
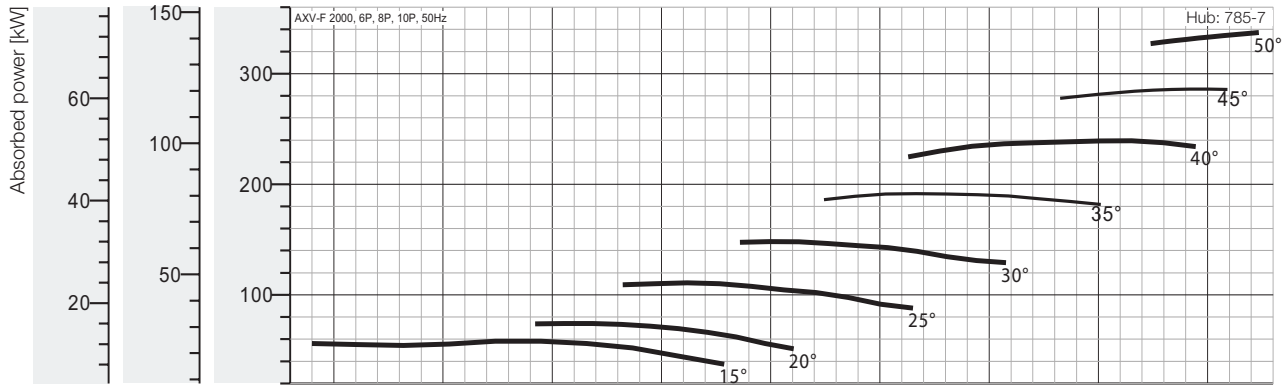

Peak absorbed power [kW]

6-pole = 1000 rpm; 8-pole = 750 rpm; 10-pole = 600 rpm;

N Poles	Pitch angle [°]							
	15	20	25	30	35	40	45	50
6P motor	58,11	74,14	110,9	148,2	191,5	239,4	285,9	337,2
8P motor	24,51	31,28	46,80	62,51	80,79	101,0	120,6	142,2
10P motor	12,55	16,01	23,96	32,01	41,36	51,71	61,76	72,84

Fan test laboratory AMCA 210/99 Fig.15, Test Chamber. Performance certified is for installation type A - Free inlet, Free outlet. Performance ratings do not include the effects of appurtenances (accessories-belt cover, pulley & belt). Power rating (kW) does not include transmission losses.

The A-weighted sound ratings shown have been calculated per AMCA International Standard 301. Values shown are for outlet Lw(A) sound power levels for installation Type A: free inlet, free outlet.

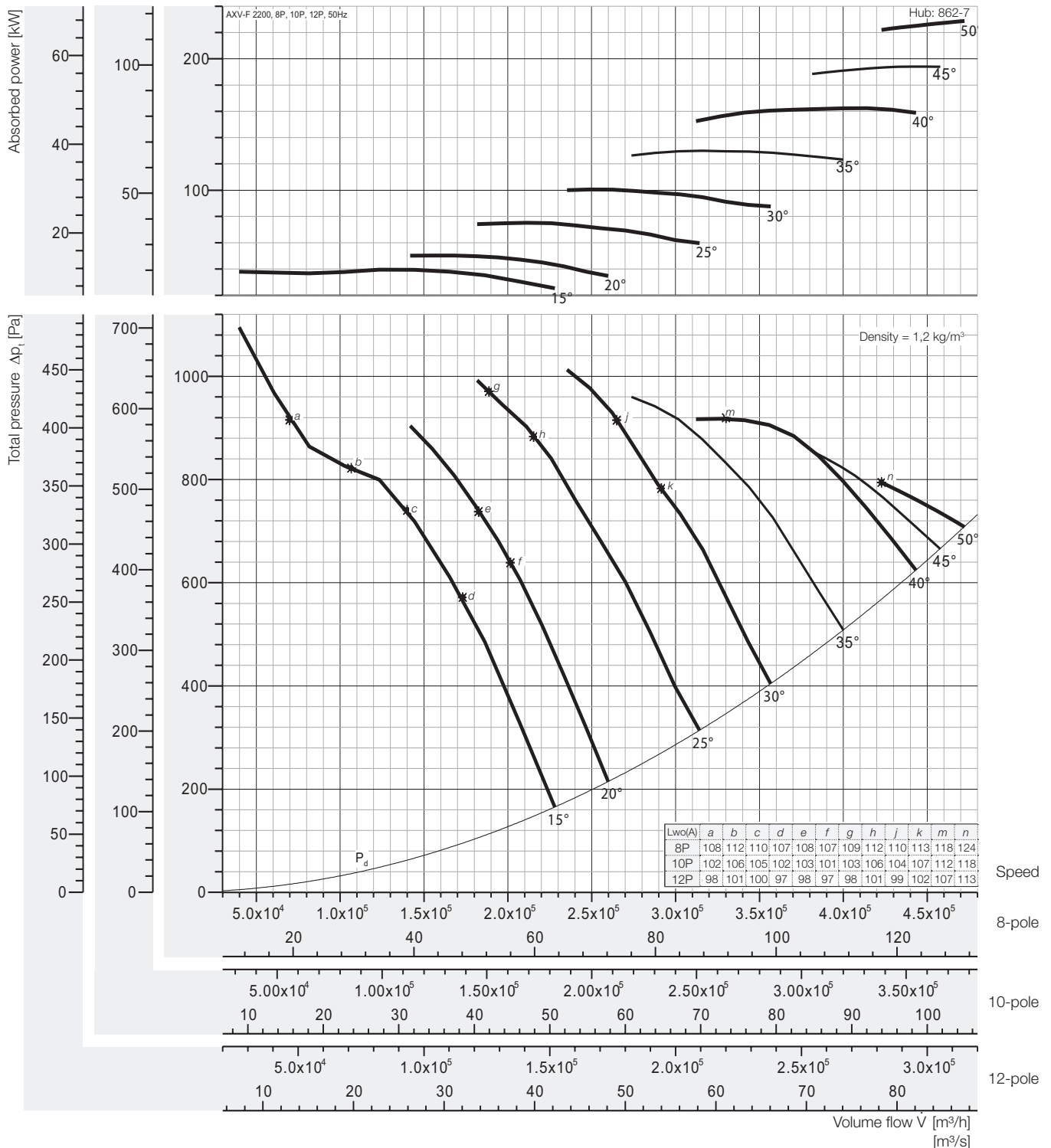

Peak absorbed power [kW]

8-pole = 750 rpm; 10-pole = 600 rpm; 12-pole = 500 rpm;

N Poles	Pitch angle [°]							
	15	20	25	30	35	40	45	50
8P motor	39,44	50,32	75,29	100,6	130,0	162,4	194,1	228,8
10P motor	20,19	25,76	38,55	51,49	66,54	83,18	99,36	117,2
12P motor	11,68	14,91	22,31	29,80	38,51	48,14	57,5	67,81

Fan test laboratory AMCA 210/99 Fig.15, Test Chamber. Performance certified is for installation type A - Free inlet, Free outlet. Performance ratings do not include the effects of appurtenances (accessories-belt cover, pulley & belt). Power rating (kW) does not include transmission losses.

The A-weighted sound ratings shown have been calculated per AMCA International Standard 301. Values shown are for outlet LwoA sound power levels for installation Type A: free inlet, free outlet.



Performance Curve

AXV-F 2400, 50 Hz

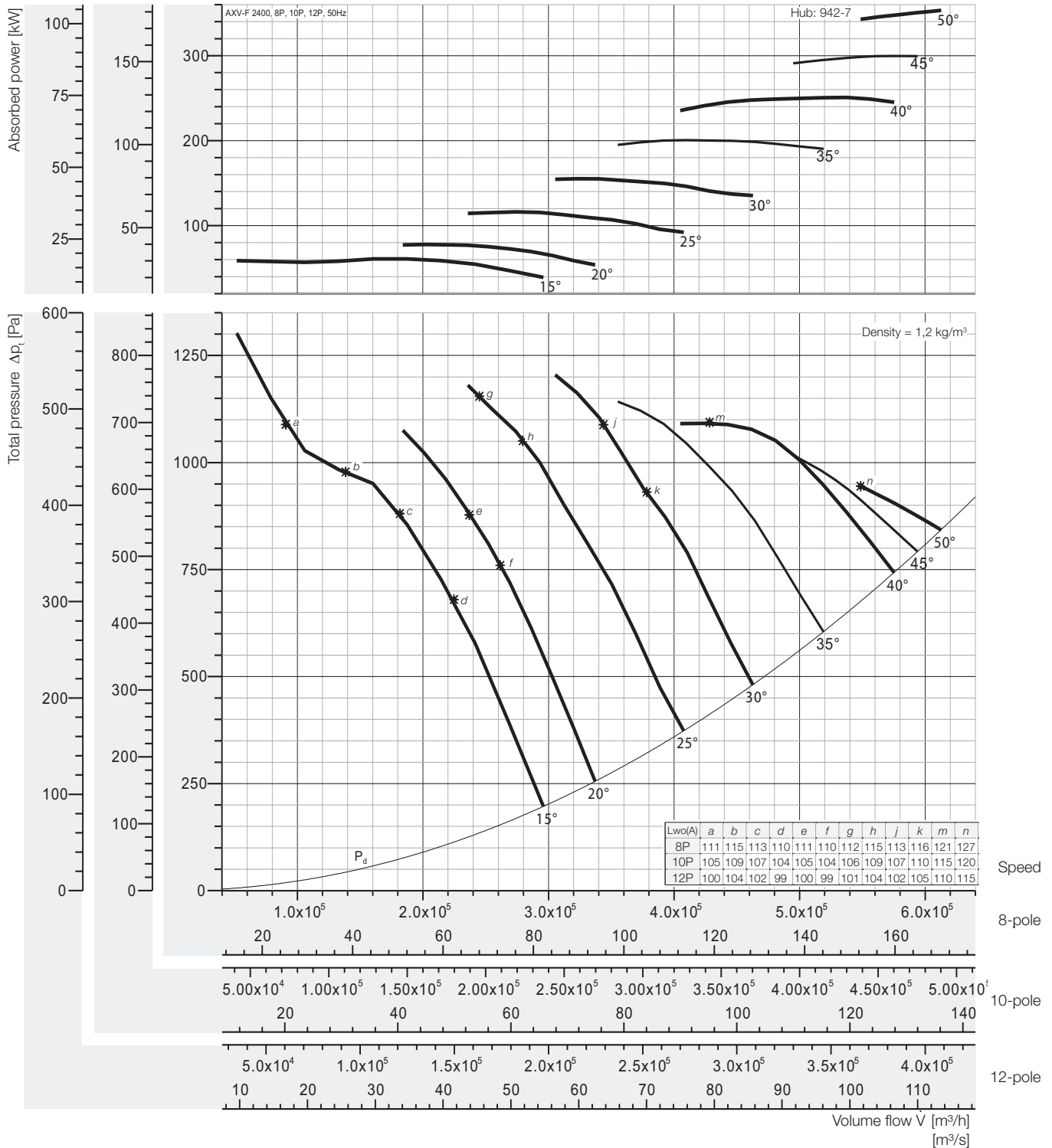

Peak absorbed power [kW]

8-pole = 750 rpm; 10-pole = 600 rpm; 12-pole = 500 rpm;

N Poles	Pitch angle [°]							
	15	20	25	30	35	40	45	50
8P motor	60,87	77,67	116,2	155,2	200,6	250,8	299,5	353,2
	75	90	132	160	250	315		355
10P motor	31,17	39,77	59,50	79,48	102,7	128,4	153,4	180,9
	37	45	75	90	110	132	160	200
12P motor	18,04	23,01	34,44	45,99	59,44	74,30	88,76	104,7
	18,5	30	37	55	75		90	110

Fan test laboratory AMCA 210/99 Fig.15, Test Chamber. Performance certified is for installation type A - Free inlet, Free outlet. Performance ratings do not include the effects of appurtenances (accessories-belt cover, pulley & belt). Power rating (kW) does not include transmission losses.

The A-weighted sound ratings shown have been calculated per AMCA International Standard 301. Values shown are for outlet Lw_oA sound power levels for installation Type A: free inlet, free outlet.

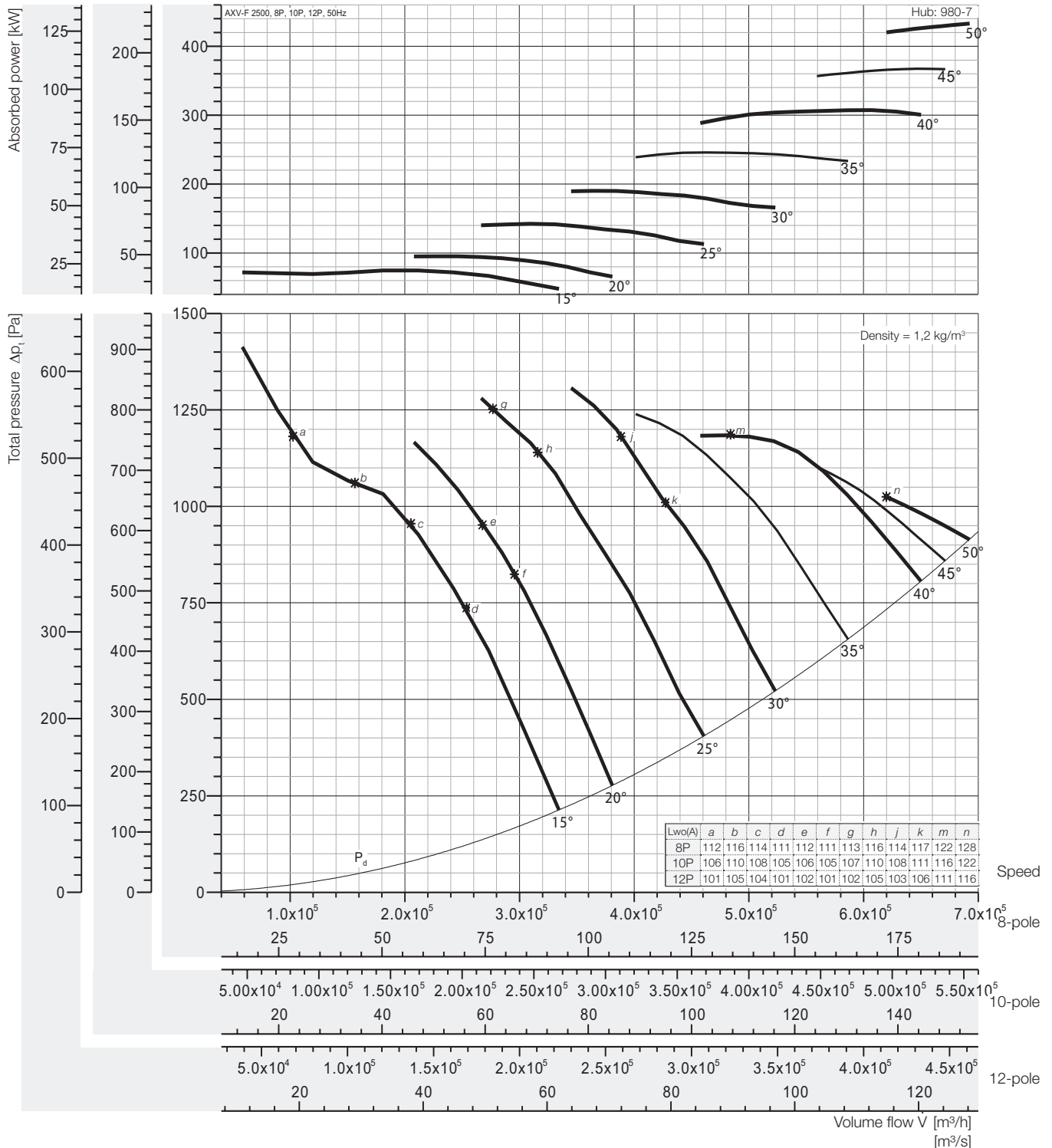

Peak absorbed power [kW]

8-pole = 750 rpm; 10-pole = 600 rpm; 12-pole = 500 rpm;

N Poles	Pitch angle [°]							
	15	20	25	30	35	40	45	50
8P motor	74,63	95,22	142,5	190,3	245,9	307,4	367,2	433,1
10P motor	38,22	48,75	72,95	97,43	125,9	157,4	188,0	221,7
12P motor	22,11	28,21	42,22	56,39	72,87	91,09	108,8	128,3

Fan test laboratory AMCA 210/99 Fig.15, Test Chamber. Performance certified is for installation type A - Free inlet, Free outlet. Performance ratings do not include the effects of appurtenances (accessories-belt cover, pulley & belt). Power rating (kW) does not include transmission losses.

The A-weighted sound ratings shown have been calculated per AMCA International Standard 301. Values shown are for outlet LwoA sound power levels for installation Type A: free inlet, free outlet.



Performance Curve

AXV-F 2600, 50 Hz

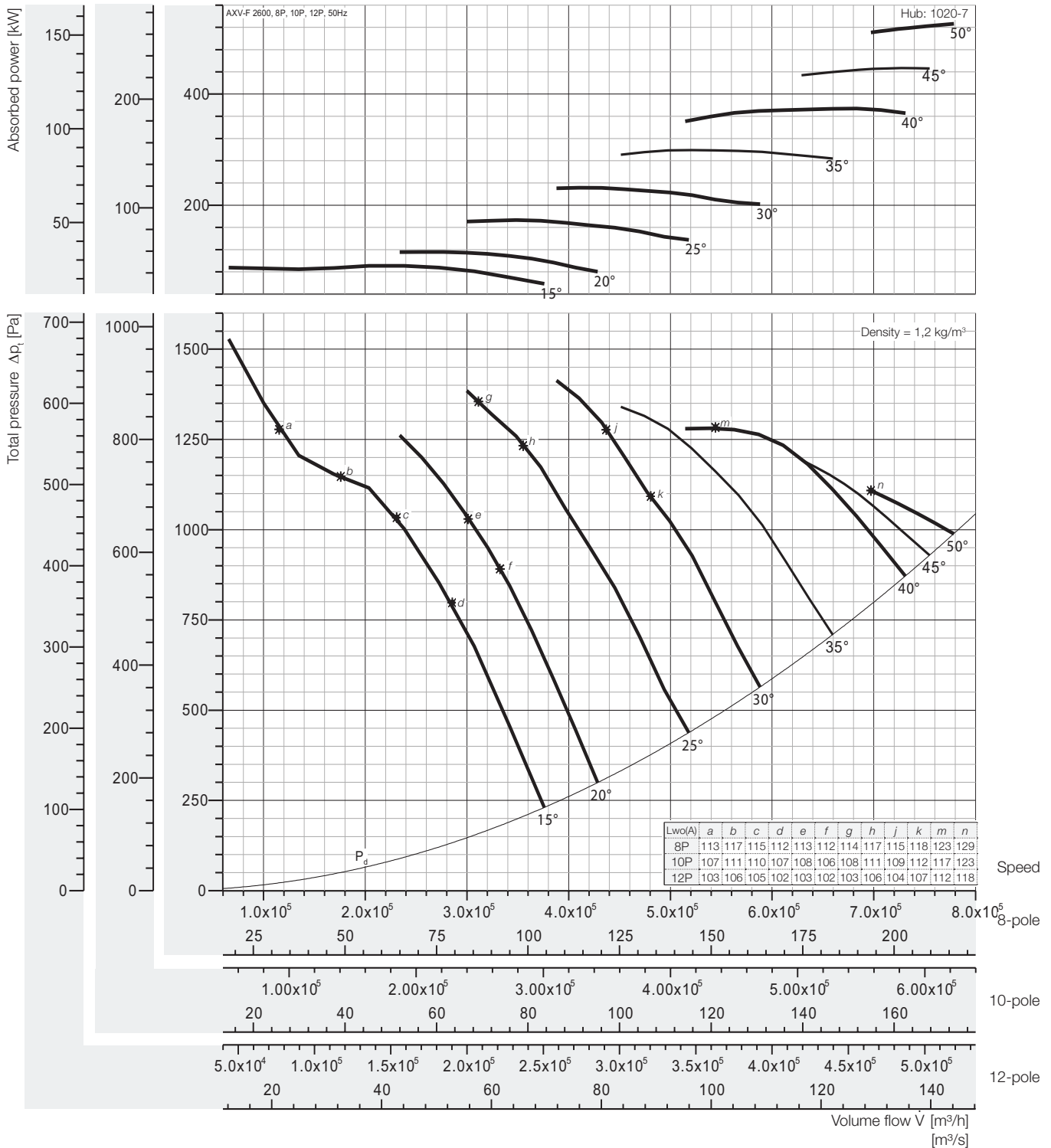

Peak absorbed power [kW]

8-pole = 750 rpm; 10-pole = 600 rpm; 12-pole = 500 rpm;

N Poles	Pitch angle [°]							
	15	20	25	30	35	40	45	50
8P motor	90,76	115,8	173,3	231,4	299,1	373,9	446,6	526,7
10P motor	46,47	59,29	88,72	118,50	153,13	191,4	228,7	269,6
12P motor	26,89	34,31	51,34	68,58	88,62	110,8	132,3	156,0

Fan test laboratory AMCA 210/99 Fig.15, Test Chamber. Performance certified is for installation type A - Free inlet, Free outlet. Performance ratings do not include the effects of appurtenances (accessories-belt cover, pulley & belt). Power rating (kW) does not include transmission losses.

The A-weighted sound ratings shown have been calculated per AMCA International Standard 301. Values shown are for outlet LwoA sound power levels for installation Type A: free inlet, free outlet.

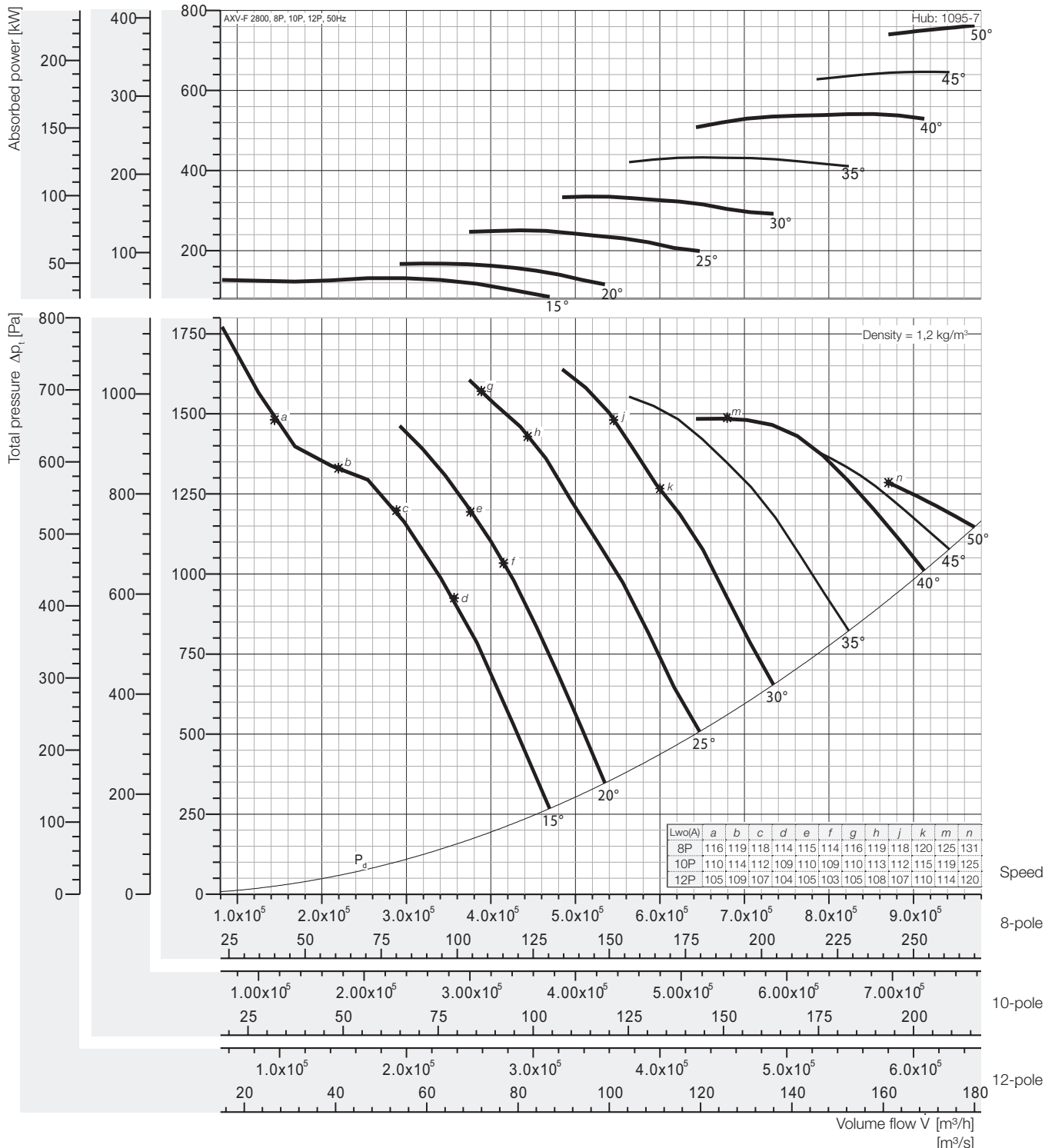

Peak absorbed power [kW]

8-pole = 750 rpm; 10-pole = 600 rpm; 12-pole = 500 rpm;

N Poles	Pitch angle [°]							
	15	20	25	30	35	40	45	50
8P	131,4	167,6	250,8	335,0	432,9	541,2	646,5	762,4
motor	132	200	315	355	450	560	710	-
10P	67,26	85,82	128,4	171,5	221,7	277,1	331,0	390,3
motor	75	90	132	200	250	315	355	400
12P	38,93	49,67	74,32	99,26	128,3	160,3	191,5	225,9
motor	45	55	75	110	132	200	250	250

Fan test laboratory AMCA 210/99 Fig.15, Test Chamber. Performance certified is for installation type A - Free inlet, Free outlet. Performance ratings do not include the effects of appurtenances (accessories-belt cover, pulley & belt). Power rating (kW) does not include transmission losses.

The A-weighted sound ratings shown have been calculated per AMCA International Standard 301. Values shown are for outlet LwoA sound power levels for installation Type A: free inlet, free outlet.

AMCA - FEG rating

Fan Efficiency Grade: AXV-F



Certified FEGs are determined in accordance with AMCA 205-12 Energy Efficiency Classification for fans. In conjunction with AMCA 211-13 (Rev. 2015) Certified Ratings Program, Product Rating Manual for Fan Air Performance. This classification is based on fan peak (optimum) total efficiency for a given fan speed, fan size and application category. For the purpose of energy classification, the peak efficiency can be determined at a speed not higher than the maximum design speed of the fan.

The AMCA Certified Ratings Seal applies to the Fan Efficiency Grade (FEG) for AXV-F series Axial Fan model AXV-F 500 to AXV-F 2800 as shown in the table below.

Fan Model No.	Fan Speed (rpm)	Fan Outlet Area (m ²)	Fan Efficiency Grades	Fan Model No.	Fan Speed (rpm)	Fan Outlet Area (m ²)	Fan Efficiency Grade
AXV-F 500	3600/1800/1200	0,1987	FEG 80	AXV-F 1400	1800/1200/900	1,5504	FEG 80
AXV-F 560	3600/1800/1200	0,2507	FEG 75	AXV-F 1600	1800/1200/900	2,0232	FEG 80
AXV-F 630	3600/1800/1200	0,3157	FEG 75	AXV-F 1800	1200/900/720	2,5588	FEG 80
AXV-F 710	3600/1800/1200	0,3970	FEG 75	AXV-F 2000	1200/900/720	3,1573	FEG 80
AXV-F 800	1800/1200/900	0,4989	FEG 75	AXV-F 2200	900/720/600	3,8186	FEG 80
AXV-F 900	1800/1200/900	0,6277	FEG 75	AXV-F 2400	900/720/600	4,5428	FEG 80
AXV-F 1000	1800/1200/900	0,7901	FEG 75	AXV-F 2500	900/720/600	4,9284	FEG 80
AXV-F 1120	1800/1200/900	0,9940	FEG 75	AXV-F 2600	900/720/600	5,3297	FEG 80
AXV-F 1250	1800/1200/900	1,2272	FEG 75	AXV-F 2800	900/720/600	6,1795	FEG 80

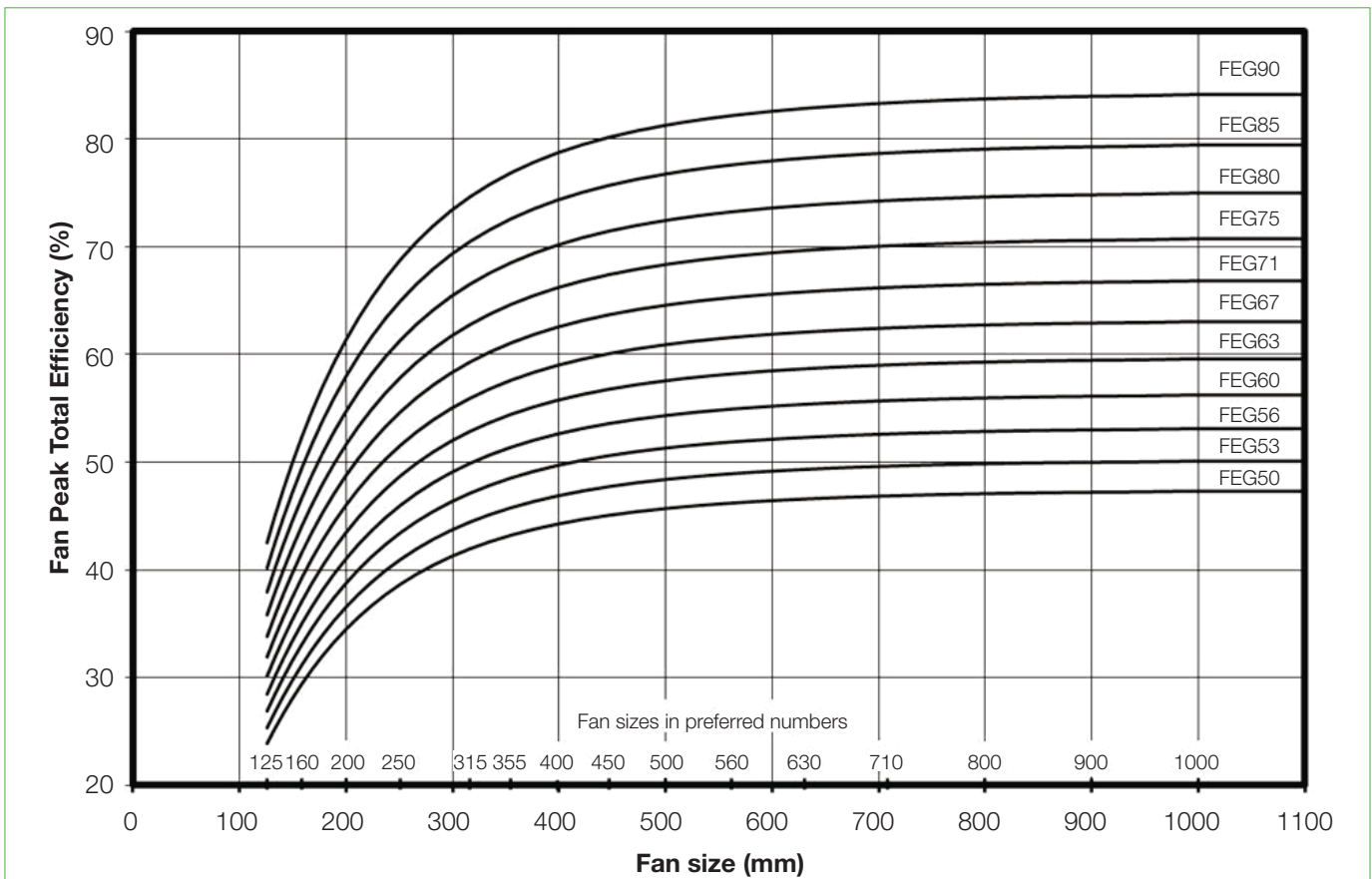

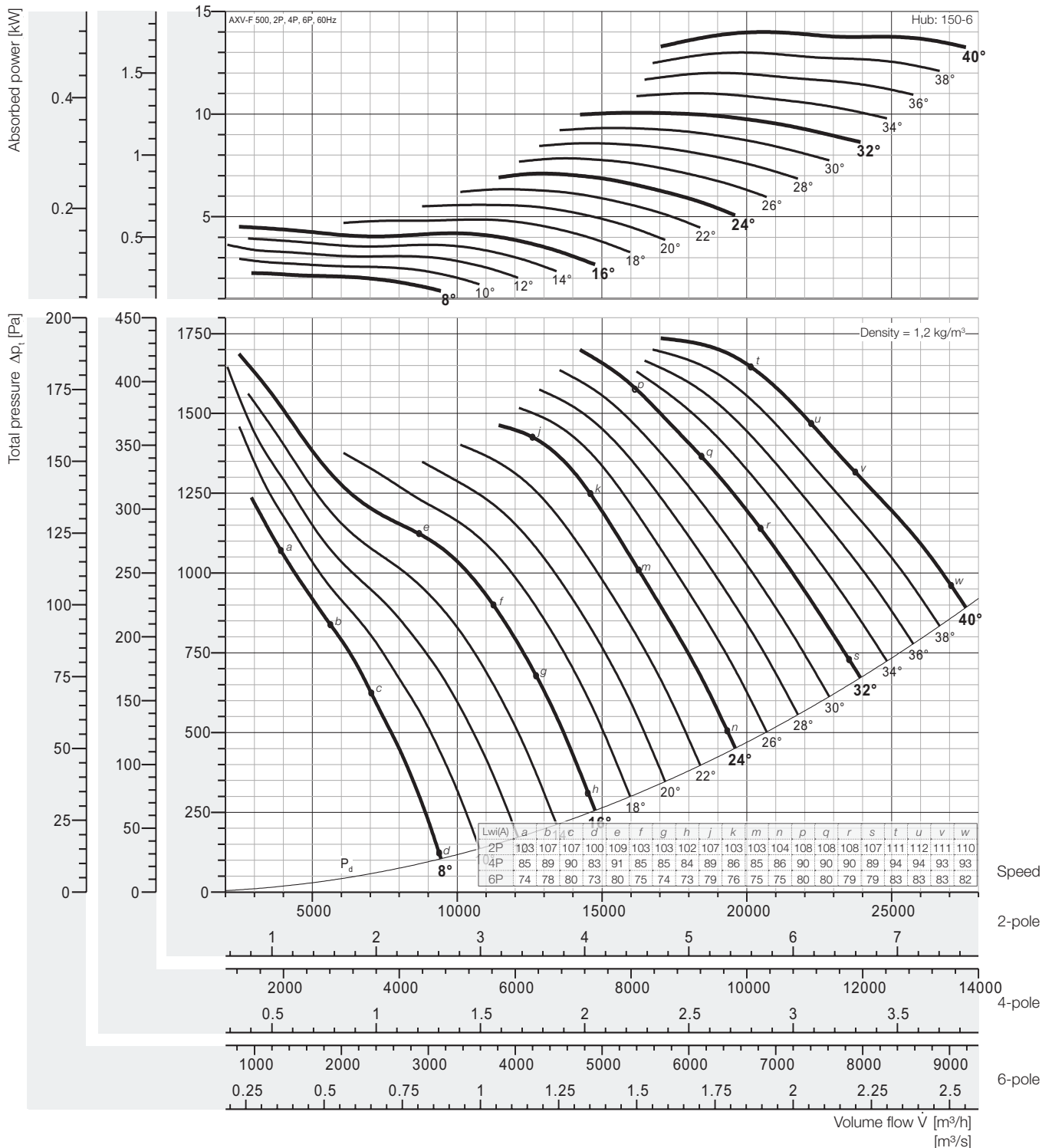

Peak absorbed power [kW]

2-pole = 3600 rpm; 4-pole = 1800 rpm; 6-pole = 1200 rpm;

N Poles	Pitch angle [°]																
	8	10	12	14	16	18	20	22	24	26	28	30	32	34	36	38	40
2P motor	2,251	2,943	3,634	3,936	4,511	4,859	5,572	6,333	7,099	7,839	8,580	9,322	10,06	11,01	12,00	13,00	14,00
	3,0		4,0		-*												
4P motor	0,281	0,368	0,454	0,492	0,564	0,607	0,696	0,792	0,887	0,980	1,072	1,165	1,258	1,376	1,500	1,625	1,749
	0,37		0,55		0,75			1,1				1,5				2,2	
6P motor	0,083	0,109	0,135	0,146	0,167	0,180	0,206	0,235	0,263	0,290	0,318	0,345	0,373	0,408	0,445	0,481	0,518
	0,25								0,37				0,55				

Fan test laboratory AMCA 210/99 Fig.12, Test Chamber. Performance certified is for installation type D - Ducted inlet, Ducted outlet. Performance ratings do not include the effects of appurtenances (accessories-belt cover, pulley & belt). Power rating (kW) does not include transmission losses.

The A-weighted sound ratings shown have been calculated per AMCA International Standard 301. Values shown are for inlet Lw(A) sound power levels for installation Type D: ducted inlet, ducted outlet. Ratings include the effects of duct end correction.



Performance Curve

AXV-F 560, 60 Hz

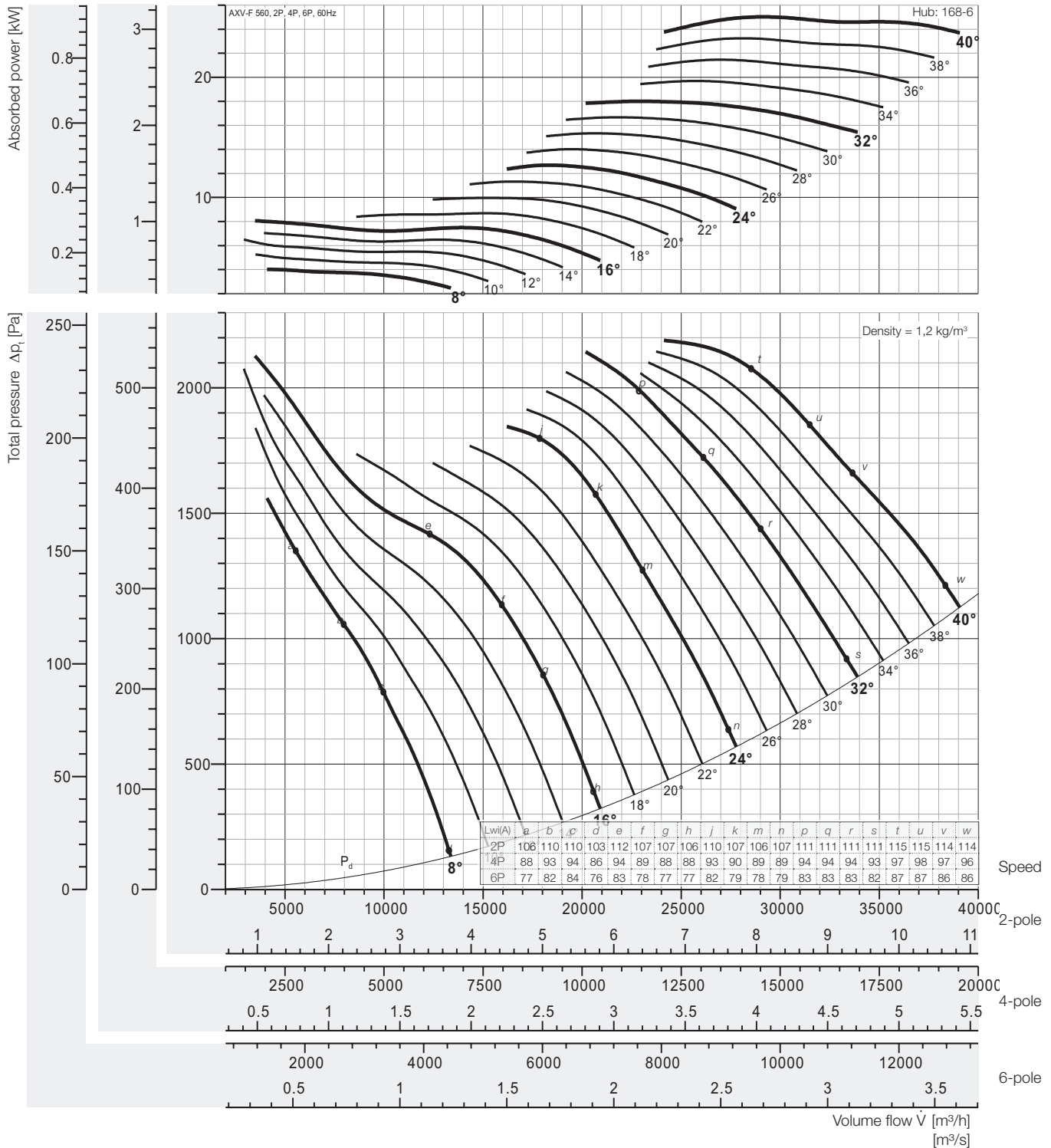

Peak absorbed power [kW]

2-pole = 3600 rpm; 4-pole = 1800 rpm; 6-pole = 1200 rpm;

N Poles	Pitch angle [°]																			
	8	10	12	14	16	18	20	22	24	26	28	30	32	34	36	38	40			
2P motor	4,024	5,261	6,499	7,037	8,065	8,689	9,962	11,32	12,69	14,02	15,34	16,67	18,00	19,69	2,146	23,24	25,03			
4P motor	0,503	0,658	0,812	0,880	1,008	1,086	1,245	1,415	1,587	1,752	1,918	2,084	2,250	2,461	2,682	2,905	3,128			
6P motor	0,149	0,195	0,241	0,261	0,299	0,322	0,369	0,419	0,470	0,519	0,568	0,617	0,667	0,729	0,795	0,861	0,927			

Fan test laboratory AMCA 210/99 Fig.12, Test Chamber. Performance certified is for installation type D - Ducted inlet, Ducted outlet. Performance ratings do not include the effects of appurtenances (accessories-belt cover, pulley & belt). Power rating (kW) does not include transmission losses.

The A-weighted sound ratings shown have been calculated per AMCA International Standard 301. Values shown are for inlet Lw(A) sound power levels for installation Type D: ducted inlet, ducted outlet. Ratings include the effects of duct end correction.

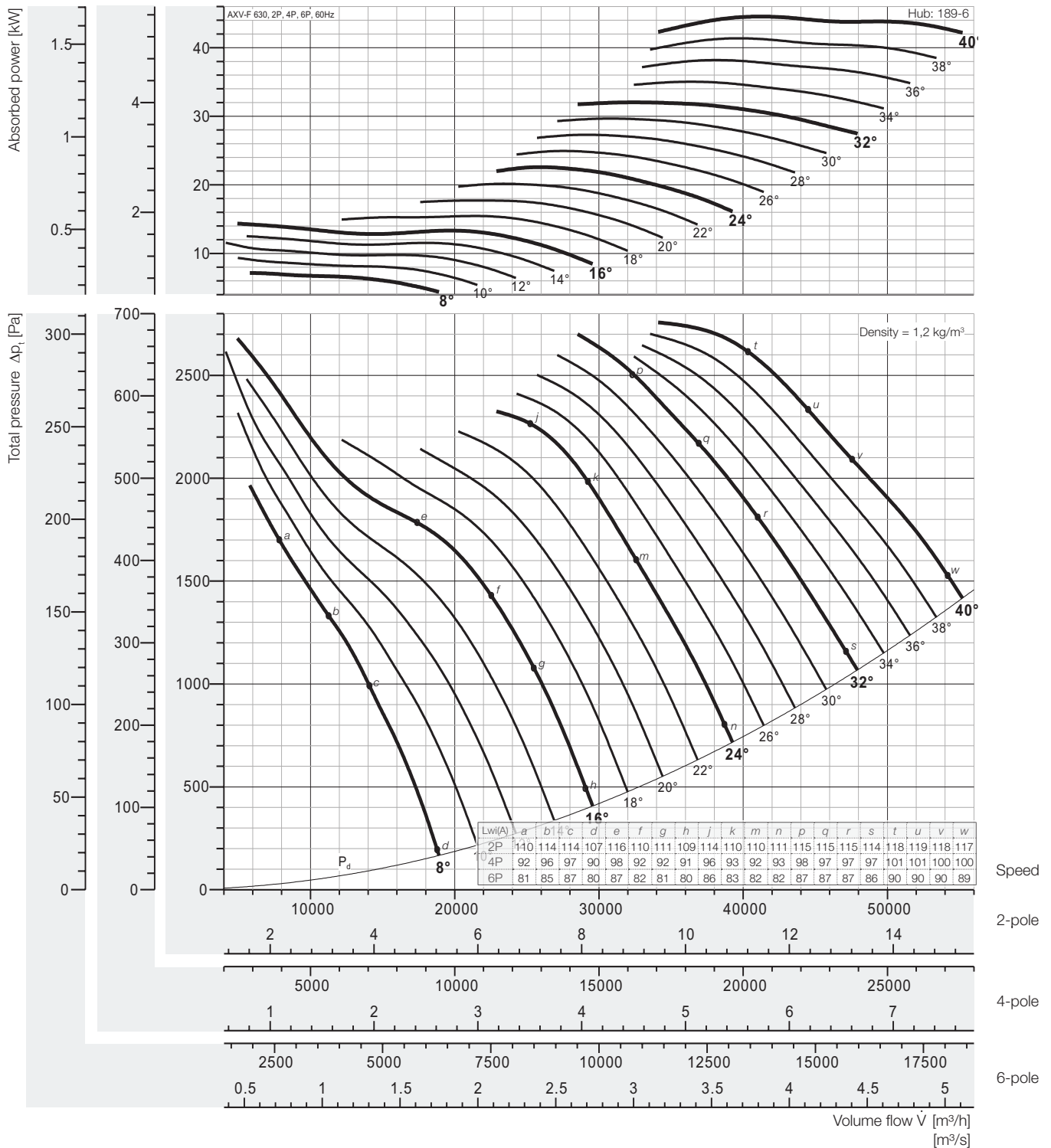

Peak absorbed power [kW]

2-pole = 3600 rpm; 4-pole = 1800 rpm; 6-pole = 1200 rpm;

N Poles	Pitch angle [°]																
	8	10	12	14	16	18	20	22	24	26	28	30	32	34	36	38	40
2P motor	7,163	9,364	11,57	12,53	14,36	15,46	17,73	20,15	22,59	24,95	27,31	29,67	32,03	35,04	38,19	41,36	44,54
4P motor	0,895	1,171	1,446	1,566	1,794	1,933	2,216	2,519	2,824	3,118	3,413	3,708	4,004	4,038	4,774	5,170	5,568
6P motor	0,265	0,347	0,428	0,464	0,532	0,573	0,657	0,746	0,837	0,924	1,011	1,099	1,186	1,298	1,415	1,532	1,650

Fan test laboratory AMCA 210/99 Fig.12, Test Chamber. Performance certified is for installation type D - Ducted inlet, Ducted outlet. Performance ratings do not include the effects of appurtenances (accessories-belt cover, pulley & belt). Power rating (kW) does not include transmission losses.

The A-weighted sound ratings shown have been calculated per AMCA International Standard 301. Values shown are for inlet Lw(A) sound power levels for installation Type D: ducted inlet, ducted outlet. Ratings include the effects of duct end correction.



Performance Curve

AXV-F 710, 60 Hz

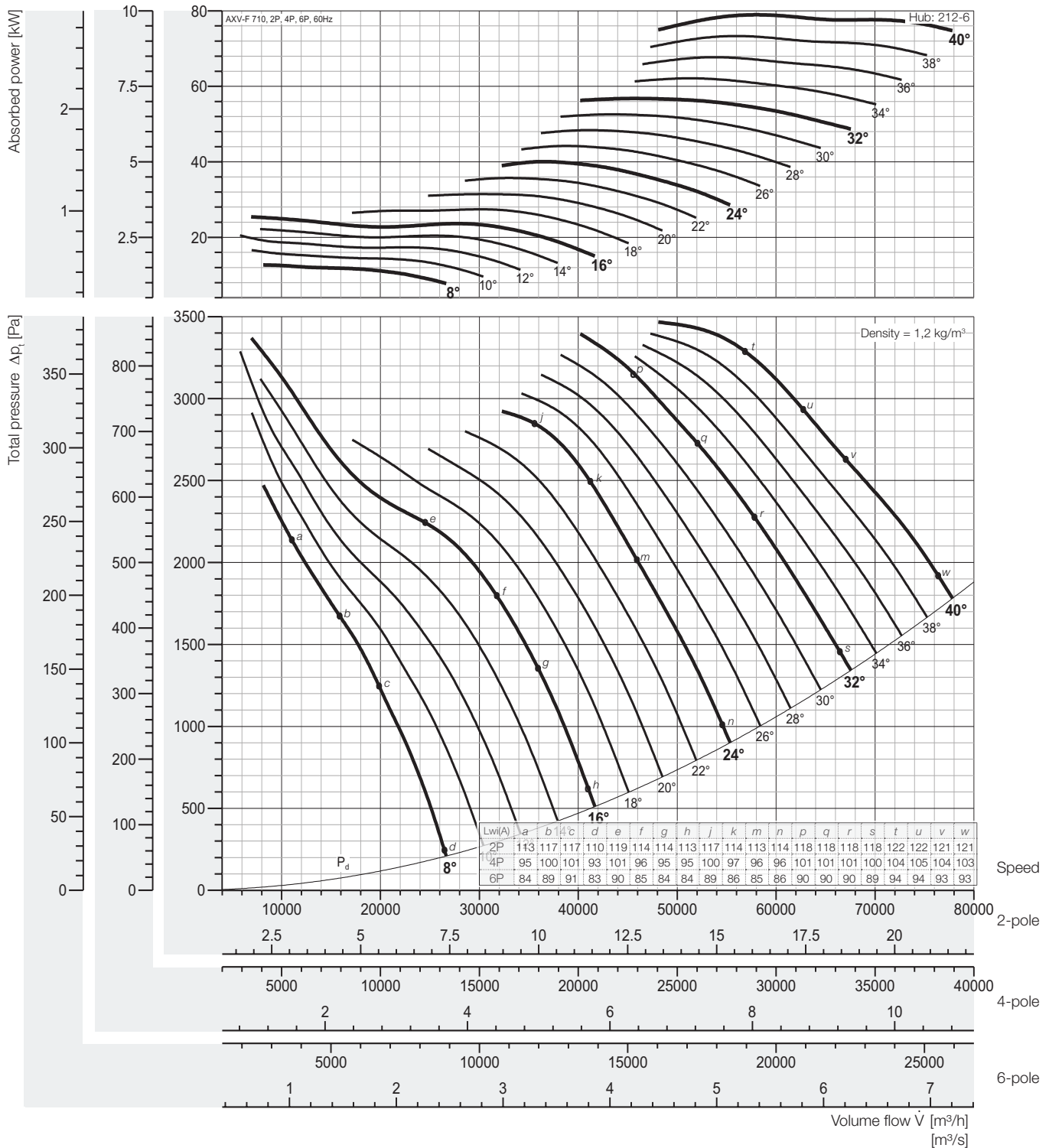

Peak absorbed power [kW]

2-pole = 3600 rpm; 4-pole = 1800 rpm; 6-pole = 1200 rpm;

N Poles	Pitch angle [°]																
	8	10	12	14	16	18	20	22	24	26	28	30	32	34	36	38	40
2P motor	12,70	16,60	20,50	22,20	25,45	27,41	31,43	35,72	40,05	44,22	48,40	52,59	56,78	62,12	67,71	73,32	78,95
	15	18,5	22	-*													
4P motor	1,587	2,075	2,563	2,775	3,181	3,427	3,929	4,465	5,006	5,527	6,050	6,574	7,098	7,765	8,463	9,165	9,87
	2,2		3,0		4,0			5,5		7,5				11			
6P motor	0,470	0,615	0,759	0,822	0,942	1,015	1,164	1,323	1,483	1,638	1,793	1,948	2,103	2,301	2,508	2,716	2,92
	0,55	0,75	1,1				1,5			2,2				3,0			

Fan test laboratory AMCA 210/99 Fig.12, Test Chamber. Performance certified is for installation type D - Ducted inlet, Ducted outlet. Performance ratings do not include the effects of appurtenances (accessories-belt cover, pulley & belt). Power rating (kW) does not include transmission losses.

The A-weighted sound ratings shown have been calculated per AMCA International Standard 301. Values shown are for inlet Lw(A) sound power levels for installation Type D: ducted inlet, ducted outlet. Ratings include the effects of duct end correction.

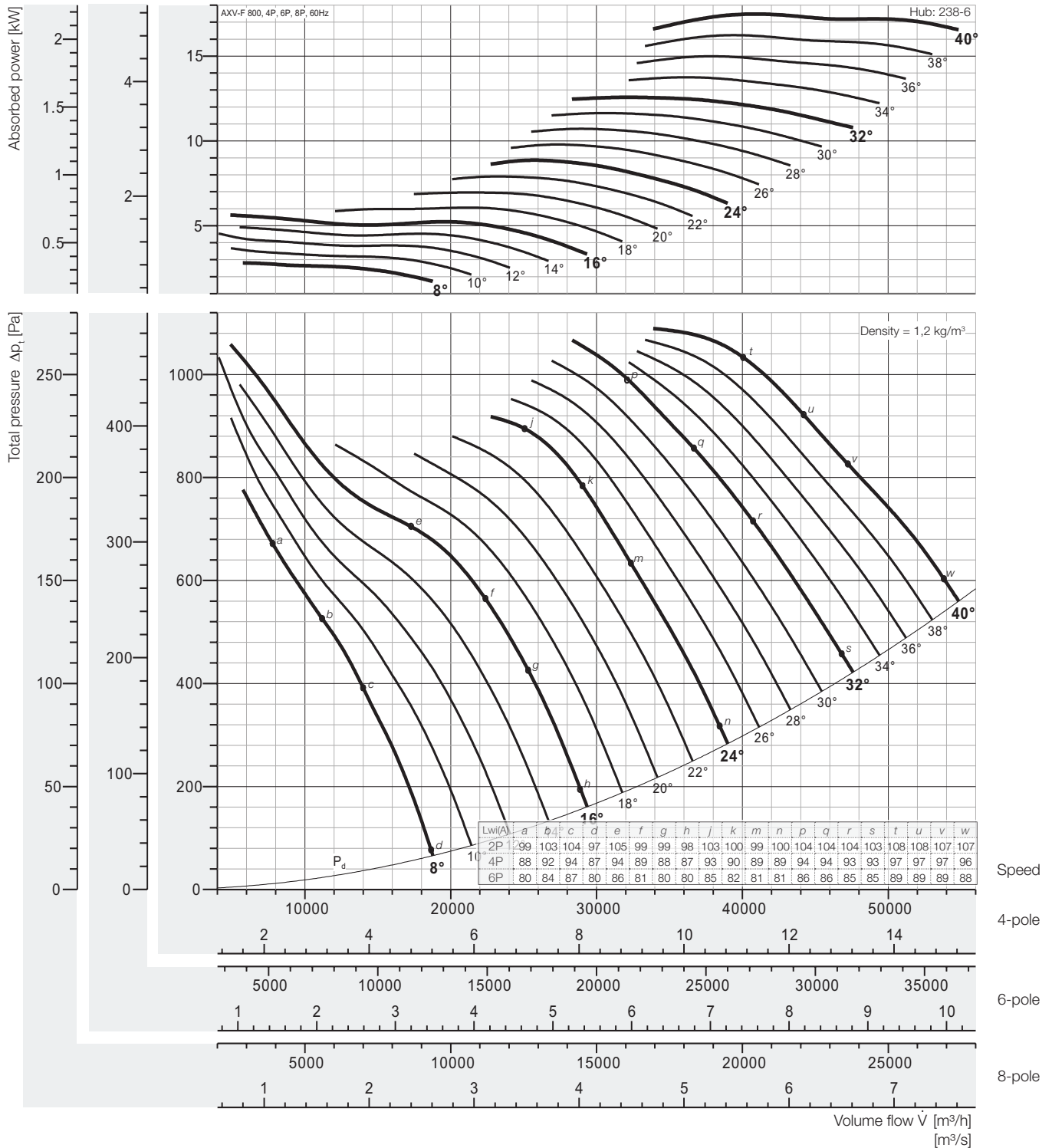

Peak absorbed power [kW]

4-pole = 1800 rpm; 6-pole = 1200 rpm; 8-pole = 900 rpm;

N Poles	Pitch angle [°]																
	8	10	12	14	16	18	20	22	24	26	28	30	32	34	36	38	40
4P motor	2,810	3,674	4,538	4,915	5,633	6,068	6,957	7,908	8,864	9,788	10,71	11,64	12,57	13,75	14,99	16,23	17,48
6P motor	0,833	1,089	1,345	1,456	1,669	1,798	2,061	2,343	2,626	2,900	3,175	3,449	3,724	4,074	4,441	4,809	5,178
8P motor	0,351	0,459	0,567	0,614	0,704	0,759	0,870	0,988	1,108	1,224	1,339	1,455	1,571	1,719	1,873	2,029	2,185

Fan test laboratory AMCA 210/99 Fig.12, Test Chamber. Performance certified is for installation type D - Ducted inlet, Ducted outlet. Performance ratings do not include the effects of appurtenances (accessories-belt cover, pulley & belt). Power rating (kW) does not include transmission losses.

The A-weighted sound ratings shown have been calculated per AMCA International Standard 301. Values shown are for inlet Lw(A) sound power levels for installation Type D: ducted inlet, ducted outlet. Ratings include the effects of duct end correction.



Performance Curve

AXV-F 900, 60 Hz

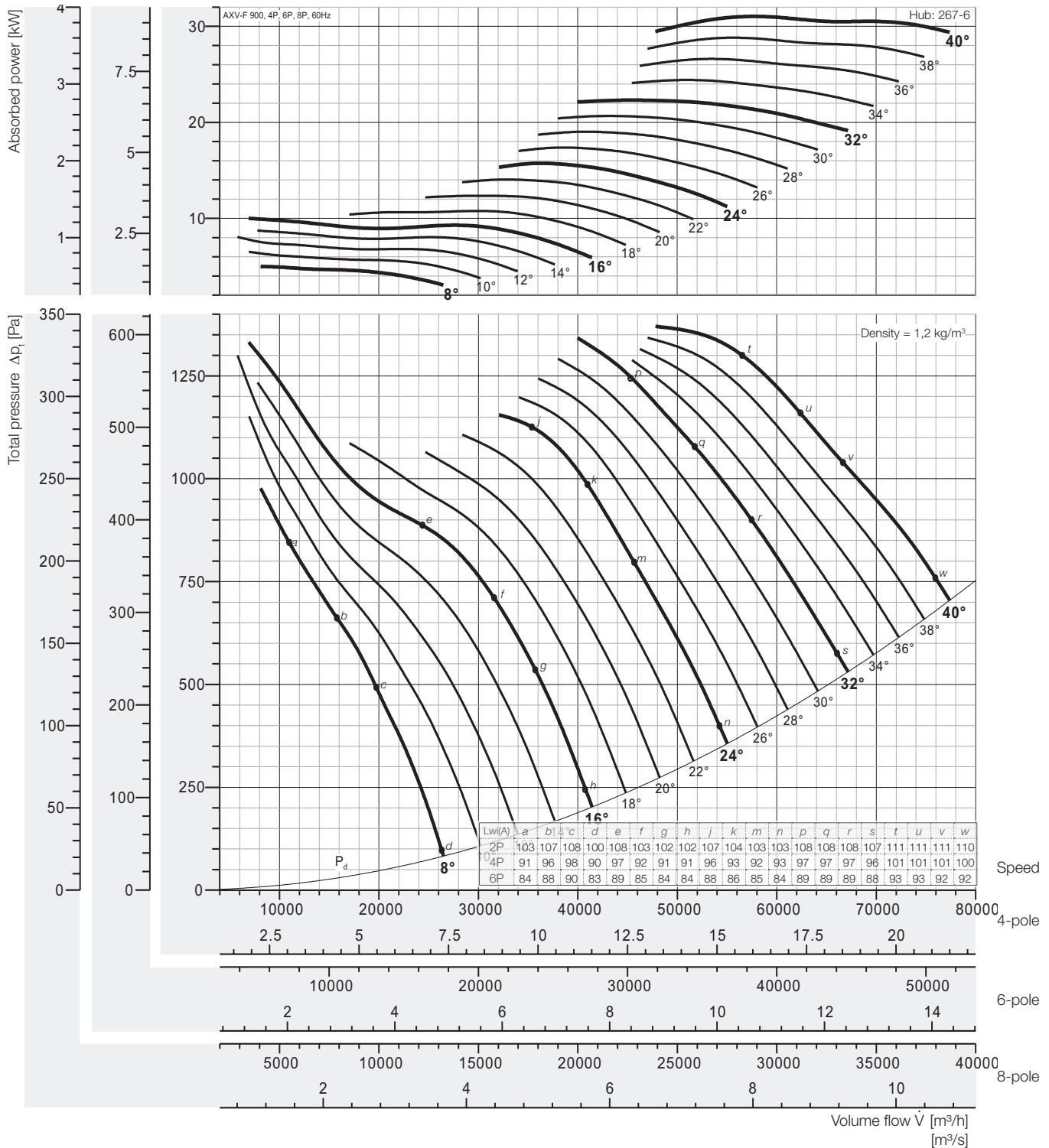

Peak absorbed power [kW]

4-pole = 1800 rpm; 6-pole = 1200 rpm; 8-pole = 900 rpm;

N Poles	Pitch angle [°]																
	8	10	12	14	16	18	20	22	24	26	28	30	32	34	36	38	40
4P motor	4,990	6,524	8,058	8,726	10,00	10,77	12,35	14,04	15,74	17,38	19,02	20,67	22,32	24,41	26,61	28,82	31,03
6P motor	1,478	1,933	2,388	2,585	2,963	3,192	3,660	4,160	4,663	5,149	5,636	6,124	6,612	7,234	7,884	8,538	9,194
8P motor	0,624	0,815	1,007	1,091	1,250	1,347	1,544	1,755	1,967	2,172	2,378	2,584	2,789	3,052	3,326	3,602	3,879

Fan test laboratory AMCA 210/99 Fig.12, Test Chamber. Performance certified is for installation type D - Ducted inlet, Ducted outlet. Performance ratings do not include the effects of appurtenances (accessories-belt cover, pulley & belt). Power rating (kW) does not include transmission losses.

The A-weighted sound ratings shown have been calculated per AMCA International Standard 301. Values shown are for inlet Lw(A) sound power levels for installation Type D: ducted inlet, ducted outlet. Ratings include the effects of duct end correction.

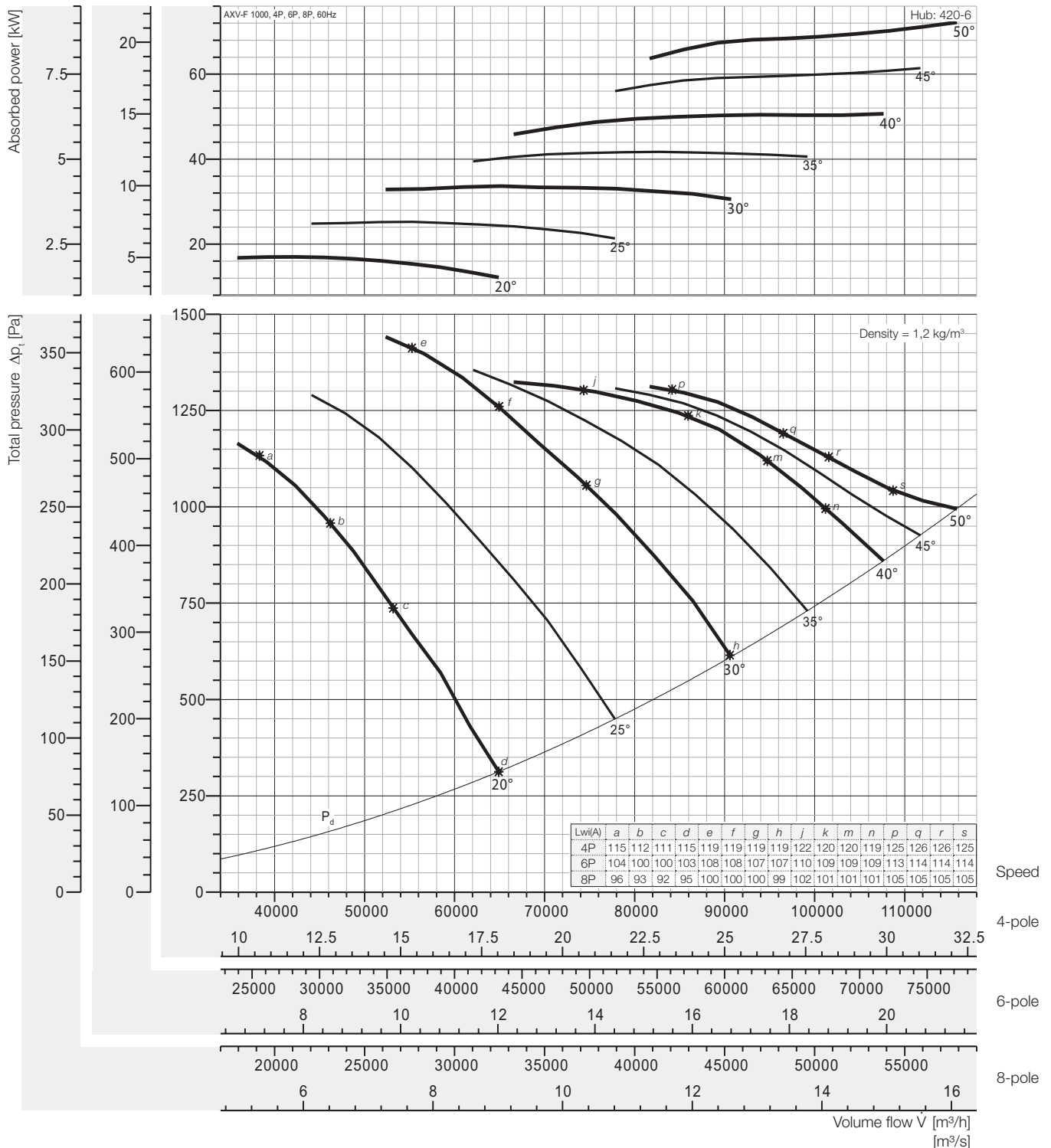

Peak absorbed power [kW]

4-pole = 1800 rpm; 6-pole = 1200 rpm; 8-pole = 900 rpm;

N Poles	Pitch angle [°]						
	20	25	30	35	40	45	50
4P	17,03	25,25	33,68	41,75	50,67	61,43	72,19
motor	18,5	30	37	45	55	75	
6P	5,045	7,482	9,980	12,37	15,01	18,20	21,39
motor	5,5	7,5	11	15	18,5		22
8P	2,128	3,156	4,210	5,219	6,333	7,678	9,023
motor	2,2	4	5,5		7,5	11	

Fan test laboratory AMCA 210/99 Fig.12, Test Chamber. Performance certified is for installation type D - Ducted inlet, Ducted outlet. Performance ratings do not include the effects of appurtenances (accessories-belt cover, pulley & belt). Power rating (kW) does not include transmission losses.

The A-weighted sound ratings shown have been calculated per AMCA International Standard 301. Values shown are for inlet Lw(A) sound power levels for installation Type D: ducted inlet, ducted outlet. Ratings include the effects of duct end correction.



Performance Curve

AXV-F 1120, 60 Hz

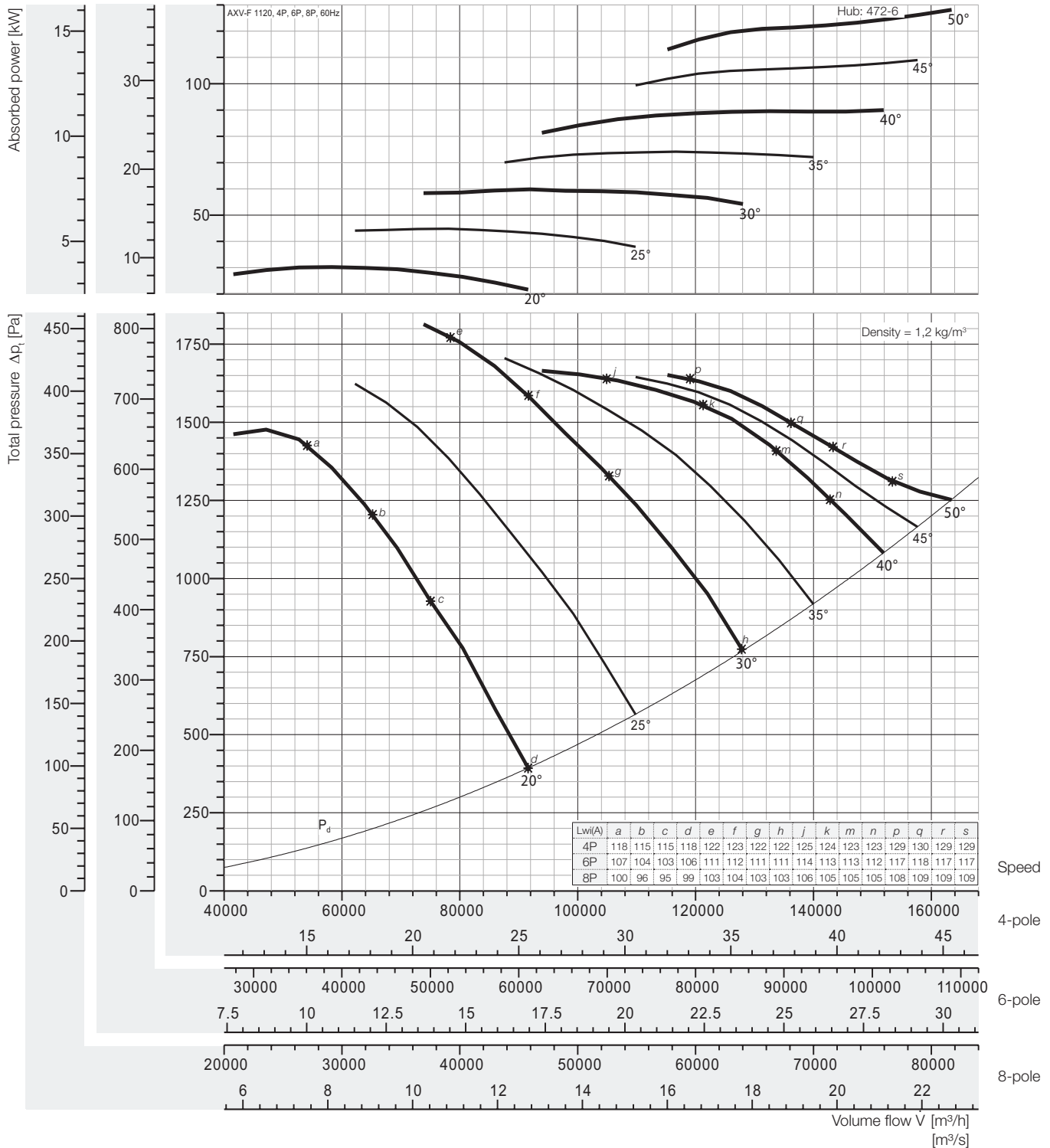

Peak absorbed power [kW]

4-pole = 1800 rpm; 6-pole = 1200 rpm; 8-pole = 900 rpm;

N Poles	Pitch angle [°]						
	20	25	30	35	40	45	50
4P motor	30,25	44,83	59,80	74,12	89,94	109,0	128,1
	37	45	75		90	110	132
6P motor	8,964	13,28	17,72	21,96	26,65	32,31	37,97
	11	15	18,5	22	30	37	45
8P motor	3,782	5,603	7,475	9,265	11,24	13,63	16,02
	4	7,5		11	15		18,5

Fan test laboratory AMCA 210/99 Fig.12, Test Chamber. Performance certified is for installation type D - Ducted inlet, Ducted outlet. Performance ratings do not include the effects of appurtenances (accessories-belt cover, pulley & belt). Power rating (kW) does not include transmission losses.

The A-weighted sound ratings shown have been calculated per AMCA International Standard 301. Values shown are for inlet Lw(A) sound power levels for installation Type D: ducted inlet, ducted outlet. Ratings include the effects of duct end correction.

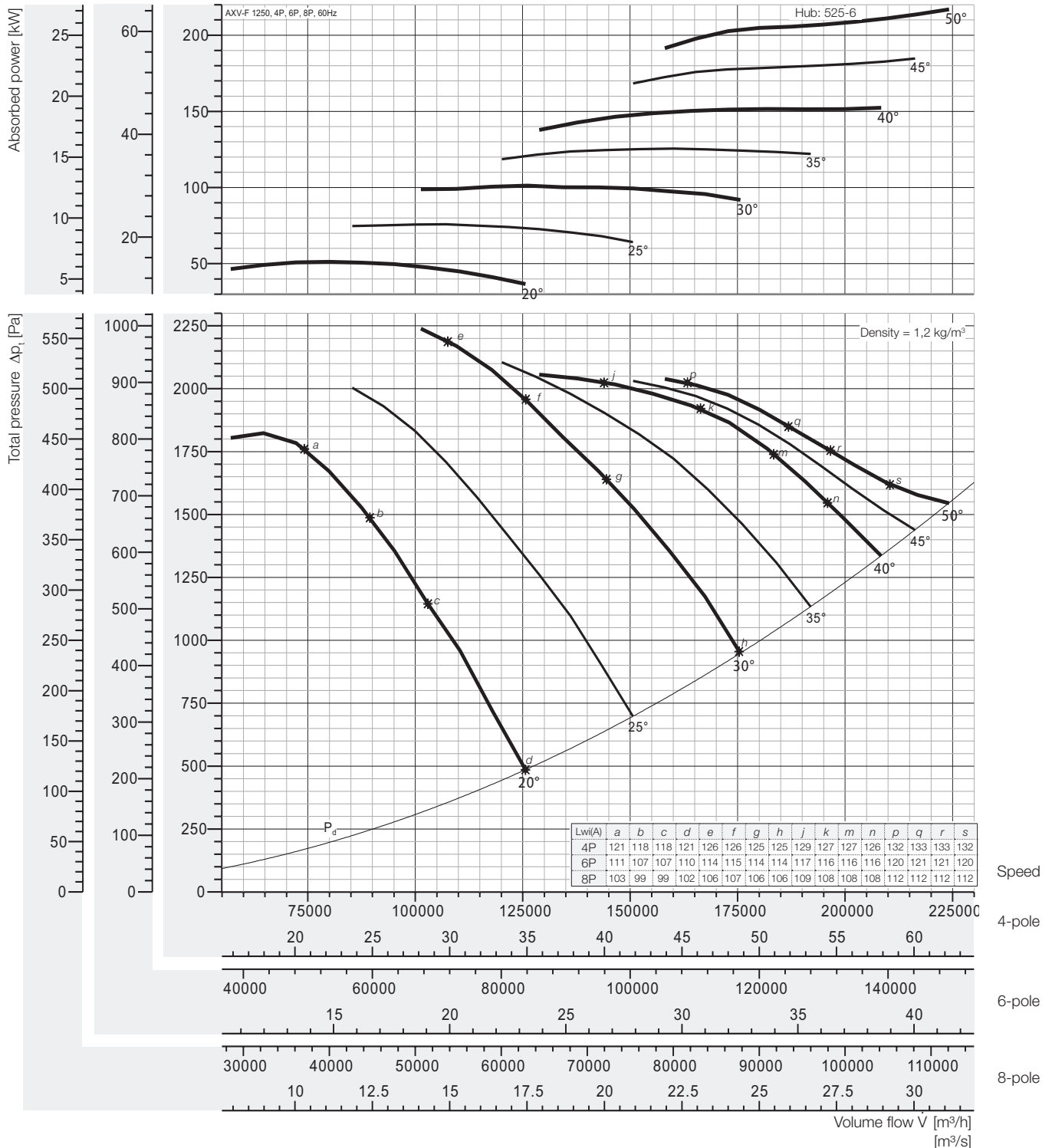

Peak absorbed power [kW]

4-pole = 1800 rpm; 6-pole = 1200 rpm; 8-pole = 900 rpm;

N Poles	Pitch angle [°]						
	20	25	30	35	40	45	50
4P motor	51,23 55	75,91 90	101,3 -	125,5 -	152,3 -	184,7 -	217,0 -
6P motor	15,18 18,5	22,49 30	30,00	37,19 45	45,13 55	54,72	64,30 75
8P motor	6,404 7,5	9,489 11	12,66 15	15,69 18,5	19,04 22	23,08 30	27,13

Fan test laboratory AMCA 210/99 Fig.12, Test Chamber. Performance certified is for installation type D - Ducted inlet, Ducted outlet. Performance ratings do not include the effects of appurtenances (accessories-belt cover, pulley & belt). Power rating (kW) does not include transmission losses.

The A-weighted sound ratings shown have been calculated per AMCA International Standard 301. Values shown are for inlet Lw(A) sound power levels for installation Type D: ducted inlet, ducted outlet. Ratings include the effects of duct end correction.



Performance Curve

AXV-F 1400, 60 Hz

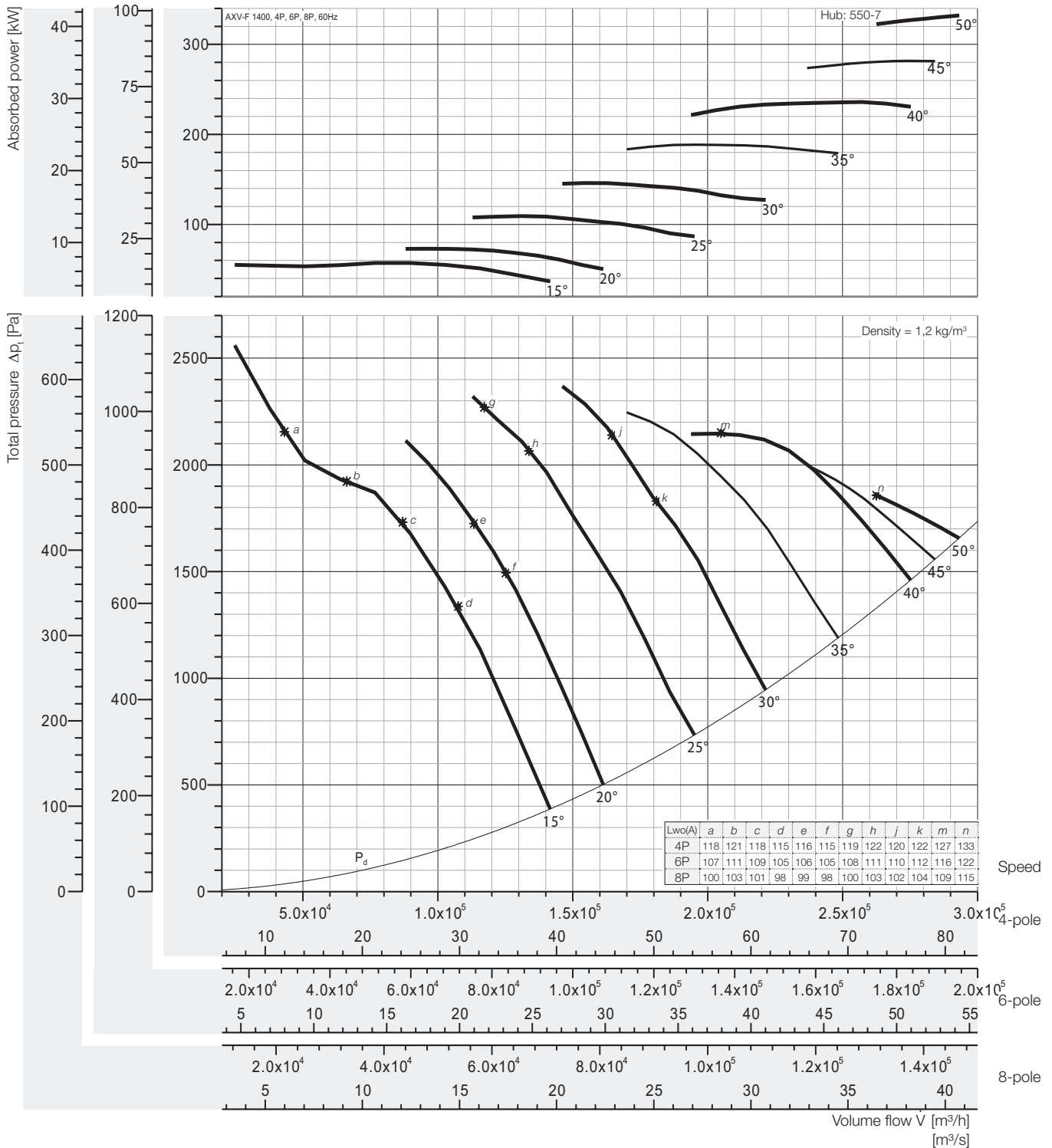

Peak absorbed power [kW]

4-pole = 1800 rpm; 6-pole = 1200 rpm; 8-pole = 900 rpm;

N Poles	Pitch angle [°]							
	15	20	25	30	35	40	45	50
4P motor	57,26	73,06	109,3	146,0	188,7	235,9	281,8	332,3
	75		110	160	200	250	315	355
6P motor	16,97	21,65	32,39	43,27	55,91	69,89	83,49	98,46
	18,5	22	37	45	75		90	110
8P motor	7,158	9,133	13,67	18,25	23,59	29,49	35,22	41,54
	7,5	11	15	18,5	30		37	45

Fan test laboratory AMCA 210/99 Fig.15, Test Chamber. Performance certified is for installation type A - Free inlet, Free outlet. Performance ratings do not include the effects of appurtenances (accessories-belt cover, pulley & belt). Power rating (kW) does not include transmission losses.

The A-weighted sound ratings shown have been calculated per AMCA International Standard 301. Values shown are for outlet Lw_oA sound power levels for installation Type A: free inlet, free outlet.

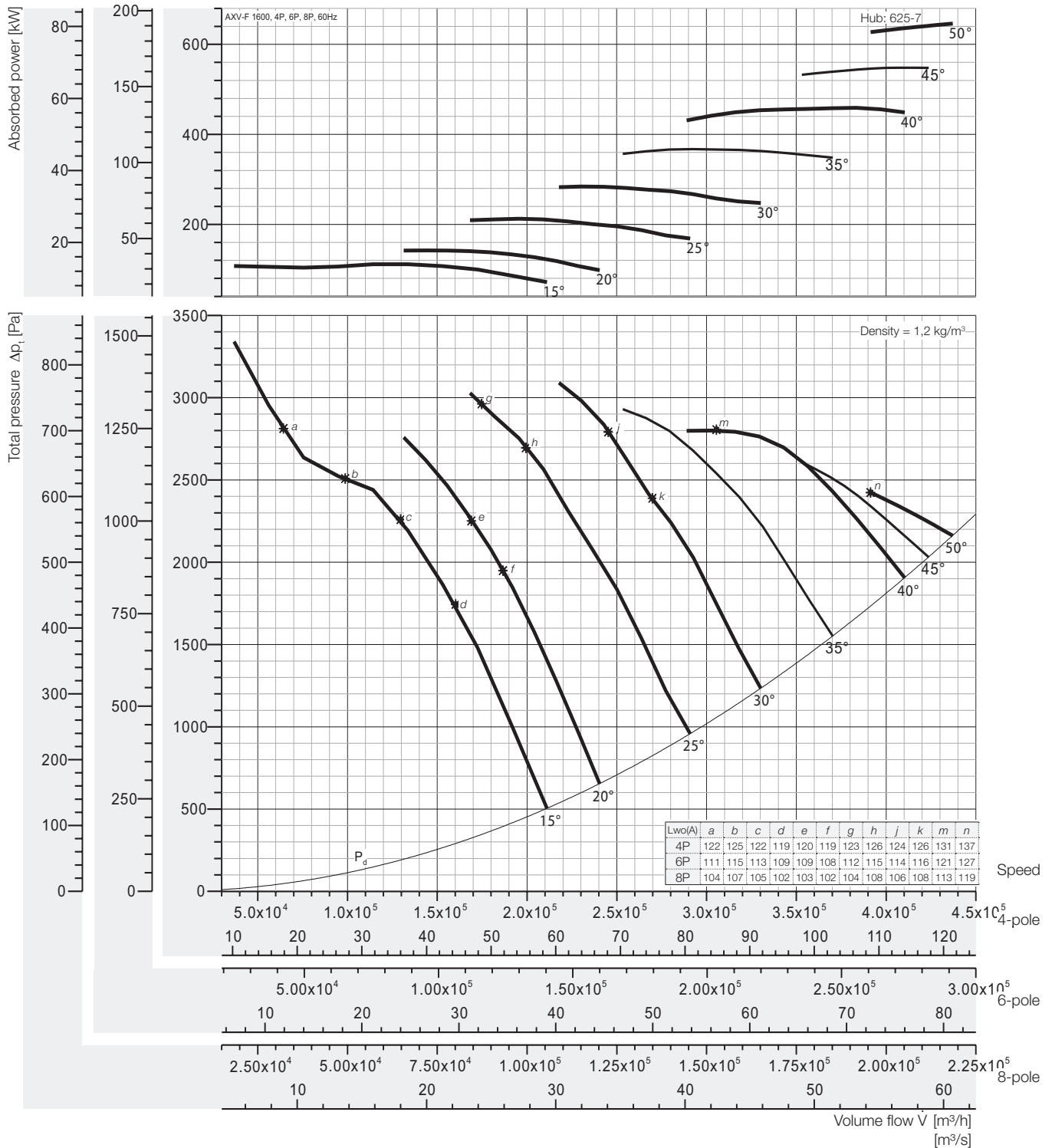

Peak absorbed power [kW]

4-pole = 1800 rpm; 6-pole = 1200 rpm; 8-pole = 900 rpm;

N Poles	Pitch angle [°]							
	15	20	25	30	35	40	45	50
4P motor	111,4	142,1	212,7	284,1	367,1	458,9	548,2	646,4
6P motor	33,01	42,11	63,01	84,17	108,8	136,0	162,4	191,5
8P motor	13,92	17,77	26,58	35,51	45,89	57,36	68,52	80,80

Fan test laboratory AMCA 210/99 Fig.15, Test Chamber. Performance certified is for installation type A - Free inlet, Free outlet. Performance ratings do not include the effects of appurtenances (accessories-belt cover, pulley & belt). Power rating (kW) does not include transmission losses.

The A-weighted sound ratings shown have been calculated per AMCA International Standard 301. Values shown are for outlet LwoA sound power levels for installation Type A: free inlet, free outlet.



Performance Curve

AXV-F 1800, 60 Hz

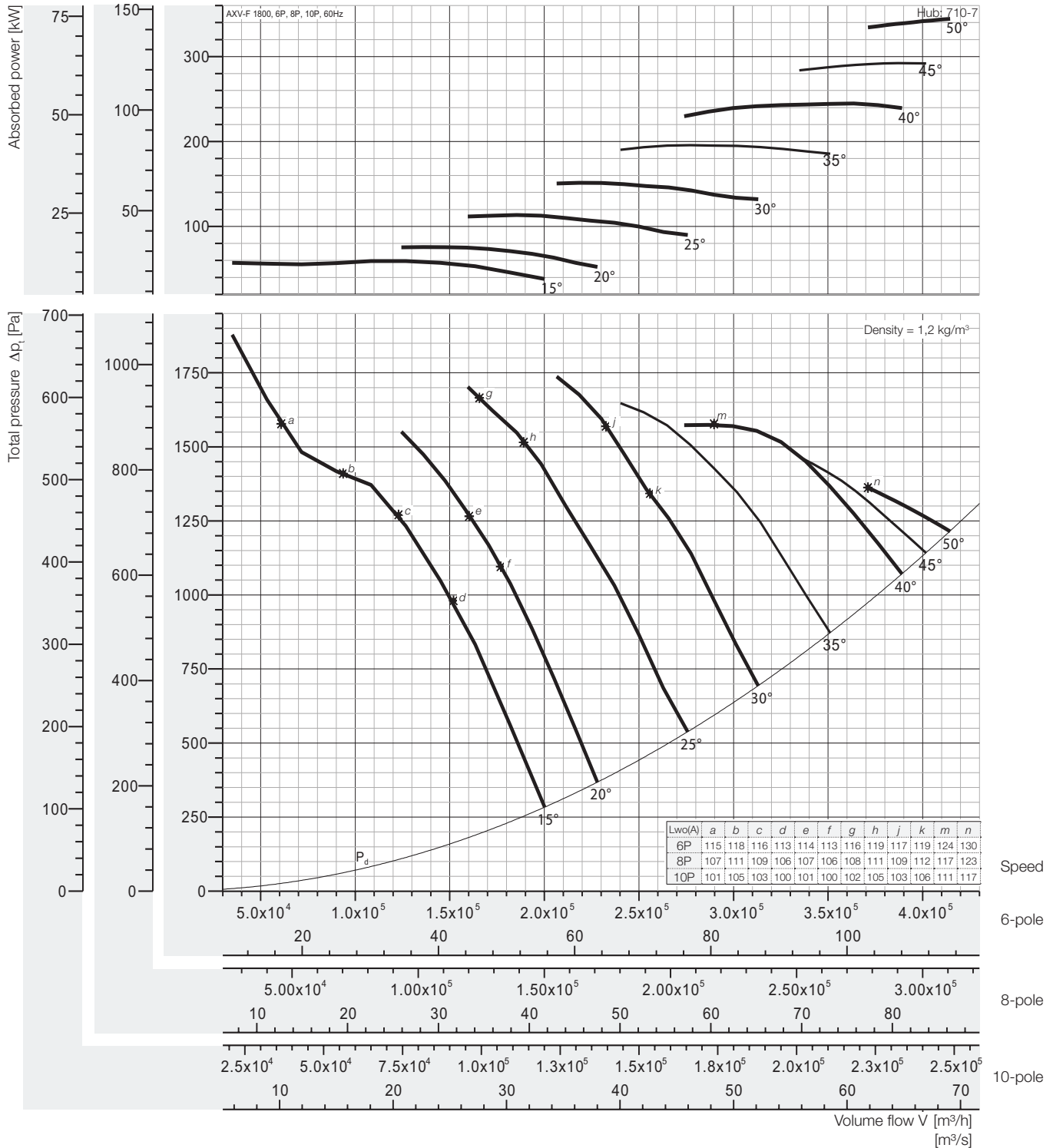

Peak absorbed power [kW]

6-pole = 1200 rpm; 8-pole = 900 rpm; 10-pole = 720 rpm;

N Poles	Pitch angle [°]							
	15	20	25	30	35	40	45	50
6P motor	59,37	75,76	113,3	151,4	195,7	244,6	292,2	344,5
8P motor	25,05	31,96	47,82	63,88	82,55	103,2	123,3	145,3
10P motor	12,82	16,36	24,49	32,70	42,26	52,83	63,11	74,42

Fan test laboratory AMCA 210/99 Fig.15, Test Chamber. Performance certified for installation type A - Free inlet, Free outlet. Performance ratings do not include the effects of appurtenances (accessories-belt cover, pulley & belt). Power rating (kW) does not include transmission losses.

The A-weighted sound ratings shown have been calculated per AMCA International Standard 301. Values shown are for outlet L_{w0}A sound power levels for installation Type A: free inlet, free outlet.

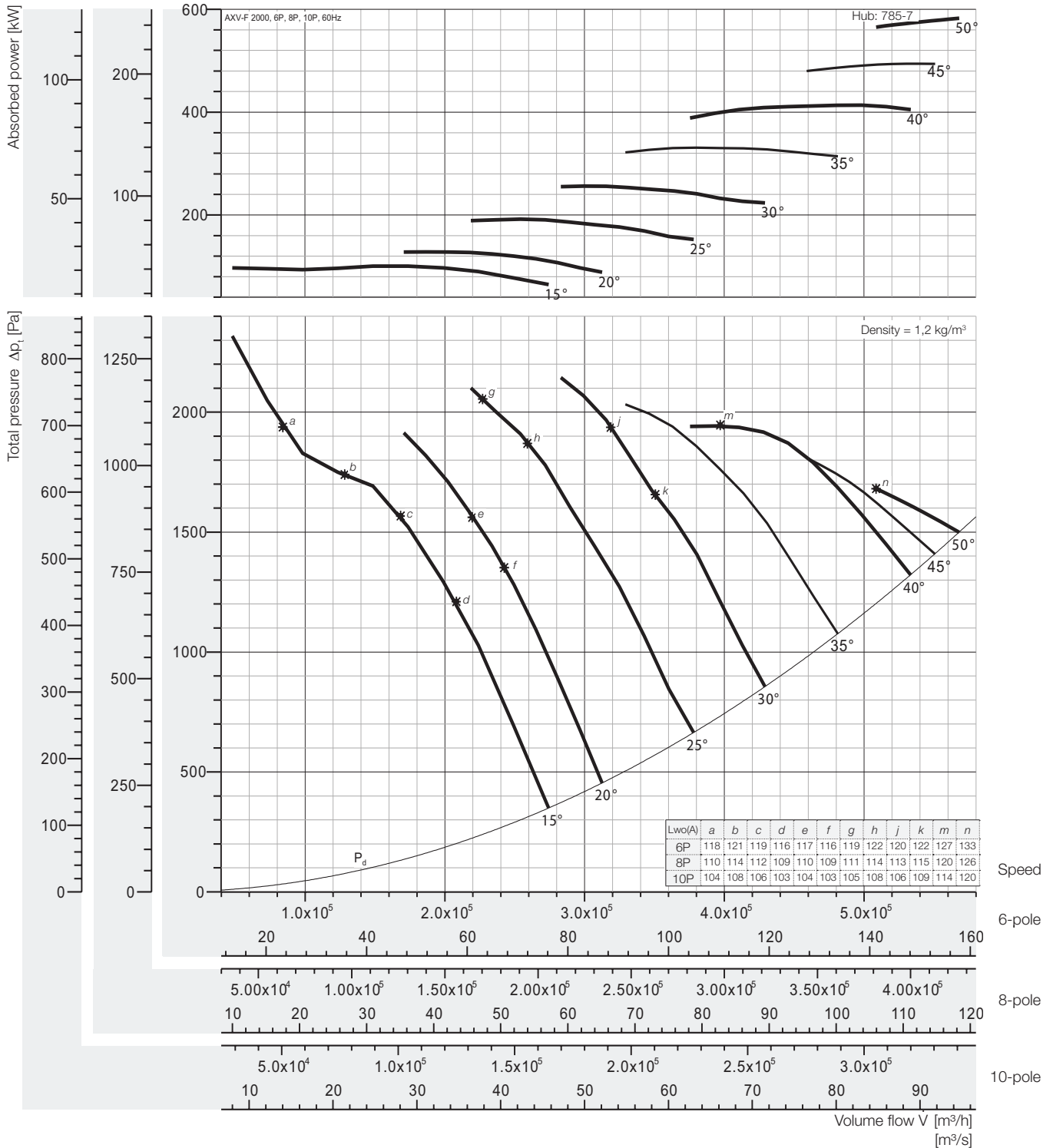

Peak absorbed power [kW]

6-pole = 1200 rpm; 8-pole = 900 rpm; 10-pole = 720 rpm;

N Poles	Pitch angle [°]							
	15	20	25	30	35	40	45	50
6P motor	100,4	128,1	191,7	256,1	330,9	413,6	494,1	582,7
8P motor	42,36	54,05	80,88	108,0	139,6	174,5	208,4	245,8
10P motor	21,69	27,67	41,41	55,31	71,47	89,35	106,7	125,9

Fan test laboratory AMCA 210/99 Fig.15, Test Chamber. Performance certified is for installation type A - Free inlet, Free outlet. Performance ratings do not include the effects of appurtenances (accessories-belt cover, pulley & belt). Power rating (kW) does not include transmission losses.

The A-weighted sound ratings shown have been calculated per AMCA International Standard 301. Values shown are for outlet LwoA sound power levels for installation Type A: free inlet, free outlet.



Performance Curve

AXV-F 2200, 60 Hz

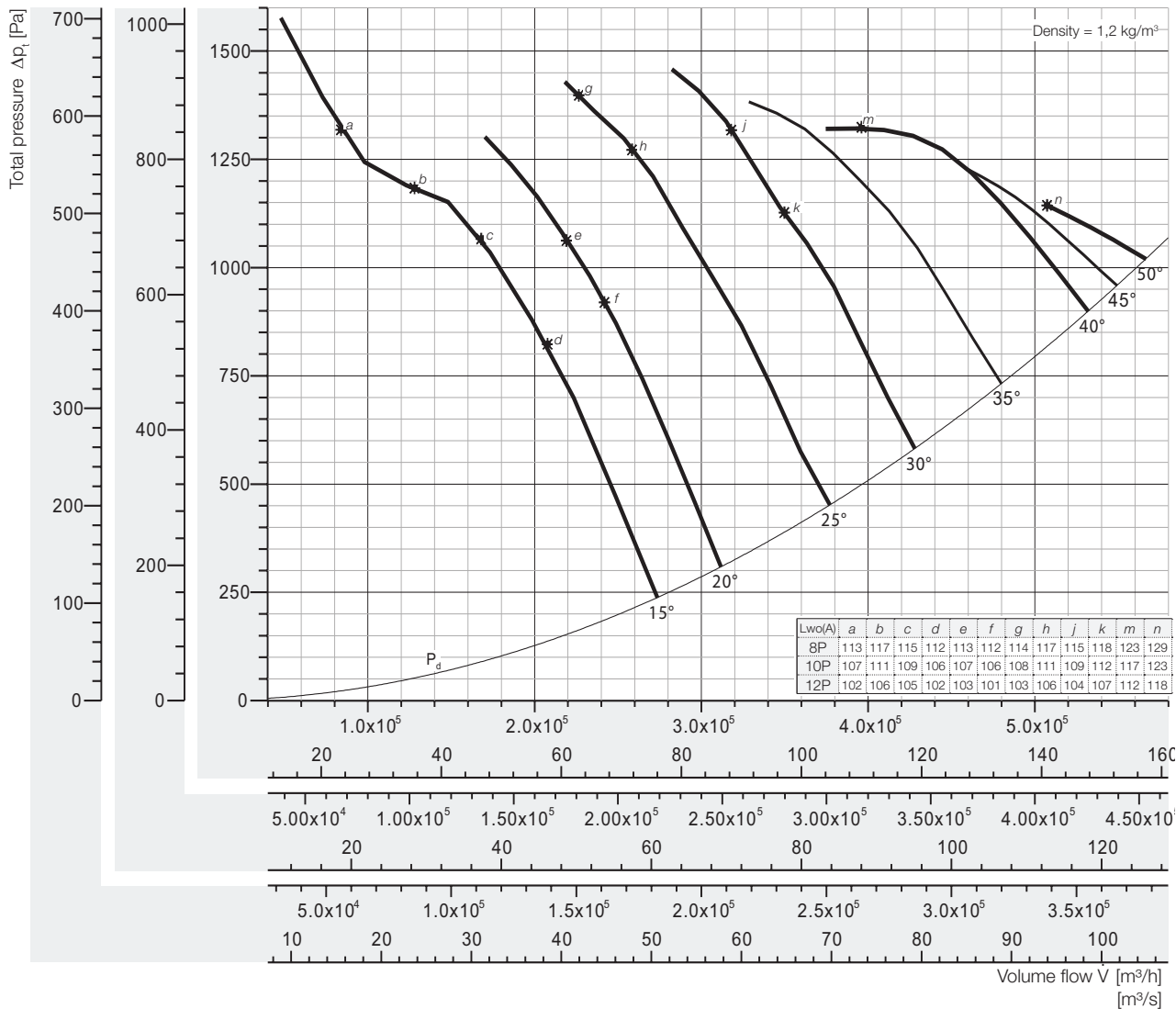
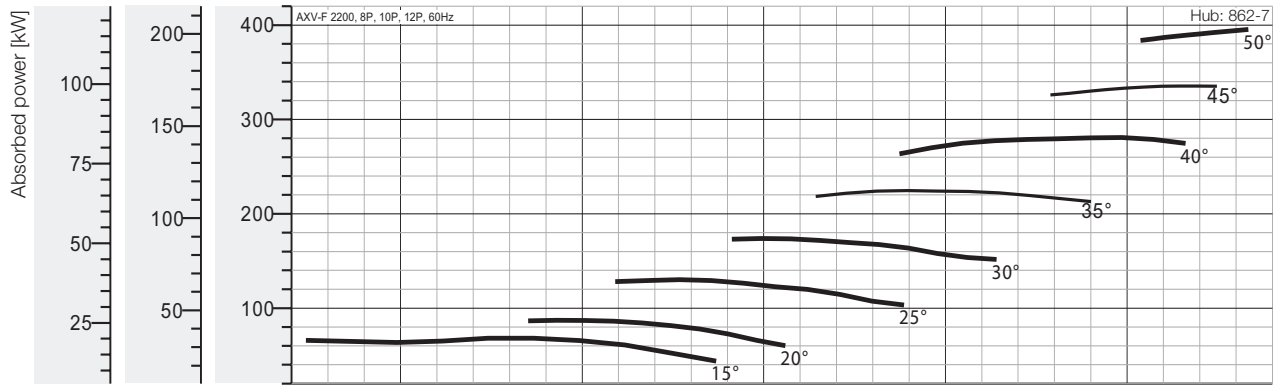

Peak absorbed power [kW]

8-pole = 900 rpm; 10-pole = 720 rpm; 12-pole = 600 rpm;

N Poles	Pitch angle [°]							
	15	20	25	30	35	40	45	50
8P motor	68,45 75	86,95 90	130,1 132	173,8 200	224,6 250	280,7 315	335,3 355	395,4 400
10P motor	34,89 37	44,52 45	66,61 75	88,97 90	115,0 132	143,7 160	171,7 200	202,5 250
12P motor	20,19 22	25,76 30	38,55 45	51,49 55	66,54 75	83,18 90	99,36 110	117,2 132

Fan test laboratory AMCA 210/99 Fig.15, Test Chamber. Performance certified for installation type A - Free inlet, Free outlet. Performance ratings do not include the effects of appurtenances (accessories-belt cover, pulley & belt). Power rating (kW) does not include transmission losses.

The A-weighted sound ratings shown have been calculated per AMCA International Standard 301. Values shown are for outlet Lw0A sound power levels for installation Type A: free inlet, free outlet.

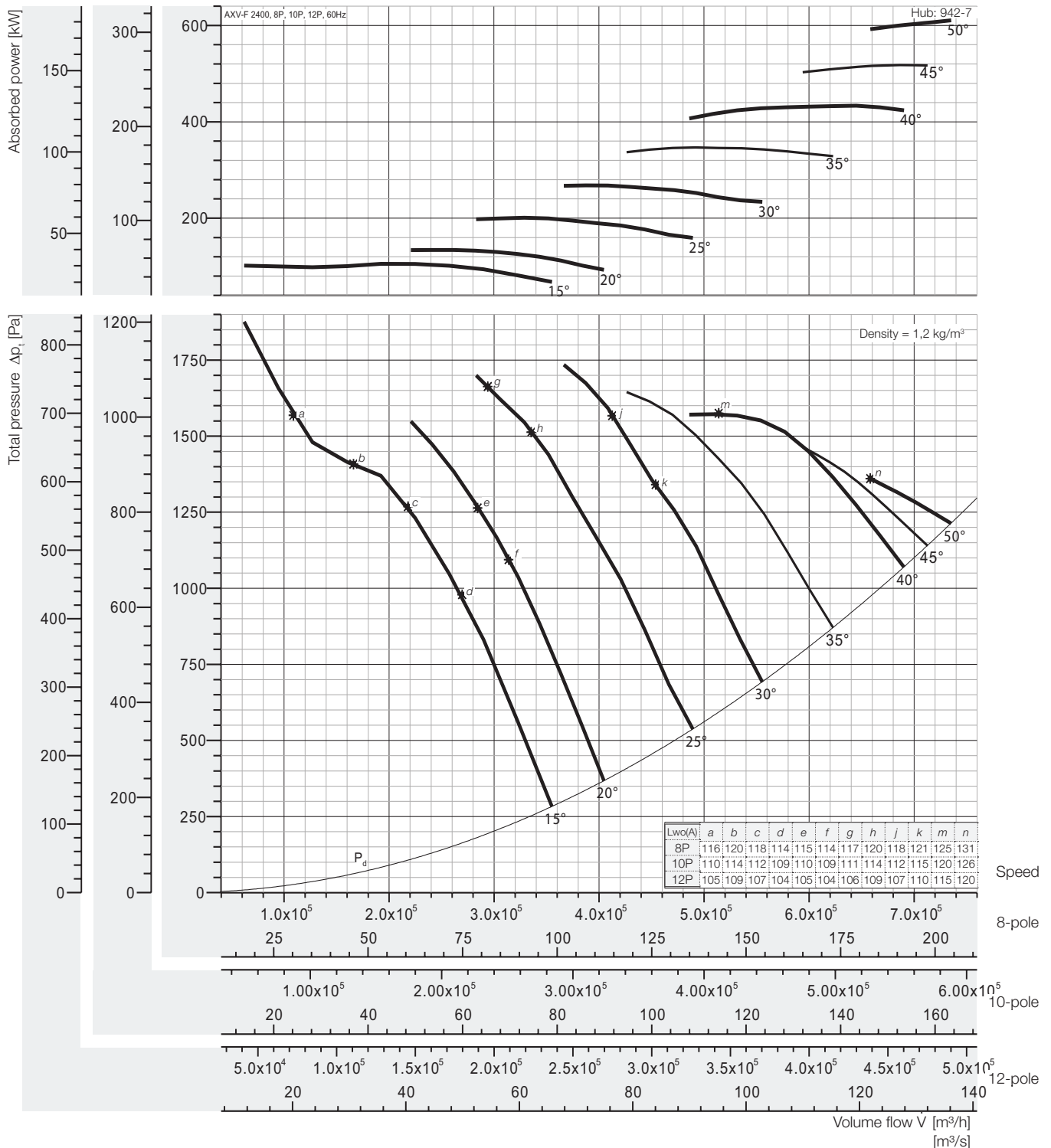

Peak absorbed power [kW]

8-pole = 900 rpm; 10-pole = 720 rpm; 12-pole = 600 rpm;

N Poles	Pitch angle [°]							
	15	20	25	30	35	40	45	50
8P motor	105,2 110	134,2 160	200,8 250	268,2 315	346,6 355	433,3 450	517,6 560	610,4 630
10P motor	53,86 55	68,72 75	102,8 110	137,3 160	177,5 200	221,9 250	265,0 315	312,5
12P motor	31,17 37	39,77 45	59,50 75	79,48 90	102,7 110	128,4 132	153,4 160	180,9 200

Fan test laboratory AMCA 210/99 Fig.15, Test Chamber. Performance certified is for installation type A - Free inlet, Free outlet. Performance ratings do not include the effects of appurtenances (accessories-belt cover, pulley & belt). Power rating (kW) does not include transmission losses.

The A-weighted sound ratings shown have been calculated per AMCA International Standard 301. Values shown are for outlet LwoA sound power levels for installation Type A: free inlet, free outlet.



Performance Curve

AXV-F 2500, 60 Hz

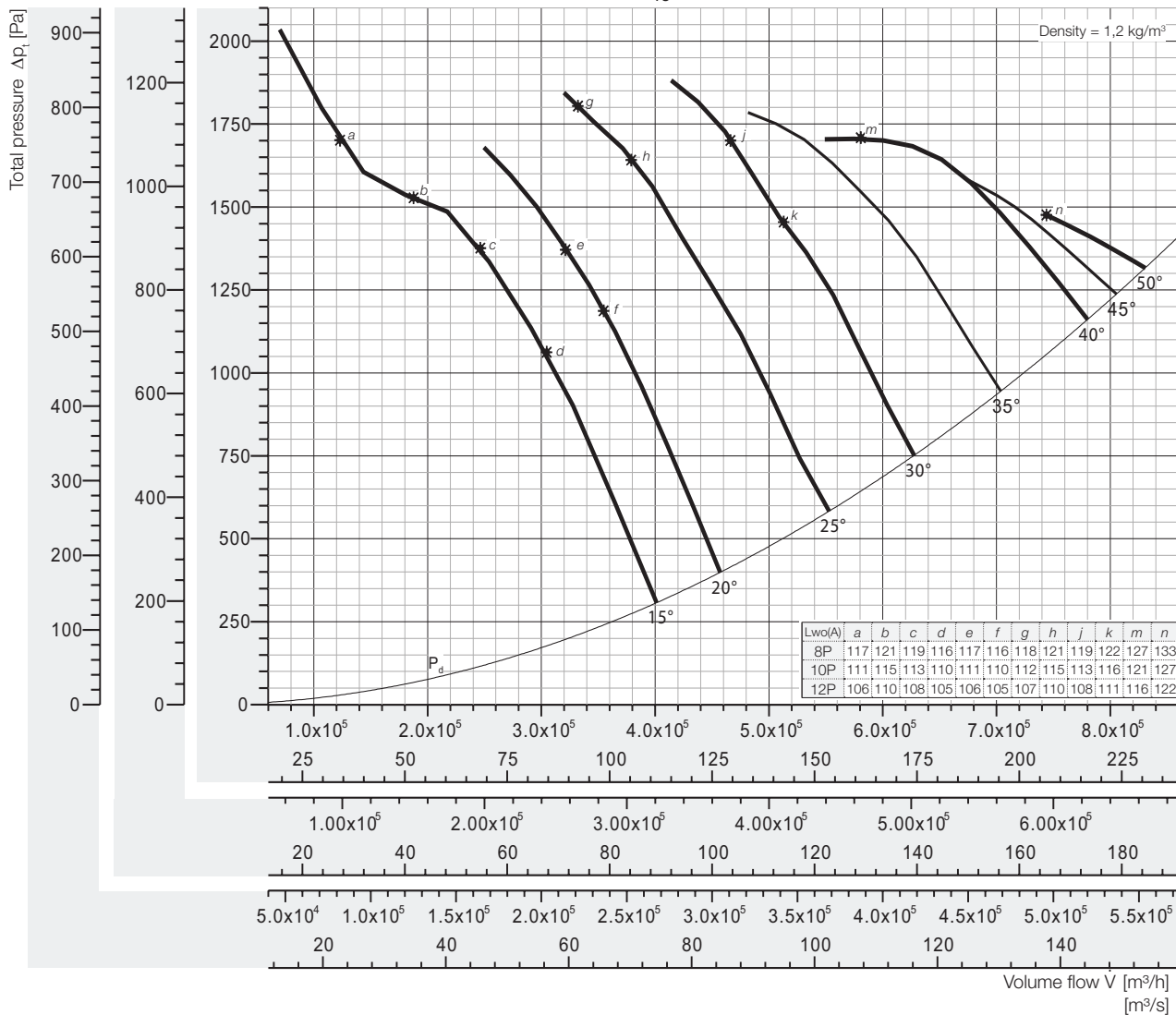
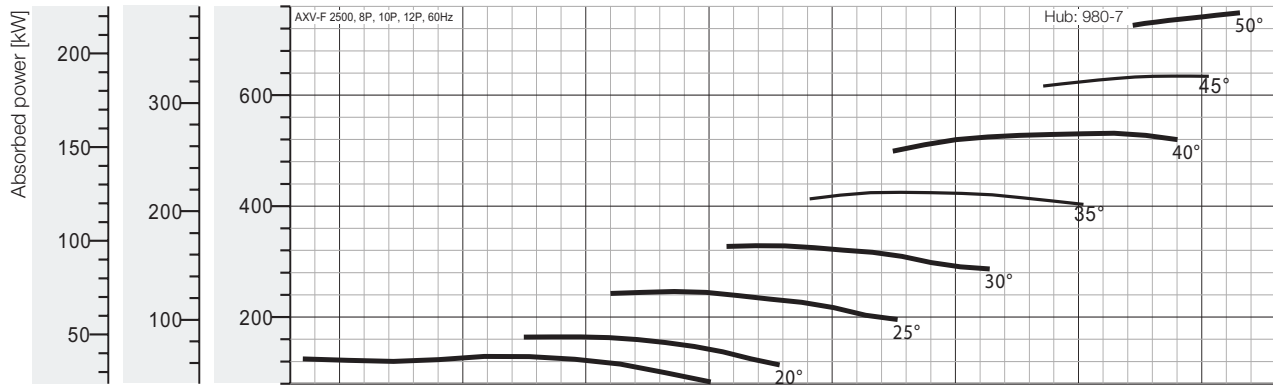

Speed
8-pole
10-pole
12-pole

Peak absorbed power [kW]

8-pole = 900 rpm; 10-pole = 720 rpm; 12-pole = 600 rpm;

N Poles	Pitch angle [°]							
	15	20	25	30	35	40	45	50
8P motor	128,9 132	164,5 200	246,2 250	328,8 355	425,0 450	531,2 560	634,6 710	748,3 -
10P motor	66,02 75	84,24 90	126,0 132	168,4 200	217,6 250	272,0 315	324,9 355	383,1 400
12P motor	38,21 45	48,75 55	72,95 75	97,43 110	125,9 132	157,4 160	188,0 200	221,7 250

Fan test laboratory AMCA 210/99 Fig.15, Test Chamber. Performance certified for installation type A - Free inlet, Free outlet. Performance ratings do not include the effects of appurtenances (accessories-belt cover, pulley & belt). Power rating (kW) does not include transmission losses.

The A-weighted sound ratings shown have been calculated per AMCA International Standard 301. Values shown are for outlet Lw0A sound power levels for installation Type A: free inlet, free outlet.

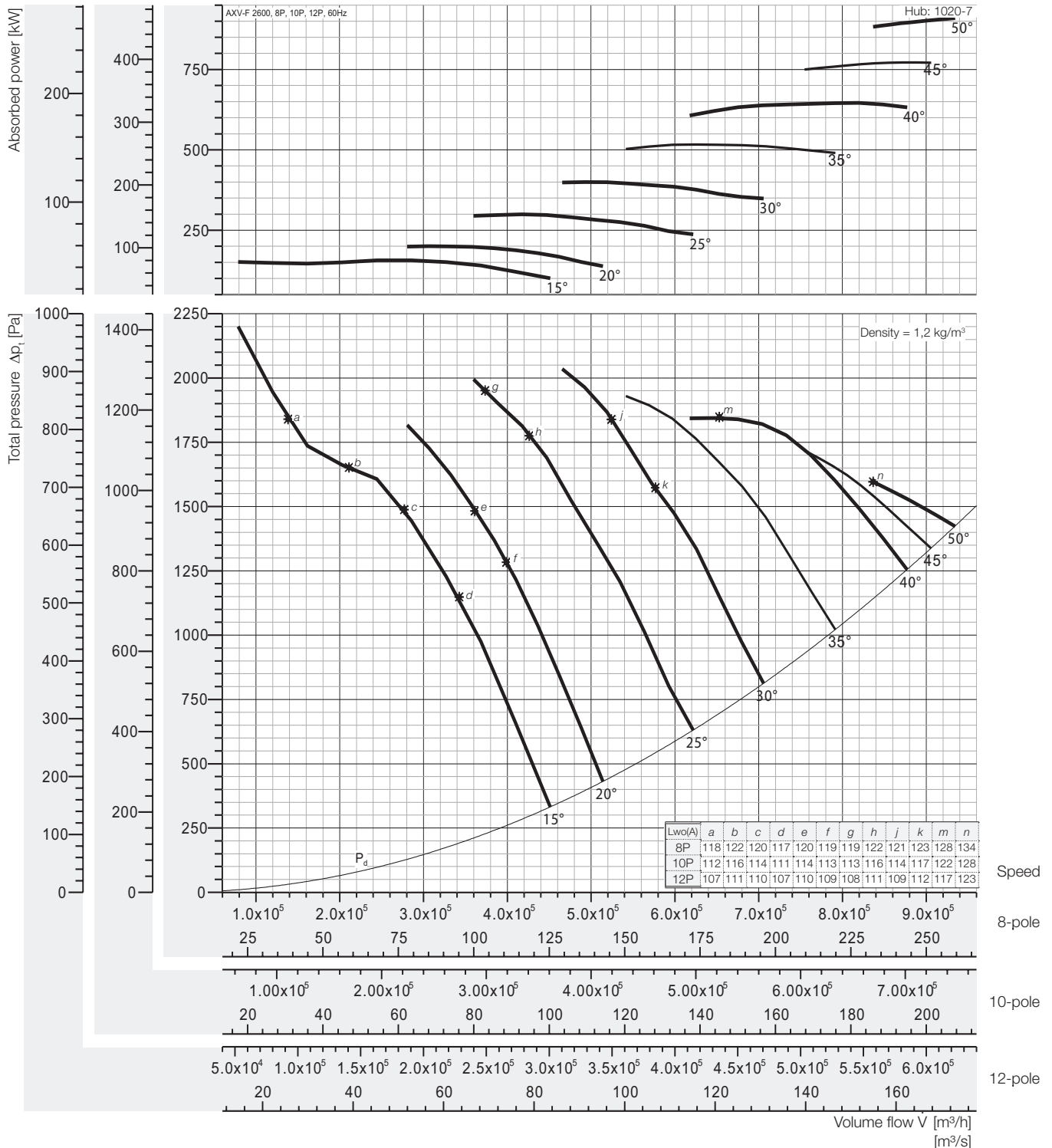

Peak absorbed power [kW]

8-pole = 900 rpm; 10-pole = 720 rpm; 12-pole = 600 rpm;

N Poles	Pitch angle [°]							
	15	20	25	30	35	40	45	50
8P motor	156,8	200,1	299,4	399,9	516,8	646,1	771,8	910,1
	160	250	315	400	560	710	-	-
10P motor	80,30	102,4	153,3	204,8	264,6	330,8	395,1	466,0
	90	110	160	250	315	355	400	500
12P motor	46,47	59,29	88,72	118,5	153,1	191,4	228,7	269,6
	55	75	90	132	160	200	250	315

Fan test laboratory AMCA 210/99 Fig.15, Test Chamber. Performance certified is for installation type A - Free inlet, Free outlet. Performance ratings do not include the effects of appurtenances (accessories-belt cover, pulley & belt). Power rating (kW) does not include transmission losses.

The A-weighted sound ratings shown have been calculated per AMCA International Standard 301. Values shown are for outlet LwoA sound power levels for installation Type A: free inlet, free outlet.



Performance Curve

AXV-F 2800, 60 Hz

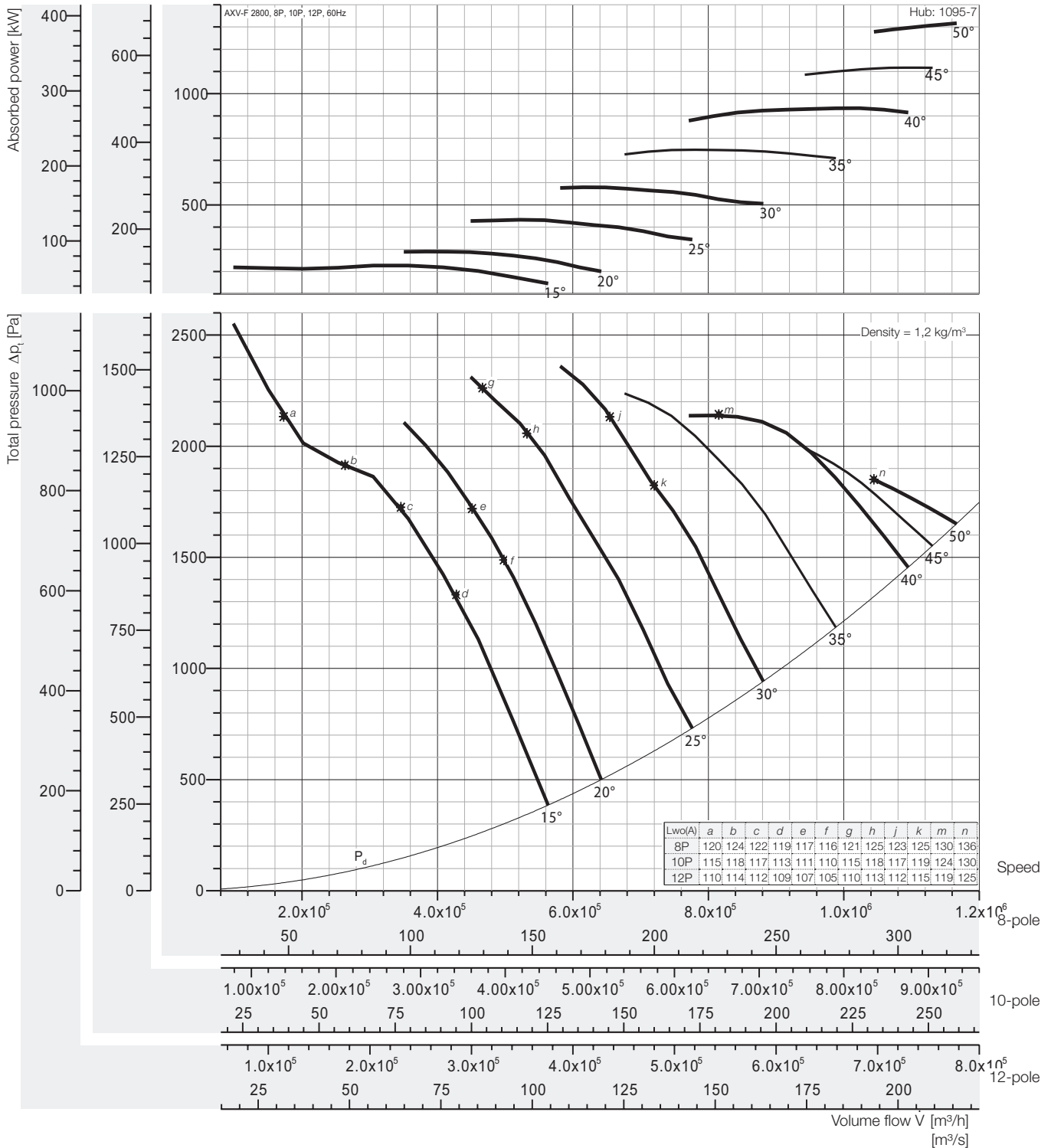

Peak absorbed power [kW]

8-pole = 900 rpm; 10-pole = 720 rpm; 12-pole = 600 rpm;

N Poles	Pitch angle [°]							
	15	20	25	30	35	40	45	50
8P motor	227,0 250	289,6 315	433,4 450	578,9 630	748,1 -	935,2 -	1117 -	1317 -
10P motor	116,2 132	148,3 160	221,9 250	296,4 315	383,0 400	478,8 500	572,0 630	674,5 710
12P motor	67,26 75	85,82 90	128,4 132	171,5 200	221,7 250	277,1 315	331,0 355	390,3 400

Fan test laboratory AMCA 210/99 Fig.15, Test Chamber. Performance certified for installation type A - Free inlet, Free outlet. Performance ratings do not include the effects of appurtenances (accessories-belt cover, pulley & belt). Power rating (kW) does not include transmission losses.

The A-weighted sound ratings shown have been calculated per AMCA International Standard 301. Values shown are for outlet LwoA sound power levels for installation Type A: free inlet, free outlet.

Vane Axial Flow Fans

Dimensions



Direct Driven

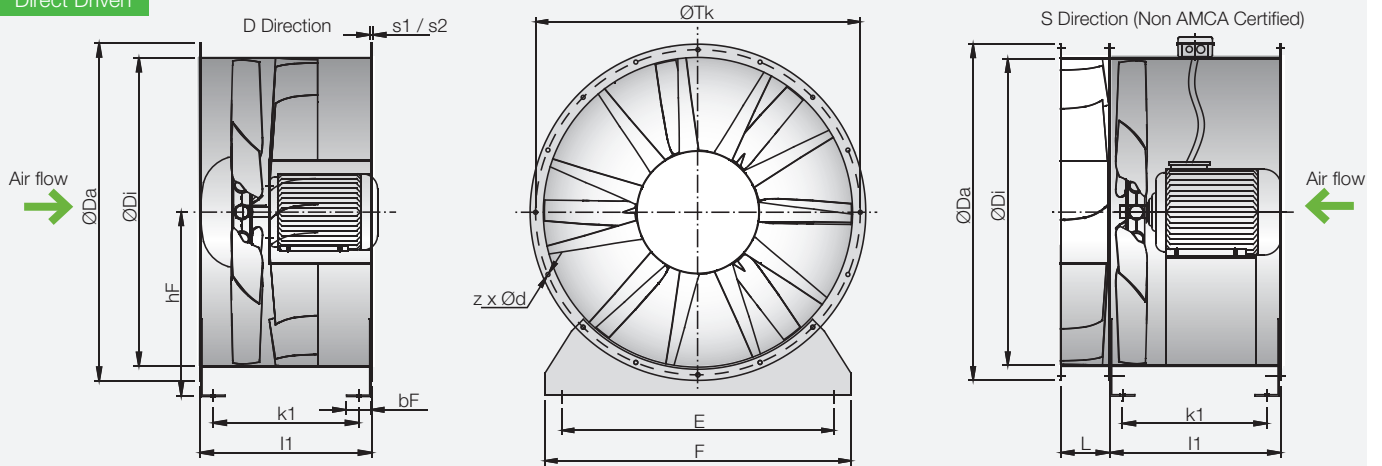

Belt Driven

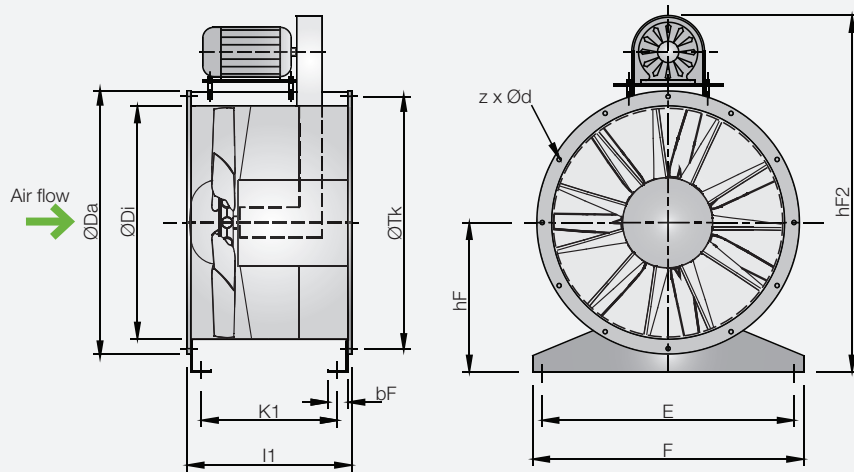

Model size	Da [mm]	Di [mm]	hF [mm]	hF2 [mm]	z x d [mm]	Tk [mm]	E [mm]	F [mm]	L [mm]	bF [mm]
500	584	504	315	910	12 x 12	551	440	500	140	70
560	664	565	345	998	16 x 14	629	500	560	150	70
630	734	634	400	1156	16 x 14	698	570	630	160	70
710	814	711	450	1300	16 x 14	775	650	710	180	70
800	904	797	500	1445	12* x 14	861	730	800	200	80
900	1004	894	580	1676	12* x 14	958	830	900	210	80
1000	1105	1003	630	1821	12* x 14	1067	930	990	280	80
1120	1245	1125	690	1990	16* x 18	1200	1050	1110	300	100
1250	1370	1250	750	2175	16* x 18	1337	1180	1240	330	100
1400	1525	1405	830	2362	16* x 18	1475	1330	1390	370	100
1600	1725	1605	930	2550	20* x 18	1675	1530	1590	420	100

LH/1 size	k1 [mm]	l1 [mm]	s1 [mm]	motor max.	s2 [mm]	motor max.	LH/2 size	k1 [mm]	l1 [mm]	s1 [mm]	motor max.	s2 [mm]	motor max.
500	326	400	2	132	2	112	560	624	700	3	160	-	-
560	326	400	2	132	2	112	630	624	700	3	160	-	-
630	326	400	2	160	2	132	710	490	565	2,5	180	-	-
710	326	400	2,5	160	2	132	800	614	700	3	180	-	-
800	326	400	2,5	160	2	132	900	612	700	4	180	3	160
900	444	530	3	225	2	200	1000	692	780	4	250	3	225
1000	444	530	3	225	2	200	1120	892	1000	4	250	3	225
1120	522	630	4	225	3	200	1250	892	1000	4	280	3	250
1250	522	630	4	250	3	225	1400	892	1000	4	315	3	280
							1600	892	1000	4	315	3	280

We reserve the right to alter measurements without notice in case of technical improvements.

Vane Axial Flow Fans

Dimensions



Bifurcated

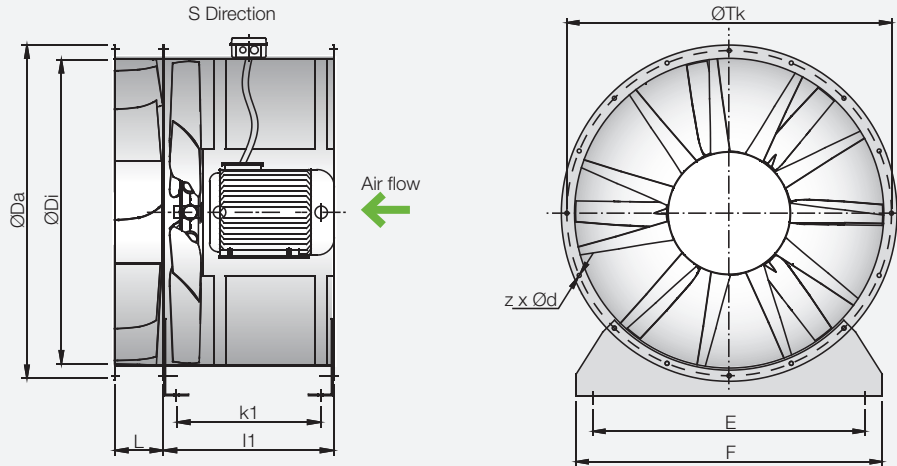

Model size	Da [mm]	Di [mm]	z x d [mm]	Tk [mm]	E [mm]	F [mm]	L [mm]
500	584	504	12 x 12	551	440	500	140
560	664	565	16 x 14	629	500	560	150
630	734	634	16 x 14	698	570	630	160
710	814	711	16 x 14	775	650	710	180
800	904	797	12* x 14	861	730	800	200
900	1004	894	12* x 14	958	830	900	210
1000	1105	1003	12* x 14	1067	930	990	280
1120	1245	1125	16* x 18	1200	1050	1110	300
1250	1370	1250	16* x 18	1337	1180	1240	330
1400	1525	1405	16* x 18	1475	1330	1390	370
1600	1725	1605	20* x 18	1675	1530	1590	420

LH/1 size	k1 [mm]	l1 [mm]	s1 [mm]	motor max.	s2 [mm]	motor max.	LH/2 size	k1 [mm]	l1 [mm]	s1 [mm]	motor max.	s2 [mm]	motor max.
500	326	400	2	132	2	112	560	624	700	3	160	-	-
560	326	400	2	132	2	112	630	624	700	3	160	-	-
630	326	400	2	160	2	132	710	490	565	2,5	180	-	-
710	326	400	2,5	160	2	132	800	614	700	3	180	-	-
800	326	400	2,5	160	2	132	900	612	700	4	180	3	160
900	444	530	3	225	2	200	1000	692	780	4	250	3	225
1000	444	530	3	225	2	200	1120	892	1000	4	250	3	225
1120	522	630	4	225	3	200	1250	892	1000	4	280	3	250
1250	522	630	4	250	3	225	1400	892	1000	4	315	3	280
							1600	892	1000	4	315	3	280

The Bifurcated Vane Axial Fan are not licensed by AMCA International.

We reserve the right to alter measurements without notice in case of technical improvements.

Vane Axial Flow Fans

Dimensions

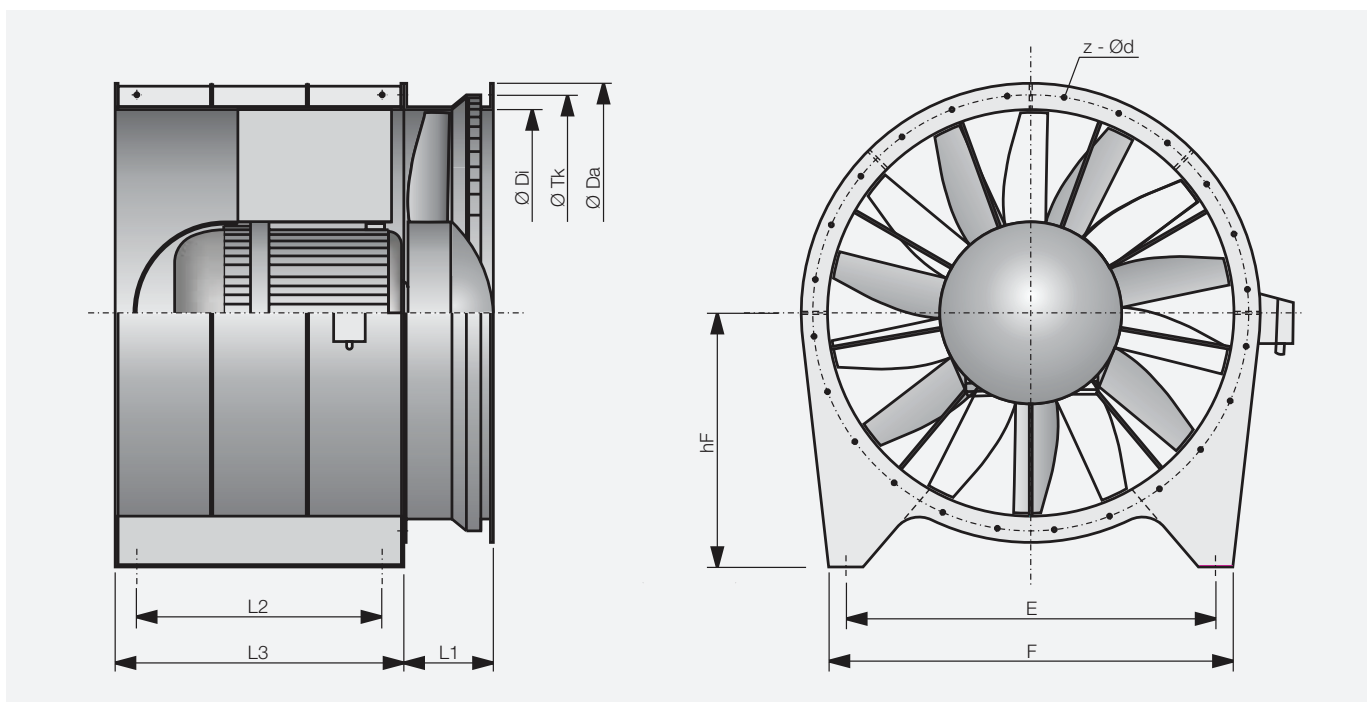

Model size	Da [mm]	Di [mm]	hF [mm]	z x d [mm]	Tk [mm]	E [mm]	F [mm]	L1 [mm]	L2 [mm]	L3 [mm]
1800	2010	1805	1120	24x18	1920	1660	1800	400	1200	1400
2000	2210	2005	1165	32x18	2120	1820	2000	445	1300	1500
2200	2440	2205	1265	32x18	2340	2020	2200	490	1400	1650
2400	2630	2405	1370	32x18	2530	2220	2400	550	1500	1800
2500	2740	2505	1420	36x24	2640	2320	2500	555	1530	1820
2600	2840	2605	1470	36x24	2740	2380	2600	590	1580	1850
2800	3150	2805	1570	36x24	3000	2500	2800	1300	1680	1900

ED
Bellmouth inlet

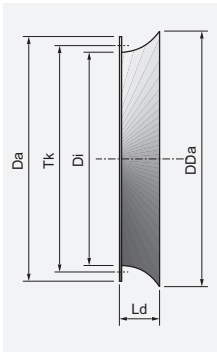

GL-AXV
Matching flange

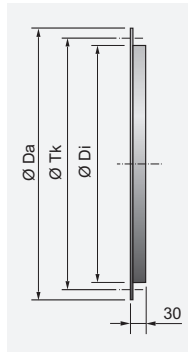

EV-AXV
Flexible connector

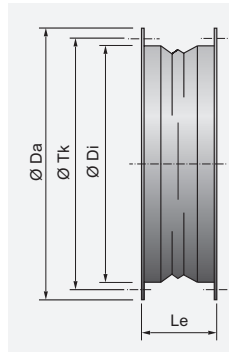

LRK
Air-operated damper

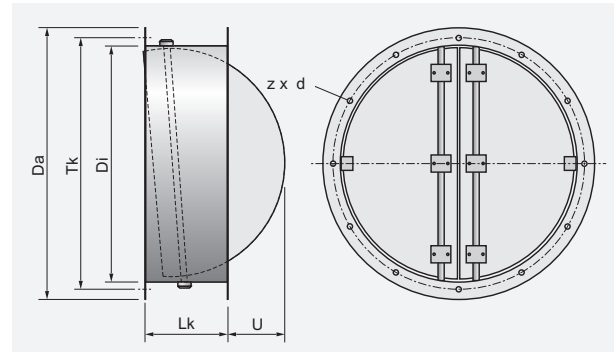

Model size	Da [mm]	Di [mm]	Tk [mm]	z x d [mm]	DDa [mm]	Ld [mm]	Lk [mm]	Le [mm]	U [mm]
500	584	504	551	12 x 12	617	165	250	130	45
560	664	565	629	16 x 14	667	165	250	130	80
630	734	634	698	16 x 14	757	165	250	130	120
710	814	711	775	16 x 14	816	170	350	130	60
800	904	797	861	12* x 14	915	250	350	130	110
900	1004	894	958	12* x 14	1015	250	350	130	170
1000	1105	1003	1067	12* x 14	1115	250	350	130	225
1120	1245	1125	1200	16* x 18	1243	250	350	130	255
1250	1370	1250	1337	16* x 18	1364	250	400	170	375
1400	1525	1405	1475	16* x 18	1523	250	400	170	450
1600	1725	1605	1675	20* x 18	1723	250	400	170	550

Sound power levels

This term refers to the power which a source radiates as sound. Sound power levels are expressed in decibels with a reference level of 1 picowatt. The sound power level of a source remains the same regardless of its environment and the distance to the listener.

If the sound power frequency spectrum is needed, for as follows: example, the design of sound attenuators, the A-weighted rated sound power levels at particular octave band frequency L_{WA} can be calculated by subtracting the relative sound L_{wrel} :

$$L_{WA} = L_{wi} + L_{wrel}$$

Sound pressure level

These are pressure fluctuations generated by a source expressed in decibels with a reference level of 20 µPa. The sound pressure level varies with the distance of a sound source to the listener and its environment.

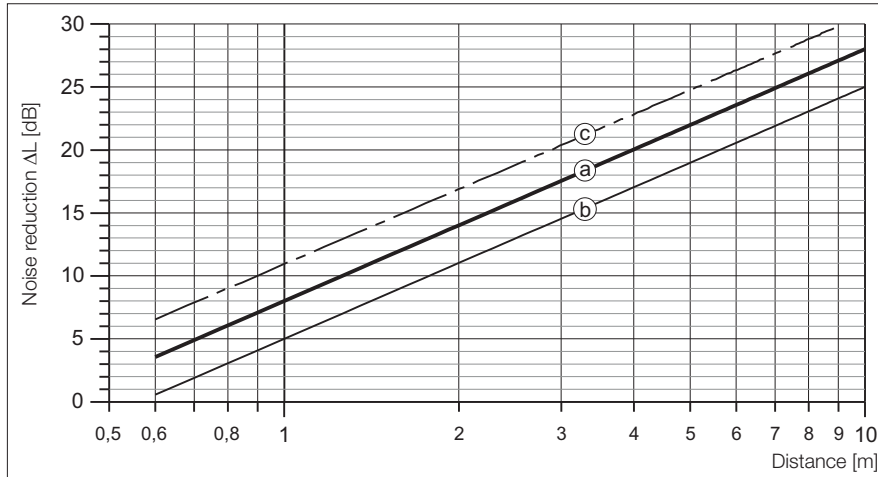

Sound level reduction half sphere

- a: without reflexion
- b: with reflexion
- c: full sphere without reflexion

Frequencies

Sound is split into different frequencies. Frequencies of human hearing range from about 20 cycles per second (Hz) to 20,000 cycles per second (Hz). For practical purposes, WOLTER publishes noise data in eight octave bands with the centre frequencies of (63,) 125, 250, 500, 1000, 2000, 4000 and 8000 Hz.

Each fan has its own specific correction factor which is to be deducted from sound power according to the octave band.

A-weighted sound pressure level in dB (A)

The human ear is more sensitive to sound in some frequencies than in others. The A-weighting is an attempt to reflect this natural perception of sound. The A-weighting is a set of figures which are applied to the sound pressure levels. The levels in each of the octave bands are added logarithmically to give a single figure. The A-weighting over the octave band is as follows:

Table 1)

Frequency [Hz]	63	125	250	500	1000	2000	4000	8000
A-weighting [dB]	-26,2	-16,1	-8,6	-3,2	0	+1,2	+1,0	-1,1

Table 2)

Addition of sound levels

Difference between two sound levels [dB]	Add to the higher level [dB]
0 - 1	3
2 - 3	2
4 - 9	1
≥10	0

$$L_{\Sigma} = 10 \cdot \lg(10^{0,1 \cdot L_1} + 10^{0,1 \cdot L_2} + \dots + 10^{0,1 \cdot L_n})$$

where:

L_1 = sound level of a source 1
 L_{Σ} = resulting summation sound level

Summation of several congeneric sound levels

$$L_{\Sigma} = L_1 + 10 \cdot \lg(z)$$

where:

z = number of sources
 L_1 = sound level of a single source
 L_{Σ} = resulting summation sound level

Relative Sound Power Frequency Spectrum (L_{wrel}) [dB]

Fan Model	Poles	63	125	250	500	1000	2000	4000	8000
Size	[-]	[Hz]	[Hz]	[Hz]	[Hz]	[Hz]	[Hz]	[Hz]	[Hz]
500	2	-11	-8	-10	-7	-8	-12	-16	-21
	4	-8	-10	-6	-8	-11	-16	-21	-26
	6	-8	-8	-5	-10	-13	-18	-23	-28
560	2	-11	-8	-10	-7	-8	-12	-16	-21
	4	-8	-10	-6	-8	-11	-16	-21	-26
	6	-8	-8	-5	-10	-13	-18	-23	-28
630	2	-11	-8	-10	-7	-8	-12	-16	-21
	4	-8	-10	-6	-8	-11	-16	-21	-26
	6	-8	-8	-5	-10	-13	-18	-23	-28
710	2	-11	-8	-10	-7	-8	-12	-16	-21
	4	-8	-10	-6	-8	-11	-16	-21	-26
	6	-8	-8	-5	-10	-13	-18	-23	-28
800	4	-8	-10	-6	-8	-11	-16	-21	-26
	6	-8	-8	-5	-10	-13	-18	-23	-28
	8	-9	-5	-6	-10	-15	-19	-24	-30
900	4	-7	-10	-6	-8	-11	-16	-21	-26
	6	-8	-8	-5	-10	-13	-18	-23	-28
	8	-9	-5	-6	-10	-15	-19	-24	-30
1000	4	-10	-5	-6	-8	-14	-18	-24	-29
	6	-7	-6	-5	-10	-15	-20	-26	-31
	8	-7	-5	-6	-11	-15	-21	-27	-32
1120	4	-10	-5	-6	-8	-14	-18	-24	-29
	6	-7	-6	-5	-11	-15	-20	-26	-31
	8	-6	-5	-6	-11	-16	-22	-27	-32
1250	4	-9	-5	-6	-8	-14	-18	-24	-30
	6	-6	-6	-6	-11	-15	-21	-26	-31
	8	-6	-5	-6	-12	-16	-22	-27	-32
1400	4	-9	-5	-4	-5	-7	-9	-12	-15
	6	-11	-6	-5	-6	-9	-13	-16	-20
	8	-11	-6	-6	-9	-13	-18	-22	-26
1600	4	-9	-5	-4	-5	-7	-9	-12	-15
	6	-11	-6	-6	-6	-9	-13	-16	-20
	8	-10	-6	-7	-9	-13	-18	-22	-26

• Sound power frequency spectrum calculated with this L_{wrel} are not licensed by AMCA International.

Relative Sound Power Frequency Spectrum (L_{wrel}) [dB]

Fan Model	Poles	63	125	250	500	1000	2000	4000	8000
Size	[-]	[Hz]	[Hz]	[Hz]	[Hz]	[Hz]	[Hz]	[Hz]	[Hz]
1800	6	-7	-4	-4	-6	-8	-11	-13	-17
	8	-9	-5	-5	-7	-10	-14	-18	-22
	10	-8	-6	-7	-10	-15	-19	-23	-27
2000	6	-7	-4	-4	-6	-8	-11	-13	-17
	8	-8	-5	-5	-7	-10	-14	-18	-22
	10	-8	-6	-7	-10	-15	-19	-23	-27
2200	8	-6	-3	-4	-6	-9	-11	-14	-18
	10	-7	-5	-5	-8	-12	-15	-19	-23
	12	-7	-6	-7	-11	-16	-20	-24	-28
2400	8	-5	-3	-4	-6	-9	-12	-15	-18
	10	-7	-5	-5	-8	-12	-15	-19	-23
	12	-6	-6	-8	-11	-16	-20	-24	-28
2500	8	-5	-3	-4	-6	-9	-12	-15	-18
	10	-7	-5	-5	-8	-12	-15	-19	-23
	12	-6	-6	-8	-11	-16	-20	-24	-28
2600	8	-5	-3	-4	-7	-9	-12	-15	-18
	10	-7	-5	-5	-8	-12	-15	-19	-23
	12	-6	-6	-8	-11	-16	-20	-24	-28
2800	8	-5	-3	-4	-7	-9	-12	-15	-18
	10	-7	-5	-6	-8	-12	-15	-19	-23
	12	-6	-6	-8	-11	-16	-20	-24	-28

• Sound power frequency spectrum calculated with this L_{wrel} are not licensed by AMCA International.

Tubular Sound Attenuator for AXV-F

SA, SPA



SPA 1000 -1D

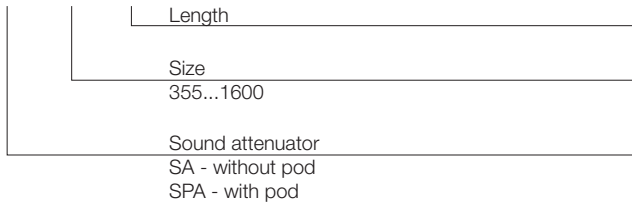

Attenuators made of galvanised sheet steel. Connecting flanges correspond to those of the axial fan series.

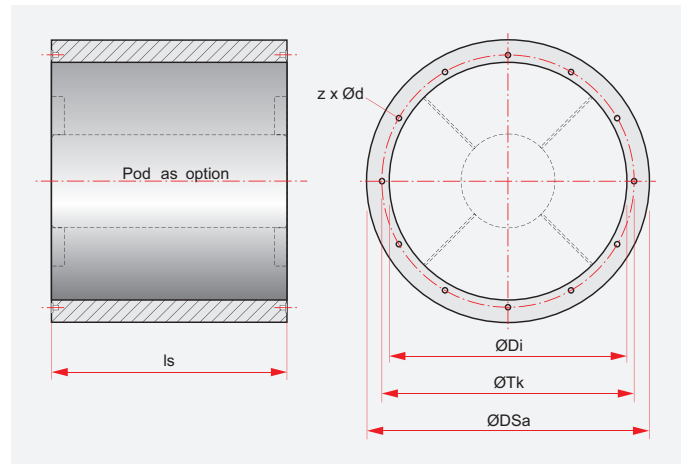

Size	DSa	Tk	Di	ls						Length	Type	Pitch angle	Octave band mid-frequency [Hz]												
				x 1D	x 2D	SA-1D	SPA-1D	SA-2D	SPA-2D				63	125	250	500	1k	2k	4k	8k					
	[mm]	[mm]	[mm]	[mm]	[mm]	[kg]	[kg]	[kg]	[kg]			setting													
355	459	405	359	355	710	12	18	16	23	1D	SA-1D	all	2	4	6	10	14	10	7	8					
400	601	448	401	400	800	14	23	19	29		SPA-1D	low	4	6	8	13	20	21	18	16					
450	650	497	450	450	900	18	29	23	36			med	4	6	8	12	18	19	18	14					
												high	4	6	8	11	13	16	16	11					
											2D	SA-2D	low	4	7	12	18	22	17	12	13				
													med	4	7	11	17	21	17	13	12				
													high	4	7	10	15	19	16	13	10				
												SPA-2D	low	7	10	15	24	32	35	30	28				
													med	7	10	15	21	26	26	24	22				
													high	7	10	15	16	15	17	13	13				
500	704	551	504	500	1000	22	36	28	43		1D	SA-1D	all	3	4	8	14	14	9	8	7				
560	765	629	565	560	1120	25	41	31	50			SPA-1D	low	4	6	9	17	26	21	18	12				
630	834	698	634	630	1260	29	47	37	59			med	4	6	9	17	23	20	18	11					
710	911	775	711	710	1420	37	60	47	75			high	4	6	9	16	17	16	14	11					
800	997	861	797	800	1600	69	108	90	141	2D		SA-2D	low	6	8	14	23	24	15	13	10				
													med	6	8	13	22	22	14	13	9				
													high	6	8	12	20	18	13	11	9				
												SPA-2D	low	8	11	16	30	39	35	32	22				
													med	8	11	16	27	32	32	29	19				
													high	8	11	16	24	23	23	24	17				
900	1094	958	894	900	1800	86	135	112	176	1D		SA-1D	all	3	4	9	14	12	8	7	7				
1000	1203	1067	1003	1000	2000	125	190	156	234			SPA-1D	low	4	6	11	22	21	16	14	11				
1120	1325	1200	1125	1120	2240	132	210	169	260			med.	4	6	11	20	19	15	13	11					
1250	1450	1337	1250	1250	2500	146	234	185	294			high	4	6	11	17	17	14	12	11					
											2D	SA-2D	low	6	8	14	22	20	13	12	10				
													med.	6	8	13	21	18	12	11	10				
													high	6	8	12	19	15	11	10	9				
												SPA-2D	low	8	11	19	30	32	30	24	17				
													med.	8	11	19	26	27	26	22	17				
													high	8	11	19	21	20	22	20	16				
1400	1605	1475	1405	1400	2800	197	316	250	397		1D	SA-1D	all	4	5	10	14	11	7	6	6				
1600	1805	1675	1605	1600	3200	275	540	348	682			SPA-1D	low	5	7	12	21	20	14	12	9				
												med.	5	7	12	19	18	13	11	9					
												high	5	7	12	15	16	12	10	8					
										2D		SA-2D	low	8	9	15	20	19	12	11	9				
													med.	8	9	14	20	17	11	10	9				
													high	8	9	13	19	14	10	9	9				
												SPA-2D	low	10	14	22	28	31	29	18	15				
													med.	10	14	22	25	27	25	16	15				
													high	10	14	22	21	21	21	15	14				

• Low, Medium and High Pitch Angle setting correspond to 10°, 22° and 35° pitch angle approximately; for other pitch angles use interpolation.

• Sizes 1800 - 2800 TBA.



Pressure Loss SPA - 1D

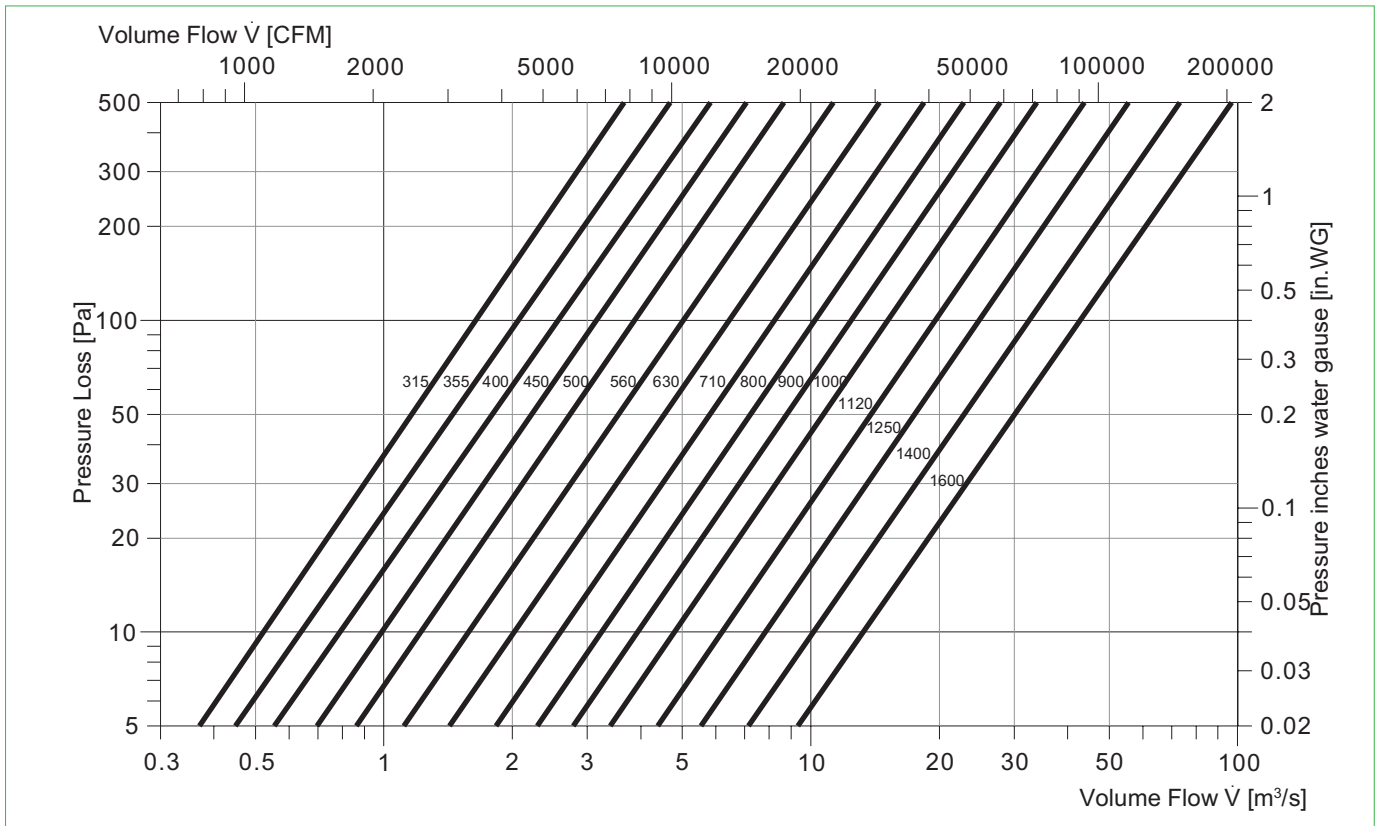

Pressure Loss SPA - 2D

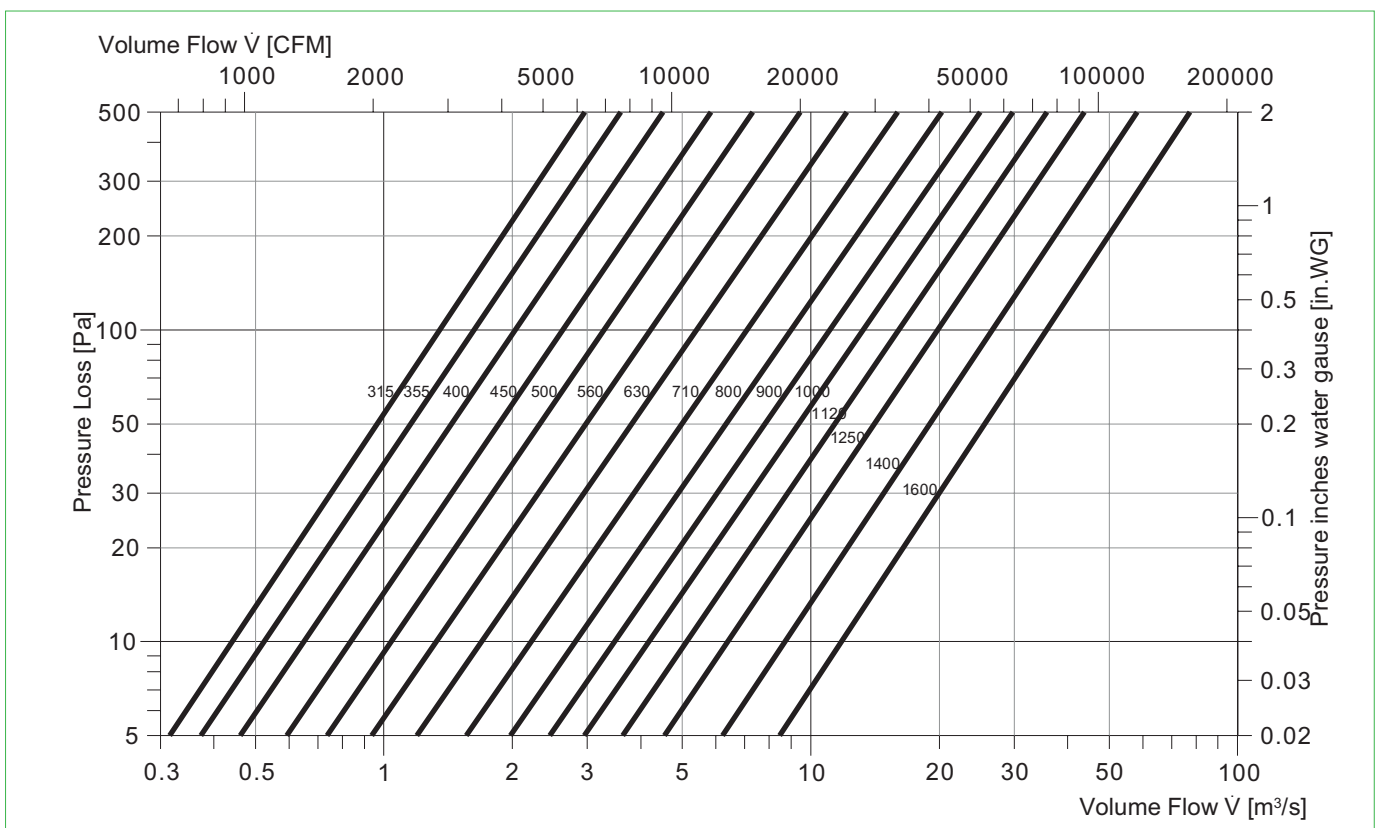

• Performance of sound attenuator are not licensed by AMCA International.

Wolter Sales Network

Inland

Ing. Günther Rößler
D-07619 Schkölen
Tel. (+49) 03 66 94 / 22 359
Fax (+49) 03 66 94 / 22 357
guenther.roessler@wolterfans.de

Mattias Industrievertretungen
D-16259 Bad Freienwalde
Tel. (+49)03344/301994
Fax (+49)03344/301996
thomas.mattias@wolterfans.de

Industrieservice Drexler
D-49080 Osnabrück
Tel. (+49) 0 541 / 20 04 88 3
Fax (+49) 0 541 / 20 04 88 4
wolfgang.drexler@wolterfans.de

Burkhardt Projekt GmbH
D-67583 Guntersblum
Tel. (+49) 0 62 49 / 82 01
Fax (+49) 0 62 49 / 88 58
info@bp-wolter.de

Friedrich Glock
D-97980 Bad Mergentheim
Tel. (+49) 0 79 31 / 37 44
Fax (+49) 0 79 31 / 28 58
friedrich.glock@wolterfans.de

Europe

Danmark:

Aircon Teknik A/S
DK-8200 Aarhus N
Tel. +45 (0) 86 / 34 51 11
Fax +45 (0) 86 / 34 58 10
post@airconteknik.dk

The Netherlands:

AirFan B. V.
NL-7442 CX Nijverdal
Tel. (+31)054/8366366
Fax (+31)054/8365320
ventilatie@airfan.nl

Poland:

Wentoprodukt
44-100 Gliwice
Tel. (+48)32 33 13 424
Fax (+48)32 72 97 653 75
biuro@wentoprodukt.pl

Russia:

Daichi Co. Ltd
RU-123022 Moscow
Tel. +7 (0) 495 / 73 73 733
Fax +7 (0) 495 / 73 73 732
info@daichi.ru

Switzerland:

Anson AG Zürich
CH-8055 Zürich
Tel. (+41) 0 44 / 46 11 111
Fax (+41) 0 44 / 46 13 111
info@anson.ch

Ventra Technik AG
CH-8599 Salmsach
Tel. (+41) 0 71 / 46 11 447
Fax (+41) 0 71 / 46 11 448
ventra@bluewin.ch

Turkey:

Air Trade Centre Ltd Sti Türkiye,
TR-34418 Seyrantepe / Istanbul
Tel. (+90) 02 12 / 28 34 510
Fax (+90) 02 12 / 27 83 964
atc.turkey@airtradecentre.com

United Kingdom:

Wolter (UK) Ltd.
GB-Leicestershire LE65 1AL
Tel. (+44) 01530 / 412 473
info@wolteruk.com

Middle East and North Africa

Israel:

Pach Taas (Ashkelon) Ltd.
IL-78100 Ashkelon
Tel. (+972) 0 8 / 67 19 770
Fax (+972) 0 8 / 67 19 771
info@pachtaas.com

UAE, Qatar, Lebanon, Jordan, Saudi Arabia:

Energy International Co.
UAE-Sharjah, P.O. Box 3562
Tel. (+971) 06 / 53 43 477
Fax (+971) 06 / 53 43 756
fsalibi@energysa.ae

Energy International Co.
P.O. Box 45217 Abu Dhabi, UAE
Tel. (+971) 2 67 11 10 8
Fax (+971) 2 67 69 669
amohsen@energyintl.ae

Energy International Co.(Dubai-Sharjah)
P.O. Box 3562 Sharjah, UAE
Tel. (+971) 65 34 34 77
Fax (+971) 65 34 37 56
fsalibi@energysa.ae

Energy International Corporation
Malaz Area, Siteen Highway Beside BANK
ALBILAD Riyadh, Saudi Arabia
Tel. (+966) 14 15 39 59
msheet@energyintl.com

Energy International Corporation
P.O. Box 37364 Doha, Qatar
Tel. (+974) 45 80 765
Fax (+974) 45 81 126
aassi@energyintl.com

Energy International
234 Balbesi Blg 2nd floor Al-Madinah,
Al Munawarah St Amman, Jordan
Tel. (+962) 65 67 19 15
Fax (+962) 65 67 19 16
eabuzahra@energyintl.com

Energy International & Engineering
Mar Roukoz Center-Block B - First Floor,
Hazmieh, Lebanon
Tel. (+961) 54 50 61 0
Fax (+961) 54 51 16 9
bsaab@energyintl.com

Asia

China Mainland:

Dongguan Wolter Chemco Ventilation Ltd.
Chemco Building, Miao Bian Wang Ind.
Shipai, Dongguan City, Guangdong
Tel. (+86) 0 769 / 8655 7298
Fax (+86) 0 769 / 8655 7278
info@wolterfans.com

Taizhou Wolter Ventilation Co. Ltd.
Hengjie, Luqiao District
Taizhou City, Zhejiang
Tel. (+86) 0 576 / 26 22 666 (26 52 888)
Fax (+86) 0 576 / 26 56 830

Hongkong:

Wolter Asia Ltd.
Hong Kong
Tel. (+852) 0 2456 0198
Fax (+852) 0 2456 0290
info@wolter.com.hk

India:

Wolter Ventilators India Pvt. Ltd.
867 D, Block-A, Sushant Lok, Phase-I,
Gurgaon - 122009 (Haryana)
Tel. +91 124 2577797, 4261001-3
sales@wolterindia.in

Indonesia:

PT. Agung Kipas Kastara.
ID-14440 Jakarta Indonesia
Tel. +62 (0) 21 / 6667 6925, 6667 6926
Fax +62 (0) 21 / 6667 6927
indowolter@cbn.net.id

Korea:

Kaceco-Wolter
14-1, Dang-dong, Gunpo-shi, Gyeonggi-do
Tel. +82 (0) 31 / 4773 104
Fax +82 (0) 31 / 4773 132
wolter@kaceco.com / info@kaceco.com

Malaysia:

Vibrantech (M) Sdn Bhd.
47200 Petaling Jaya Selangor, Malaysia
Tel. +603 (0) 7847 3500
Fax +603 (0) 7847 3380
sales@vibrantech-sb.com

Singapore:

Wolter Pte. Ltd.
SG-569738 Singapore
Tel. (+65) 0 63 / 52 95 48
Fax (+65) 0 63 / 52 95 47
info@wolterfans.com.sg

Sri Lanka:

Sirocco Air Technologies (Pvt) Ltd.
28/12, Gemunu Mawatha, Kotuwegoda,
Rajagiriya, Sri Lanka
Tel. +94 11 7 392 010
Fax +94 11 7 392 015
suren@sairt.com

Taiwan:

Waxlink International Co., Ltd.
8F-2 No.218 Roosevelt Rd., Sec.6,
Taipei, Taiwan
Tel. (+886) 02 / 8932 1196
Fax (+886) 02 / 8932 1197
waxlink@mail.waxlinktw.com

Thailand:

Wolter Ventilation Co., Ltd.
Thamai Kratumban Samutsakorn 74110
Thailand
Tel. +66 (0) 3486 6555
Fax +66 (0) 3486 6599
natiphan@wolterfan.com

Australia

The Sydney Fan Company.

NSW 2147, Sydney, Australia
Tel. +61 (0) 2 / 9624 4000
Fax +61 (0) 2 / 9624 4100
sales@thesydneyfancompany.com

Wolter GmbH

Maschinen-und Apparatebau KG

Am Wasen 11
D-76316 Malsch / Germany
Tel. +49 (0) 7204/9201-0
Fax +49 (0) 7204/9201-11
www.wolter.eu
info@wolter.eu





Reference: **A09-F**, V2017/September, Printed in September, 2017