

## Vane Axial Flow Fans

- Direct Driven
- Belt Driven



## A09-E

Dongguan Wolter Chemco Ventilation Ltd. certifies that the series AXV-E shown herein are licensed to bear the AMCA Seal. The ratings shown are based on tests and procedures performed in accordance with AMCA Publication 211 and AMCA Publication 311 and comply with the requirements of the AMCA Certified Ratings Program.



# Table of Content



Contents	Page 1
Fan Type Code	Page 2
Design Features	Page 2
Fan Installation, Forms of Running	Page 3
Selection Selection Sample	Page 4
AMCA FEG Rating	Page 5
Fan Performance Curves - 50Hz	Page 6~19
AMCA FEG Rating	Page 20
Fan Performance Curves - 60Hz	Page 21~34
Dimensions	Page 35~36
Accessories	Page 37
Sound Information	Page 38~39
Tubular sound attenuator for AXV-E	Page 40~41

Subject to change without prior notice.

### Fan type code

AXV-E 800 / 50°

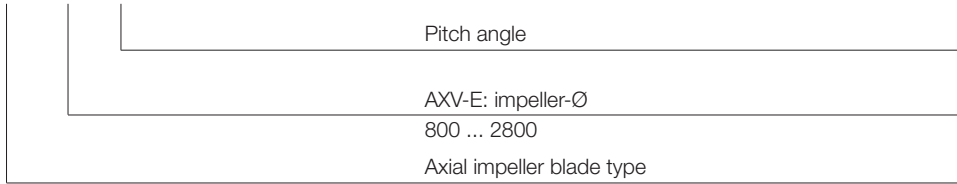

### Design features

#### Types and duty range

**Wolter** vane axial fans can be used for various applications in ventilation and process air technology. Standard diameters range from 800 to 2,800 mm, with airflow rates of up to 300 m<sup>3</sup>/s at static pressure increases of up to 2,500 Pa. The high efficiencies and high pressures are achieved by the use of the aerodynamically designed outlet guide vanes.

#### Application

The AXV-E range of vane axial fans is designed and tested to operate at standard temperatures as well as at elevated temperatures of 300°C for 60 (F300) and 120 minutes and 400°C for at least 120 minutes (F400), according to DIN EN ISO 12101, part 3. The following fan curves are valid for standard temperatures and 300°/60(120) minutes operation. To select a fan for 400°C/120 minutes operation, please contact our technical support.

Well suited for industrial applications, ventilation and for conveying clean and dusty air where medium pressures are required with a high airflow volume and fan efficiency.

#### Casing

Fan casings are made of steel, with flanges rolled on both sides. The pitch circles of holes are in accordance with DIN 24 154, R2. The fan casings are hot dipped galvanised as standard. Optional: Optimal corrosion protection by powder-coating.

If motors require additional lubrication, tubes and grease-nipples are fitted to the outside of the fan casing. An inspection hole, closed by a rubber plug, allows controlling the direction of rotation.

#### Impellers

Hubs and impeller blades are made of highly corrosion resistant pressure-cast aluminium alloy. The aero dynamical profile of the impeller blades guarantees a high level of efficiency and low noise. The blade angle is adjustable during standstill. The variable number of blades expands the performance range. Dynamically balanced according to DIN ISO 1940-1, balancing quality G6.3.

### Motors

**Wolter** uses closed squirrel cage motors according to IEC 34, if required also in accordance with EPACT. Standard motors are class F with IP 55 protection class. Multi speed versions with 2 or 3 speeds (Dahlander circuit or separate windings) are also available, as well as explosion-proof versions or specific industrial executions such as marine-type fans. The motor bearings have a L 10 life.

### Fan performance curves

The performance curves for these fan types have been established in installation type - D (according to AMCA 210, ducted inlet and ducted outlet) and represent the total pressure increase  $\Delta p$ , as a function of the volume flow. The dynamic pressure  $p_{d2}$  refers to the outlet area of the fan.

### Sound levels

The ascertaining of sound level follows the Reverberant Room Method according to AMCA 300. The A-weighted inlet sound power levels  $L_{wA}$  is shown on the performance curves.

### Belt driven design

Belt driven fan with single / dual motors can be mounted in various positions to suit the actual site condition. Belt driven fans are used for applications to extract more heavily polluted air i.e. presence of corrosive or hazardous fumes, or dirt-laden, moist air or hot air from professional kitchens. Various mounting positions are illustrated.

### Ordering designations

When ordering, please provide the following information:

- › Fan type
- › Fan code and type
- › Quantity required
- › Duty required at standard air and temperature (air volume in m<sup>3</sup>/h at static pressure in Pa).
- › Motor power rating in kW
- › Electrical supply
- › Ancillaries required

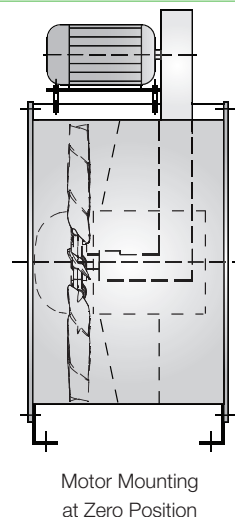
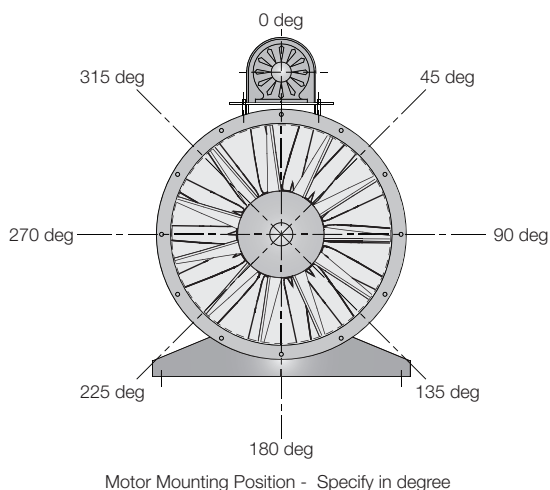

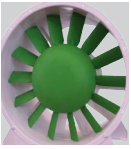

AXV-E

## Fan selection and installation

### Fan selection

Please select fans according to the nearest performance curve above the required duty point. The middle range of each fan curve is the area of highest efficiency. Do not select fans at the upper end of the fan curve, as this might cause the fan to work in stall. In order to avoid motor overloading, please select motors according to the peak power of the respective performance curve. Please refer to the selection example on the following page.

### Fan installation

When installing the fan, please consider the following instructions:

► Fans with free inlet and outlet should be installed with an unobstructed distance of at least 1,5 x fan diameter on suction and pressure sides. Fans should have a bellmouth on the inlet side in order to assure optimal incoming flow. A diffuser mounted on the pressure side will increase efficiency.

► When installing fans in a ducted system, adequate distance to other structural parts such as bends, filters and silencers should be provided for. A sharp bend radius of the duct near the suction or pressure side of the fan is to be avoided. Flexible connections are to be installed in a way that does not obstruct the outlet cross section of the fan (see following page).

### Forms of running

Wolter axial flow fans are available for all forms of running. The chart below shows all standard forms of running. Please indicate the required configuration when ordering. Arrows outside the fan casing indicates the correct direction of rotation and airflow.

Form S, SU and SO are not licensed by AMCA International.

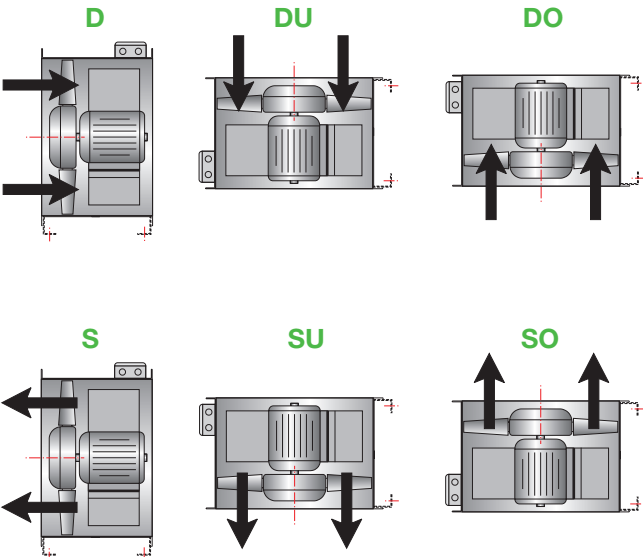
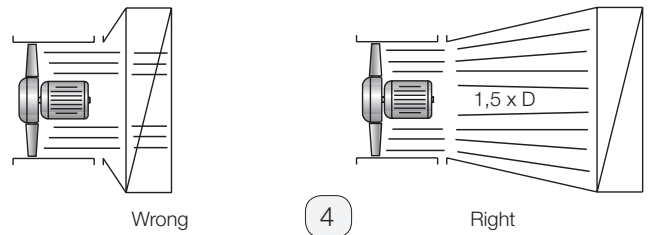
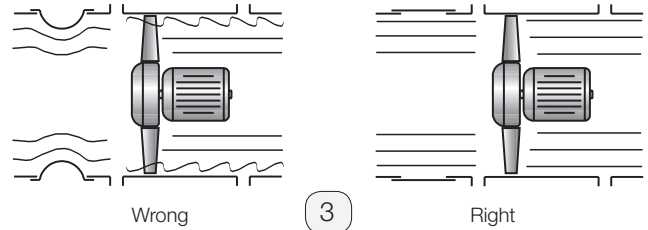
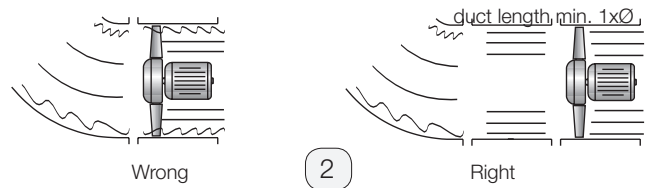
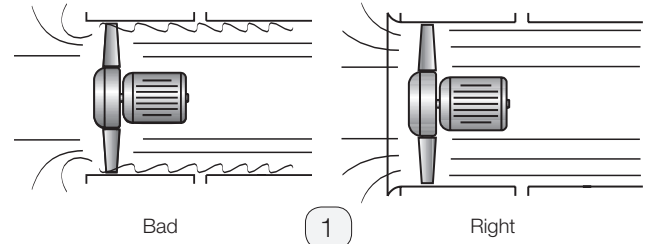

### Selection example

#### Required duty point

- Volume flow: 7 m<sup>3</sup>/s
- Static pressure: 900 Pa

In order to calculate the total pressure, please add velocity pressure to static pressure (120 Pa dynamic pressure + 900 Pa static pressure = 1020 Pa total pressure)

- Fan speed: 1.500 1/min (4-pole)

#### Using the fan curve

Having chosen a fan with adequate performance range for the required duty point, plot volume flow and pressure.

At the point of intersection, the following data can be read:

- Motor speed or number of poles 1.500 1/min - 4-pole
- Pitch angle: 50 degrees
- Absorbed power: 13,40 kW
- Sound Power Level: 109 dBA

### Calculation of motor power

There are two possibilities to calculate the motor power:

- Calculation of absorbed power by using the fan curve in duty point: 13,40 kW

Motor power: 15 kW

- Calculation according to peak absorbed power, see table below the fan curve: 14,36 kW

Motor power: 15 kW

The given peak absorbed power is the maximum shaft absorbed power over the whole pitch angle curve in.

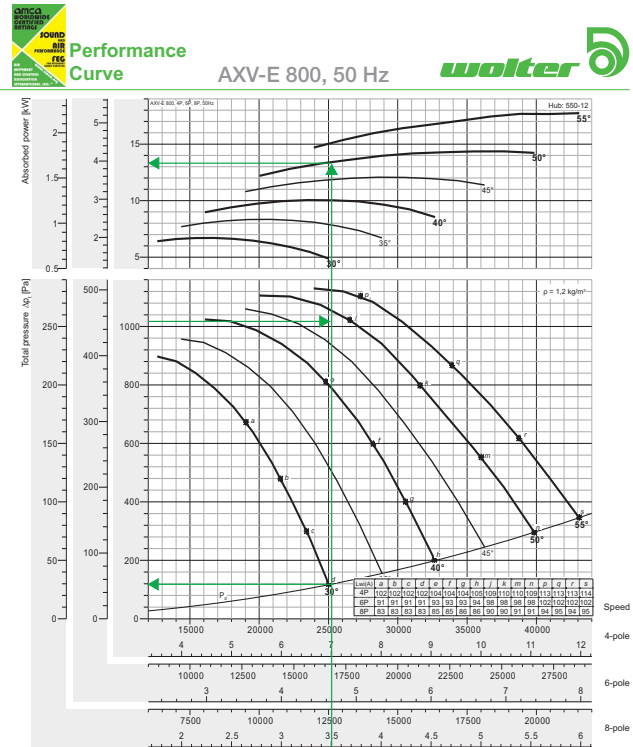

N Poles	Pitch angle [°]						
	25	30	35	40	45	50	55
4P motor	-	6,70	8,34	10,05	12,07	14,36	17,74
6P motor	-	7,5	11	-	15	-	18,5
8P motor	-	1,98	2,47	2,98	3,58	4,26	5,26
motor	-	2,2	3	-	4	5,5	-
8P motor	-	0,838	1,04	1,26	1,51	1,80	2,22
motor	-	1,1	-	1,5	2,2	-	3

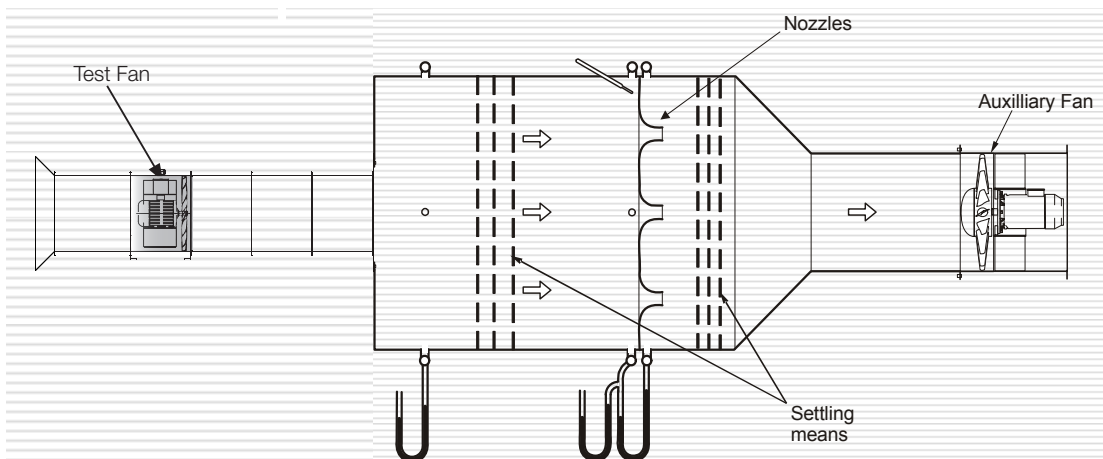

AMCA 210 Figure 12  
ISO 5801 Figure 73b



Certified FEGs are determined in accordance with AMCA 205-12 Energy Efficiency Classification for fans. In conjunction with AMCA 211-13 (Rev. 2015) Certified Ratings Program, Product Rating Manual for Fan Air Performance. This classification is based on fan peak (optimum) total efficiency for a given fan speed, fan size and application category. For the purpose of energy classification, the peak efficiency can be determined at a speed not higher than the maximum design speed of the fan.

The AMCA Certified Ratings Seal applies to the Fan Efficiency Grade (FEG) for AXV-E series Axial Fan model AXV-E 800 to AXV-E 2800 as shown in the table below.

Fan Model No.	Fan Speed (rpm)	Fan Outlet Area (m <sup>2</sup> )	Fan Efficiency Grades	Fan Model No.	Fan Speed (rpm)	Fan Outlet Area (m <sup>2</sup> )	Fan Efficiency Grade
AXV-E 800	1500/1000/750	0,4989	FEG60	AXV-E 1800	1000/750/600	2,5588	FEG67
AXV-E 900	1500/1000/750	0,6277	FEG63	AXV-E 2000	1000/750/600	3,1573	FEG67
AXV-E 1000	1500/1000/750	0,7901	FEG67	AXV-E 2200	750/600/500	3,8186	FEG67
AXV-E 1120	1500/1000/750	0,9940	FEG67	AXV-E 2400	750/600/500	4,5428	FEG67
AXV-E 1250	1500/1000/750	1,2272	FEG67	AXV-E 2500	750/600/500	4,9284	FEG67
AXV-E 1400	1000/750/600	1,5504	FEG67	AXV-E 2600	750/600/500	5,3297	FEG67
AXV-E 1600	1000/750/600	2,0232	FEG67	AXV-E 2800	750/600/500	6,1795	FEG67

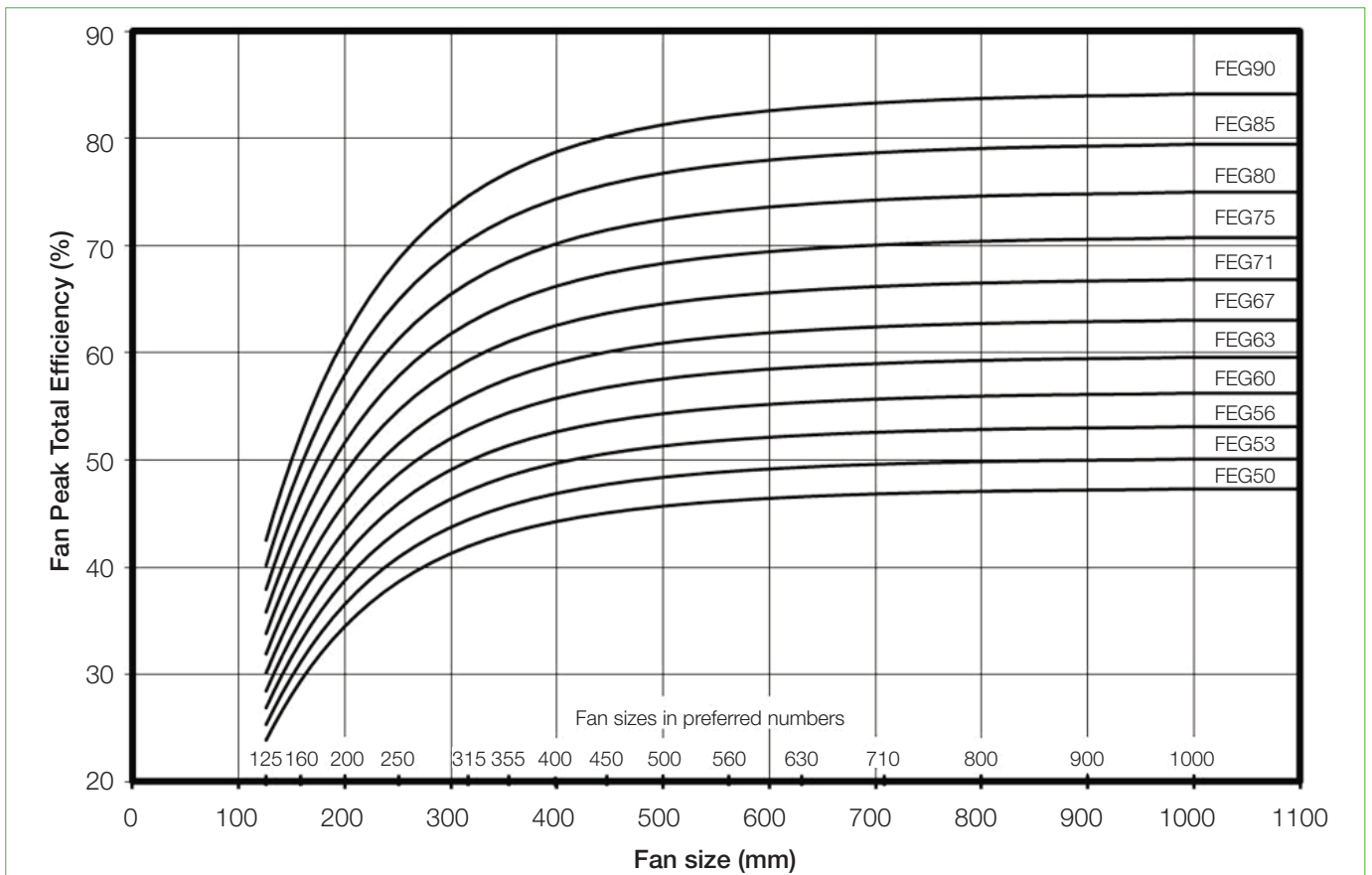



# Performance Curve

AXV-E 800, 50 Hz

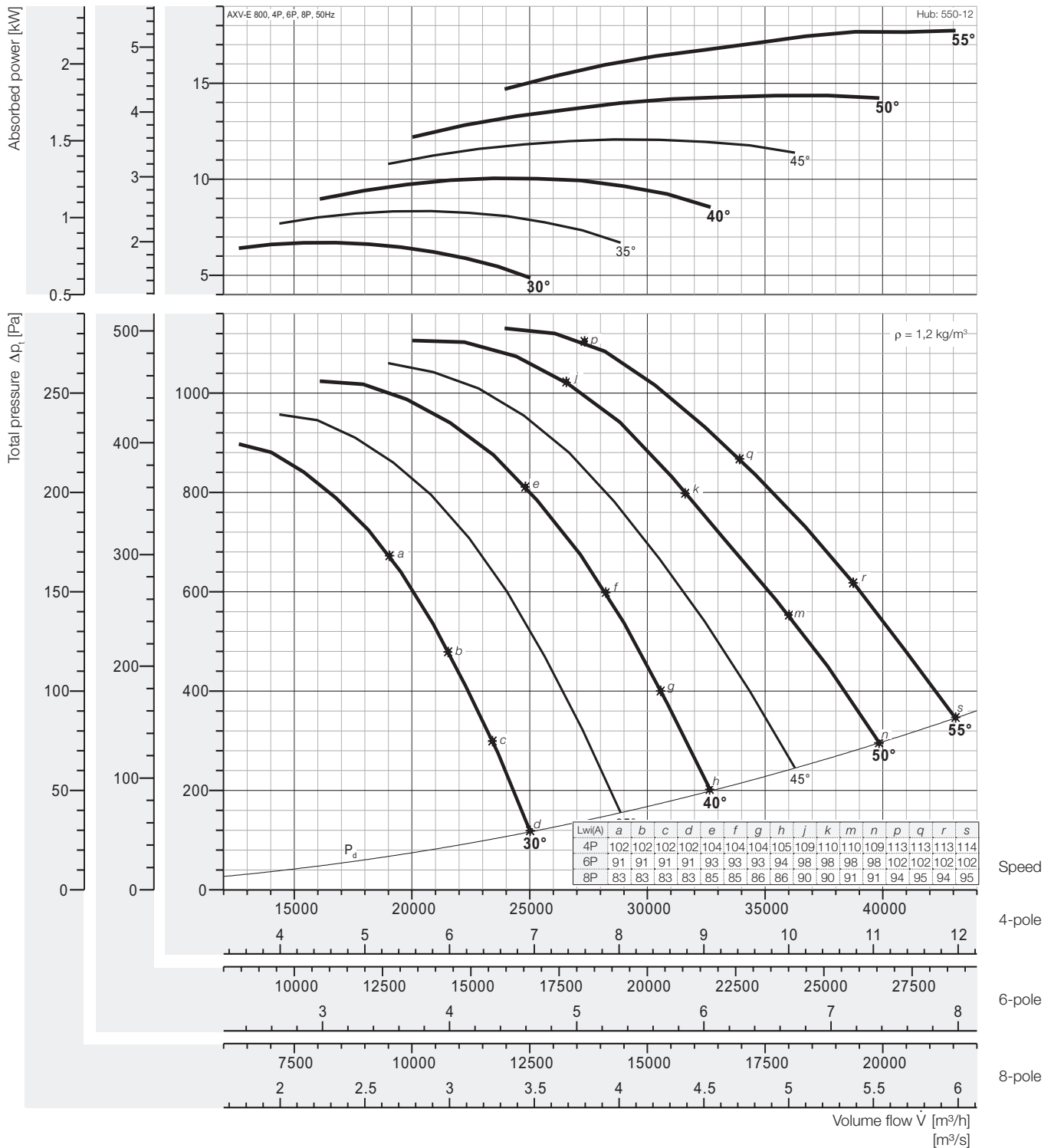

### Peak absorbed power [kW]

4-pole = 1500 rpm; 6-pole = 1000 rpm; 8-pole = 750 rpm;

N Poles	Pitch angle [°]						
	25	30	35	40	45	50	55
4P motor	-	6,70	8,34	10,05	12,07	14,36	17,74
6P motor	-	1,98	2,47	2,98	3,58	4,26	5,26
8P motor	-	0,838	1,04	1,26	1,51	1,80	2,22

Fan test laboratory AMCA 210/99 Fig.12, Test Chamber. Performance certified is for installation type D - Ducted inlet, Ducted outlet. Performance ratings do not include the effects of appurtenances (accessories-belt cover, pulley & belt). Power rating (kW) does not include transmission losses.

The A-weighted sound ratings shown have been calculated per AMCA International Standard 301. Values shown are for inlet Lw(A) sound power levels for installation Type D: ducted inlet, ducted outlet. Ratings include the effects of duct end correction.

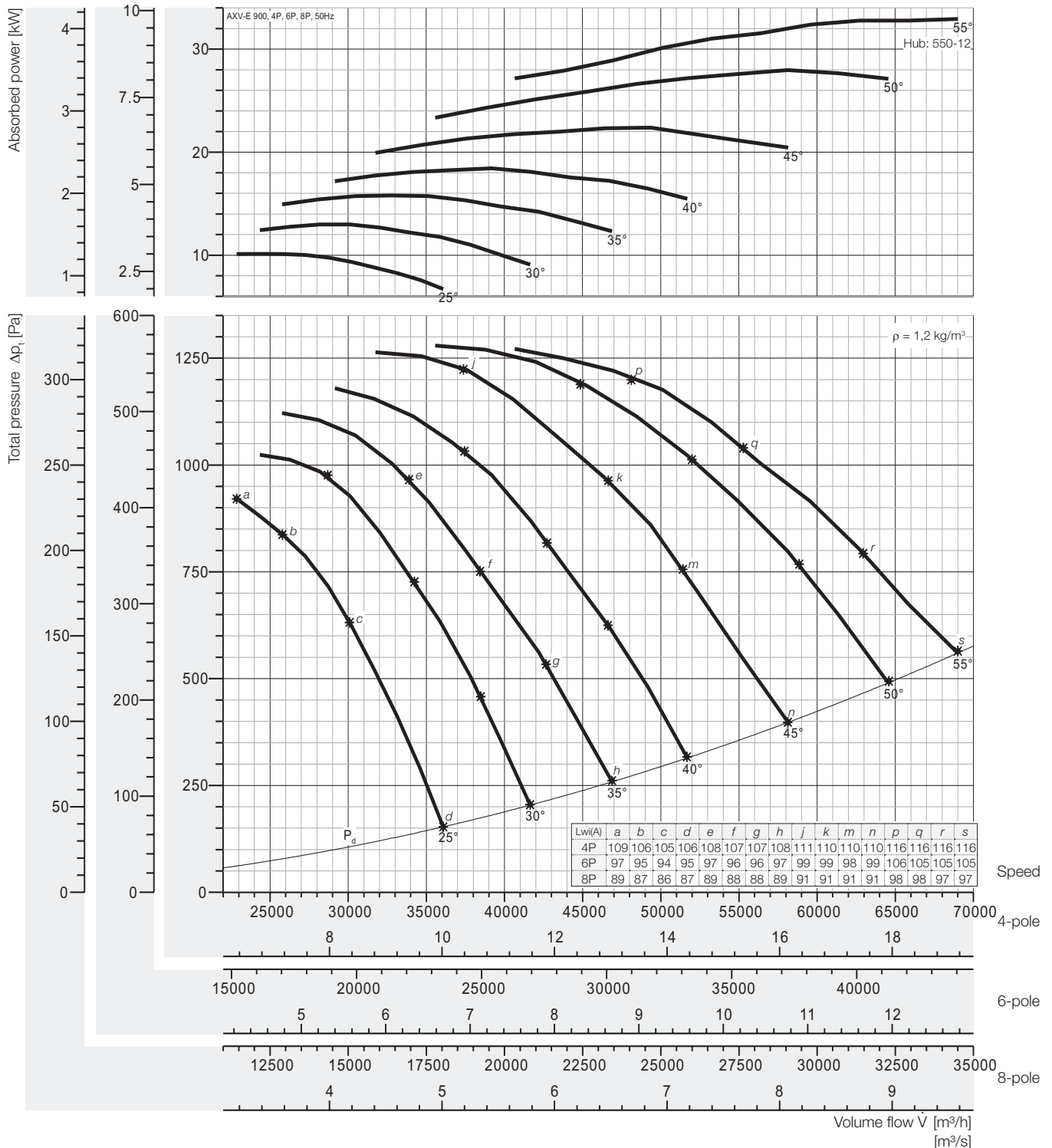

### Peak absorbed power [kW]

4-pole = 1500 rpm; 6-pole = 1000 rpm; 8-pole = 750 rpm;

N Poles	Pitch angle [°]						
	25	30	35	40	45	50	55
4P motor	10,13 11	12,98 15	15,79 18,5	18,44	22,38 30	27,96	32,93 37
6P motor	3,00 3	3,85 4	4,68 5,5	5,46	6,63 7,5	8,28 11	9,76 10,5
8P motor	1,27 1,5	1,62 2,2	1,97	2,31 3	2,80	3,49 4	4,12 5,5

Fan test laboratory AMCA 210/99 Fig.12, Test Chamber. Performance certified is for installation type D - Ducted inlet, Ducted outlet. Performance ratings do not include the effects of appurtenances (accessories-belt cover, pulley & belt). Power rating (kW) does not include transmission losses.

The A-weighted sound ratings shown have been calculated per AMCA International Standard 301. Values shown are for inlet Lw(A) sound power levels for installation Type D: ducted inlet, ducted outlet. Ratings include the effects of duct end correction.





# Performance Curve

## AXV-E 1000, 50 Hz

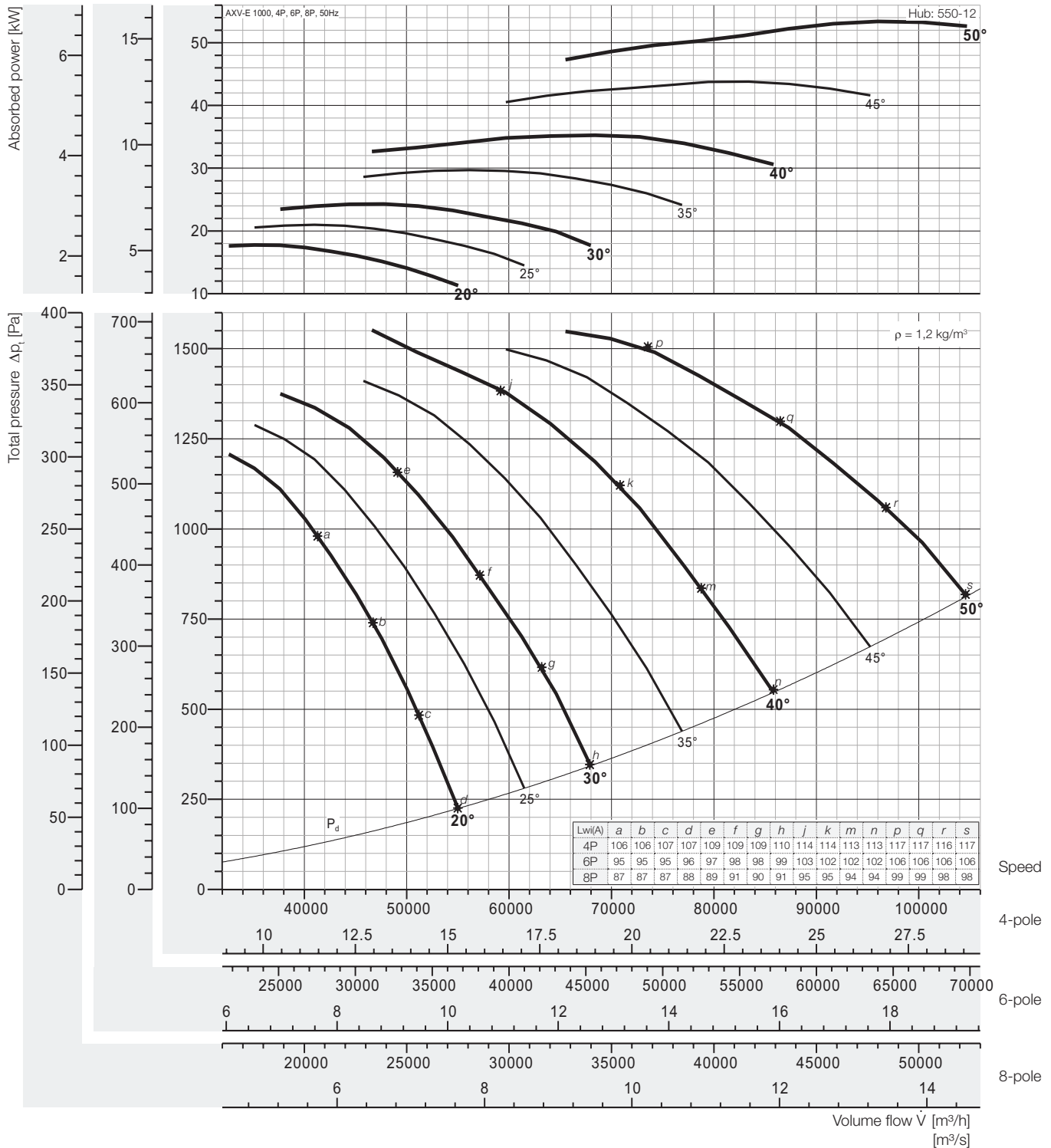

### Peak absorbed power [kW]

4-pole = 1500 rpm; 6-pole = 1000 rpm; 8-pole = 750 rpm;

N Poles	Pitch angle [°]						
	20	25	30	35	40	45	50
4P motor	17,77	20,99	24,27	29,70	35,26	43,79	53,41
6P motor	5,27	6,22	7,19	8,80	10,45	12,97	15,82
8P motor	2,22	2,62	3,03	3,71	4,41	5,47	6,68

Fan test laboratory AMCA 210/99 Fig.12, Test Chamber. Performance certified is for installation type D - Ducted inlet, Ducted outlet. Performance ratings do not include the effects of appurtenances (accessories-belt cover, pulley & belt). Power rating (kW) does not include transmission losses.

The A-weighted sound ratings shown have been calculated per AMCA International Standard 301. Values shown are for inlet Lw(A) sound power levels for installation Type D: ducted inlet, ducted outlet. Ratings include the effects of duct end correction.



# Performance Curve

## AXV-E 1120, 50 Hz

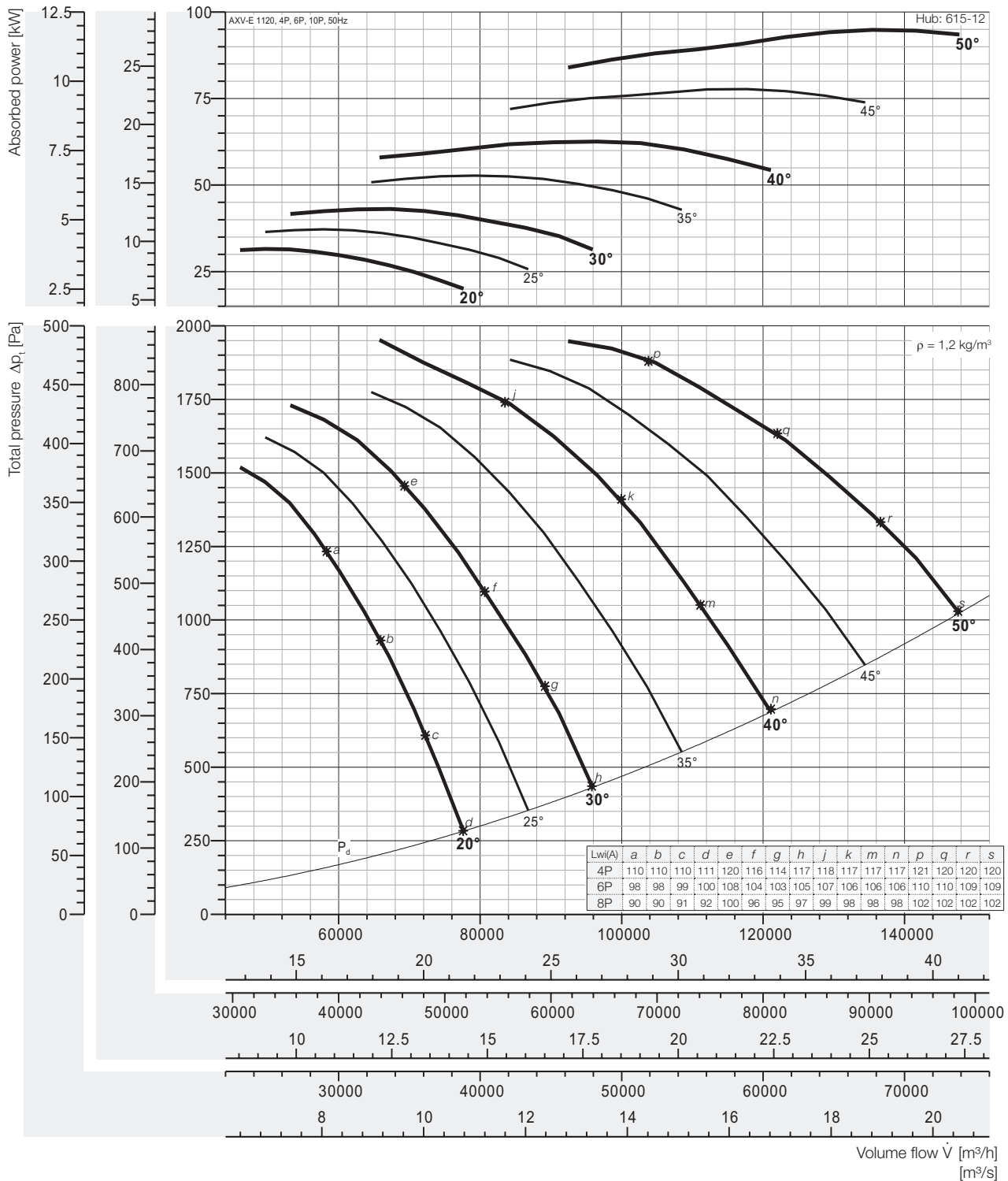

### Peak absorbed power [kW]

4-pole = 1500 rpm; 6-pole = 1000 rpm; 8-pole = 750 rpm;

N Poles	Pitch angle [°]						
	20	25	30	35	40	45	50
4P motor	31,55	37,26	43,09	52,73	62,59	77,74	94,81
	37	45		55	75	90	110
6P motor	9,35	11,04	12,77	15,62	18,55	23,03	28,09
	11	15		18,5	22	30	
8P motor	3,94	4,66	5,39	6,59	7,82	9,72	11,85
	4	5,5		7,5	11		15

Fan test laboratory AMCA 210/99 Fig.12, Test Chamber. Performance certified is for installation type D - Ducted inlet, Ducted outlet. Performance ratings do not include the effects of appurtenances (accessories-belt cover, pulley & belt). Power rating (kW) does not include transmission losses.

The A-weighted sound ratings shown have been calculated per AMCA International Standard 301. Values shown are for inlet Lw(A) sound power levels for installation Type D: ducted inlet, ducted outlet. Ratings include the effects of duct end correction.



# Performance Curve

## AXV-E 1250, 50 Hz

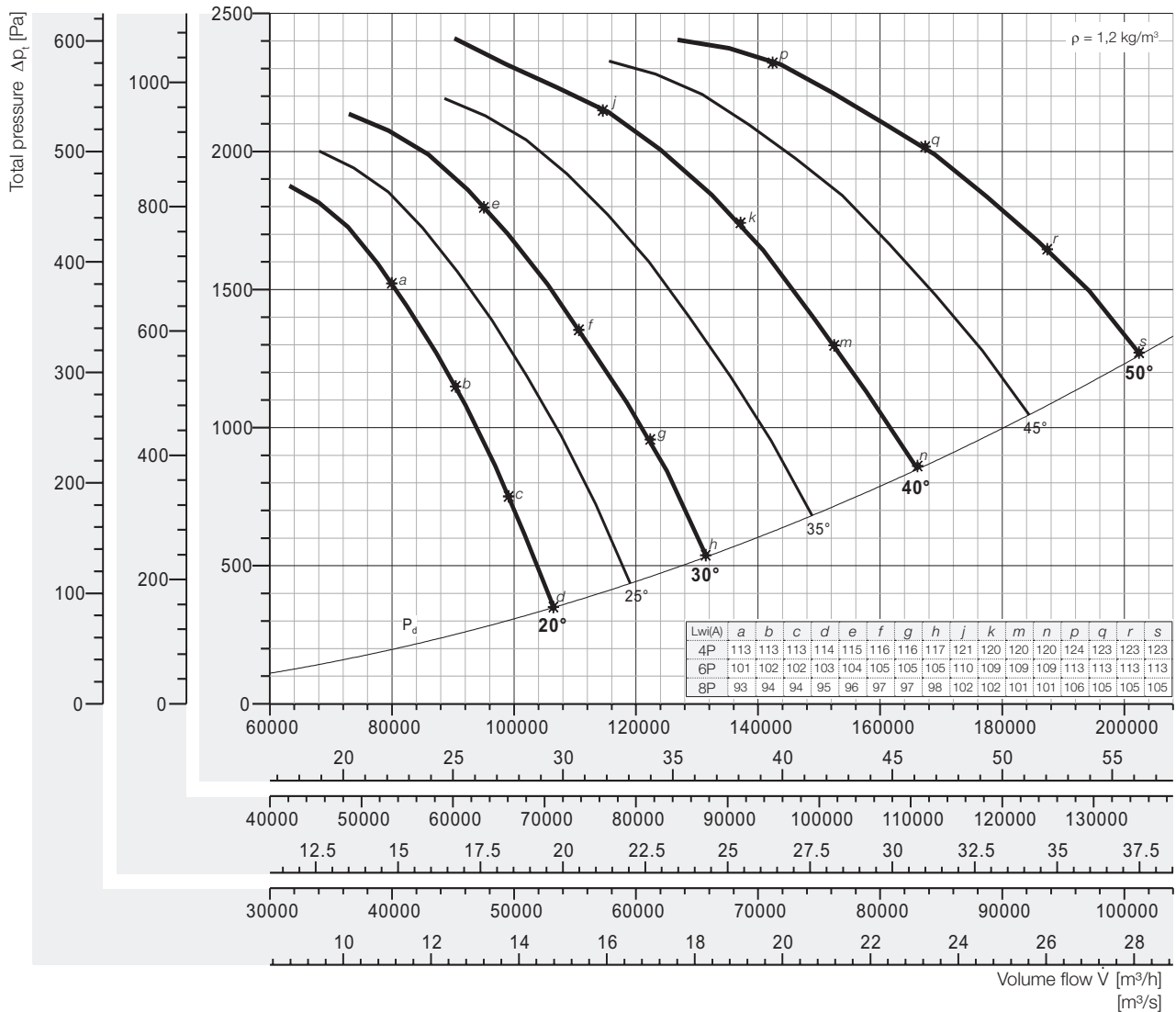
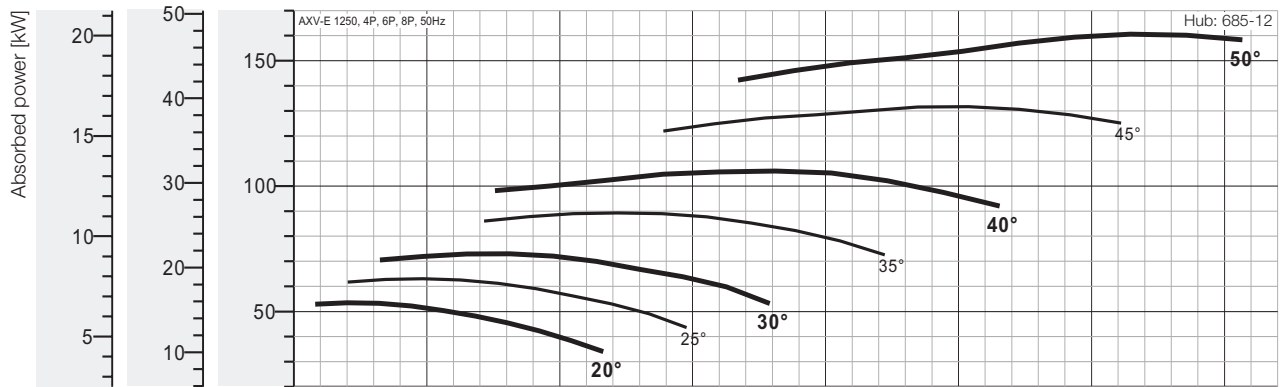

### Peak absorbed power [kW]

4-pole = 1500 rpm; 6-pole = 1000 rpm; 8-pole = 750 rpm;

N Poles	Pitch angle [°]						
	20	25	30	35	40	45	50
4P motor	53,43	63,11	72,98	89,31	106,0	131,7	160,6
6P motor	15,83	18,70	21,62	26,46	31,41	39,01	47,58
8P motor	6,68	7,89	9,12	11,16	13,25	16,46	20,07

Fan test laboratory AMCA 210/99 Fig.12, Test Chamber. Performance certified is for installation type D - Ducted inlet, Ducted outlet. Performance ratings do not include the effects of appurtenances (accessories-belt cover, pulley & belt). Power rating (kW) does not include transmission losses.

The A-weighted sound ratings shown have been calculated per AMCA International Standard 301. Values shown are for inlet Lw(A) sound power levels for installation Type D: ducted inlet, ducted outlet. Ratings include the effects of duct end correction.

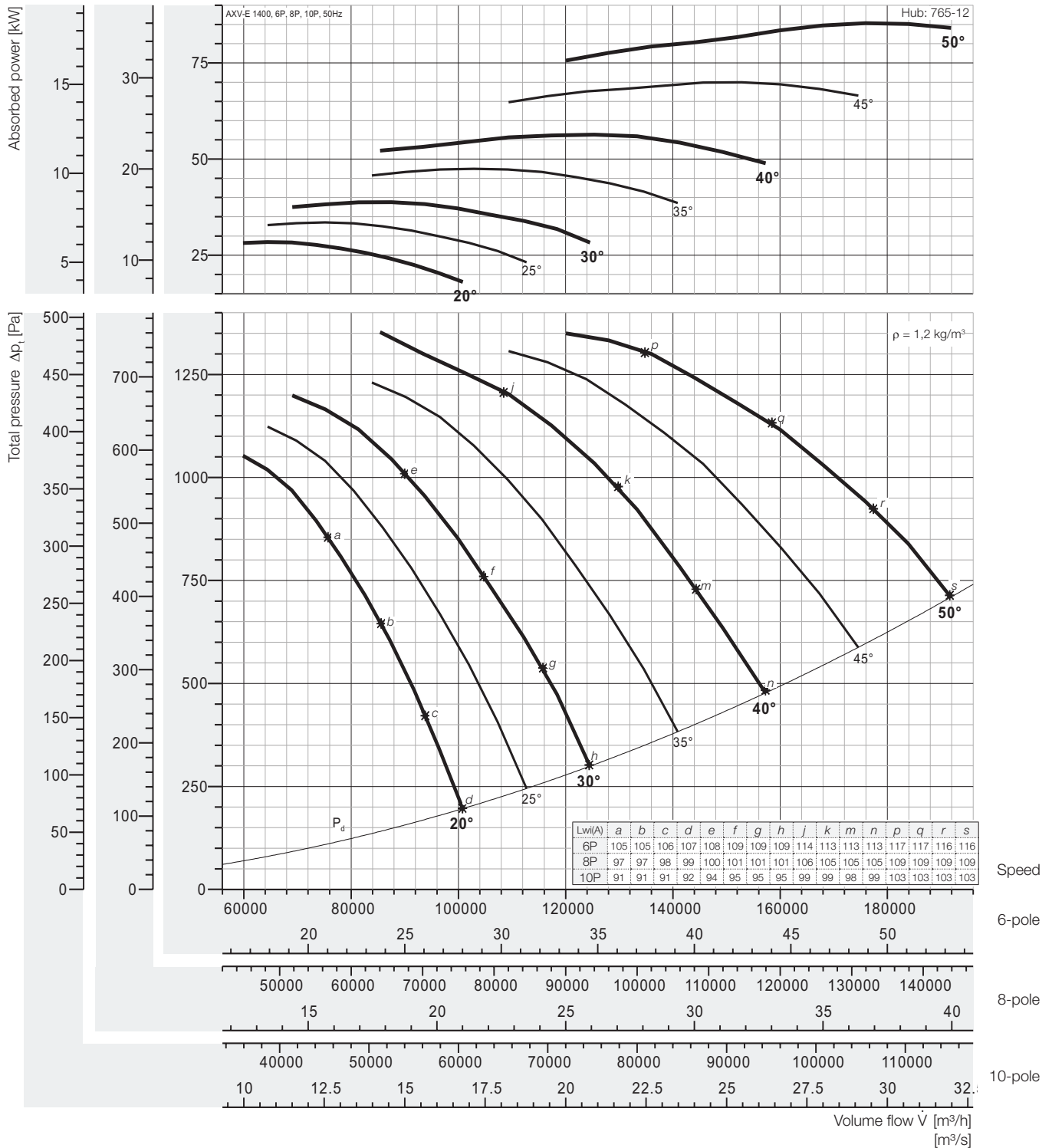

### Peak absorbed power [kW]

6-pole = 1000 rpm; 8-pole = 750 rpm; 10-pole = 600 rpm;

N Poles	Pitch angle [°]						
	20	25	30	35	40	45	50
6P motor	28,40	33,54	38,79	47,47	56,35	69,98	85,35
8P motor	11,98	14,15	16,36	20,03	23,77	29,52	36,01
10P motor	6,13	7,25	8,38	10,25	12,17	15,12	18,43

Fan test laboratory AMCA 210/99 Fig.12, Test Chamber. Performance certified is for installation type D - Ducted inlet, Ducted outlet. Performance ratings do not include the effects of appurtenances (accessories-belt cover, pulley & belt). Power rating (kW) does not include transmission losses.

The A-weighted sound ratings shown have been calculated per AMCA International Standard 301. Values shown are for inlet Lw(A) sound power levels for installation Type D: ducted inlet, ducted outlet. Ratings include the effects of duct end correction.



# Performance Curve

AXV-E 1600, 50 Hz

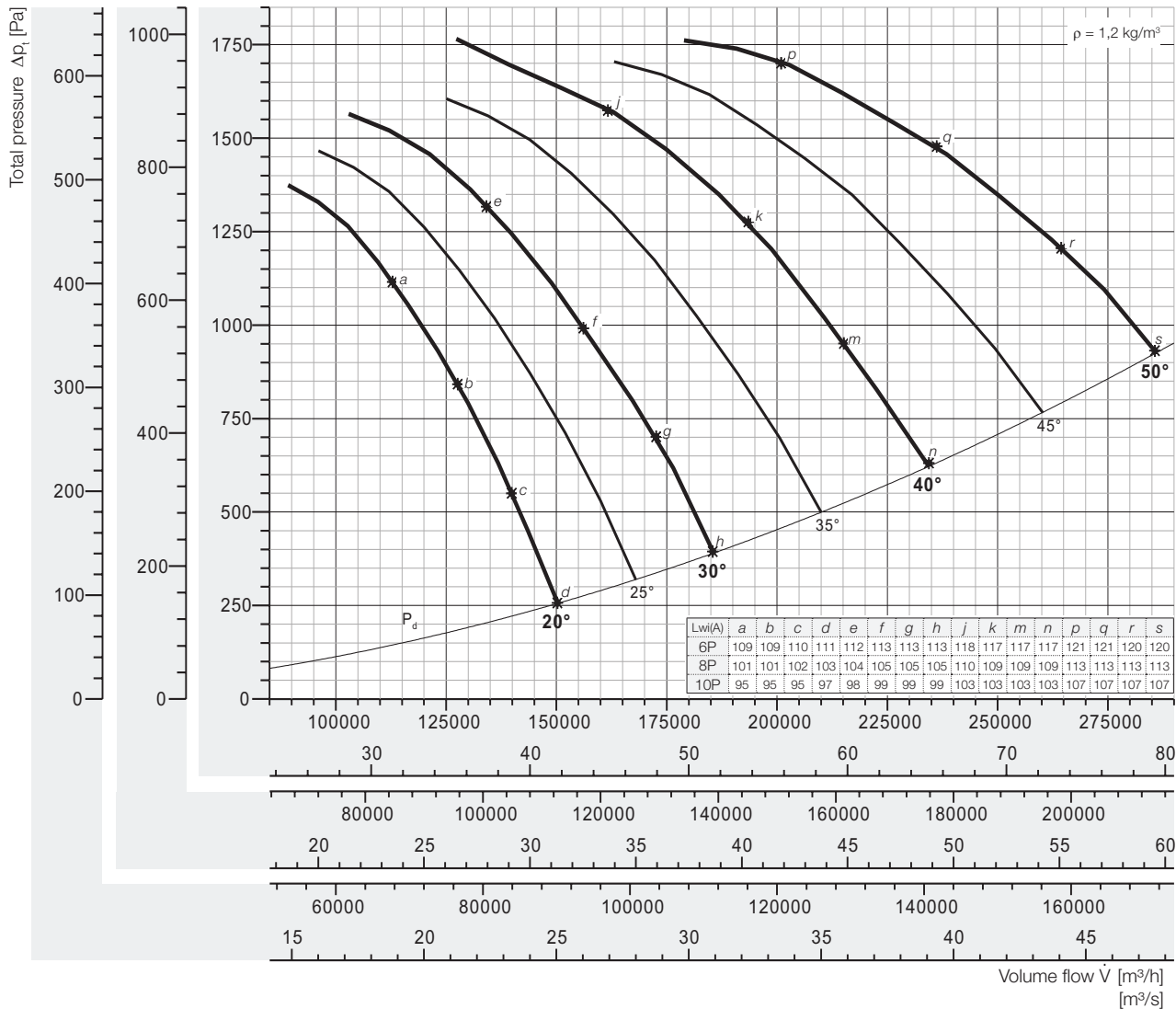
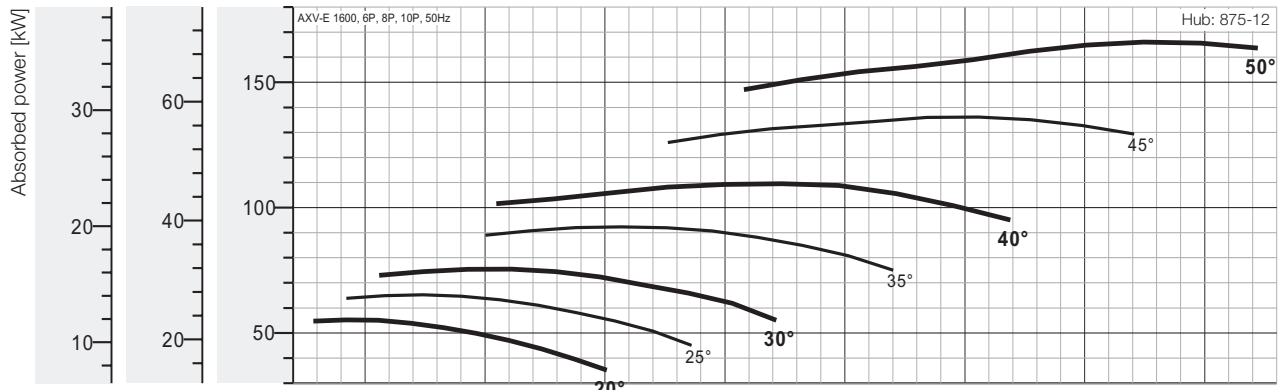

## Peak absorbed power [kW]

6-pole = 1000 rpm; 8-pole = 750 rpm; 10-pole = 600 rpm;

N Poles	Pitch angle [°]						
	20	25	30	35	40	45	50
6P motor	55,24	65,26	75,45	92,34	109,6	136,1	166,0
			90	110		160	200
8P motor	23,31	27,53	31,83	38,96	46,24	57,43	70,04
			37	45	55	75	
10P motor	11,93	14,09	16,30	19,95	23,68	29,41	35,86
			18,5	22	30		37

Fan test laboratory AMCA 210/99 Fig.12, Test Chamber. Performance certified is for installation type D - Ducted inlet, Ducted outlet. Performance ratings do not include the effects of appurtenances (accessories-belt cover, pulley & belt). Power rating (kW) does not include transmission losses.

The A-weighted sound ratings shown have been calculated per AMCA International Standard 301. Values shown are for inlet Lw(A) sound power levels for installation Type D: ducted inlet, ducted outlet. Ratings include the effects of duct end correction.



# Performance Curve

## AXV-E 1800, 50 Hz

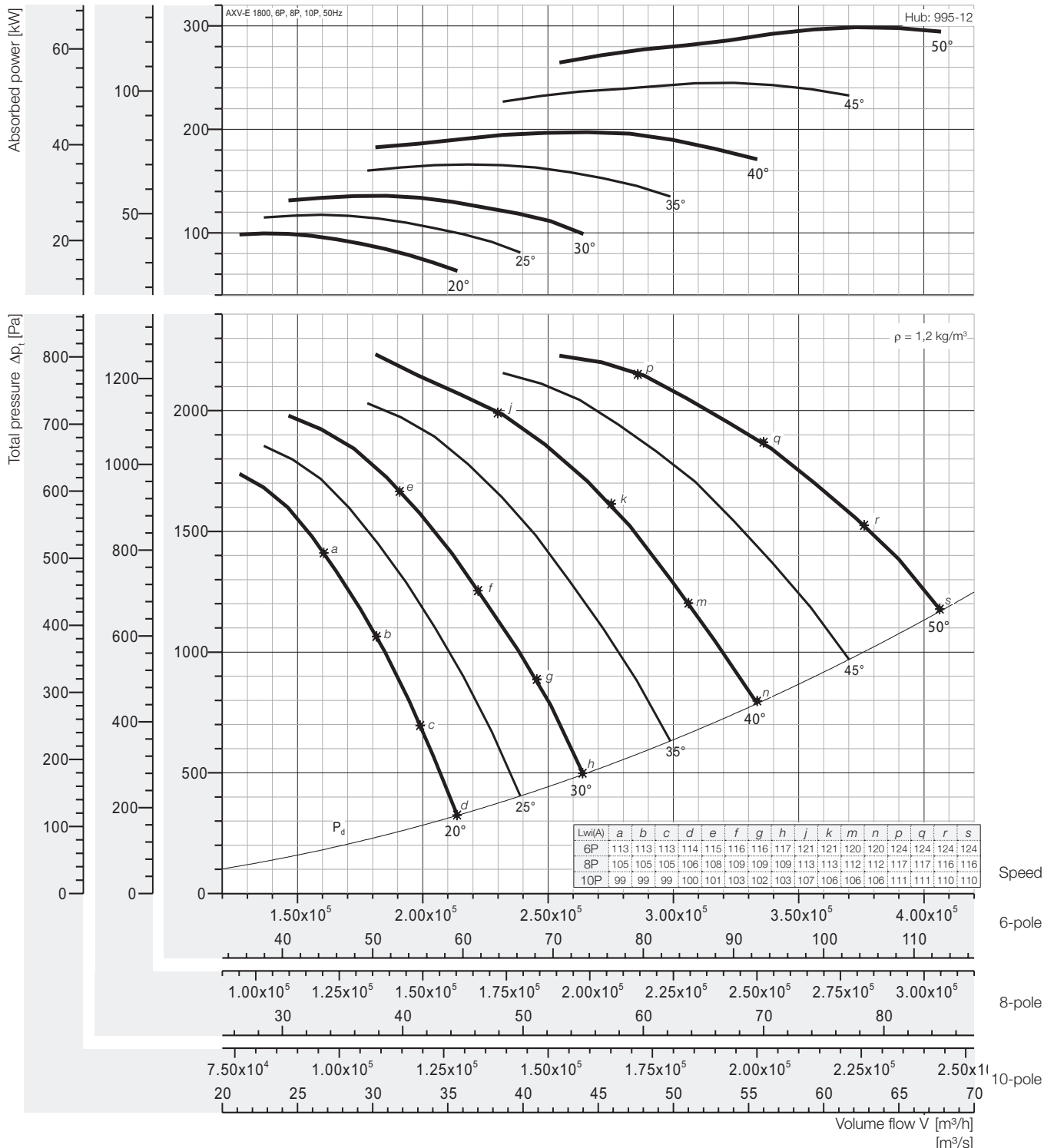

### Peak absorbed power [kW]

6-pole = 1000 rpm; 8-pole = 750 rpm; 10-pole = 600 rpm;

N Poles	Pitch angle [°]						
	20	25	30	35	40	45	50
6P motor	99,37	117,4	135,7	166,1	197,2	244,9	298,7
	110	132	160	200	250	315	
8P motor	41,92	49,52	57,26	70,01	83,18	103,3	126,0
	45	55	75	90	110	132	
10P motor	21,46	25,36	29,32	35,88	42,59	52,90	64,51
	22	30	37	45	55	75	

Fan test laboratory AMCA 210/99 Fig.12, Test Chamber. Performance certified is for installation type D - Ducted inlet, Ducted outlet. Performance ratings do not include the effects of appurtenances (accessories-belt cover, pulley & belt). Power rating (kW) does not include transmission losses.

The A-weighted sound ratings shown have been calculated per AMCA International Standard 301. Values shown are for inlet Lw(A) sound power levels for installation Type D: ducted inlet, ducted outlet. Ratings include the effects of duct end correction.



# Performance Curve

## AXV-E 2000, 50 Hz

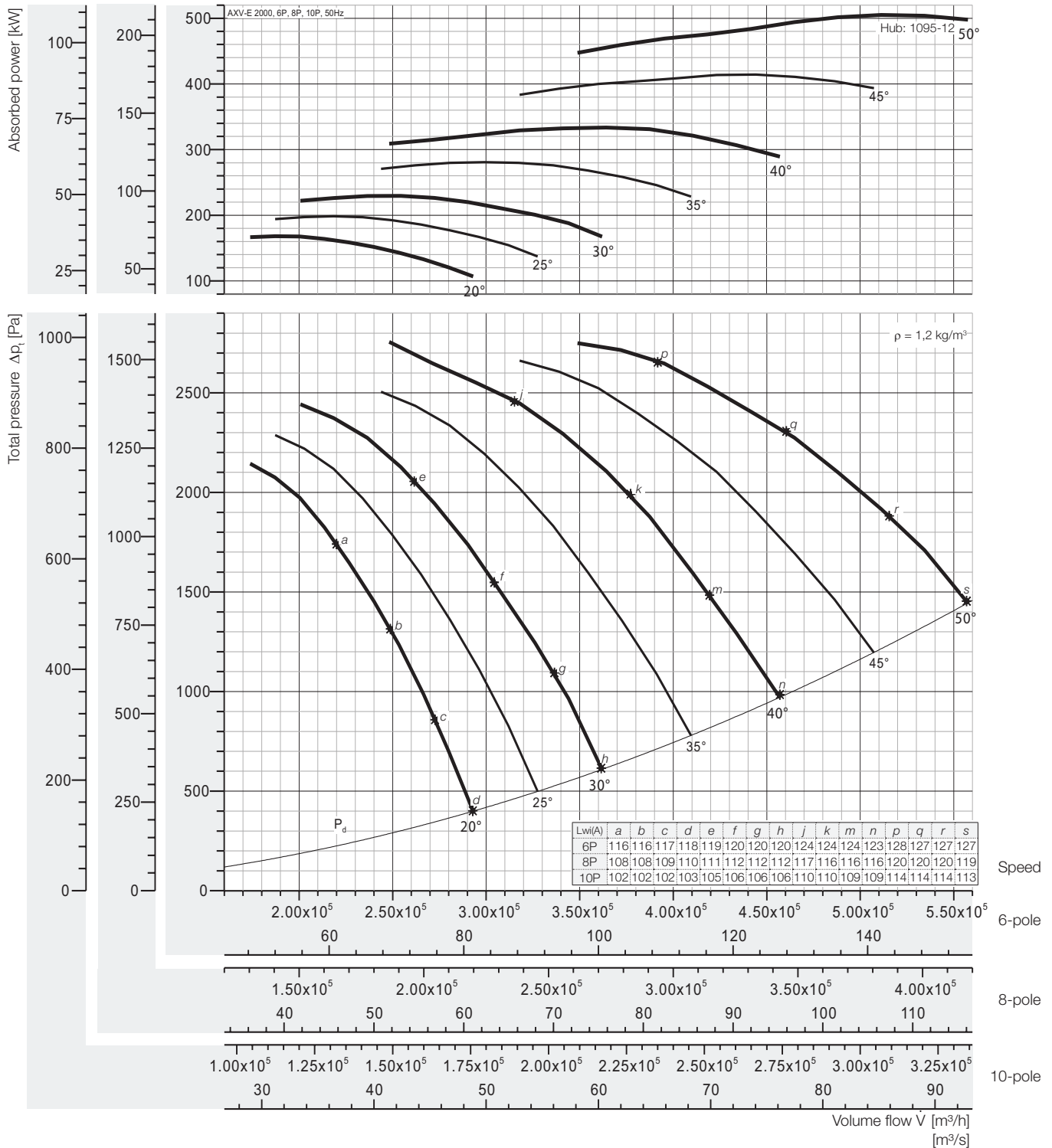

### Peak absorbed power [kW]

6-pole = 1000 rpm; 8-pole = 750 rpm; 10-pole = 600 rpm;

N Poles	Pitch angle [°]						
	20	25	30	35	40	45	50
6P motor	168,1	198,5	229,5	280,9	333,4	414,1	505,1
	200		250	315	355	450	560
8P motor	70,90	83,75	96,84	118,5	140,7	174,7	213,1
	75	90	110	132	160	200	250
10P motor	36,30	42,88	49,58	60,68	72,03	89,46	109,1
	37	45	55	75		90	110

Fan test laboratory AMCA 210/99 Fig.12, Test Chamber. Performance certified is for installation type D - Ducted inlet, Ducted outlet. Performance ratings do not include the effects of appurtenances (accessories-belt cover, pulley & belt). Power rating (kW) does not include transmission losses.

The A-weighted sound ratings shown have been calculated per AMCA International Standard 301. Values shown are for inlet Lw(A) sound power levels for installation Type D: ducted inlet, ducted outlet. Ratings include the effects of duct end correction.

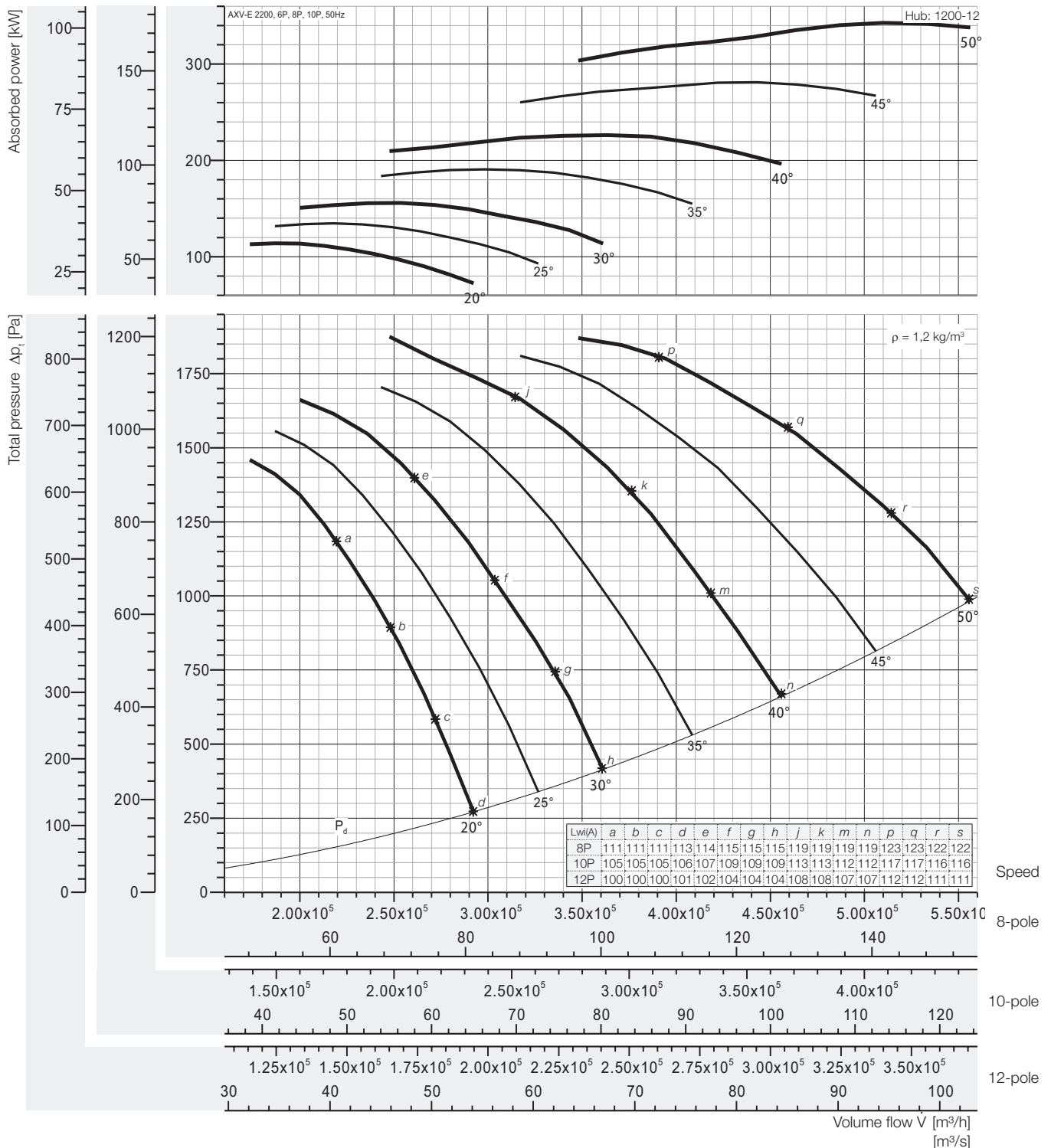

Peak absorbed power [kW]

8-pole = 750 rpm; 10-pole = 600 rpm; 12-pole = 500 rpm;

N Poles	Pitch angle [°]						
	20	25	30	35	40	45	50
8P motor	114,1 132	134,7 160	155,8	190,6 200	226,3 250	281,1 315	342,8 355
10P motor	58,40 75	68,98	79,76 90	97,61 110	115,9 132	143,9 160	175,5 200
12P motor	33,79 37	39,92 45	46,16 55	56,49 75	67,05	83,28 90	101,6 110

Fan test laboratory AMCA 210/99 Fig.12, Test Chamber. Performance certified is for installation type D - Ducted inlet, Ducted outlet. Performance ratings do not include the effects of appurtenances (accessories-belt cover, pulley & belt). Power rating (kW) does not include transmission losses.

The A-weighted sound ratings shown have been calculated per AMCA International Standard 301. Values shown are for inlet Lw(A) sound power levels for installation Type D: ducted inlet, ducted outlet. Ratings include the effects of duct end correction.





# Performance Curve

## AXV-E 2400, 50 Hz

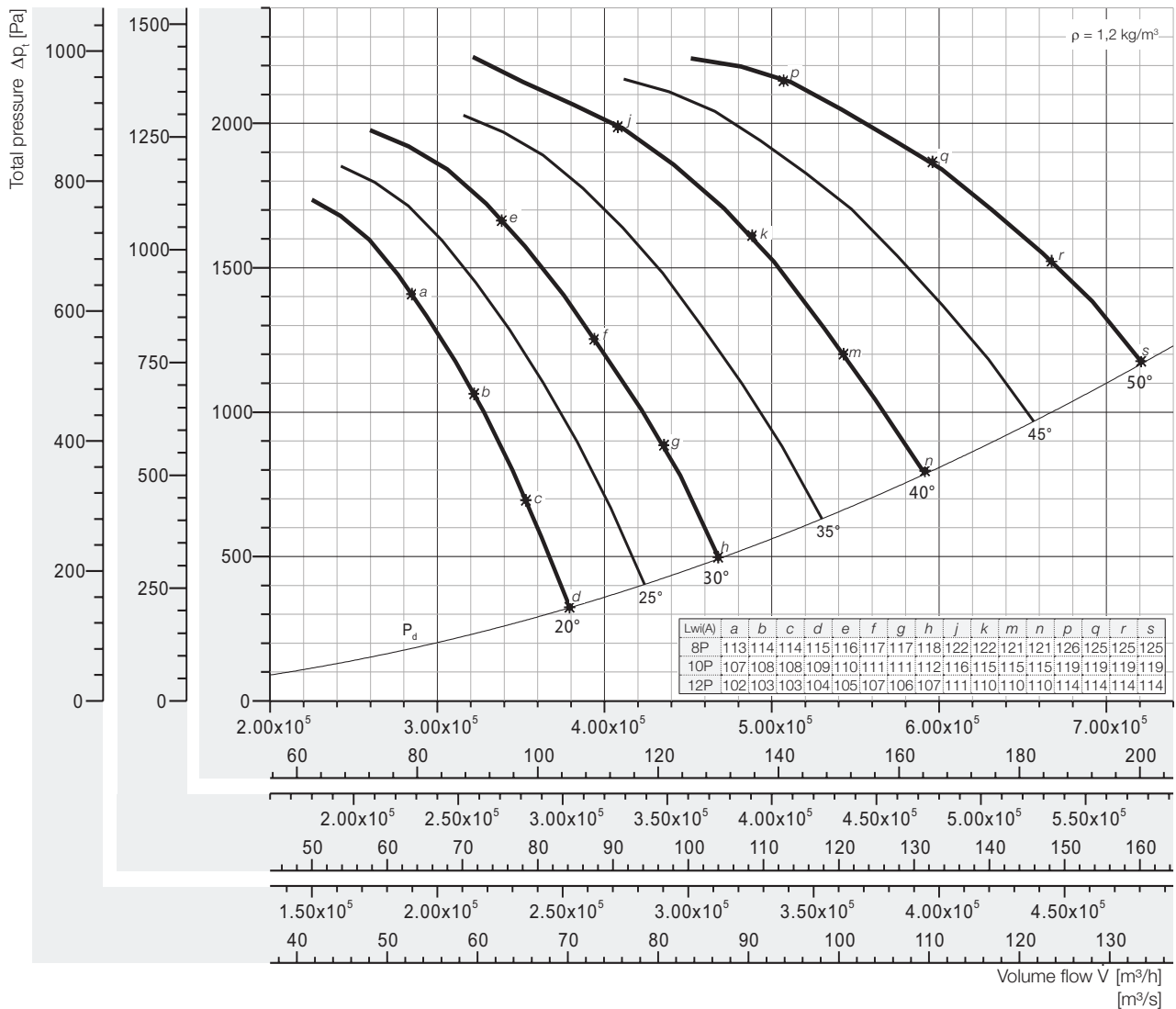
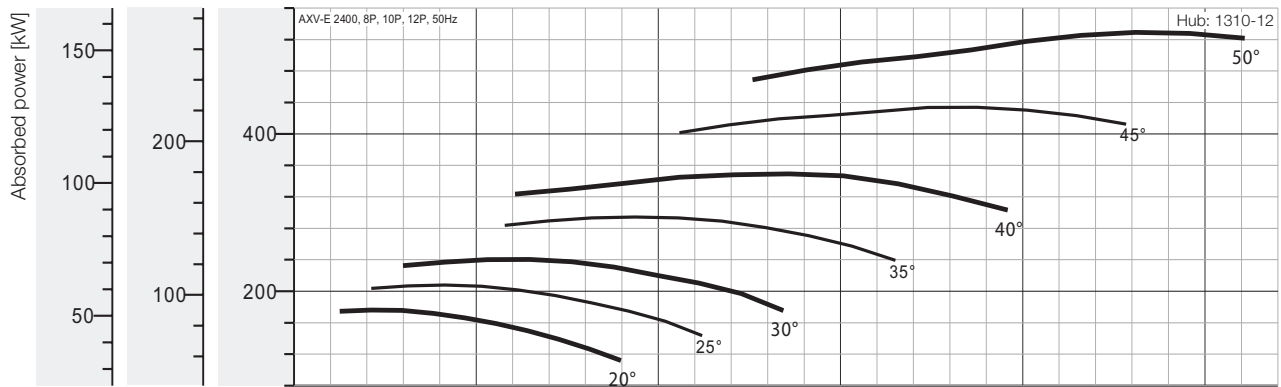

### Peak absorbed power [kW]

8-pole = 750 rpm; 10-pole = 600 rpm; 12-pole = 500 rpm;

N Poles	Pitch angle [°]						
	20	25	30	35	40	45	50
8P motor	176,1	208,0	240,5	294,3	349,3	433,8	529,1
10P motor	90,14	106,5	123,1	150,7	178,9	222,1	270,9
12P motor	52,16	61,62	71,25	87,20	103,50	128,55	156,78

Fan test laboratory AMCA 210/99 Fig.12, Test Chamber. Performance certified is for installation type D - Ducted inlet, Ducted outlet. Performance ratings do not include the effects of appurtenances (accessories-belt cover, pulley & belt). Power rating (kW) does not include transmission losses.

The A-weighted sound ratings shown have been calculated per AMCA International Standard 301. Values shown are for inlet Lw(A) sound power levels for installation Type D: ducted inlet, ducted outlet. Ratings include the effects of duct end correction.

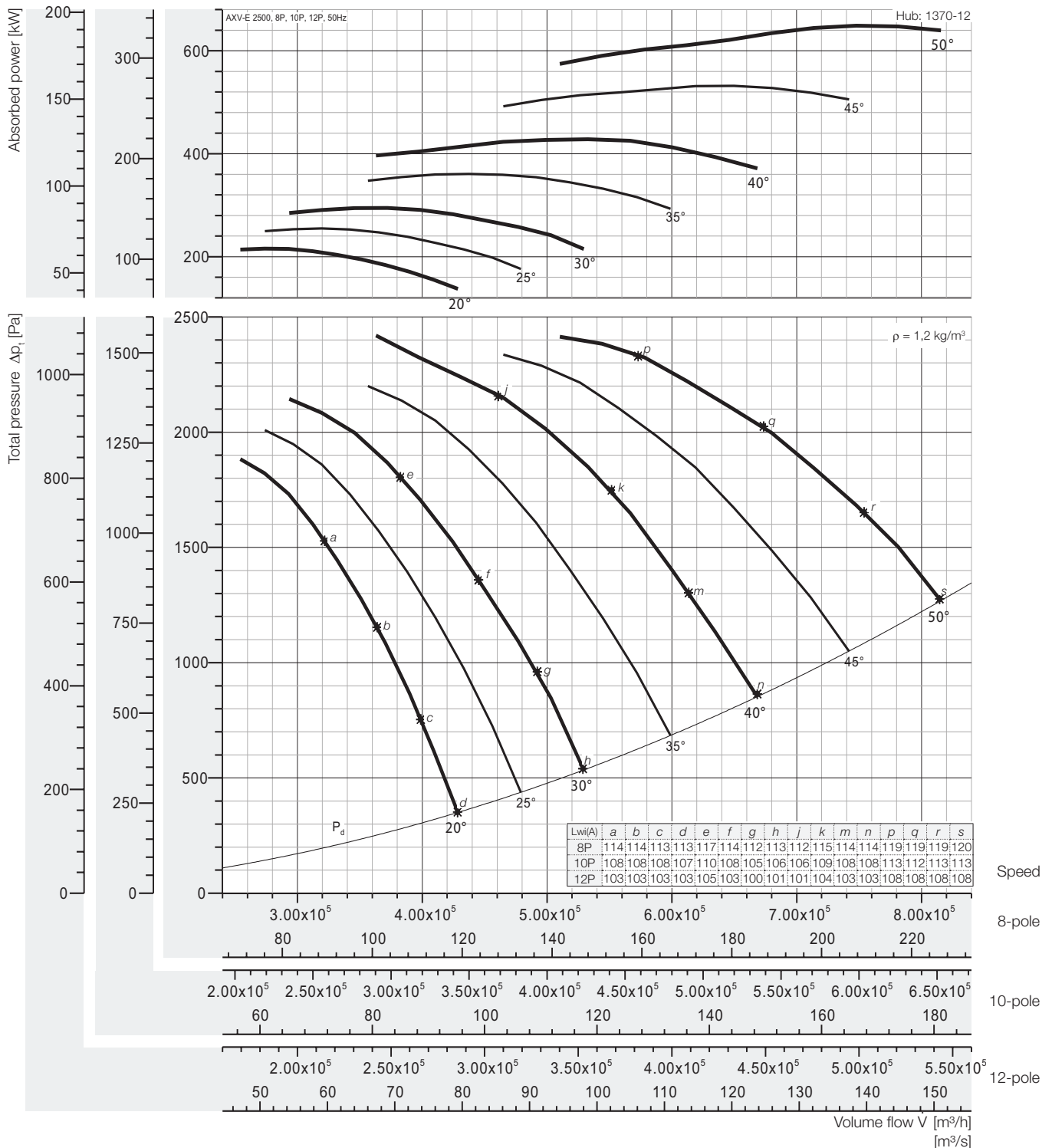

### Peak absorbed power [kW]

8-pole = 750 rpm; 10-pole = 600 rpm; 12-pole = 500 rpm;

N Poles	Pitch angle [°]						
	20	25	30	35	40	45	50
8P motor	215,8 250	254,9 315	294,8	360,8 400	428,2 450	531,9 560	648,7 710
10P motor	110,0 110	130,5 132	150,9 160	184,7 200	219,3 250	272,3 315	332,1 355
12P motor	63,95 75	75,54 90	87,35	106,9 110	126,9 132	157,6 160	192,2 200

Fan test laboratory AMCA 210/99 Fig.12, Test Chamber. Performance certified is for installation type D - Ducted inlet, Ducted outlet. Performance ratings do not include the effects of appurtenances (accessories-belt cover, pulley & belt). Power rating (kW) does not include transmission losses.

The A-weighted sound ratings shown have been calculated per AMCA International Standard 301. Values shown are for inlet Lw(A) sound power levels for installation Type D: ducted inlet, ducted outlet. Ratings include the effects of duct end correction.



# Performance Curve

## AXV-E 2600, 50 Hz

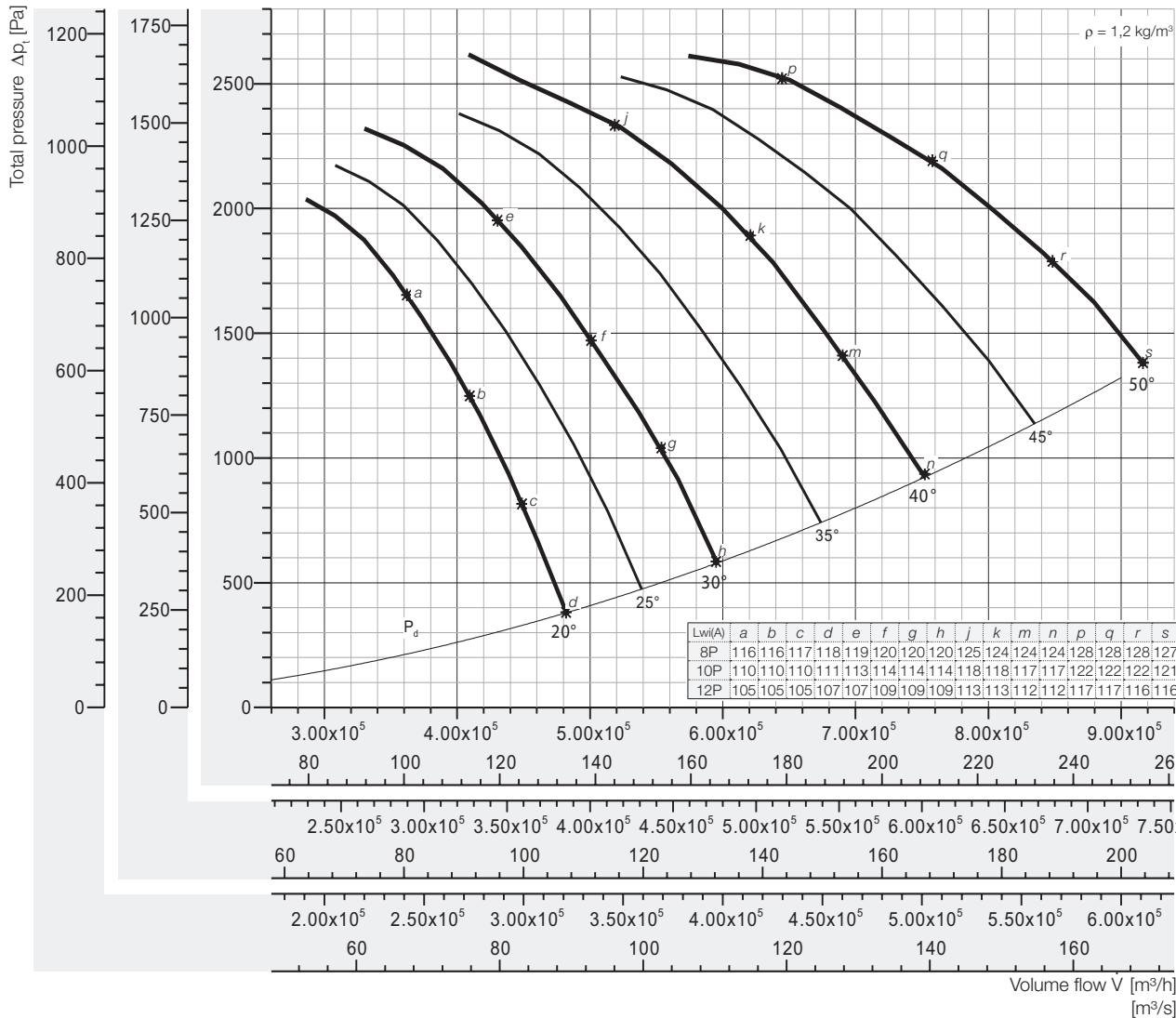
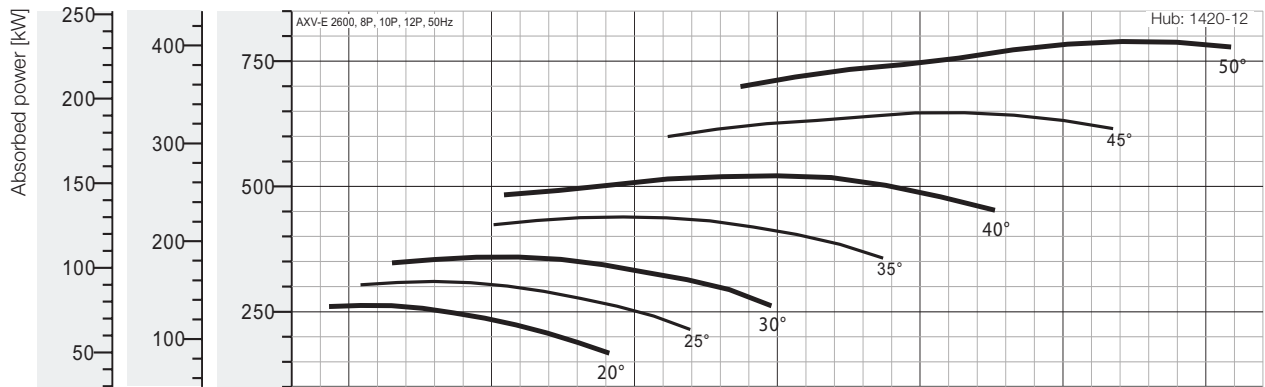

Speed  
8-pole  
10-pole  
12-pole

### Peak absorbed power [kW]

8-pole = 750 rpm; 10-pole = 600 rpm; 12-pole = 500 rpm;

N Poles	Pitch angle [°]						
	20	25	30	35	40	45	50
8P motor	262,7	310,4	358,9	439,2	521,3	647,5	789,7
10P motor	134,5	158,9	183,7	224,9	266,9	331,5	404,3
12P motor	77,85	91,96	106,3	130,1	154,5	191,8	234,0

Fan test laboratory AMCA 210/99 Fig.12, Test Chamber. Performance certified is for installation type D - Ducted inlet, Ducted outlet. Performance ratings do not include the effects of appurtenances (accessories-belt cover, pulley & belt). Power rating (kW) does not include transmission losses.

The A-weighted sound ratings shown have been calculated per AMCA International Standard 301. Values shown are for inlet Lw(A) sound power levels for installation Type D: ducted inlet, ducted outlet. Ratings include the effects of duct end correction.

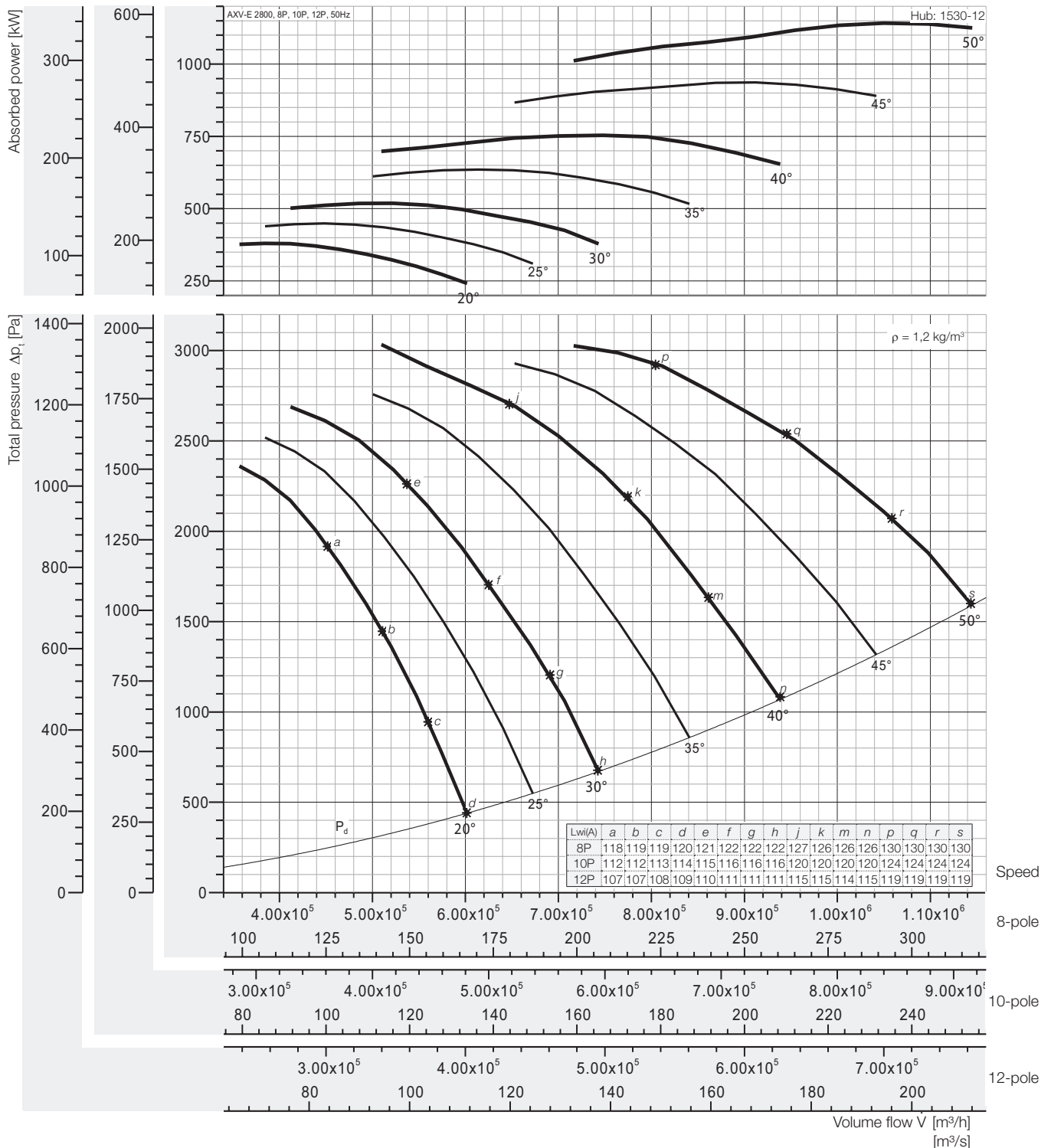

### Peak absorbed power [kW]

8-pole = 750 rpm; 10-pole = 600 rpm; 12-pole = 500 rpm;

N Poles	Pitch angle [°]						
	20	25	30	35	40	45	50
8P motor	380,0 400	448,8 450	519,0 560	635,1 710	753,9 -	936,3 -	1142 -
10P motor	194,5 200	229,8 250	265,7 315	325,2 355	386,0 400	479,4 560	584,7 630
12P motor	112,6 132	133,0 160	153,8	188,2 200	223,4 250	277,4 315	338,4 355

Fan test laboratory AMCA 210/99 Fig.12, Test Chamber. Performance certified is for installation type D - Ducted inlet, Ducted outlet. Performance ratings do not include the effects of appurtenances (accessories-belt cover, pulley & belt). Power rating (kW) does not include transmission losses.

The A-weighted sound ratings shown have been calculated per AMCA International Standard 301. Values shown are for inlet Lw(A) sound power levels for installation Type D: ducted inlet, ducted outlet. Ratings include the effects of duct end correction.



Certified FEGs are determined in accordance with AMCA 205-12 Energy Efficiency Classification for fans. In conjunction with AMCA 211-13 (Rev. 2015) Certified Ratings Program, Product Rating Manual for Fan Air Performance. This classification is based on fan peak (optimum) total efficiency for a given fan speed, fan size and application category. For the purpose of energy classification, the peak efficiency can be determined at a speed not higher than the maximum design speed of the fan.

The AMCA Certified Ratings Seal applies to the Fan Efficiency Grade (FEG) for AXV-E series Axial Fan model AXV-E 800 to AXV-E 2800 as shown in the table below.

Fan Model No.	Fan Speed (rpm)	Fan Outlet Area (m <sup>2</sup> )	Fan Efficiency Grades	Fan Model No.	Fan Speed (rpm)	Fan Outlet Area (m <sup>2</sup> )	Fan Efficiency Grade
AXV-E 800	1800/1200/900	0,4989	FEG60	AXV-E 1800	1200/900/720	2,5588	FEG67
AXV-E 900	1800/1200/900	0,6277	FEG63	AXV-E 2000	1200/900/720	3,1573	FEG67
AXV-E 1000	1800/1200/900	0,7901	FEG67	AXV-E 2200	900/720/600	3,8186	FEG67
AXV-E 1120	1800/1200/900	0,9940	FEG67	AXV-E 2400	900/720/600	4,5428	FEG67
AXV-E 1250	1800/1200/900	1,2272	FEG67	AXV-E 2500	900/720/600	4,9284	FEG67
AXV-E 1400	1200/900/720	1,5504	FEG67	AXV-E 2600	900/720/600	5,3297	FEG67
AXV-E 1600	1200/900/720	2,0232	FEG67	AXV-E 2800	900/720/600	6,1795	FEG67

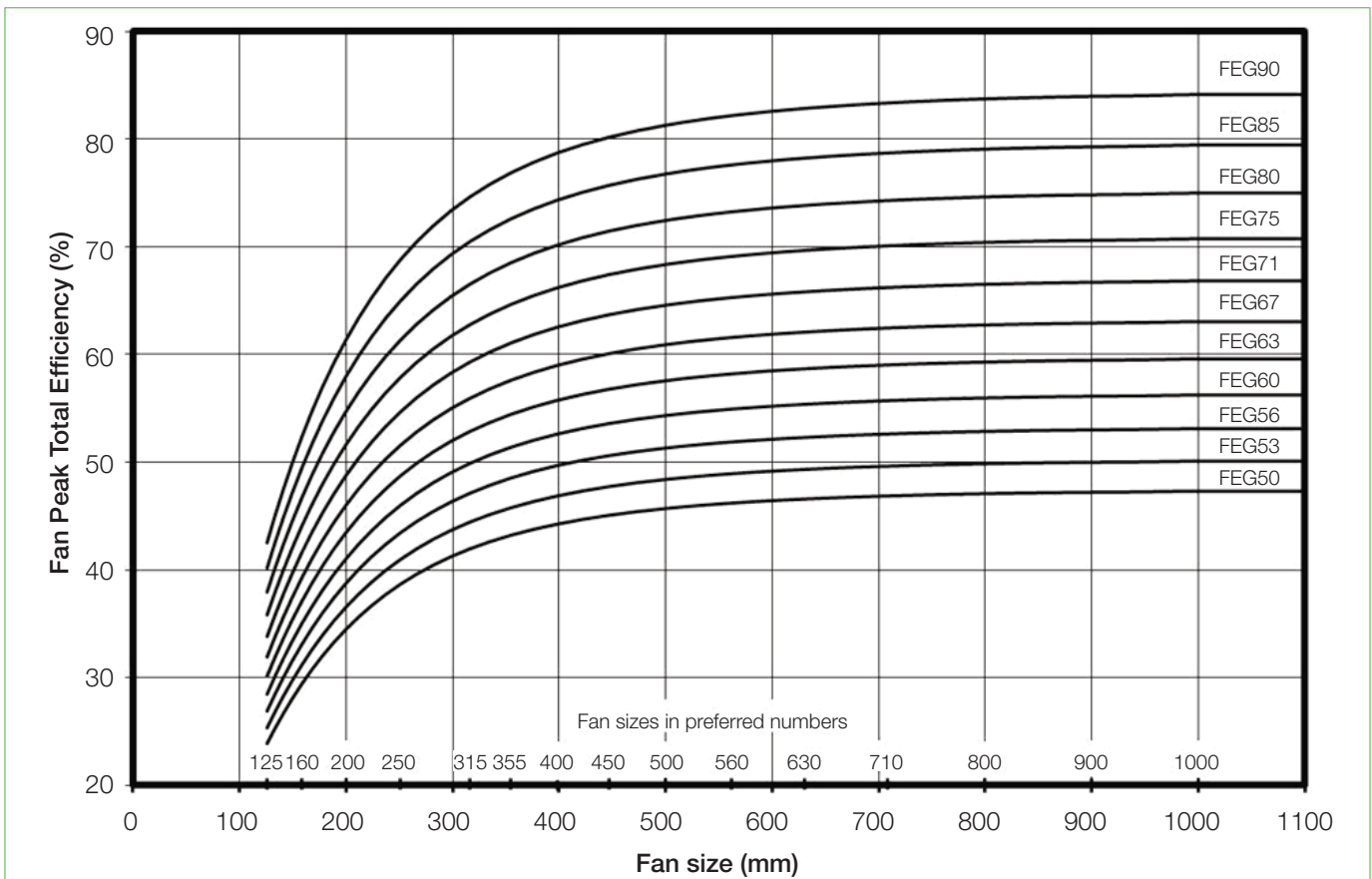

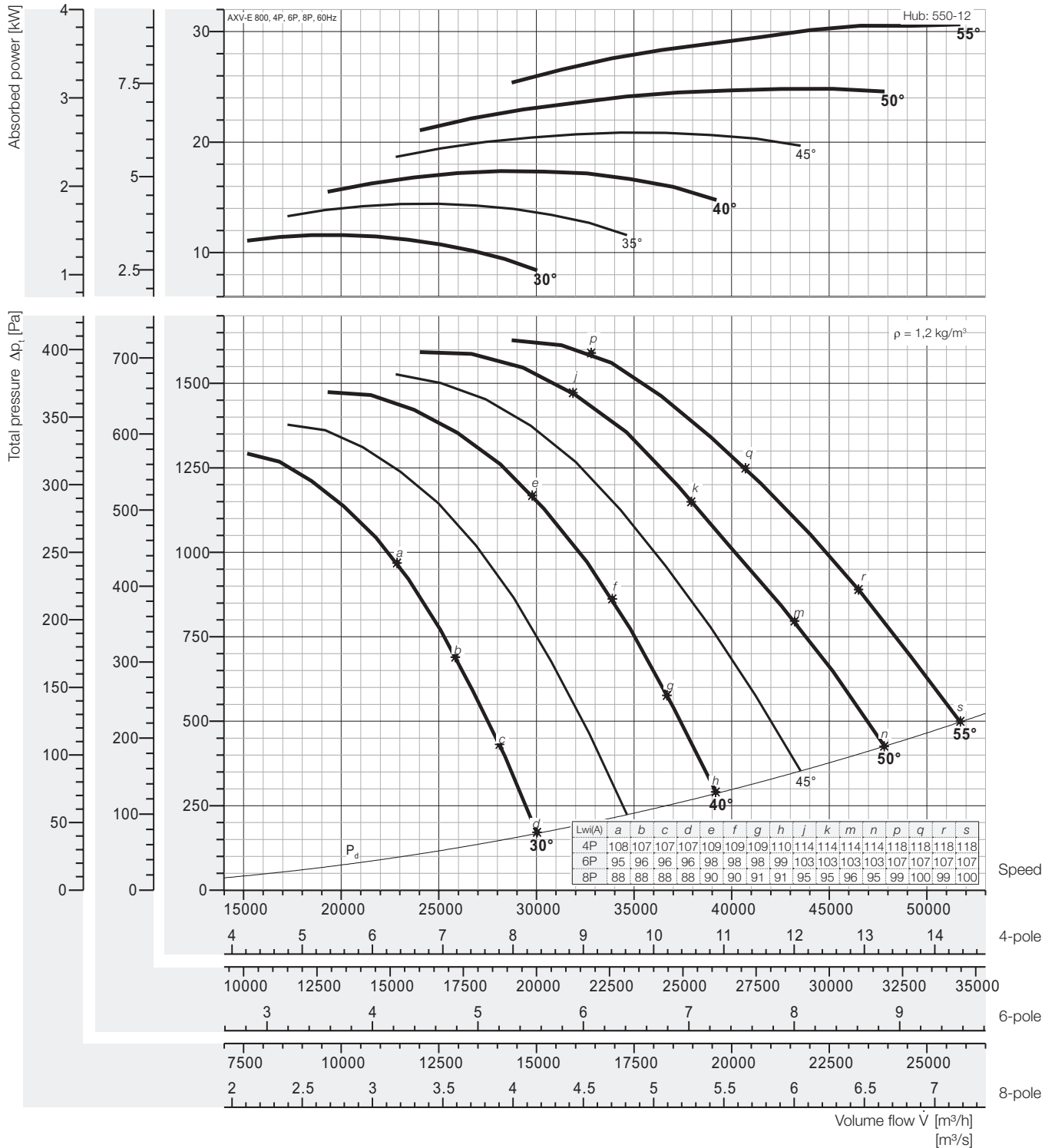

### Peak absorbed power [kW]

4-pole = 1800 rpm; 6-pole = 1200 rpm; 8-pole = 900 rpm;

N Poles	Pitch angle [°]						
	25	30	35	40	45	50	55
4P	-	11,58	14,42	17,37	20,86	24,82	30,65
Motor	-	15		18,5	22	30	37
6P	-	3,43	4,27	5,15	6,18	7,35	9,08
Motor	-	4	5,5	7,5			11
8P	-	1,45	1,80	2,17	2,61	3,10	3,83
Motor	-	1,5	2,2		3	4	

Fan test laboratory AMCA 210/99 Fig.12, Test Chamber. Performance certified is for installation type D - Ducted inlet, Ducted outlet. Performance ratings do not include the effects of appurtenances (accessories-belt cover, pulley & belt). Power rating (kW) does not include transmission losses.

The A-weighted sound ratings shown have been calculated per AMCA International Standard 301. Values shown are for inlet Lw(A) sound power levels for installation Type D: ducted inlet, ducted outlet. Ratings include the effects of duct end correction.



# Performance Curve

## AXV-E 900, 60 Hz

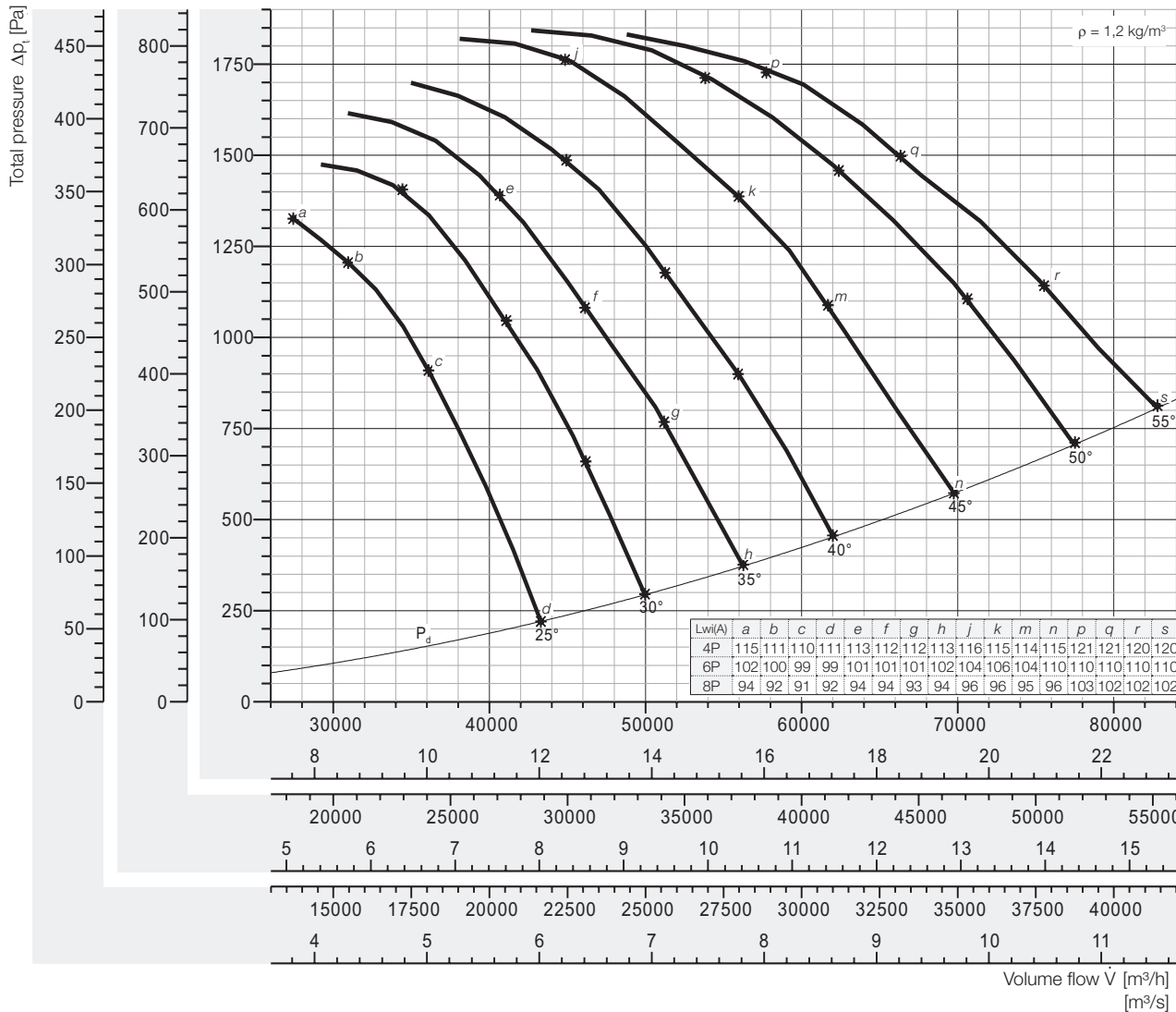
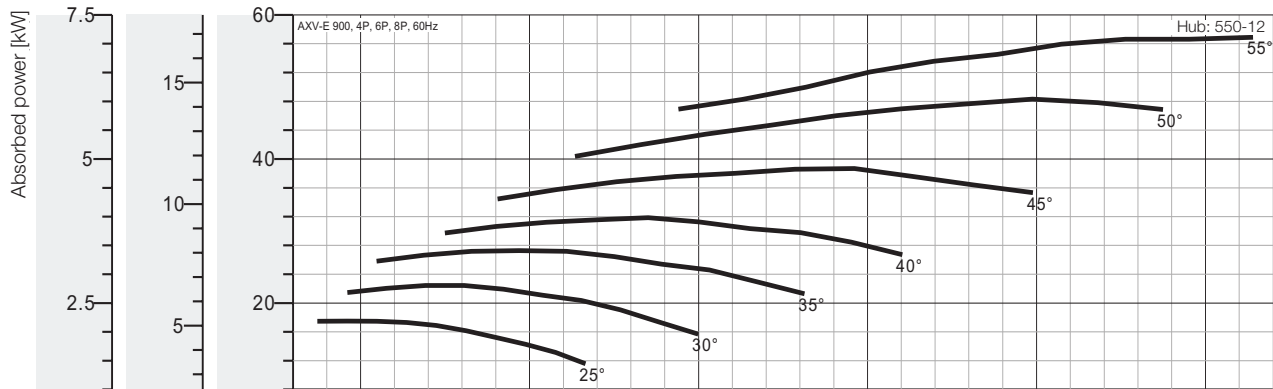

### Peak absorbed power [kW]

4-pole = 1800 rpm; 6-pole = 1200 rpm; 8-pole = 900 rpm;

N Poles	Pitch angle [°]						
	25	30	35	40	45	50	55
4P motor	17,51	22,43	27,29	31,86	38,67	48,32	56,90
6P motor	5,19	6,65	8,08	9,44	11,46	14,32	16,86
8P motor	2,19	2,80	3,41	3,98	4,83	6,04	7,11

Fan test laboratory AMCA 210/99 Fig.12, Test Chamber. Performance certified is for installation type D - Ducted inlet, Ducted outlet. Performance ratings do not include the effects of appurtenances (accessories-belt cover, pulley & belt). Power rating (kW) does not include transmission losses.

The A-weighted sound ratings shown have been calculated per AMCA International Standard 301. Values shown are for inlet Lw(A) sound power levels for installation Type D: ducted inlet, ducted outlet. Ratings include the effects of duct end correction.



# Performance Curve

## AXV-E 1000, 60 Hz

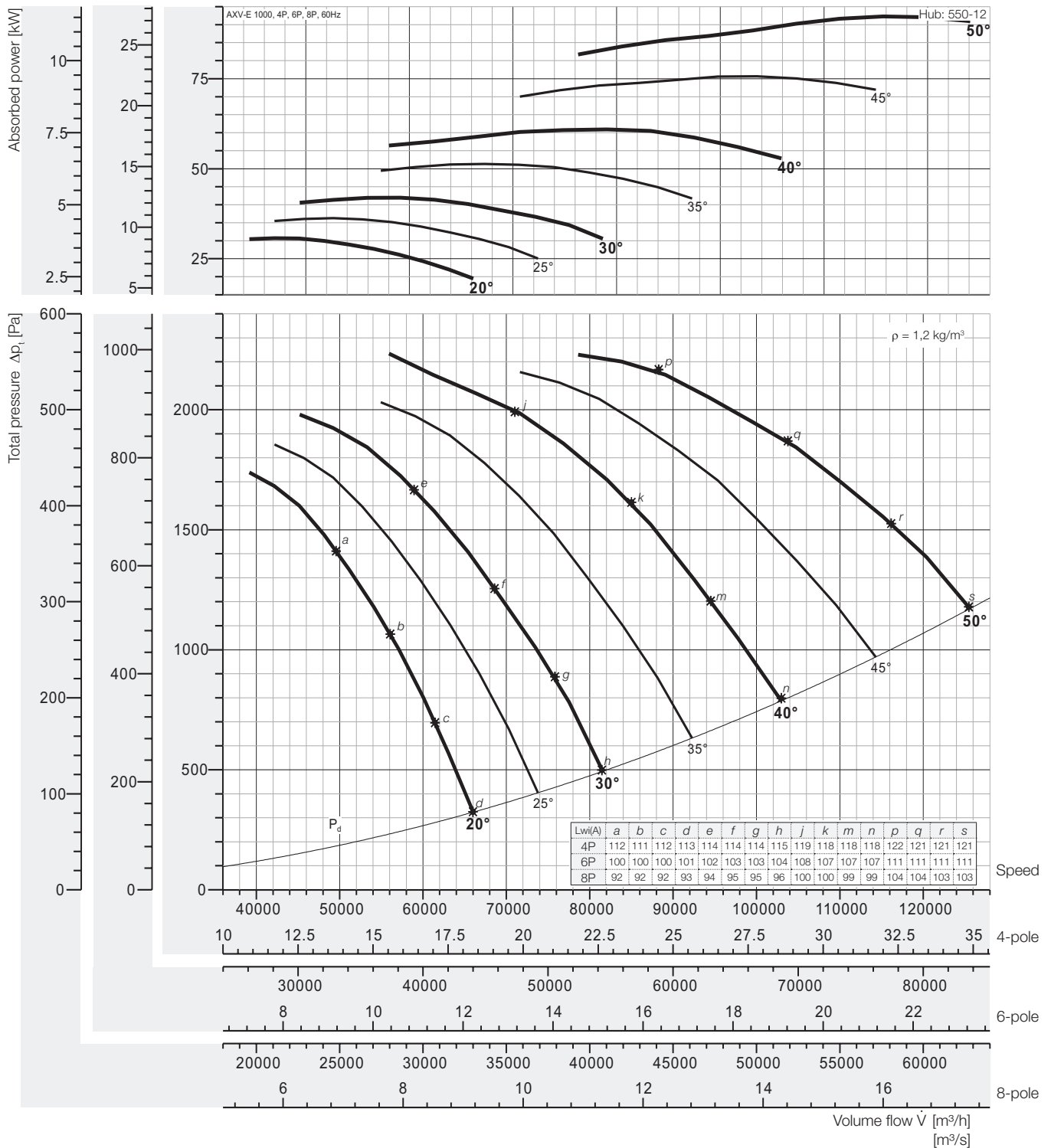

### Peak absorbed power [kW]

4-pole = 1800 rpm; 6-pole = 1200 rpm; 8-pole = 900 rpm;

N Poles	Pitch angle [°]						
	20	25	30	35	40	45	50
4P motor	30,71	36,27	41,94	51,33	60,92	75,67	92,28
6P motor	9,10	10,75	12,43	15,21	18,05	22,42	27,34
8P motor	3,84	4,53	5,24	6,42	7,62	9,46	11,54

Fan test laboratory AMCA 210/99 Fig.12, Test Chamber. Performance certified is for installation type D - Ducted inlet, Ducted outlet. Performance ratings do not include the effects of appurtenances (accessories-belt cover, pulley & belt). Power rating (kW) does not include transmission losses.

The A-weighted sound ratings shown have been calculated per AMCA International Standard 301. Values shown are for inlet Lw(A) sound power levels for installation Type D: ducted inlet, ducted outlet. Ratings include the effects of duct end correction.





# Performance Curve

## AXV-E 1120, 60 Hz

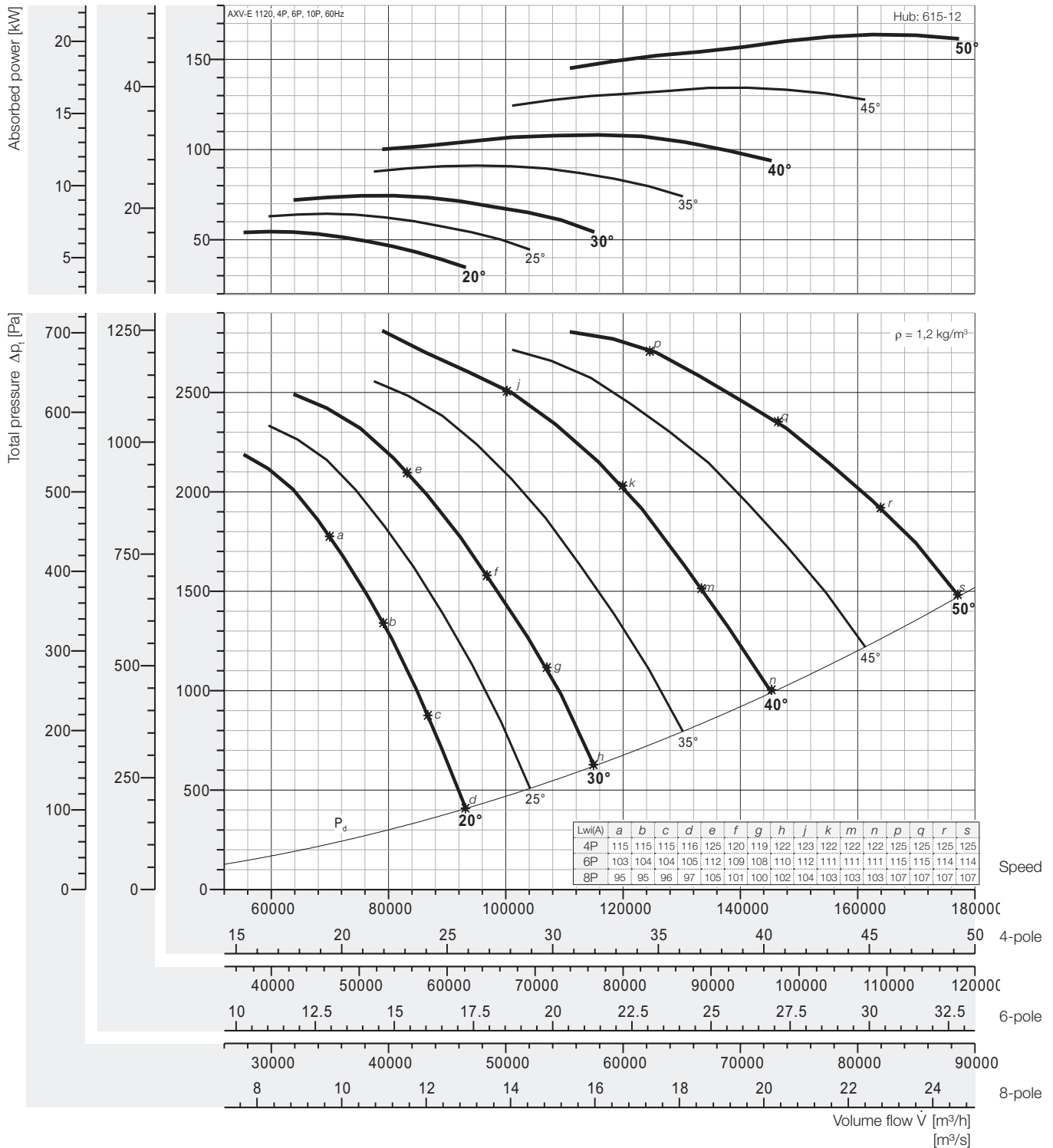

### Peak absorbed power [kW]

4-pole = 1800 rpm; 6-pole = 1200 rpm; 8-pole = 900 rpm;

N Poles	Pitch angle [°]						
	20	25	30	35	40	45	50
4P motor	54,51	64,39	74,46	91,12	108,2	134,3	163,8
	55	75		110		160	200
6P motor	16,15	19,08	22,06	27,00	32,05	39,80	48,54
	18,5	22	30		37	45	55
8P motor	6,81	8,05	9,31	11,39	13,52	16,79	20,48
	7,5	11		15		18,5	22

Fan test laboratory AMCA 210/99 Fig.12, Test Chamber. Performance certified is for installation type D - Ducted inlet, Ducted outlet. Performance ratings do not include the effects of appurtenances (accessories-belt cover, pulley & belt). Power rating (kW) does not include transmission losses.

The A-weighted sound ratings shown have been calculated per AMCA International Standard 301. Values shown are for inlet Lw(A) sound power levels for installation Type D: ducted inlet, ducted outlet. Ratings include the effects of duct end correction.



# Performance Curve

## AXV-E 1250, 60 Hz

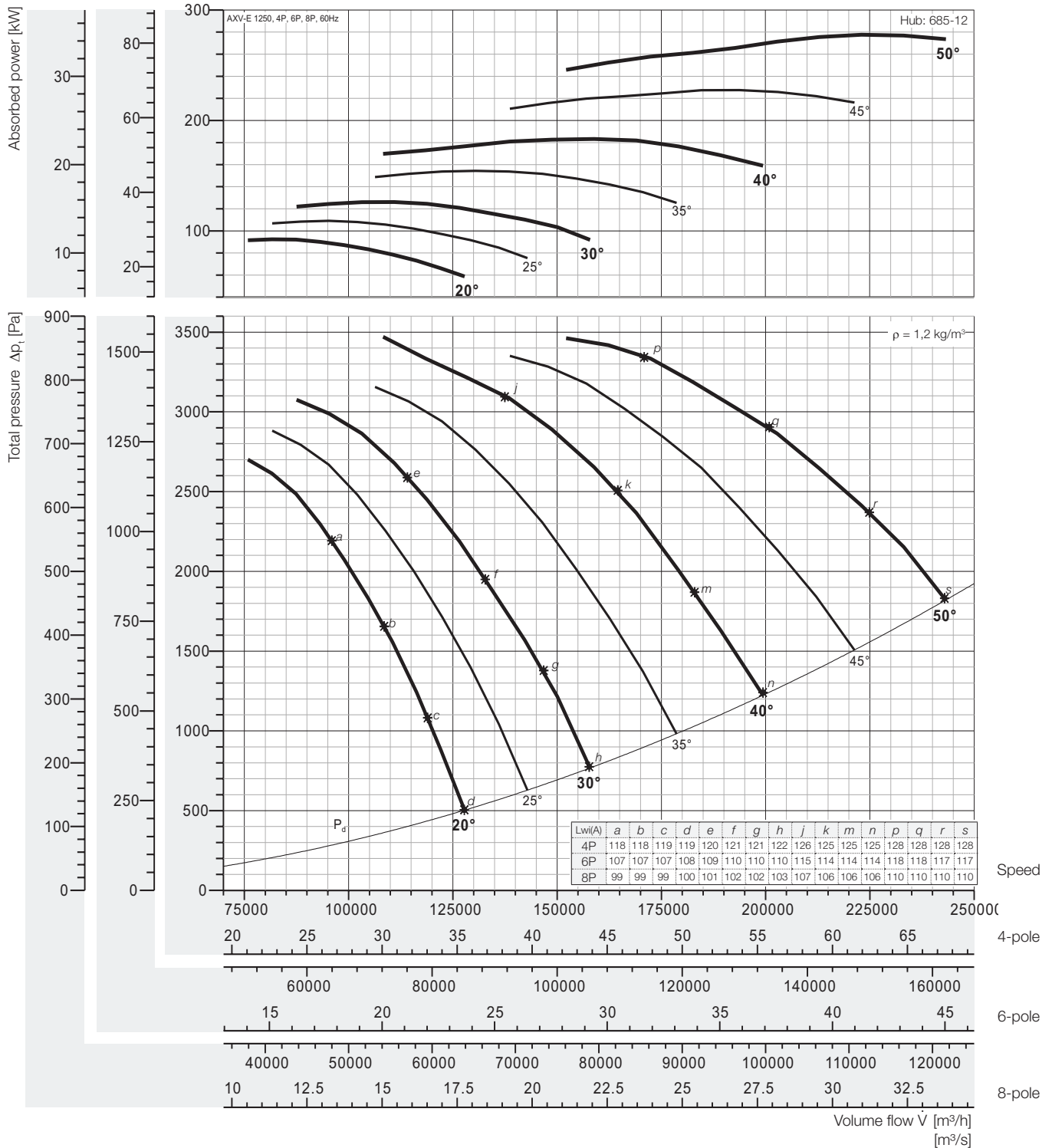

### Peak absorbed power [kW]

4-pole = 1800 rpm; 6-pole = 1200 rpm; 8-pole = 900 rpm;

N Poles	Pitch angle [°]						
	20	25	30	35	40	45	50
4P motor	92,32	109,1	126,1	154,3	183,2	227,5	277,5
	110		132	160	200	250	315
6P motor	27,36	32,31	37,36	45,73	54,28	67,41	82,22
	30	37	45	55		75	90
8P motor	11,54	13,63	15,76	19,29	22,90	28,44	34,68
	15		18,5	22	30		37

Fan test laboratory AMCA 210/99 Fig.12, Test Chamber. Performance certified is for installation type D - Ducted inlet, Ducted outlet. Performance ratings do not include the effects of appurtenances (accessories-belt cover, pulley & belt). Power rating (kW) does not include transmission losses.

The A-weighted sound ratings shown have been calculated per AMCA International Standard 301. Values shown are for inlet Lw(A) sound power levels for installation Type D: ducted inlet, ducted outlet. Ratings include the effects of duct end correction.



# Performance Curve

AXV-E 1400, 60 Hz

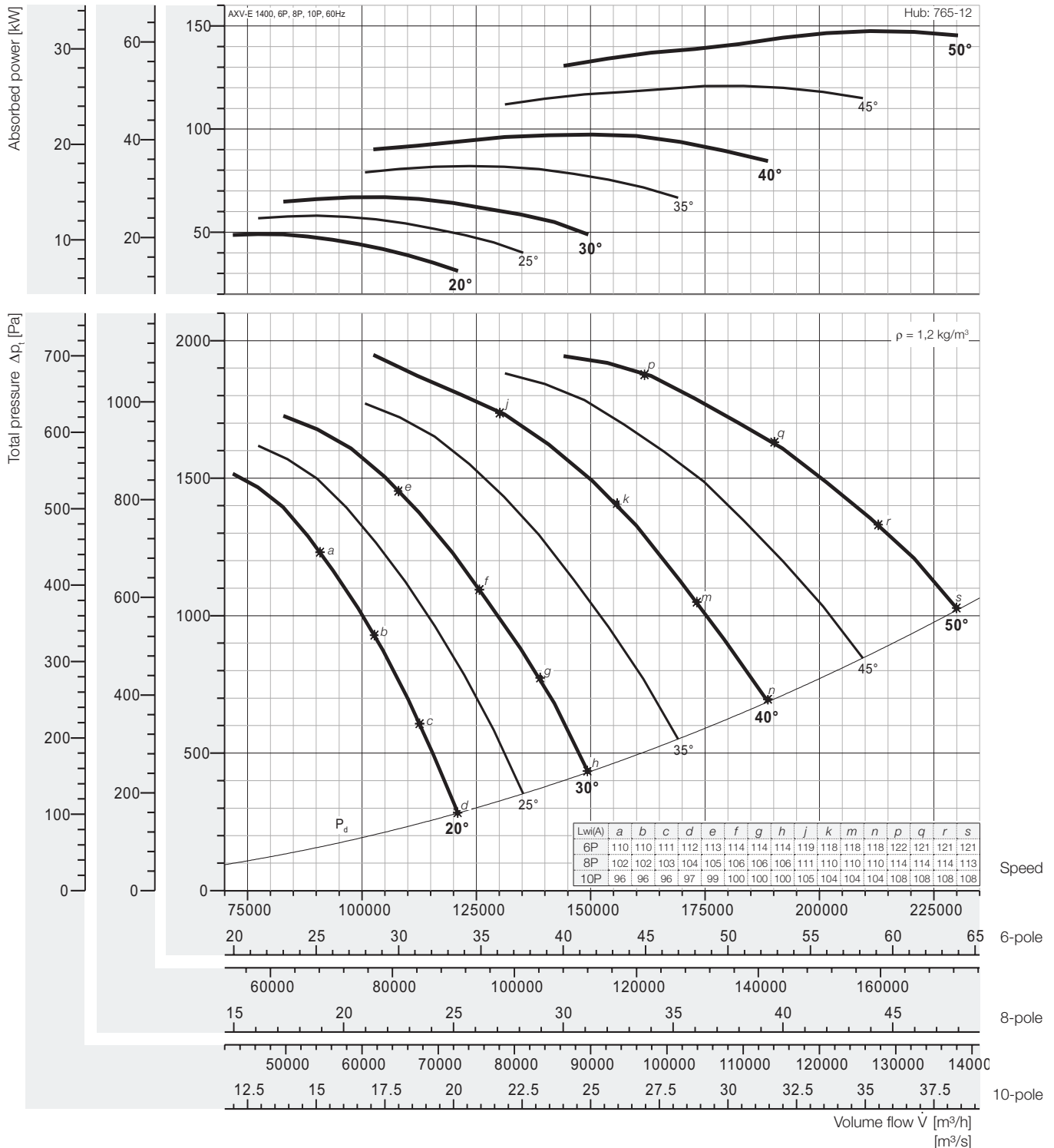

## Peak absorbed power [kW]

6-pole = 1200 rpm; 8-pole = 900 rpm; 10-pole = 720 rpm;

N Poles	Pitch angle [°]						
	20	25	30	35	40	45	50
6P motor	49,07	57,97	67,02	82,03	97,37	120,9	147,5
8P motor	20,70	24,45	28,28	34,61	41,08	51,02	62,22
10P motor	10,60	12,52	14,48	17,72	21,03	26,12	31,86

Fan test laboratory AMCA 210/99 Fig.12, Test Chamber. Performance certified is for installation type D - Ducted inlet, Ducted outlet. Performance ratings do not include the effects of appurtenances (accessories-belt cover, pulley & belt). Power rating (kW) does not include transmission losses.

The A-weighted sound ratings shown have been calculated per AMCA International Standard 301. Values shown are for inlet Lw(A) sound power levels for installation Type D: ducted inlet, ducted outlet. Ratings include the effects of duct end correction.



# Performance Curve

## AXV-E 1600, 60 Hz

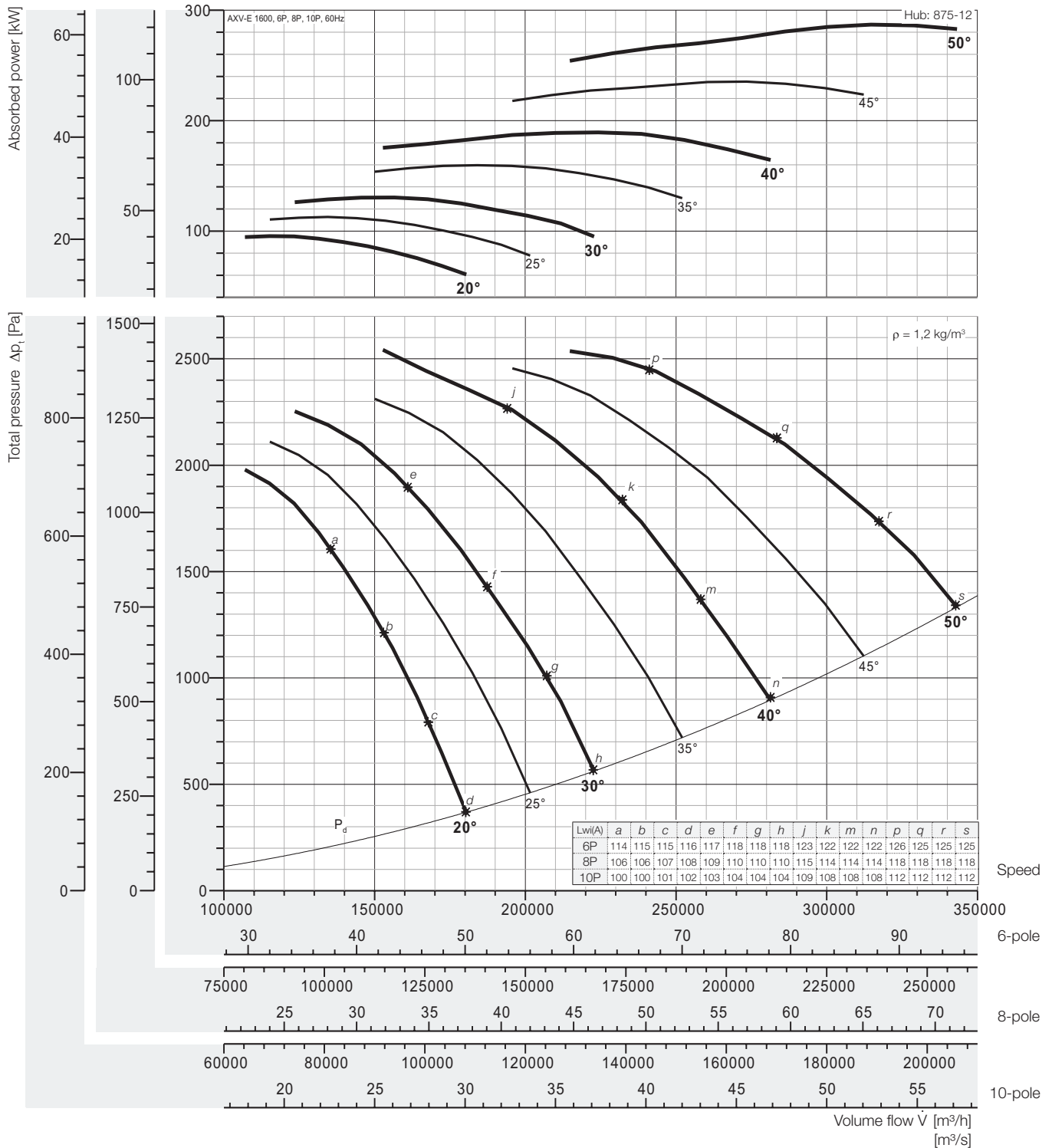

### Peak absorbed power [kW]

6-pole = 1200 rpm; 8-pole = 900 rpm; 10-pole = 720 rpm;

N Poles	Pitch angle [°]						
	20	25	30	35	40	45	50
6P motor	95,46	112,8	130,4	159,6	189,4	235,2	286,9
	110	132		160	200	250	315
8P motor	40,27	47,57	55,00	67,32	79,91	99,24	121,0
	45	55		75	90	110	132
10P motor	20,62	24,36	28,16	34,47	40,91	50,81	61,97
	22	30		37	45	55	75

Fan test laboratory AMCA 210/99 Fig.12, Test Chamber. Performance certified is for installation type D - Ducted inlet, Ducted outlet. Performance ratings do not include the effects of appurtenances (accessories-belt cover, pulley & belt). Power rating (kW) does not include transmission losses.

The A-weighted sound ratings shown have been calculated per AMCA International Standard 301. Values shown are for inlet Lw(A) sound power levels for installation Type D: ducted inlet, ducted outlet. Ratings include the effects of duct end correction.



# Performance Curve

AXV-E 1800, 60 Hz

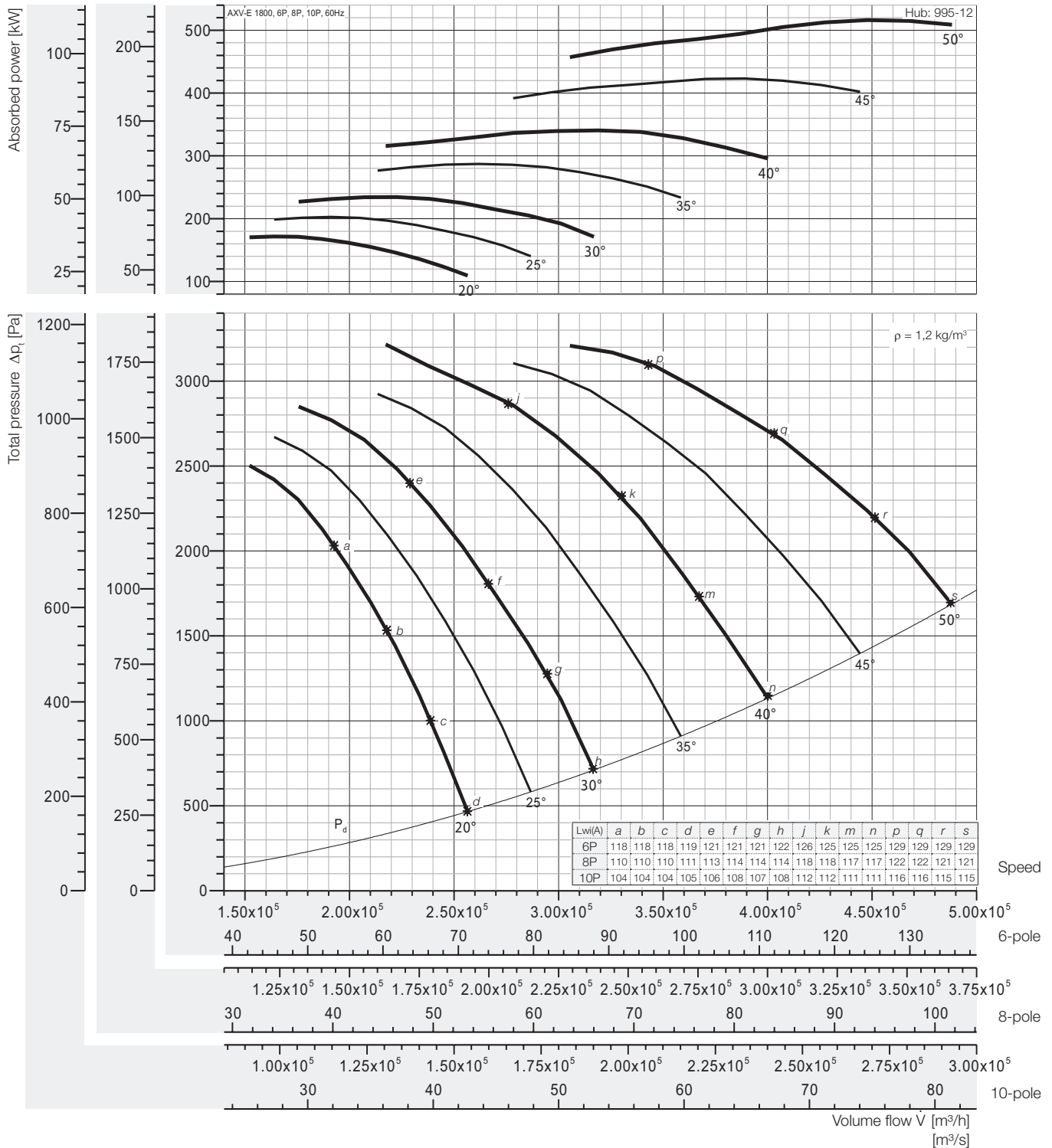

## Peak absorbed power [kW]

6-pole = 1200 rpm; 8-pole = 900 rpm; 10-pole = 720 rpm;

N Poles	Pitch angle [°]						
	20	25	30	35	40	45	50
6P motor	171,7	202,8	234,5	287,0	340,7	423,2	516,1
	200	250		315	355	450	560
8P motor	72,44	85,58	98,95	121,1	143,7	178,5	217,7
	75	90	110	132	160	200	250
10P motor	37,00	43,82	50,66	62,00	73,60	91,40	111,5
	37	45	55	75		110	132

Fan test laboratory AMCA 210/99 Fig.12, Test Chamber. Performance certified is for installation type D - Ducted inlet, Ducted outlet. Performance ratings do not include the effects of appurtenances (accessories-belt cover, pulley & belt). Power rating (kW) does not include transmission losses.

The A-weighted sound ratings shown have been calculated per AMCA International Standard 301. Values shown are for inlet LwiA sound power levels for installation Type D: ducted inlet, ducted outlet. Ratings include the effects of duct end correction.

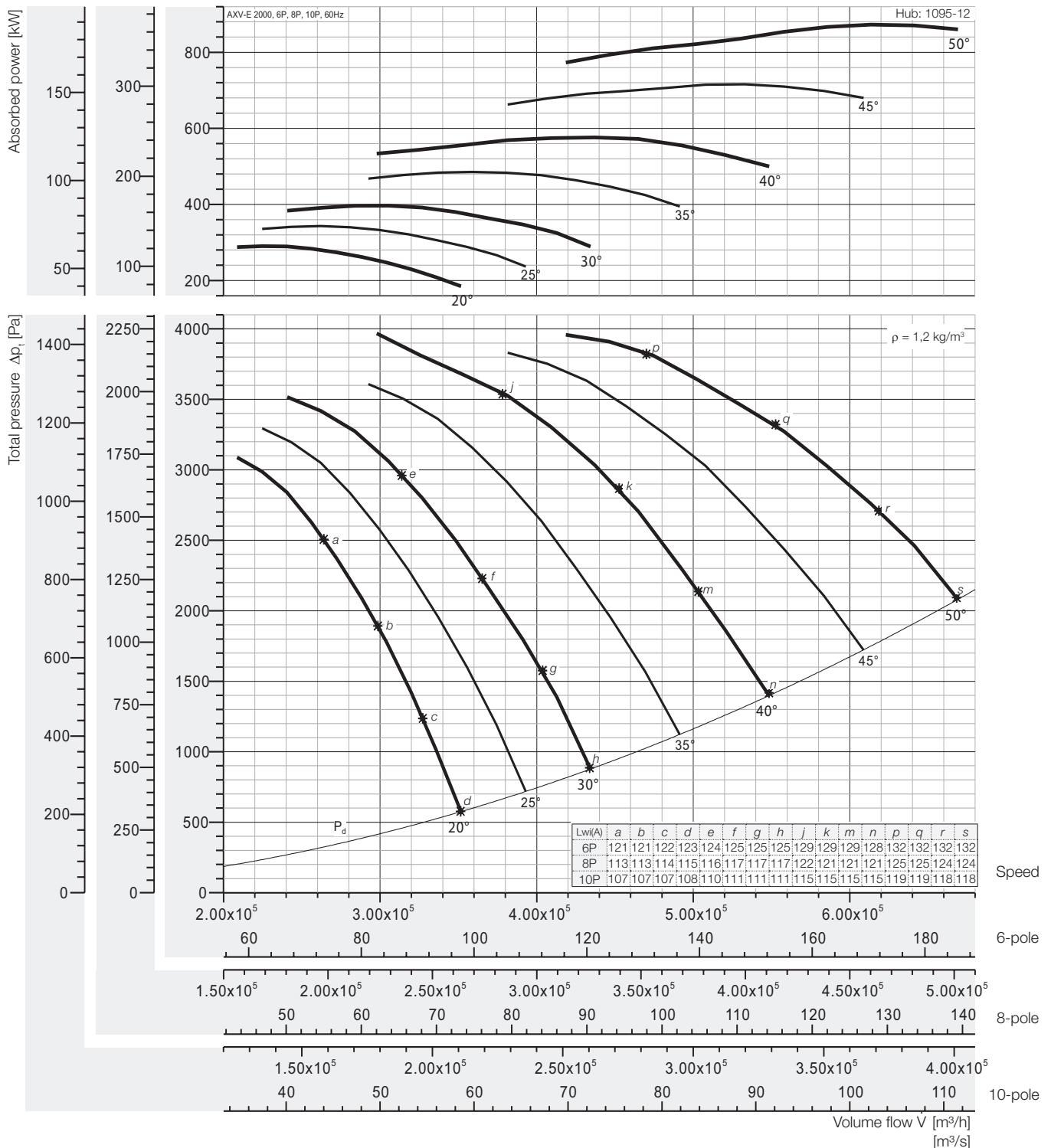

Peak absorbed power [kW]

6-pole = 1200 rpm; 8-pole = 900 rpm; 10-pole = 720 rpm;

N Poles	Pitch angle [°]						
	20	25	30	35	40	45	50
6P motor	290,4	343,0	396,6	485,4	576,2	715,6	872,8
	315	355	400	500	630	-	-
8P motor	122,5	144,7	167,3	204,8	243,1	301,9	368,2
	132	160	200	250	-	315	400
10P motor	62,73	74,10	85,68	104,8	124,5	154,6	188,5
	75	-	90	110	132	160	200

Fan test laboratory AMCA 210/99 Fig.12, Test Chamber. Performance certified is for installation type D - Ducted inlet, Ducted outlet. Performance ratings do not include the effects of appurtenances (accessories-belt cover, pulley & belt). Power rating (kW) does not include transmission losses.

The A-weighted sound ratings shown have been calculated per AMCA International Standard 301. Values shown are for inlet Lw(A) sound power levels for installation Type D: ducted inlet, ducted outlet. Ratings include the effects of duct end correction.



# Performance Curve

AXV-E 2200, 60 Hz

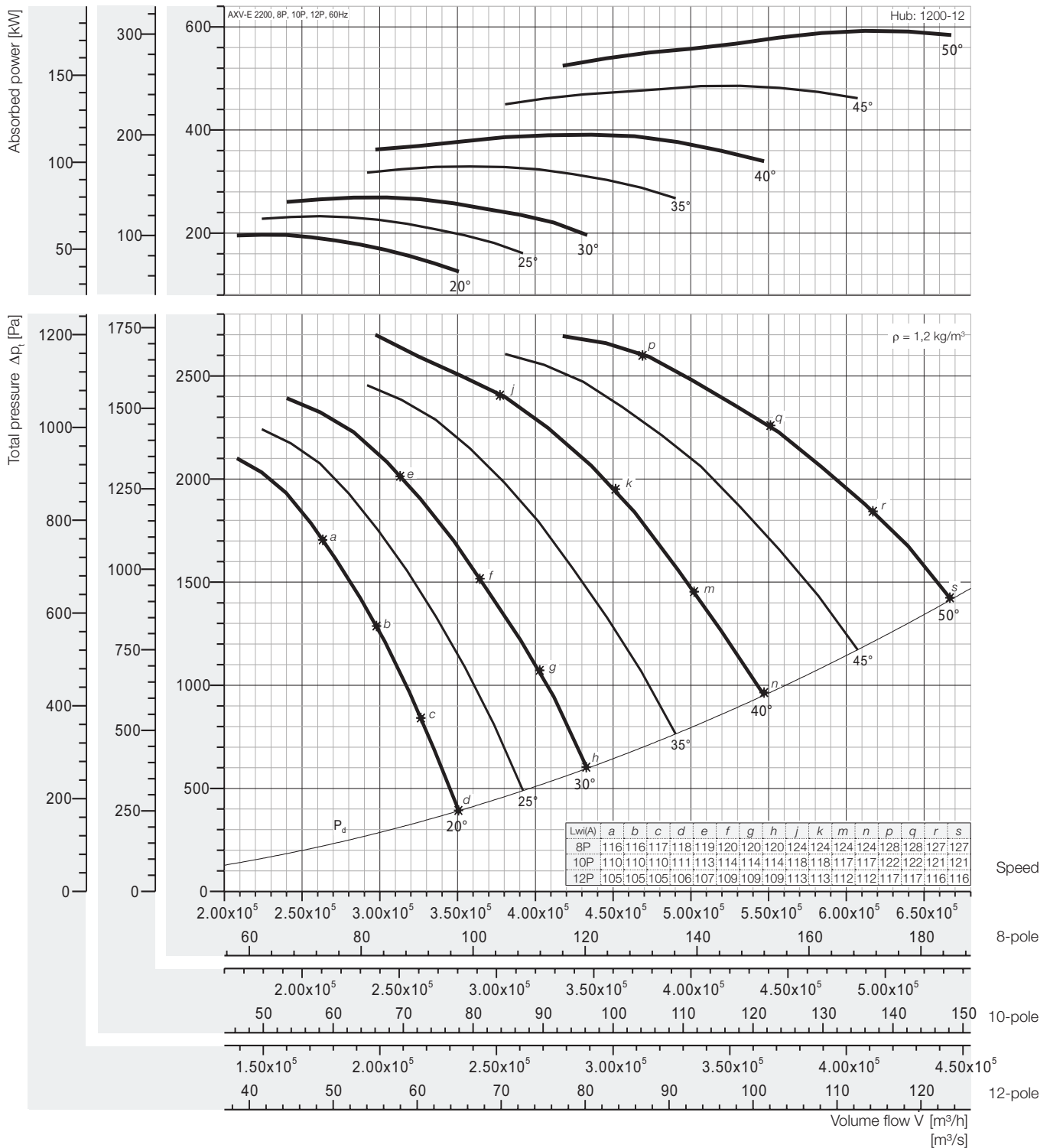

## Peak absorbed power [kW]

8-pole = 900 rpm; 10-pole = 720 rpm; 12-pole = 600 rpm;

N Poles	Pitch angle [°]						
	20	25	30	35	40	45	50
8P motor	197,1	232,8	269,2	329,4	391,1	485,7	592,3
10P motor	100,9	119,2	137,8	168,7	200,0	248,7	303,3
12P motor	58,40	68,98	79,76	97,61	115,9	143,9	175,5

Fan test laboratory AMCA 210/99 Fig.12, Test Chamber. Performance certified is for installation type D - Ducted inlet, Ducted outlet. Performance ratings do not include the effects of appurtenances (accessories-belt cover, pulley & belt). Power rating (kW) does not include transmission losses.

The A-weighted sound ratings shown have been calculated per AMCA International Standard 301. Values shown are for inlet Lw(A) sound power levels for installation Type D: ducted inlet, ducted outlet. Ratings include the effects of duct end correction.

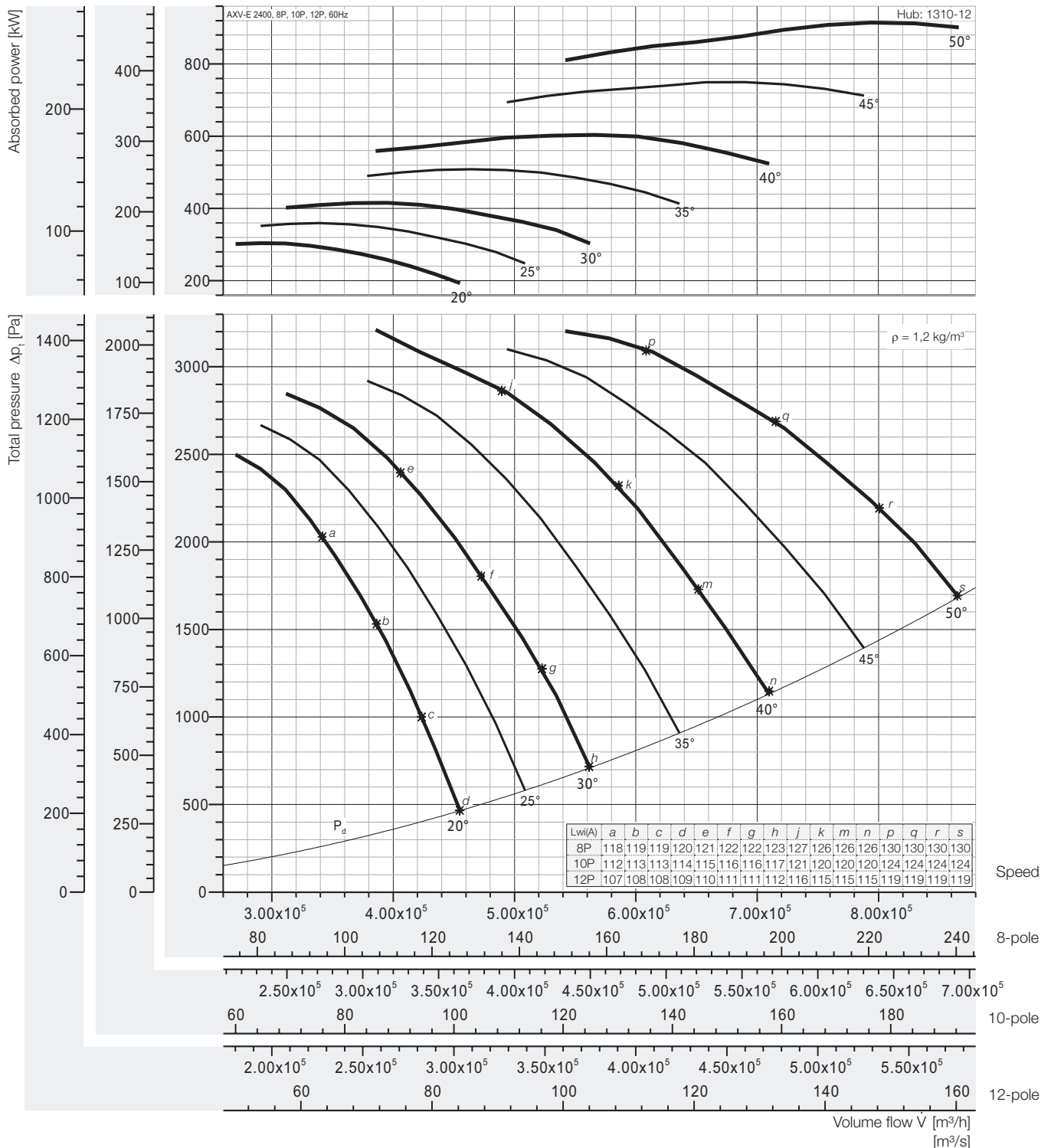

### Peak absorbed power [kW]

8-pole = 900 rpm; 10-pole = 720 rpm; 12-pole = 600 rpm;

N Poles	Pitch angle [°]						
	20	25	30	35	40	45	50
8P motor	304,2	359,4	415,5	508,5	603,6	749,7	914,3
10P motor	155,8	184,0	212,7	260,4	309,1	383,8	468,1
12P motor	90,14	106,5	123,1	150,7	178,9	222,1	270,9

Fan test laboratory AMCA 210/99 Fig.12, Test Chamber. Performance certified is for installation type D - Ducted inlet, Ducted outlet. Performance ratings do not include the effects of appurtenances (accessories-belt cover, pulley & belt). Power rating (kW) does not include transmission losses.

The A-weighted sound ratings shown have been calculated per AMCA International Standard 301. Values shown are for inlet Lw(A) sound power levels for installation Type D: ducted inlet, ducted outlet. Ratings include the effects of duct end correction.





# Performance Curve

AXV-E 2500, 60 Hz

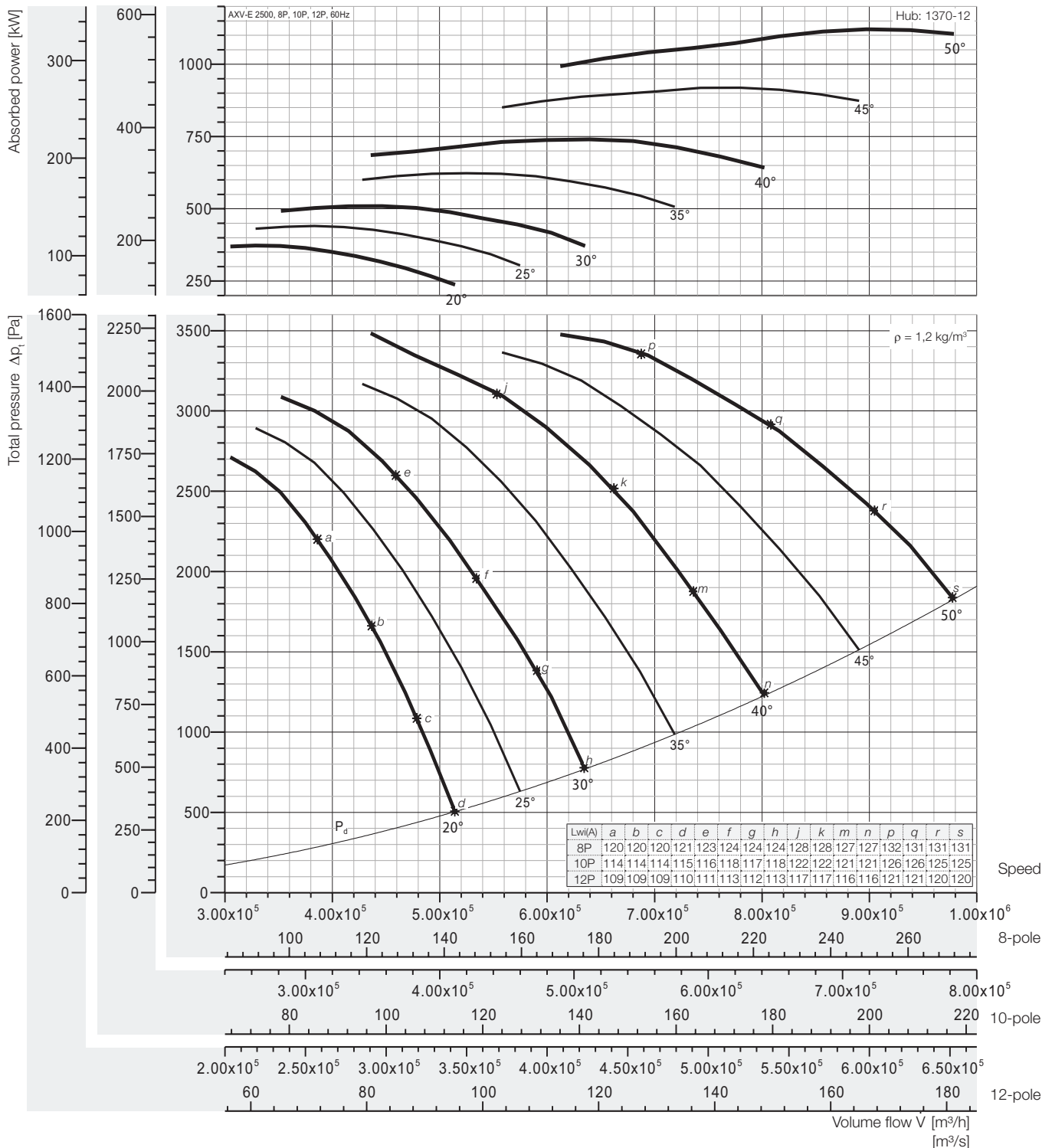

## Peak absorbed power [kW]

8-pole = 900 rpm; 10-pole = 720 rpm; 12-pole = 600 rpm;

N Poles	Pitch angle [°]						
	20	25	30	35	40	45	50
8P motor	372,9	440,6	509,4	623,4	740,0	919,1	1120,9
10P motor	190,9	225,6	260,8	319,2	378,9	470,6	573,9
12P motor	110,0	130,5	150,9	184,7	219,3	272,3	332,1

Fan test laboratory AMCA 210/99 Fig.12, Test Chamber. Performance certified is for installation type D - Ducted inlet, Ducted outlet. Performance ratings do not include the effects of appurtenances (accessories-belt cover, pulley & belt). Power rating (kW) does not include transmission losses.

The A-weighted sound ratings shown have been calculated per AMCA International Standard 301. Values shown are for inlet Lw(A) sound power levels for installation Type D: ducted inlet, ducted outlet. Ratings include the effects of duct end correction.

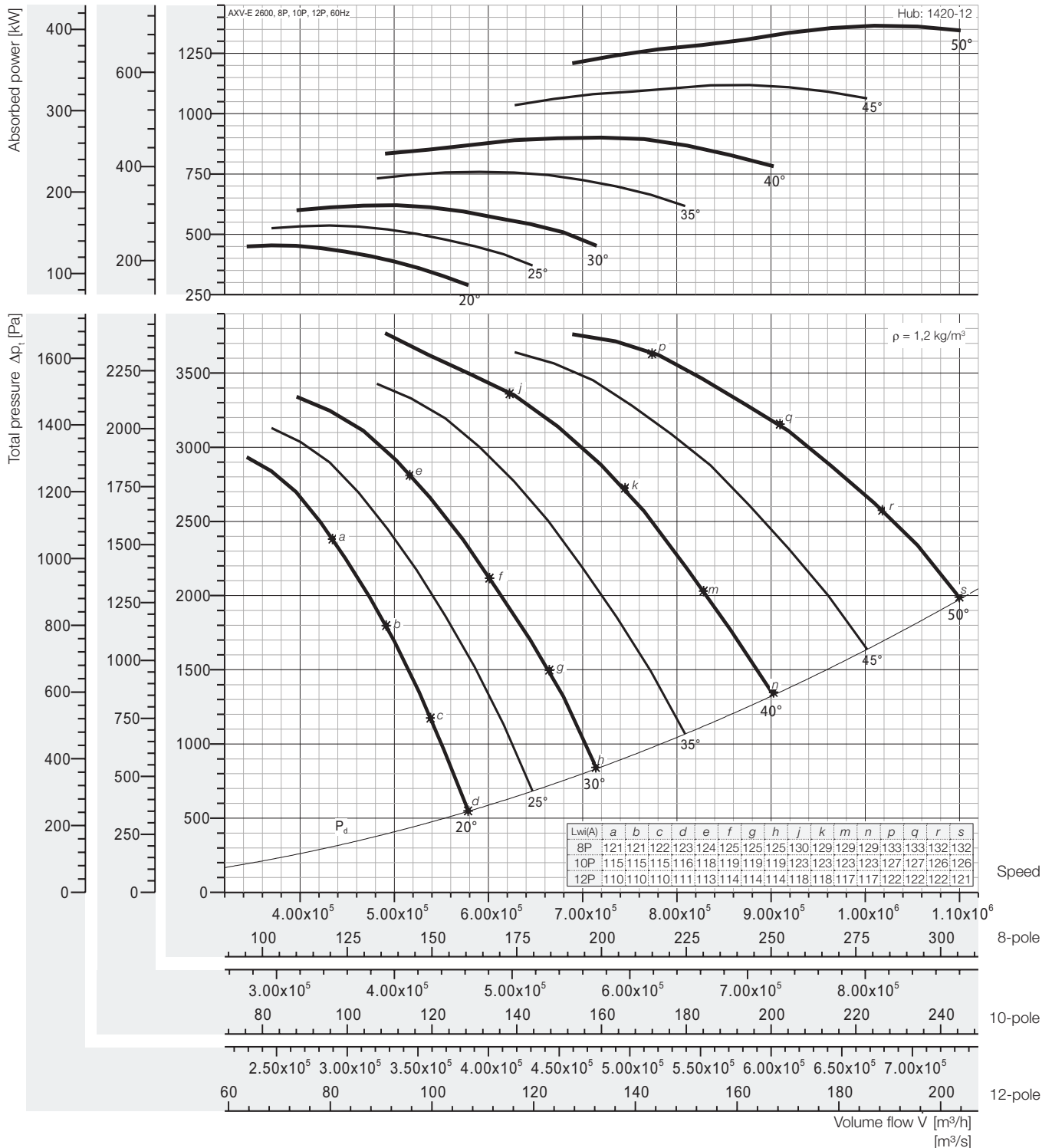

### Peak absorbed power [kW]

8-pole = 900 rpm; 10-pole = 720 rpm; 12-pole = 600 rpm;

N Poles	Pitch angle [°]						
	20	25	30	35	40	45	50
8P motor	454,0	536,3	620,1	758,9	900,8	1119	1365
	500	560	630	-	-	-	-
10P motor	232,5	274,6	317,5	388,6	461,2	572,8	698,6
	250	315	355	400	500	630	710
12P motor	134,5	158,9	183,7	224,9	266,9	331,5	404,3
	160	-	200	250	315	355	450

Fan test laboratory AMCA 210/99 Fig.12, Test Chamber. Performance certified is for installation type D - Ducted inlet, Ducted outlet. Performance ratings do not include the effects of appurtenances (accessories-belt cover, pulley & belt). Power rating (kW) does not include transmission losses.

The A-weighted sound ratings shown have been calculated per AMCA International Standard 301. Values shown are for inlet Lw(A) sound power levels for installation Type D: ducted inlet, ducted outlet. Ratings include the effects of duct end correction.



# Performance Curve

AXV-E 2800, 60 Hz

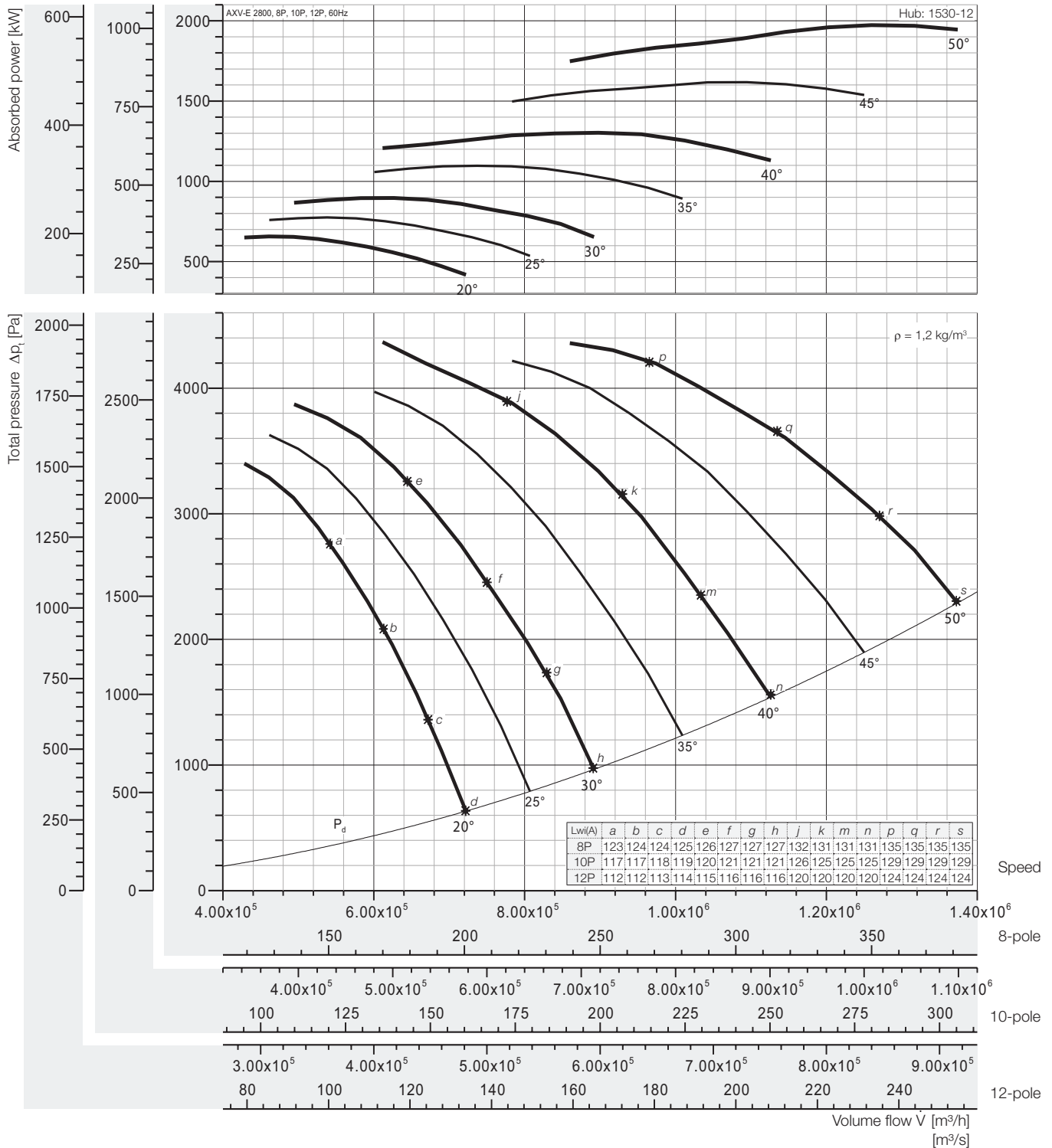

## Peak absorbed power [kW]

8-pole = 900 rpm; 10-pole = 720 rpm; 12-pole = 600 rpm;

N Poles	Pitch angle [°]						
	20	25	30	35	40	45	50
8P motor	656,6 710	775,6 -	896,8 -	1097 -	1302 -	1618 -	1973 -
10P motor	336,2 355	397,1 400	459,1 500	561,9 630	667, 710	828,4 -	1010 -
12P motor	194,5 200	229,8 250	265,7 315	325,2 355	386,0 400	479,4 500	584,7 630

Fan test laboratory AMCA 210/99 Fig.12, Test Chamber. Performance certified is for installation type D - Ducted inlet, Ducted outlet. Performance ratings do not include the effects of appurtenances (accessories-belt cover, pulley & belt). Power rating (kW) does not include transmission losses.

The A-weighted sound ratings shown have been calculated per AMCA International Standard 301. Values shown are for inlet Lw(A) sound power levels for installation Type D: ducted inlet, ducted outlet. Ratings include the effects of duct end correction.

# Vane Axial Flow Fans

## Dimensions



### Direct Driven

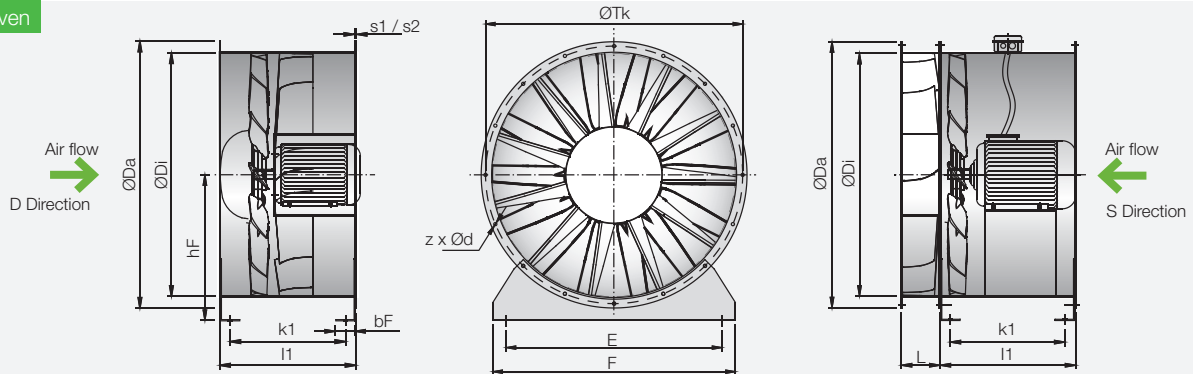

### Belt Driven

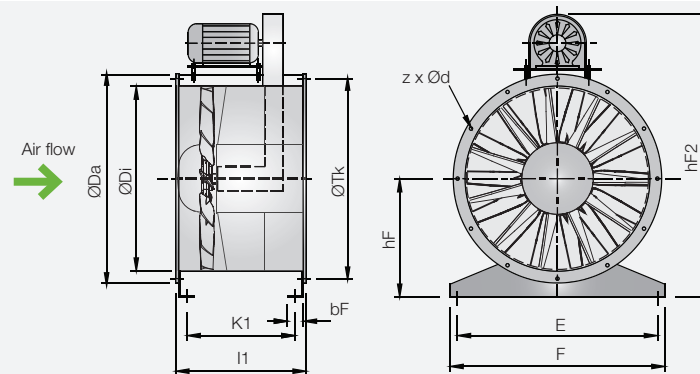

Model size	Da [mm]	Di [mm]	hF [mm]	hF2 [mm]	z x d [mm]	Tk [mm]	E [mm]	F [mm]	L [mm]	bF [mm]
800	904	797	500	1544	12* x 14	861	730	800	190	80
900	1004	894	580	1746	12* x 14	958	830	900	200	80
1000	1105	1003	630	1821	12* x 14	1067	930	990	200	80
1120	1245	1125	690	1990	16* x 18	1200	1050	1110	240	100
1250	1370	1250	750	2175	16* x 18	1337	1180	1240	240	100
1400	1525	1405	830	2362	16* x 18	1475	1330	1390	260	100
1600	1725	1605	930	2550	20* x 18	1675	1530	1590	260	100

Model size	LH/1							
	s1 [mm]	k1 [mm]	l1 [mm]	motor max.	s2 [mm]	k1 [mm]	l1 [mm]	motor max.
800	2,5	316	401	180	2	316	401	160
900	3	429	515	200	2	429	515	180
1000	3	429	515	225	2	429	515	200
1120	4	522	630	225	2	522	630	200
1250	4	522	630	250	3	522	630	225

Model size	LH/2							
	s1 [mm]	k1 [mm]	l1 [mm]	motor max.	s2 [mm]	k1 [mm]	l1 [mm]	motor max.
800	3	614	700	200	2	614	700	180
900	4	612	700	225	2	612	700	200
1000	4	692	780	250	2	692	780	225
1120	4	892	1000	250	2	892	1000	225
1250	4	892	1000	280	3	892	1000	250
1400	4	892	1000	315	3	892	1000	280
1600	4	892	1000	315	3	892	1000	280

We reserve the right to alter measurements without notice in case of technical improvements.

# Vane Axial Flow Fans

## Dimensions

AXV-E

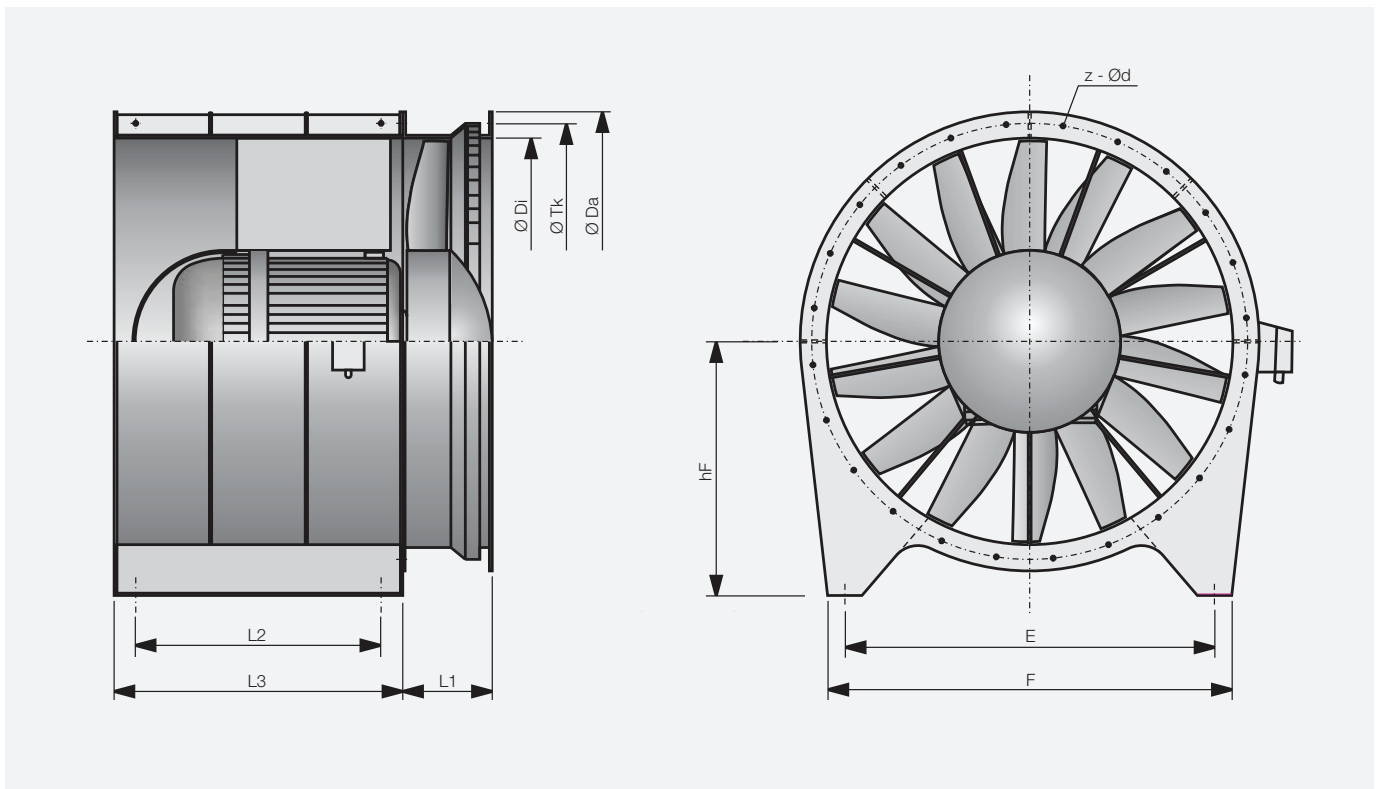
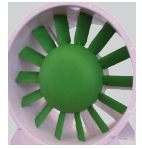

Model size	Da [mm]	Di [mm]	hF [mm]	z x d [mm]	Tk [mm]	E [mm]	F [mm]	L1 [mm]	L2 [mm]	L3 [mm]
1800	2010	1805	1120	24x18	1920	1660	1800	400	1200	1400
2000	2210	2005	1165	32x18	2120	1820	2000	445	1300	1500
2200	2440	2205	1265	32x18	2340	2020	2200	490	1400	1650
2400	2630	2405	1370	32x18	2530	2220	2400	550	1500	1800
2500	2740	2505	1420	36x24	2640	2320	2500	555	1530	1820
2600	2840	2605	1470	36x24	2740	2380	2600	590	1580	1850
2800	3150	2805	1570	36x24	3000	2500	2800	1300	1680	1900

We reserve the right to alter measurements without notice in case of technical improvements.

### ED

Bellmouth inlet

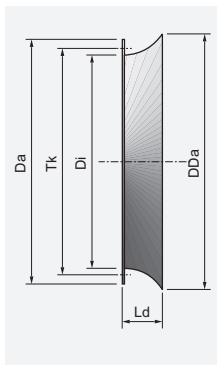

### GL-AXV

Matching flange

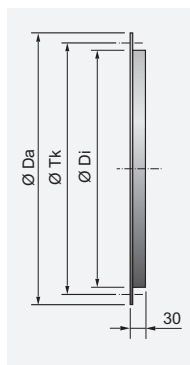

### EV-AXV

Flexible connector compl.

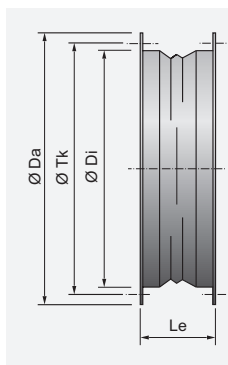

### LRK

Air-operated damper

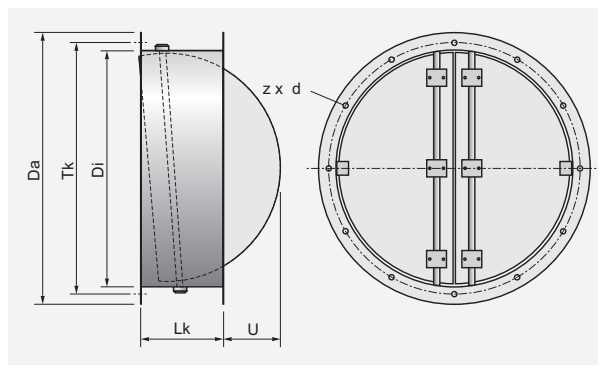

Model size	Da [mm]	Di [mm]	Tk [mm]	z x d [mm]	DDa [mm]	Ld [mm]	Lk [mm]	Le [mm]	U [mm]
800	904	797	861	12* x 14	915	250	350	130	110
900	1004	894	958	12* x 14	1015	250	350	130	170
1000	1105	1003	1067	12* x 14	1115	250	350	130	225
1120	1245	1125	1200	16* x 18	1243	250	350	130	255
1250	1370	1250	1337	16* x 18	1364	250	400	170	375
1400	1525	1405	1475	16* x 18	1523	250	400	170	450
1600	1725	1605	1675	20* x 18	1723	250	400	170	550

# Vane Axial Flow Fans

## Sound Information

### Sound power levels

This term refers to the power which a source radiates as sound. Sound power levels are expressed in decibels with a reference level of 1 picoWatt. The sound power level of a source remains the same regardless of its environment and the distance to the listener.

If the sound power frequency spectrum is needed, for as follows: example, the design of sound attenuators, the A-weighted rated sound power levels at particular octave band frequency  $L_{WA}$  can be calculated by subtracting the relative sound  $L_{wrel}$ :

$$L_{WA} = L_{wi} + L_{wrel}$$

### Sound pressure level

These are pressure fluctuations generated by a source expressed in decibels with a reference level of 20  $\mu$ Pa. The sound pressure level varies with the distance of a sound source to the listener and its environment.

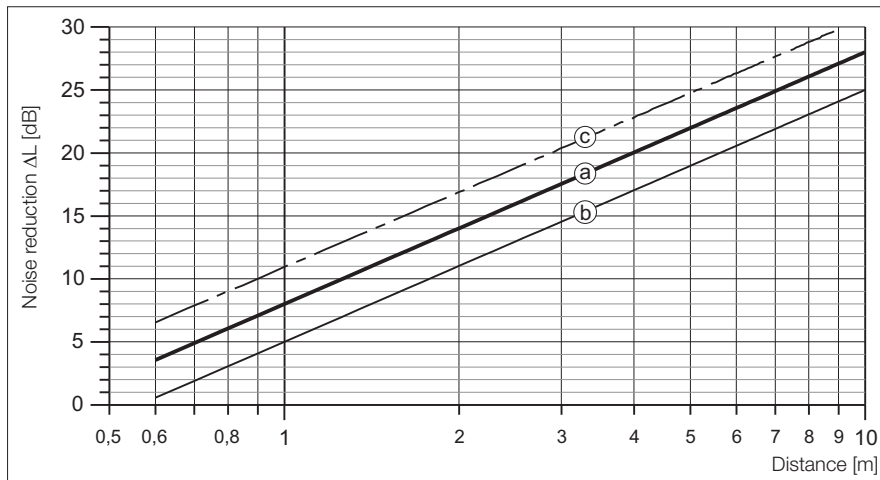

Sound level reduction half sphere

- a: without reflexion
- b: with reflexion
- c: full sphere without reflexion

### Frequencies

Sound is split into different frequencies. Frequencies of human hearing range from about 20 cycles per second (Hz) to 20.000 cycles per second (Hz). For practical purposes, WOLTER publishes noise data in eight octave bands with the centre frequencies of (63,) 125, 250, 500, 1000, 2000, 4000 and 8000 Hz.

Each fan has its own specific correction factor which is to be deducted from sound power according to the octave band.

### A-weighted sound pressure level in dB (A)

The human ear is more sensitive to sound in some frequencies than in others. The A-weighting is an attempt to reflect this natural perception of sound. The A-weighting is a set of figures which are applied to the sound pressure levels. The levels in each of the octave bands are added logarithmically to give a single figure. The A-weighting over the octave band is as follows:

Table 1)

Frequency [Hz]	63	125	250	500	1000	2000	4000	8000
A-weighting [dB]	-25,5	-15,5	-8,5	-3	0	+1	+1	-1

Table 2)  
Addition of sound levels

Difference between two sound levels [dB]	Add to the higher level [dB]
0 - 1	3
2 - 3	2
4 - 9	1
$\geq 10$	0

$$L_{\Sigma} = 10 \cdot \lg(10^{0,1 \cdot L_1} + 10^{0,1 \cdot L_2} + \dots + 10^{0,1 \cdot L_n})$$

where:

$L_1$  = sound level of a source 1

$L_{\Sigma}$  = resulting summation sound level

### Summation of several congeneric sound levels

$$L_{\Sigma} = L_1 + 10 \cdot \lg(z)$$

where:

$z$  = number of sources

$L_1$  = sound level of a single source

$L_{\Sigma}$  = resulting summation sound level

Relative Sound Power Frequency Spectrum ( $L_{wrel}$ ) [dB]

Fan Model	Poles	63	125	250	500	1000	2000	4000	8000
Size	[-]	[Hz]	[Hz]	[Hz]	[Hz]	[Hz]	[Hz]	[Hz]	[Hz]
800	4	-8	-3	-8	-10	-13	-16	-22	-28
	6	-5	-7	-8	-10	-13	-18	-24	-28
	8	-4	-7	-7	-10	-13	-19	-24	-27
900	4	-10	-4	-6	-10	-14	-16	-22	-28
	6	-6	-4	-7	-11	-14	-17	-24	-27
	8	-5	-5	-7	-11	-13	-19	-25	-26
1000	4	-11	-4	-6	-10	-13	-16	-22	-28
	6	-7	-4	-7	-10	-13	-17	-24	-29
	8	-5	-5	-8	-10	-13	-19	-25	-30
1120	4	-10	-4	-6	-10	-13	-16	-22	-28
	6	-7	-4	-7	-10	-13	-18	-24	-29
	8	-5	-5	-8	-11	-14	-19	-26	-30
1250	4	-10	-4	-6	-10	-13	-16	-22	-28
	6	-7	-4	-7	-11	-14	-18	-25	-30
	8	-5	-5	-8	-11	-14	-20	-26	-30
1400	6	-6	-4	-7	-11	-14	-18	-25	-30
	8	-4	-5	-8	-11	-14	-20	-26	-31
	10	-4	-5	-8	-11	-15	-21	-27	-31
1600	6	-6	-4	-8	-11	-14	-19	-25	-30
	8	-4	-5	-9	-12	-15	-20	-27	-31
	10	-4	-5	-9	-11	-15	-21	-27	-31
1800	6	-6	-4	-8	-11	-14	-19	-25	-31
	8	-4	-5	-9	-12	-15	-21	-27	-31
	10	-4	-5	-9	-12	-16	-22	-28	-31
2000	6	-5	-4	-8	-12	-15	-19	-26	-31
	8	-4	-5	-9	-12	-15	-21	-27	-32
	10	-3	-6	-9	-12	-16	-22	-28	-32
2200	8	-3	-5	-9	-12	-16	-21	-28	-32
	10	-3	-6	-9	-12	-16	-22	-28	-32
	12	-3	-6	-9	-12	-17	-23	-28	-32
2400	8	-3	-5	-10	-13	-16	-21	-28	-32
	10	-3	-6	-10	-12	-16	-22	-28	-32
	12	-3	-6	-9	-12	-17	-23	-28	-32
2500	8	-3	-6	-10	-13	-16	-21	-28	-32
	10	-3	-6	-10	-12	-16	-23	-28	-32
	12	-3	-6	-9	-12	-17	-23	-28	-32
2600	8	-3	-6	-10	-13	-16	-22	-28	-32
	10	-3	-6	-10	-12	-16	-23	-28	-32
	12	-3	-6	-10	-12	-17	-23	-29	-32
2800	8	-4	-5	-9	-12	-15	-20	-27	-32
	10	-3	-6	-10	-13	-16	-22	-28	-32
	12	-3	-6	-10	-13	-17	-23	-29	-32

• Sound power frequency spectrum calculated with this  $L_{wrel}$  are not licensed by AMCA International.



# Tubular Sound Attenuator for AXV-E

SA, SPA

## SPA 800 -1D

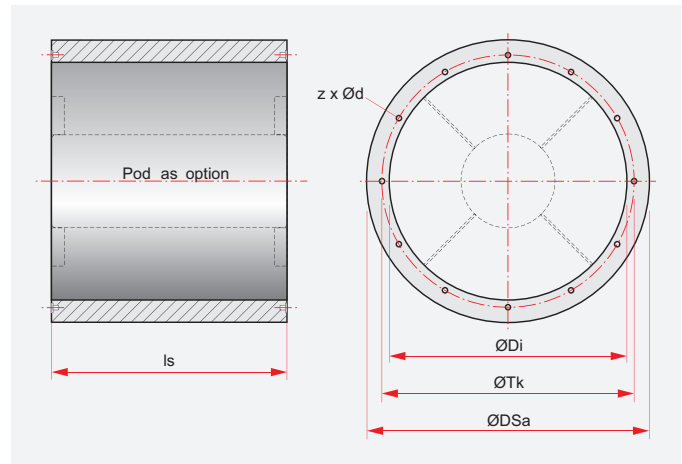
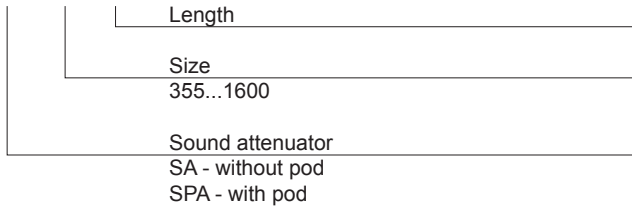

Attenuators made of galvanised sheet steel. Connecting flanges correspond to those of the AXV axial fan series.

Size	DSa	Tk	Di	ls		■				Length	Type	Pitch angle	Octave band mid-frequency [Hz]												
				x 1D	x 2D	SA-1D	SPA-1D	SA-2D	SPA-2D				63	125	250	500	1k	2k	4k	8k					
	[mm]	[mm]	[mm]	[mm]	[mm]	[kg]	[kg]	[kg]	[kg]			setting													
355 400 450	459	405	359	355	710	12	18	16	23	1D	SA-1D	all	2	4	6	10	14	10	7	8					
	601	448	401	400	800	14	23	19	29			low	4	6	8	13	20	21	18	16					
	650	497	450	450	900	18	29	23	36			med	4	6	8	12	18	19	18	14					
												high	4	6	8	11	13	16	16	11					
500 560 630 710 800	704	551	504	500	1000	22	36	28	43	1D	SA-1D	all	3	4	8	14	14	9	8	7					
	629	565	560	1120	25	41	31	50	low			4	6	9	17	26	21	18	12						
	698	634	630	1260	29	47	37	59	med			4	6	9	17	23	20	18	11						
	775	711	710	1420	37	60	47	75	high			4	6	9	16	17	16	14	11						
900 1000 1120 1250	997	861	797	800	1600	69	108	90	141	2D	SA-2D	low	6	8	14	23	24	15	13	10					
	1094	1067	1003	1000	2000	125	190	156	234			med	6	8	13	22	22	14	13	9					
												high	6	8	12	20	18	13	11	9					
												1200	1125	1120	2240	132	210	169	260	low	8	11	16	30	39
med	8	11	16	27	32	32	29	19																	
high	8	11	16	24	23	23	24	17																	
1400 1600	1605	1475	1405	1400	2800	197	316	250	397	1D	SA-1D	all	4	5	10	14	11	7	6	6					
	1805	1675	1605	1600	3200	275	540	348	682			low	5	7	12	21	20	14	12	9					
	1475	1405	1400	2800	197	316	250	397	med.			5	7	12	19	18	13	11	9						
									high			5	7	12	15	16	12	10	8						
1400 1600	1605	1475	1405	1400	2800	197	316	250	397	2D	SA-2D	low	8	9	15	20	19	12	11	9					
												med.	8	9	14	20	17	11	10	9					
												high	8	9	13	19	14	10	9	9					
												1805	1675	1605	3200	275	540	348	682	low	10	14	22	28	31
med.	10	14	22	25	27	25	16	15																	
high	10	14	22	21	21	21	15	14																	

• Low, Medium and High Pitch Angle setting correspond to 10°, 22° and 35° pitch angle approximately: for other pitch angles use interpolation.

• Sizes 1800 - 2800 TBA.

Pressure Loss SPA - 1D

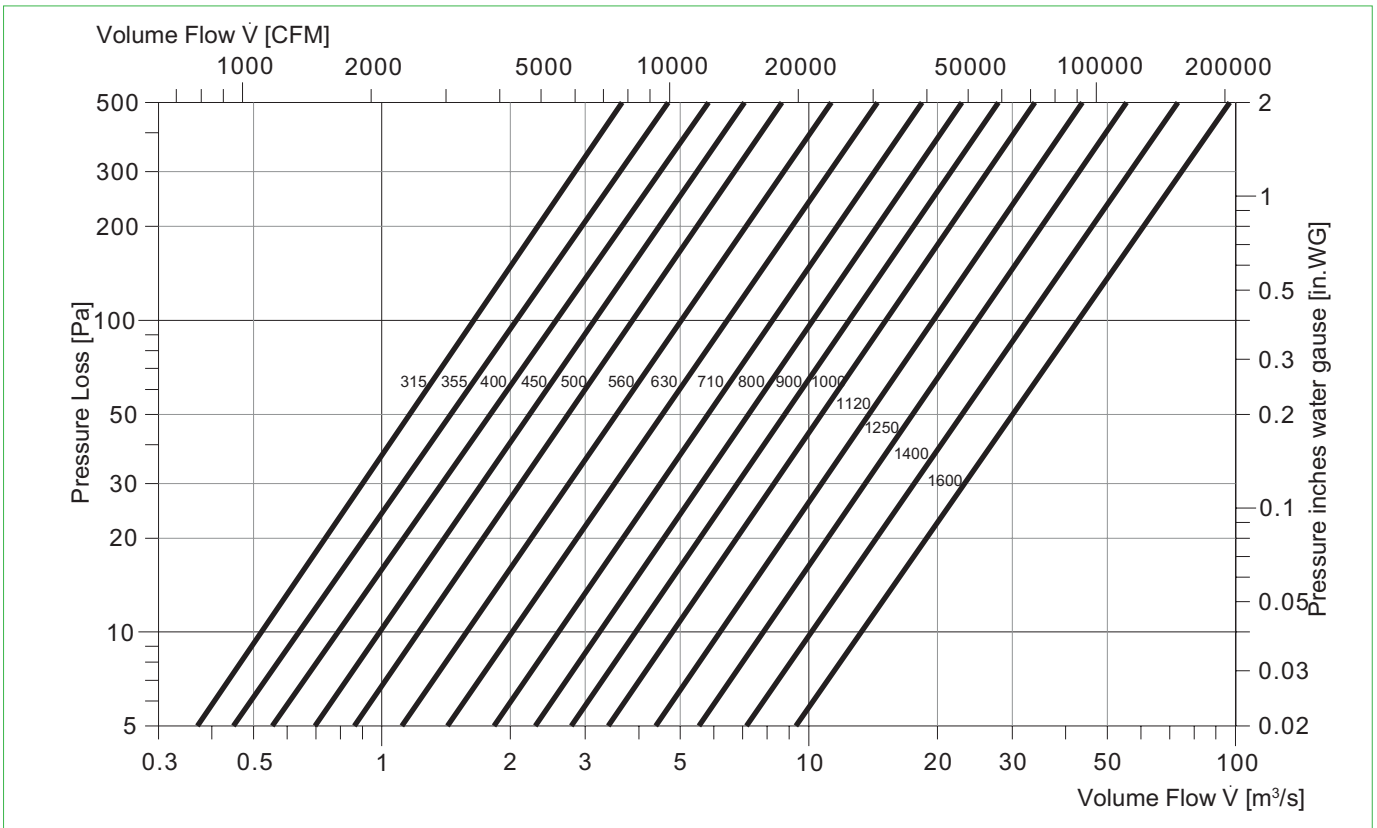

Pressure Loss SPA - 2D

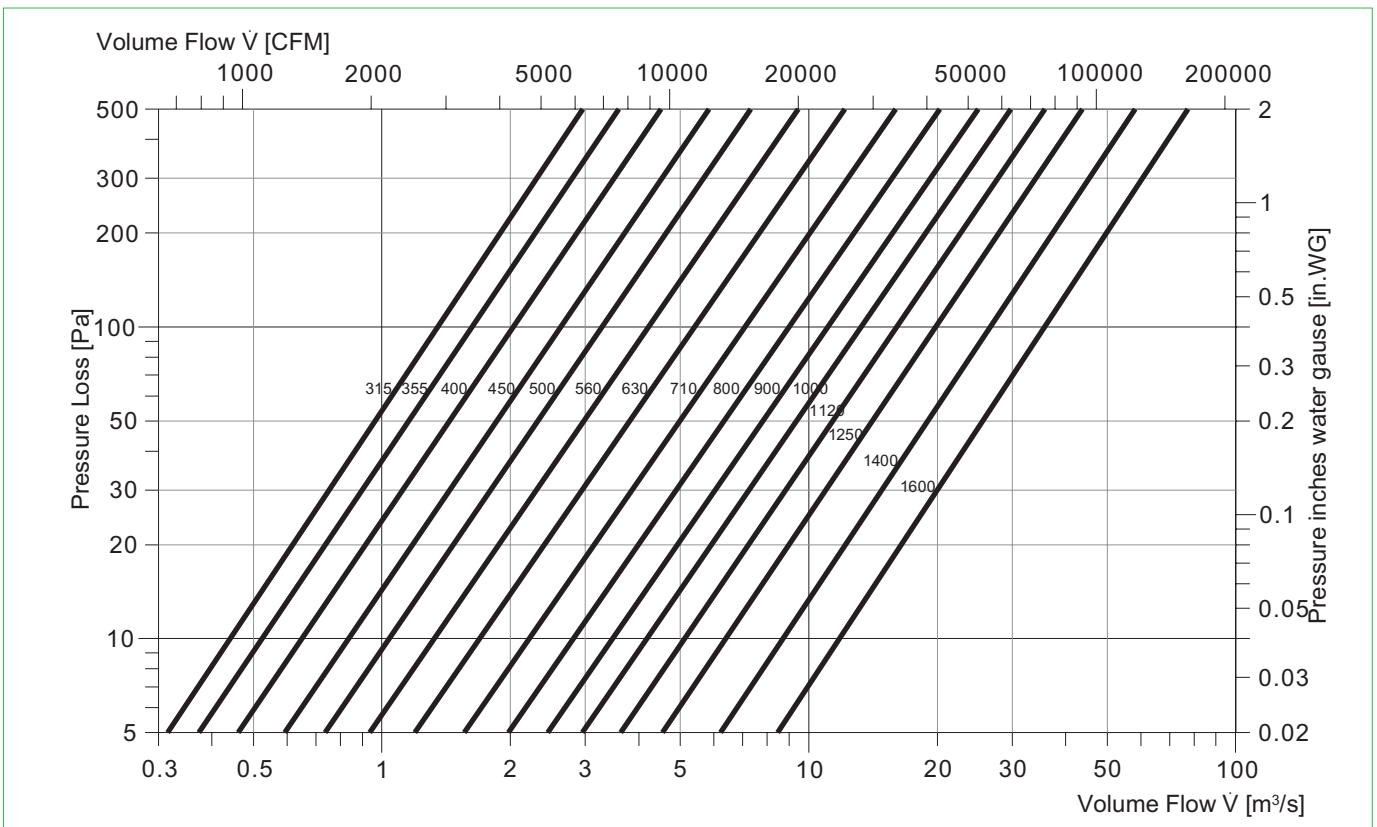

• Performance of sound attenuator are not licensed by AMCA International.

# Wolter Sales Network

## Inland

Ing. Günther Rößler  
D-07619 Schkölen  
Tel. (+49) 03 66 94 / 22 359  
Fax (+49) 03 66 94 / 22 357  
guenther.roessler@wolterfans.de

Mattias Industrievertretungen  
D-16259 Bad Freienwalde  
Tel. (+49)03344/301994  
Fax (+49)03344/301996  
thomas.mattias@wolterfans.de

Industrieservice Drexler  
D-49080 Osnabrück  
Tel. (+49) 0 541 / 20 04 88 3  
Fax (+49) 0 541 / 20 04 88 4  
wolfgang.drexler@wolterfans.de

Burkhardt Projekt GmbH  
D-67583 Guntersblum  
Tel. (+49) 0 62 49 / 82 01  
Fax (+49) 0 62 49 / 88 58  
info@bp-wolter.de

Friedrich Glock  
D-97980 Bad Mergentheim  
Tel. (+49) 0 79 31 / 37 44  
Fax (+49) 0 79 31 / 28 58  
friedrich.glock@wolterfans.de

## Europe

### Danmark:

Air-Con Danmark A/S  
DK-8400 Ebeltoft  
Tel. (+45)086/345111  
Fax (+45)086/345810  
jbj@air-con.dk

### Hungary:

Air-Technik Légtechnikai Kft.  
HU-2040 Budaörs  
Tel. (+36)023/428533  
Fax (+36)023/428544  
bp.air-technik@troges.hu

### Ireland:

Finheat Ltd.  
IE-Dublin 12, Walkinstown  
Tel. (+353)01/4564066  
Fax (+353)01/4564071  
sales@finheat.com

### Lithuania:

JSC Saldos Prekyba  
LT-78109 Siauliai  
Tel. (+37)041/540212  
Fax (+37)041/596176  
prekyba@saldai.lt

### Netherlands:

AirFan B. V.  
NL-7442 CX Nijverdal  
Tel. (+31)054/8366366  
Fax (+31)054/8365320  
ventilatie@airfan.nl

Rucon B. V. Ventilatoren  
NL-3840 AG Harderwijk  
Tel. (+31)034/1411670  
Fax (+31)034/1411690  
verkoop@rucon.nl

### Österreich:

Wolter Werksvertretung Österreich  
A-4040 Linz  
Tel. (+43) 07 32 / 75 77 07  
Fax (+43)07 32 / 75 77 07 75  
wolter.linz@aon.at

## Poland:

Wentoprodukt  
44-100 Gliwice  
Tel. (+48)32 331-34-24  
Fax (+48)32 729-76-53  
biuro@wentoprodukt.pl

## Portugal:

Safe Park Ventilação Industrial Lda.  
P-2675-240 Odivelas  
Tel. (+351) 21 93 / 75 265  
Fax (+351) 21 93 / 86 061  
safepark@netcabo.pt

## Russia:

Euroclimat-Prof  
RU-107082 Moskau  
Tel. (+7) 4 95 / 97 57 530  
Fax (+7) 4 95 / 97 57 530  
gso@euroclimat.ru

## Schweiz:

Anson AG Zürich  
CH-8055 Zürich  
Tel. (+41) 0 44 / 46 11 111  
Fax (+41) 0 44 / 46 13 111  
info@anson.ch

Ventra Technik AG  
CH-8599 Salmsach  
Tel. (+41) 0 71 / 46 11 447  
Fax (+41) 0 71 / 46 11 448  
ventra@bluwin.ch

## Turkey:

Air Trade Centre Ltd Sti Türkiye,  
TR-34418 Seyrantepe / Istanbul  
Tel. (+90) 02 12 / 28 34 510  
Fax (+90) 02 12 / 27 83 964  
atc.turkey@airtradecentre.com

## United Kingdom:

Wolter UK Ltd.  
GB-B37 7UQ Solihull  
Tel. (+44) 01 21 / 63 55 390  
Fax (+44) 01 21 / 63 55 391  
info@wolteruk.com

## Middle East and North Africa

### Egypt:

Tiba Engineering Industries Co.  
Nasr City, Cairo  
Tel. (+2) 02 / 40 22 866  
Fax (+2) 02 / 40 44 771  
tibaengineering@manz-group.com

### Israel:

Lea Ventilation Industries Ltd.  
IL-27113 Kiriyat-Bialik, Israel  
Tel. (+972) 0 48 / 76 23 57  
Fax (+972) 0 48 / 76 20 51  
mail@lea.co.il

### United Arab Emirates, Kuwait,

### Lebanon:

Wolter Ventilation LLC  
Energy International  
P.O. Box 3562 Sharjah, UAE  
Tel. (+971) 06 / 53 43 477  
Fax (+971) 06 / 53 43 756  
energysh@emirates.net.ae

## Asia

### China Mainland:

Taizhou Wolter Ventilation Co. Ltd.  
Hengjie, Luqiao District  
Taizhou City, Zhejiang  
Tel. (+86) 576 / 26 22 666 (26 52 888)  
Fax (+86) 576 / 26 56 830

## Hongkong:

Wolter Asia Ltd.  
Hong Kong  
Tel. (+852) 0 24 / 56 01 98  
Fax (+852) 0 24 / 56 02 90  
info@wolter.com.hk

## India:

Wolter Ventilators India Pvt. Ltd.  
867 D, Block-A, Sushant Lok, Phase-I,  
Gurgaon - 122009 (Haryana)  
Tel. +91 124 2577797, 4261001-3  
sales@wolterindia.in

## Indonesia:

PT. Agung Kipas Kastara.  
ID-14440 Jakarta Indonesia  
Tel. +62 (0) 21 / 6667 6925, 6667 6926  
Fax +62 (0) 21 / 6667 6927  
indowolter@cbn.net.id

## Korea:

Kaceco-Wolter  
14-1, Dang-dong, Gunpo-shi, Gyeonggi-do  
Tel. +82 (0) 31 / 4773 104  
Fax +82 (0) 31 / 4773 132  
wolter@kaceco.com / info@kaceco.com

## Malaysia:

Vibrantech (M) Sdn Bhd.  
47200 Petaling Jaya Selangor, Malaysia  
Tel. +603 (0) 7847 3500  
Fax +603 (0) 7847 3380  
sales@vibrantech-sb.com

## Singapore:

Wolter Pte. Ltd.  
SG-569738 Singapore  
Tel. (+65) 0 63 / 52 95 48  
Fax (+65) 0 63 / 52 95 47  
info@wolterfans.com.sg

## Sri Lanka:

Sirocco Air Technologies (Pvt) Ltd.  
28/12, Gemunu Mawatha, Kotuwegoda,  
Rajagiriya, Sri Lanka  
Tel. +94 11 7 392 010  
Fax +94 11 7 392 015  
suren@sairt.com

## Taiwan:

Waxlink International Co., Ltd.  
8F No. 218 Roosevelt Rd., Sec. 6  
Taipei, Taiwan  
Tel. (+886) 02 / 89 32 11 96  
Fax (+886) 02 / 89 32 11 97  
waxlink.tech@msa.hinet.net

## Thailand:

Wolter Ventilation Co., Ltd.  
Thamai Kratumban Samutsakorn 74110  
Thailand  
Tel. +66 (0) 3486 6555  
Fax +66 (0) 3486 6599  
natiphan@wolterfan.com

## Australia

The Sydney Fan Company.  
NSW 2147, Sydney, Australia  
Tel. +61 (0) 2 / 9624 4000  
Fax +61 (0) 2 / 9624 4100  
sales@thesydneyfancompany.com

## Wolter GmbH

### Maschinen-und Apparatebau KG

Am Wasen 11  
D-76316 Malsch / Germany  
Tel. +49 (0) 7204/9201-0  
Fax +49 (0) 7204/9201-11  
www.wolter.eu  
info@wolter.eu





Reference: A09-E, V2019/June, Printed in June, 2019