

EXTRUDED ALUMINUM, 6" DEEP, FIXED DRAINABLE TYPE BLADE

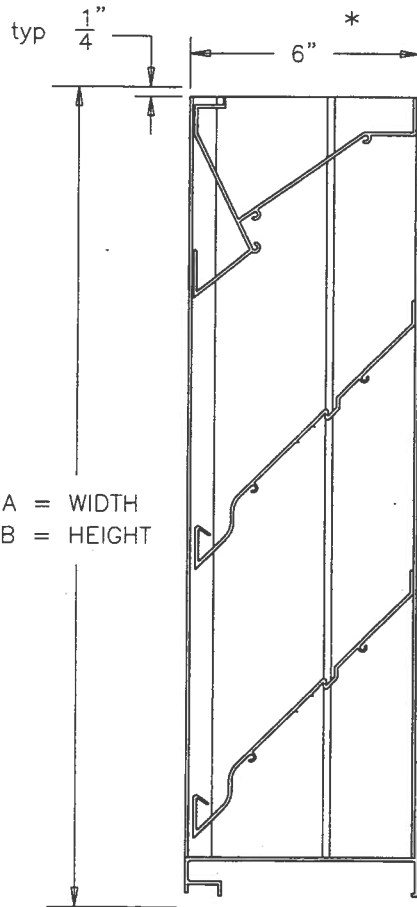

SECTION VIEW

A = WIDTH
B = HEIGHT

- MODEL X6D4
STANDARD SPECIFICATIONS**
- FRAME: 6" DEEP CHANNEL, .081" THICK 6063-T5 EXTRUDED ALUMINUM ALLOY.
 - BLADES: .081" THICK 6063-T5 EXTRUDED ALUMINUM ALLOY.
 - FINISH: MILL.
 - SCREEN: 1/2" REMOVABLE EXPANDED ALUMINUM BIRD SCREEN LOCATED ON INTERIOR.

MAXIMUM PANEL SIZE: 96" X 96".

MINIMUM PANEL SIZE: 12" X 12".

DIMENSIONS: "A" (WIDTH) AND "B" (HEIGHT) ARE OPENING SIZES. LOUVERS ARE MADE 1/2" UNDERSIZE.

* PANELS OVER 48" WIDE WILL BE 7-1/2" DEEP DUE TO A VERTICAL INTERIOR BLADE SUPPORT ANGLE.

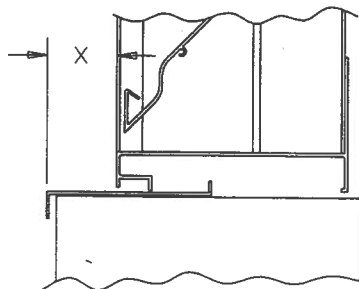

EXTENDED SILL
OPTIONAL

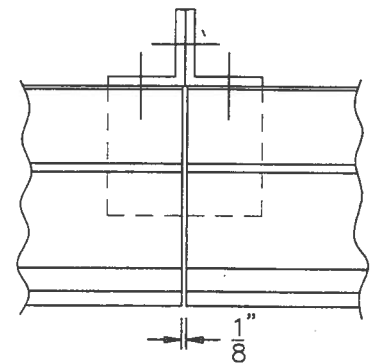

ARCHITECTURAL VERTICAL
MULLION OPTIONAL

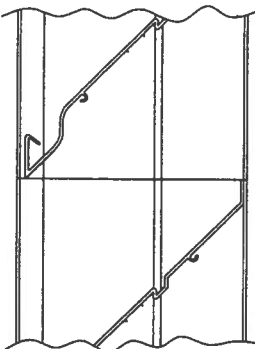

STANDARD HORIZONTAL
MULLION

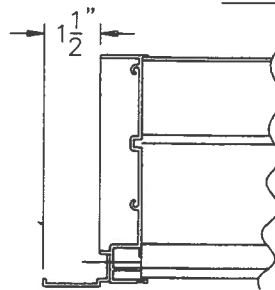

FLANGED FRAME
OPTIONAL
(JAMB SHOWN)

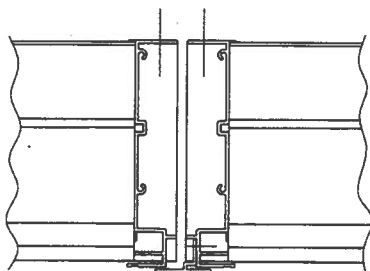

STANDARD VERTICAL
MULLION



CESCO certifies that the model X6D4 louver shown herein is licensed to bear the AMCA Seal. The ratings shown are based on tests and procedures performed in accordance with AMCA Publication 511 and comply with the requirements of the AMCA Certified Ratings Program. The AMCA Certified Ratings Seal applies to air performance ratings and water penetration ratings.



A MESTEK COMPANY

9300 73rd AVE NORTH
Phone (888) 422-3726

MINNEAPOLIS, MN
Fax (800) 241-9344

X6D4 STATIONARY LOUVER

DRN. BY ESS	DWG. NO. X6D4.	REV.
DATE 12-29-00		

Water Penetration : .01 oz. (3.0 g.) at 1029 fpm (5.22 m/s) recommended free area velocity
Pressure Drop : .17 in. wg. (42.2 Pa.) at 1029 fpm (5.22 m/s) and 8232 SCFM (3.88 scm/s)
Free Area : 8.0 sq.ft. (0.743 sq. m.) = 50.% for 48" x 48" (1.22 m x 1.22 m) test size

PRESSURE DROP

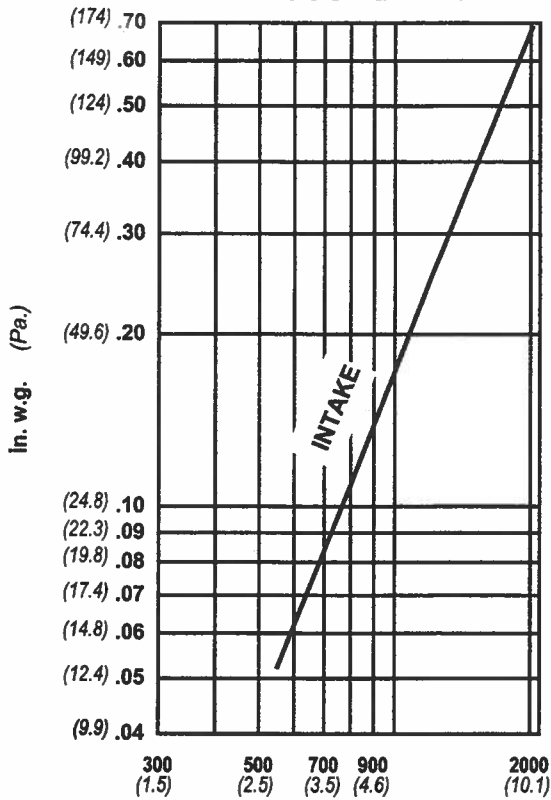

VELOCITY THROUGH FREE AREA FPM (meters /sec.)

standard air - .075 lbs. per cu. ft.

Ratings do not include the effect of a bird screen

FREE AREA IN SQUARE FEET (sq. meters)

		WIDTH							
		in.	12	24	36	48	60	72	84
HEIGHT	mm	304	609	914	1219	1524	1828	2133	2438
	12	.247	.568	.889	1.21	1.49	1.81	2.13	2.45
	304	.023	.053	.083	.112	.138	.168	.198	.228
	24	.761	1.75	2.74	3.72	4.59	5.58	6.56	7.55
	609	.071	.162	.254	.346	.426	.518	.610	.702
	36	1.19	2.73	4.27	5.81	7.16	8.70	10.24	11.78
	914	.110	.254	.397	.540	.665	.808	.951	1.09
	48	1.63	3.76	5.88	8.00	9.85	11.97	14.09	16.22
	1219	.152	.349	.546	.743	.915	1.11	1.31	1.51
	60	2.25	5.18	8.10	11.03	13.59	16.51	19.43	22.36
1524	.209	.481	.753	1.024	1.26	1.53	1.81	2.08	
72	2.58	5.92	9.26	12.60	15.52	18.86	22.20	25.54	
1828	.239	.550	.860	1.17	1.44	1.75	2.06	2.37	
84	3.07	7.04	11.02	15.00	18.48	22.46	26.43	30.41	
2133	.285	.654	1.02	1.39	1.72	2.09	2.46	2.83	
96	3.58	8.22	12.86	17.50	21.56	26.20	30.84	35.48	
2438	.332	.763	1.19	1.63	2.00	2.43	2.87	3.30	

WATER PENETRATION

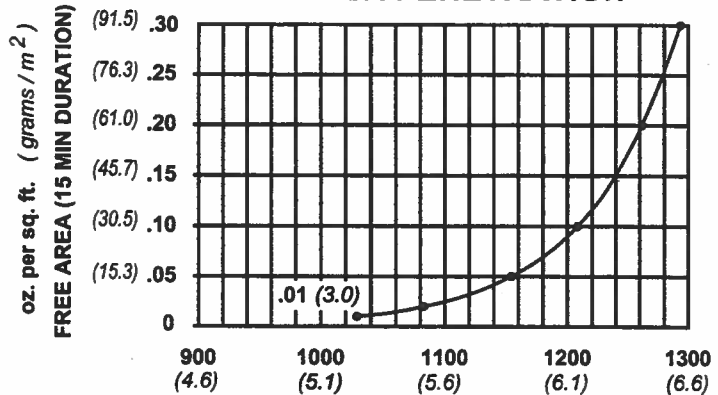

VELOCITY THROUGH FREE AREA FPM (meters /sec.)

Both maximum recommended free area velocity and beginning of water penetration are 1029 fpm at standard air - .075 lbs. per cu. ft. The above water penetration data is based on mill finish, 48" x 48" test size per AMCA Standard 511.



CESCO certifies that the model X6D4 louver shown herein is licensed to bear the AMCA Seal. The ratings shown are based on tests and procedures performed in accordance with AMCA Publication 511 and comply with the requirements of the AMCA Certified Ratings Program. The AMCA Certified Ratings Seal applies to air performance ratings and water penetration ratings.

X6D4

Below is an explanation of how to use the AMCA Performance data for the recommended free area velocity of 1029 fpm (5.22 m/s).

To determine minimum free area required for louver:

- Step #1:** Divide the required CFM flow by the maximum recommended free area velocity.
- Step #2:** Select the most desirable louver size, from the free area table, that meets the minimum free area requirement.
- Step #3:** Compare specified performance to the certified water penetration and pressure drop ratings.

Openings that require multiple louver panels in both width and height will require internal structural supports. It is recommended that large openings be divided with structural members so that the louvers will span either width or height with a single panel. Unusually high wind loading may require structural supports on non-multiple wide and multiple high assemblies. Structural supports and mounting accessories are not supplied as a standard.

Example: Given 15,000 CFM design flow
Step #1:
 min. free area = $\frac{\text{Design CFM}}{\text{Max. Recommended Velocity}}$
 $= \frac{15,000}{1029} = 14.57 \text{ sq. ft.}$

Step #2: From the free area table above the approximate louver size is 60" x 72" = (15.52 sq. ft.)