

HUMIDIN



Axial Flow Fan for extraordinary ambiance



www.humidin.com



When Quality Speaks For Itself

As a leading manufacturer of Axial Flow Fan, today HUMIDIN enjoys an an enviable position in customer mind-space.

HUMIDIN boasts of a modern plant & a talented team of qualified professionals who sets an exacting standards of quality for themselves.

In sum, HUMIDIN stands for quality & customer satisfaction that are instrumental bringing them on par with what the world calls the world class.



A.C. Humidin Air Systems certifies that the ACAP Series, model 600 to 1200 shown herein are licensed to bear the AMCA Seal. The ratings shown are based on tests and procedures performed in accordance with AMCA Publication 211 and AMCA Publication 311 and comply with the requirements of the AMCA Certified Ratings Program.





Axial Flow Fan

HUMIDIN-Axial Flow Fan are used for providing general ventilation, fume exhaust and removal of hot spots and can be as roof extractor & bifurcated fan

TYPE

- General Ventilation Purpose.
- Fire rated application & smoke exhaust

DUTIES

HUMIDIN-Axial flow-fans are specially manufactured for all applications and mounting positions in case sizes 500 to 1600 mm diameter. However small sizes fan from 300 to 450 dia can also be available on request. The performance range is from 1000 to 150000 m³ /h on air volume, at static pressure up to 1500 Pa (150mmWG).

CASING

The Casing is fabricated from mild steel sheets & plates and fitted with Flanges on both the ends. Fans are available in following mounting arrangements.

MOTOR

The standard A.C motors are totally enclosed fan cooled (TEFC), squirrel cage induction type suitable for ambient temperature upto 40°C, flame proof, vapour tight and other motors like class H and high temperature motors can be supplied on request.

DRIVING ARRANGEMENTS

There are two types of drives – The direct drive arrangement or V – Belt drive arrangement. We can provide coupling drive arrangement on request.

APPLICATIONS

- General Ventilation
- Fume Exhaust
- Removal hot spots
- As Roof Extractor
- As Bifurcated Fan
- Basement Ventilation
- Kitchen Exhaust
- Parking Ventilation
- Tunnel Ventilation
- Generator Ventilation
- Air Conditioning
- Humidification
- In line applications
- Man cooler

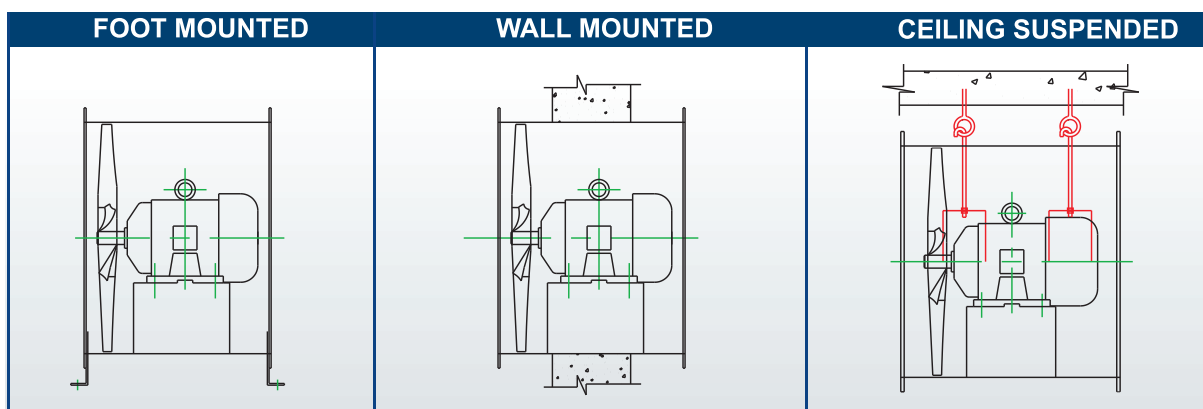

IMPELLER

HUMIDIN-impellers, hubs and blades are made of die cast aluminium alloy, the aerodynamic profile guarantees high efficiency and low noise. The hub is fitted with taper bush assembly for easy fitting on motors and is easy in maintenance. The blades are with adjustable pitch angle to optimise the duty point.



Axial Flow Fan

ACAP-6-500

50Hz

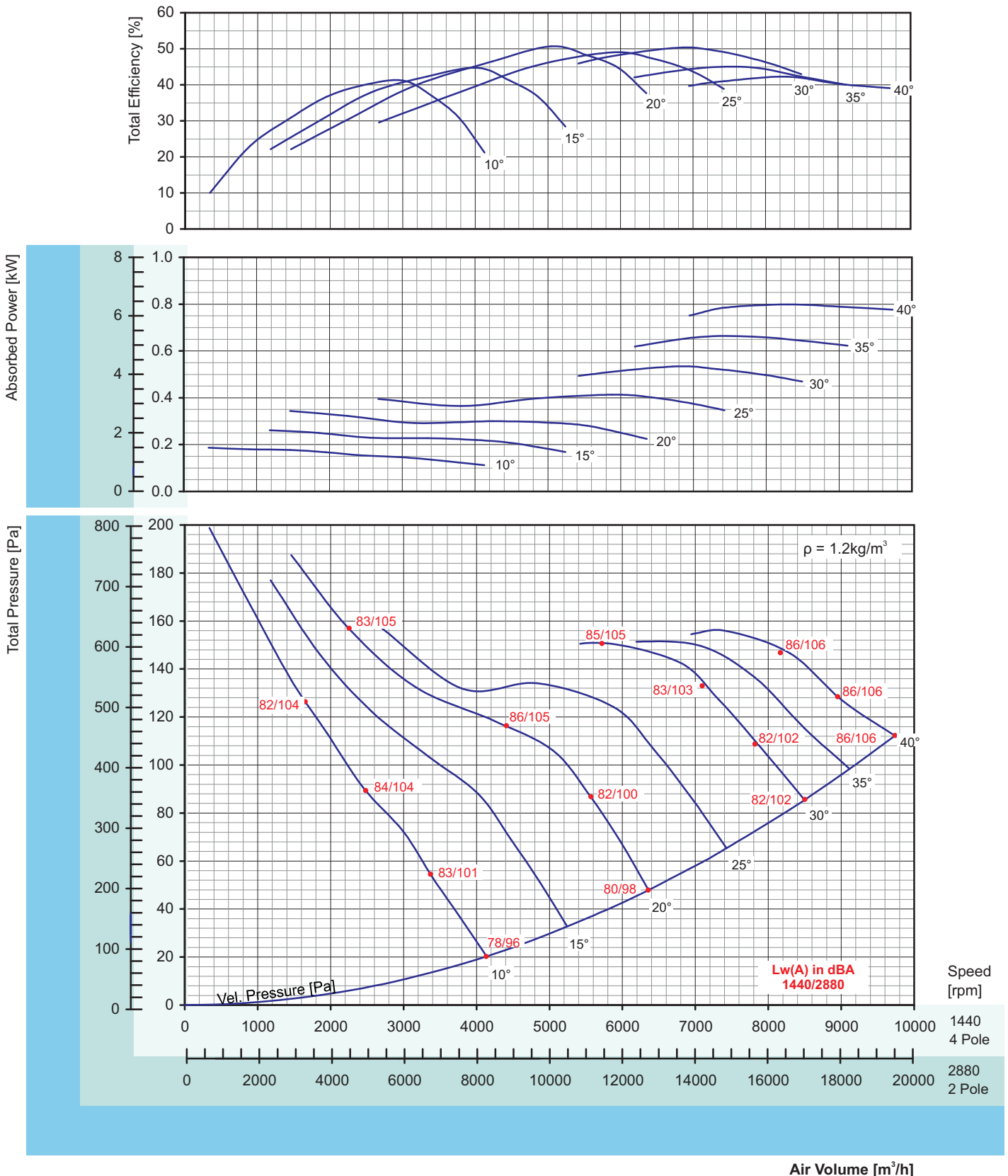

* Performance certified is for installation type D - Ducted inlet, Ducted outlet. Performance ratings do not include the effects of appurtenances (accessories).
 * The A-weighted sound ratings shown have been calculated per AMCA International Standard 301.
 * Values shown are for inlet LwiA sound power levels for installation type D: Ducted inlet, Ducted outlet. Ratings include the effects of duct end correction.
 * MODEL ACAP-6-500 IS NOT LICENSED TO BEAR THE AMCA CERTIFIED RATINGS SEAL.



Axial Flow Fan

ACAP-6-600-200

50Hz

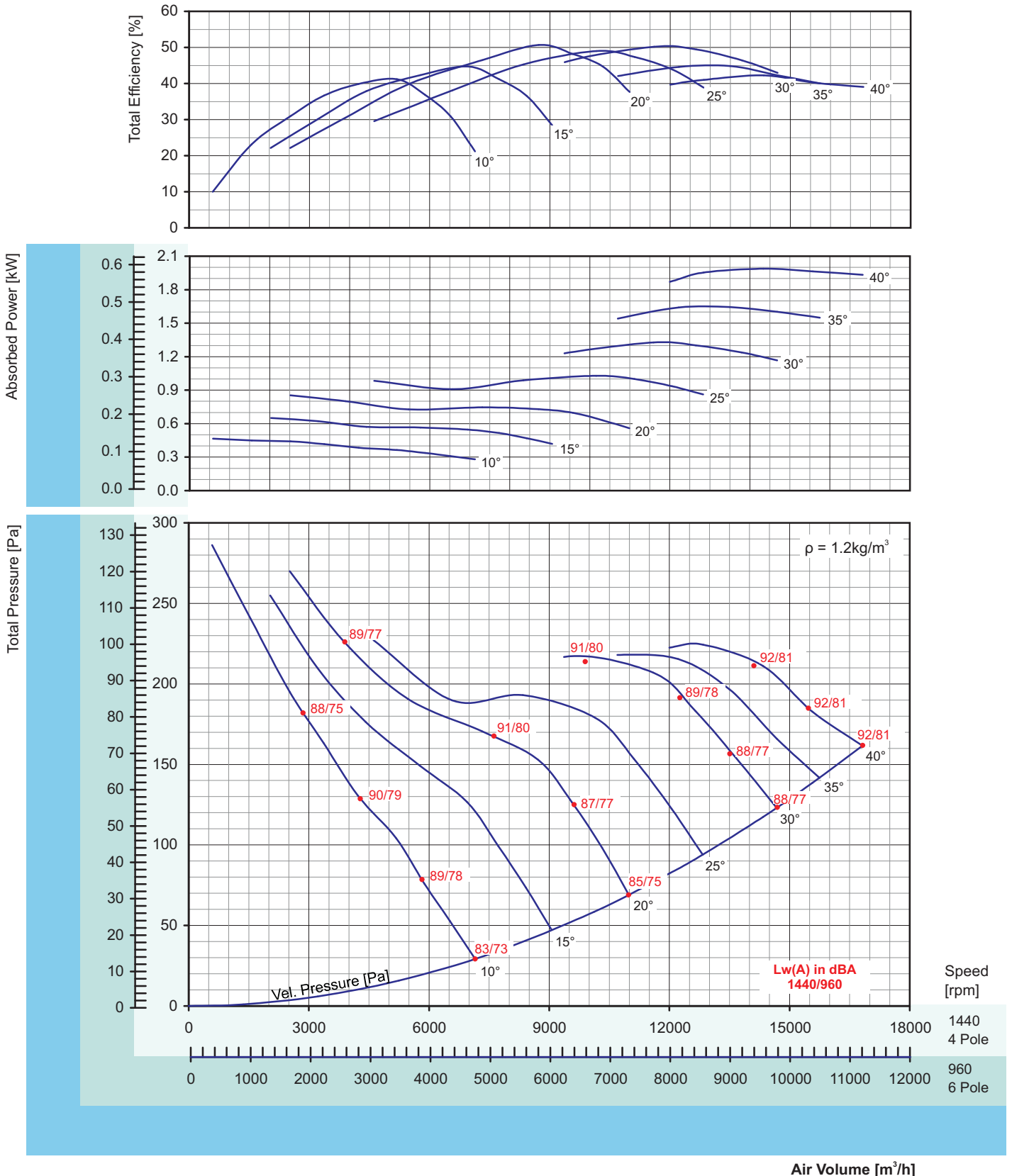

* Performance certified is for installation type D - Ducted inlet, Ducted outlet. Performance ratings do not include the effects of appurtenances (accessories).

* The A-weighted sound ratings shown have been calculated per AMCA International Standard 301.

* Values shown are for inlet LwiA sound power levels for installation type D: Ducted inlet, Ducted outlet. Ratings include the effects of duct end correction.



Axial Flow Fan

ACAP-6-700-220-30°

50Hz

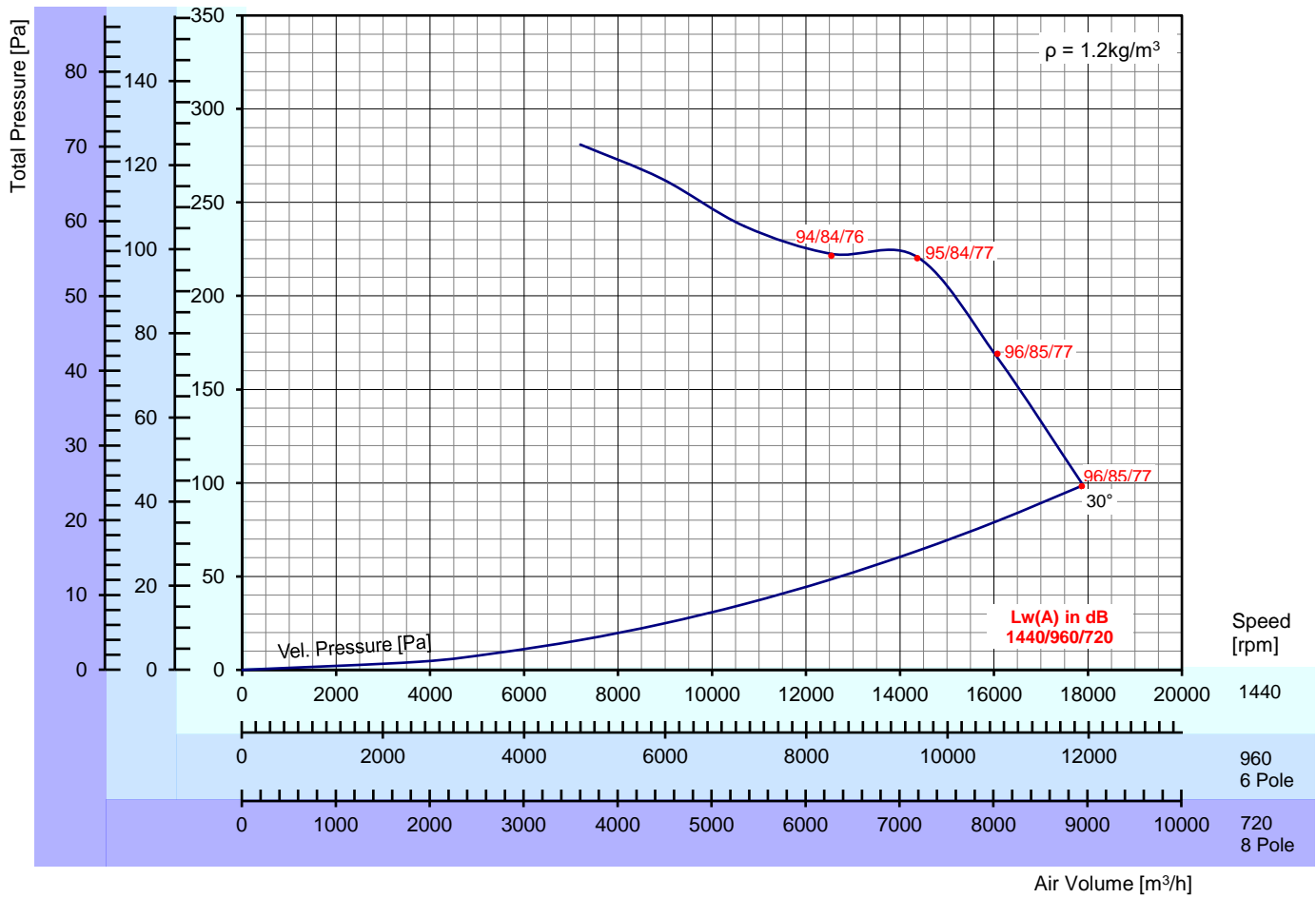
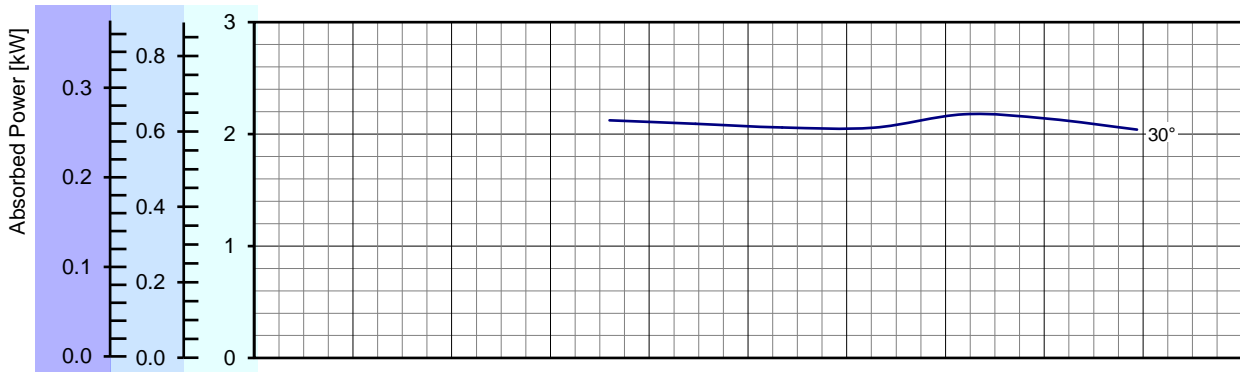
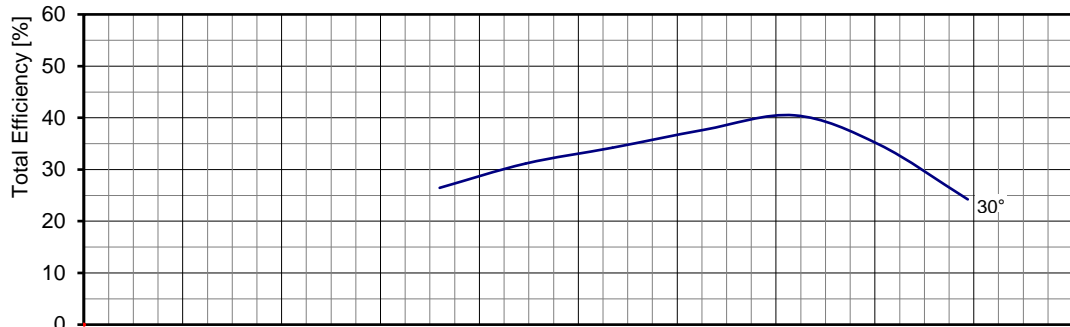

* Performance certified is for installation type D - Ducted inlet, Ducted outlet. Performance ratings do not include the effects of appurtenances (accessories).
 * The A-weighted sound ratings shown have been calculated per AMCA International Standard 301.
 * Values shown are for inlet LwA sound power levels for installation type D: Ducted inlet, Ducted outlet. Ratings include the effects of duct end correction.



Axial Flow Fan

ACAP-6-800-250

50Hz

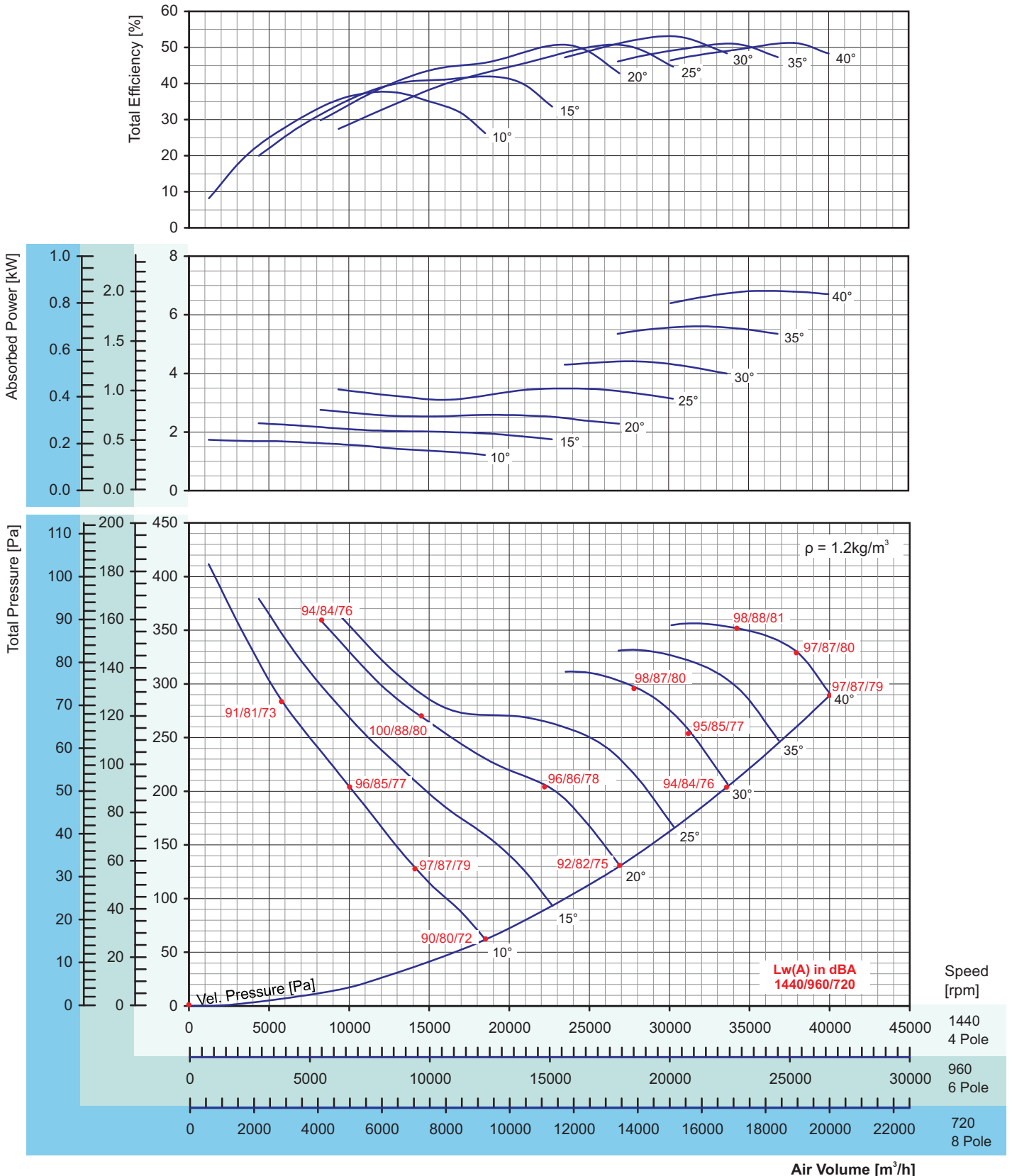

* Performance certified is for installation type D - Ducted inlet, Ducted outlet. Performance ratings do not include the effects of appurtenances (accessories).

* The A-weighted sound ratings shown have been calculated per AMCA International Standard 301.

* Values shown are for inlet LwiA sound power levels for installation type D: Ducted inlet, Ducted outlet. Ratings include the effects of duct end correction.



Axial Flow Fan

ACAP-6-900-350

50Hz

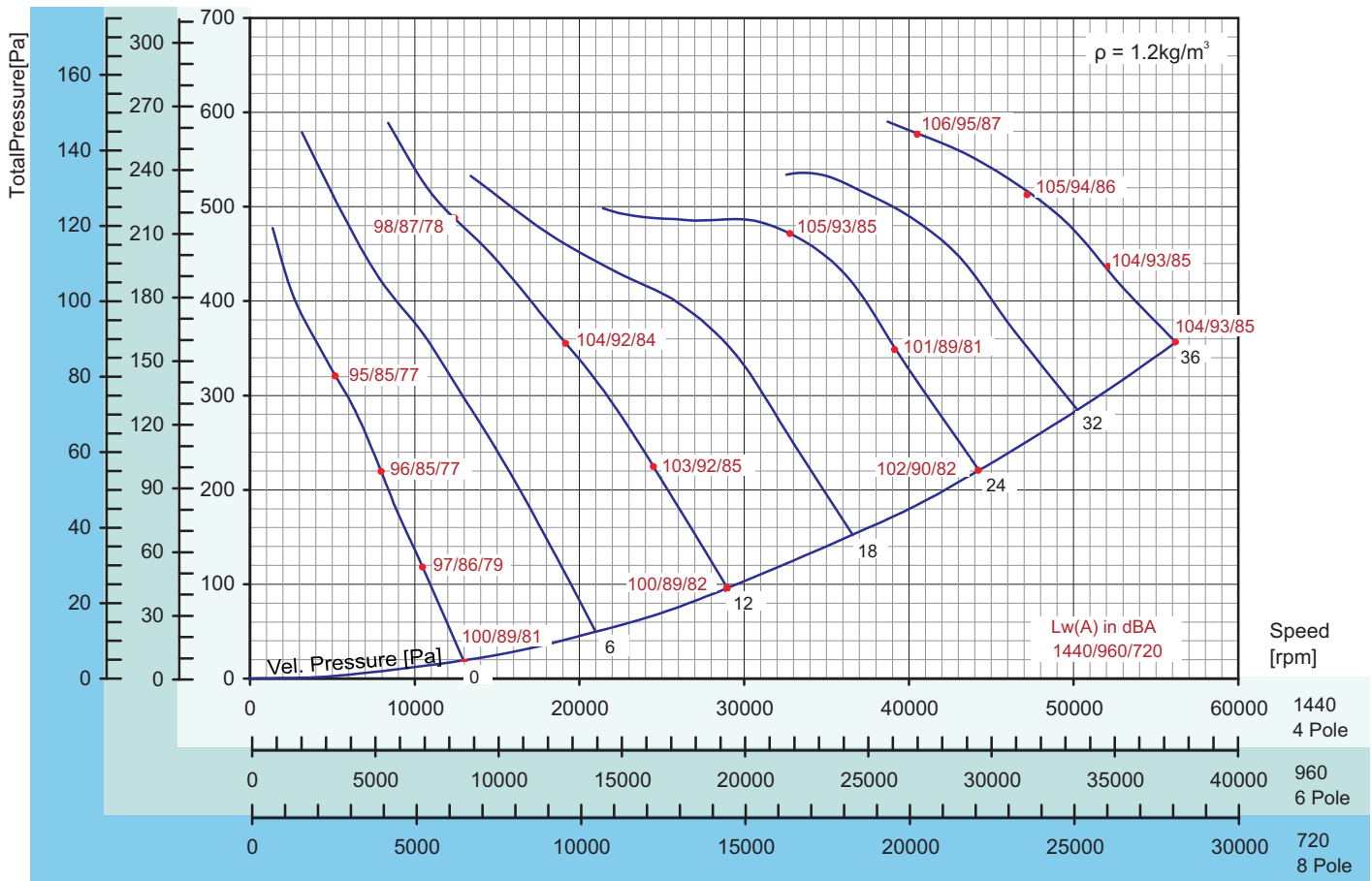
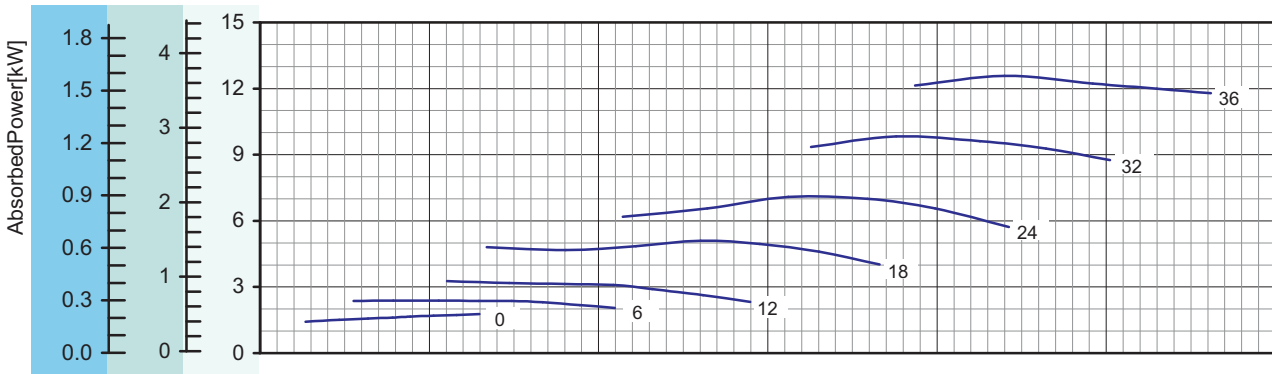
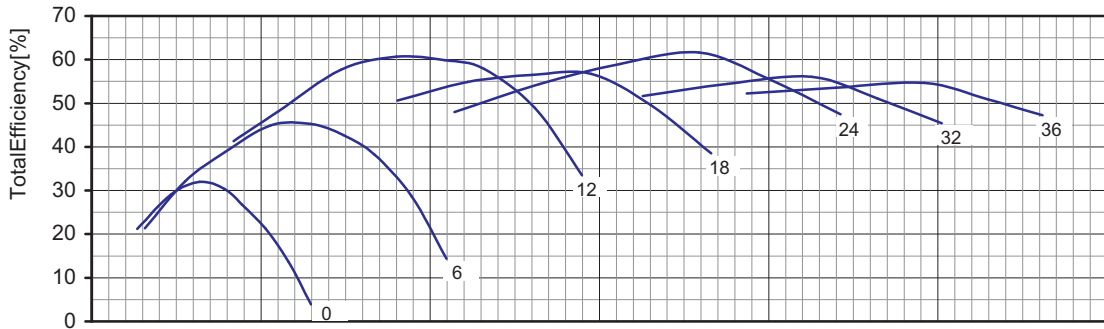

* Performance certified is for installation type D - Ducted inlet, Ducted outlet. Performance ratings do not include the effects of appurtenances (accessories).

* The A-weighted sound ratings shown have been calculated per AMCA International Standard 301.

* Values shown are for inlet LwiA sound power levels for installation type D: Ducted inlet, Ducted outlet. Ratings include the effects of duct end correction.



Axial Flow Fan

ACAP-6-1000-350

50Hz

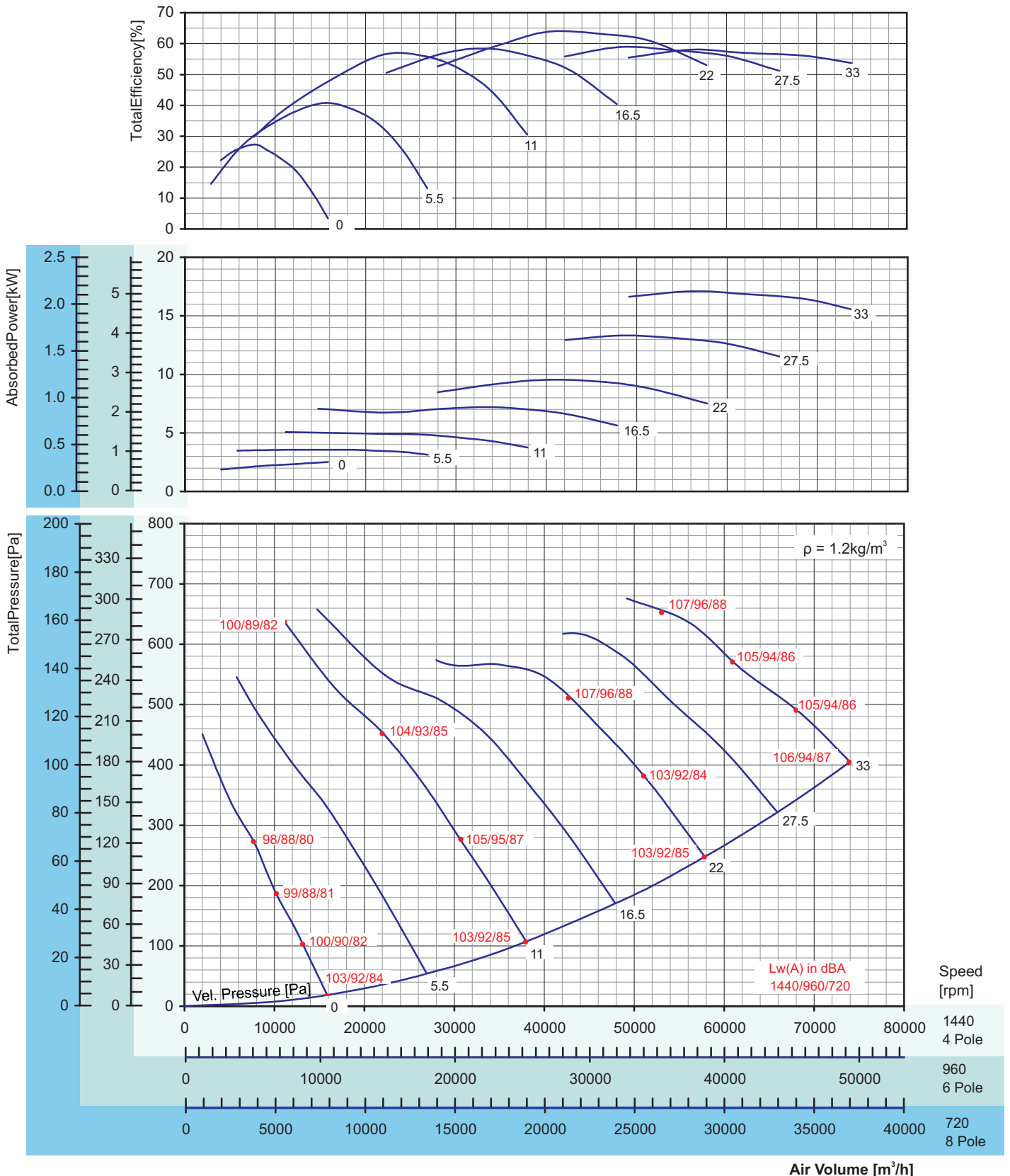

* Performance certified is for installation type D - Ducted inlet, Ducted outlet. Performance ratings do not include the effects of appurtenances (accessories).

* The A-weighted sound ratings shown have been calculated per AMCA International Standard 301.

* Values shown are for inlet Lw(A) sound power levels for installation type D: Ducted inlet, Ducted outlet. Ratings include the effects of duct end correction.



Axial Flow Fan

ACAP-6-1200-400

50Hz

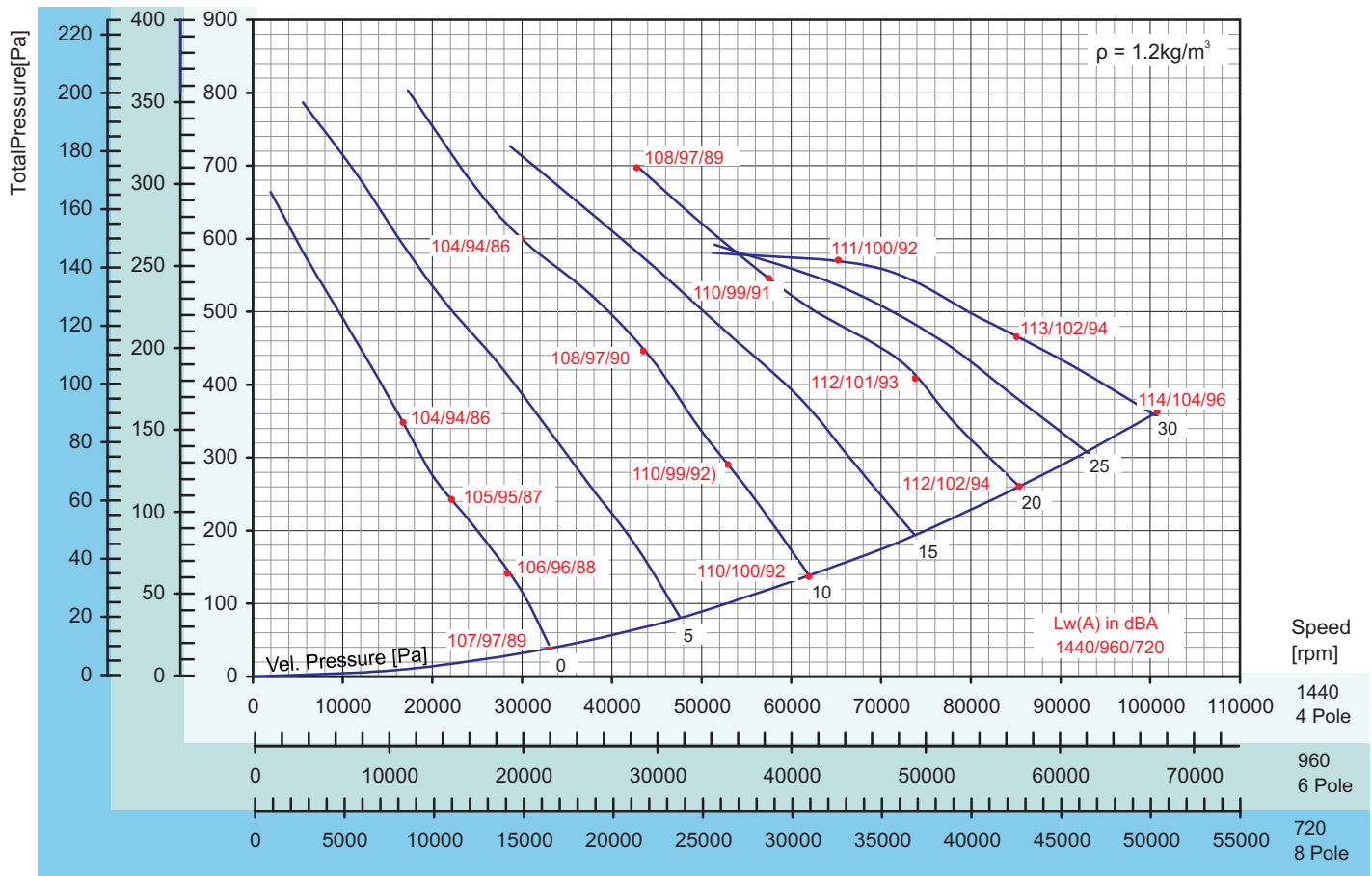
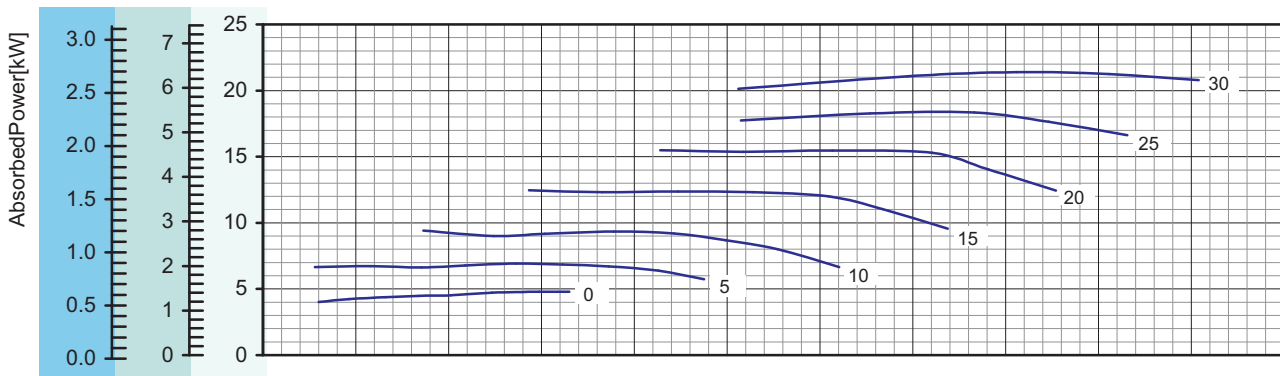
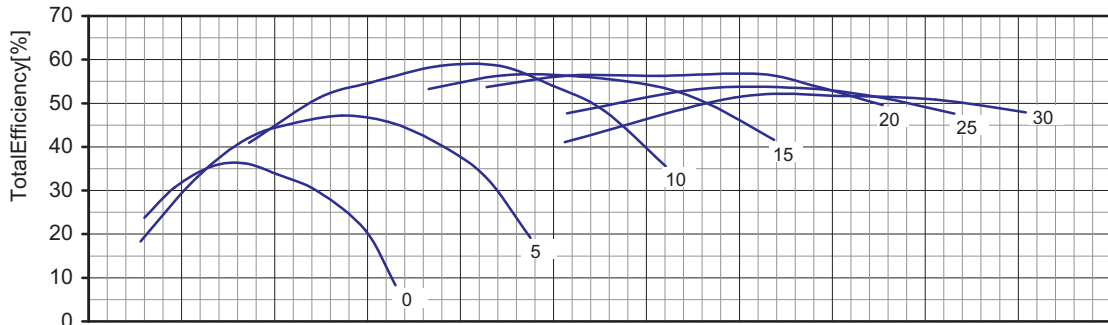

* Performance certified is for installation type A - Free inlet, Free outlet. Performance ratings do not include the effects of appurtenances (accessories).

* The A-weighted sound ratings shown have been calculated per AMCA International Standard 301.

* Values shown are for inlet LwiA sound power levels for installation type A: Free inlet, Free outlet. Ratings include the effects of duct end correction.



Axial Flow Fan

ACAP-5-1300

50Hz

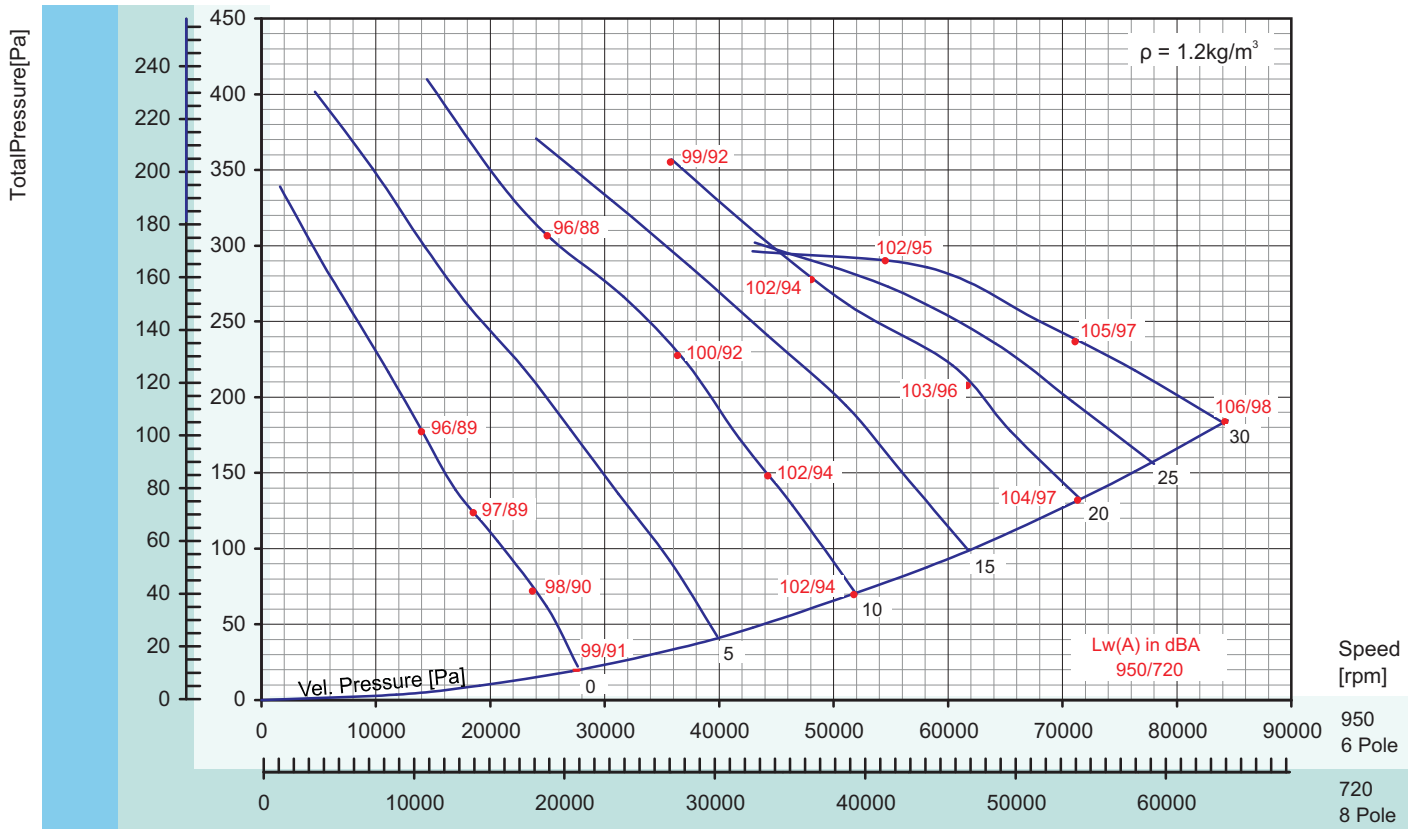
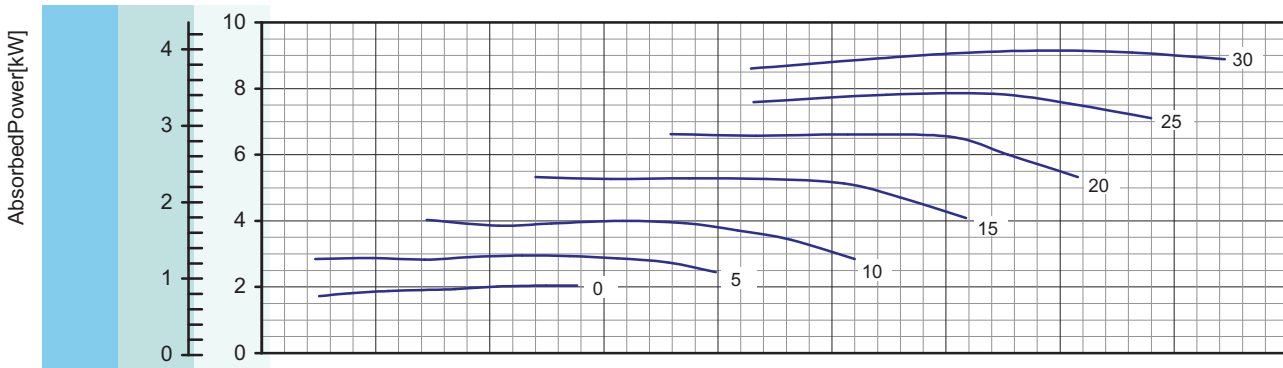
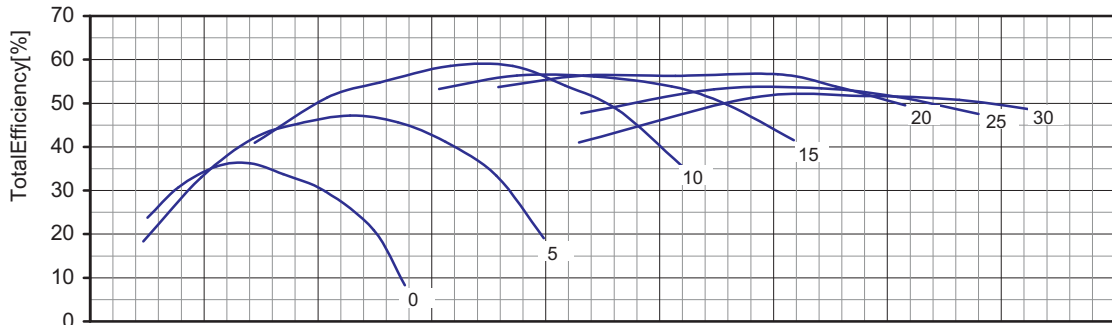

Air Volume [m³/h]

* Performance certified is for installation type A - Free inlet, Free outlet. Performance ratings do not include the effects of appurtenances (accessories).

* The A-weighted sound ratings shown have been calculated per AMCA International Standard 301.

* Values shown are for inlet Lw(A) sound power levels for installation type A: Free inlet, Free outlet. Ratings include the effects of duct end correction.

* MODEL ACAP-5-1300 IS NOT LICENSED TO BEAR THE AMCA CERTIFIED RATINGS SEAL.



Axial Flow Fan

ACAP-5-1400

50Hz

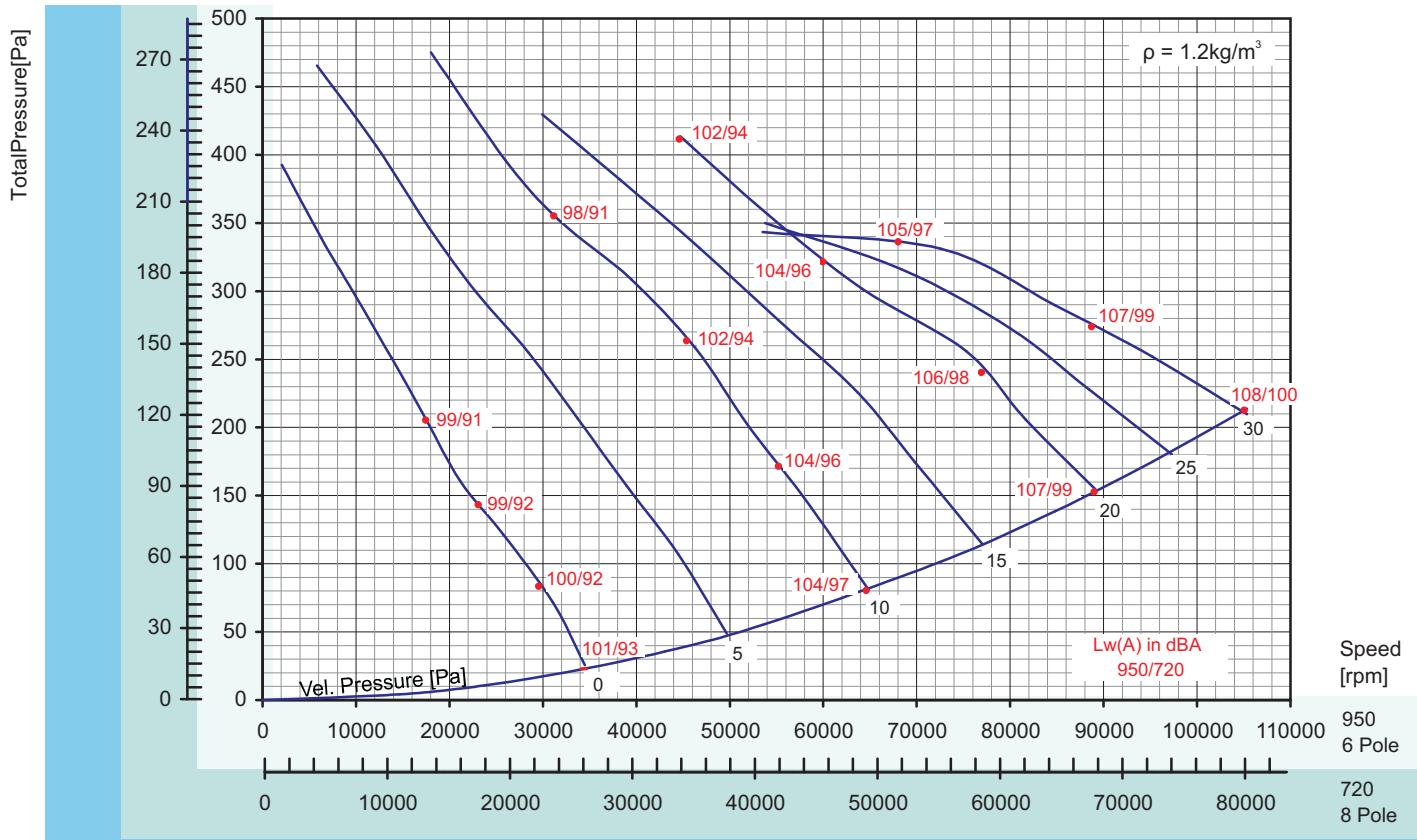
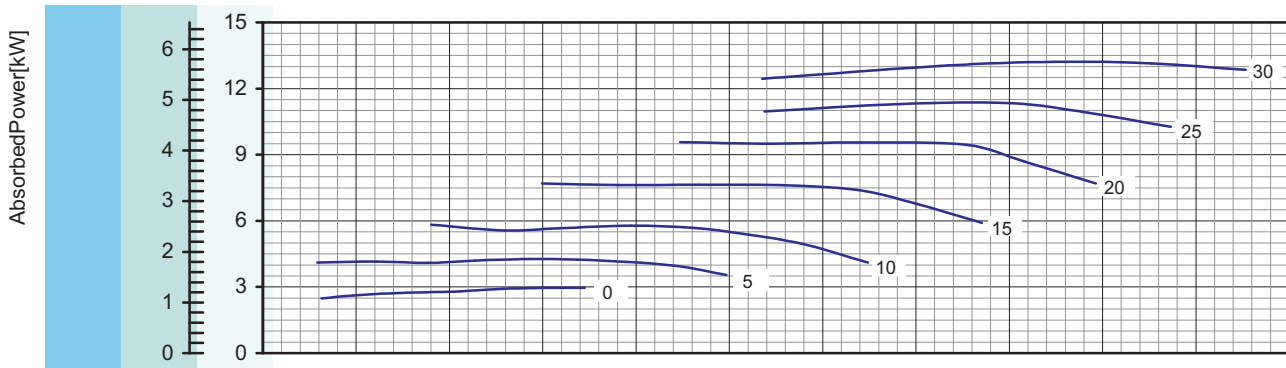
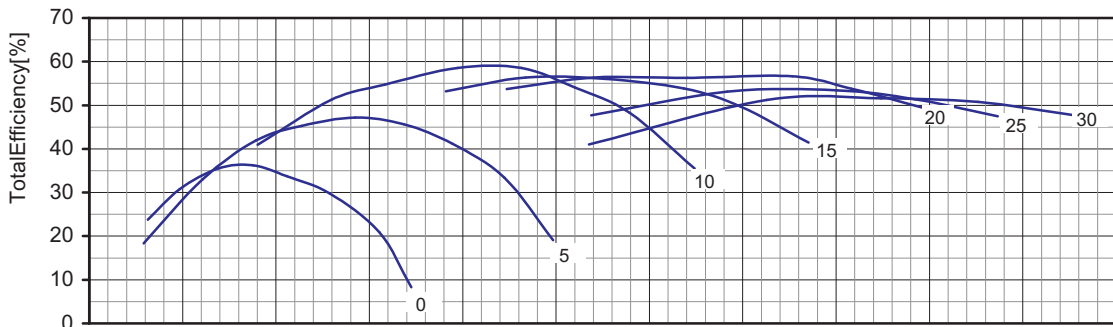

Air Volume [m³/h]

* Performance certified is for installation type A - Free inlet, Free outlet. Performance ratings do not include the effects of appurtenances (accessories).

* The A-weighted sound ratings shown have been calculated per AMCA International Standard 301.

* Values shown are for inlet Lw(A) sound power levels for installation type A: Free inlet, Free outlet. Ratings include the effects of duct end correction.

* MODEL ACAP-5-1400 IS NOT LICENSED TO BEAR THE AMCA CERTIFIED RATINGS SEAL.



Axial Flow Fan

ACAP-5-1500

50Hz

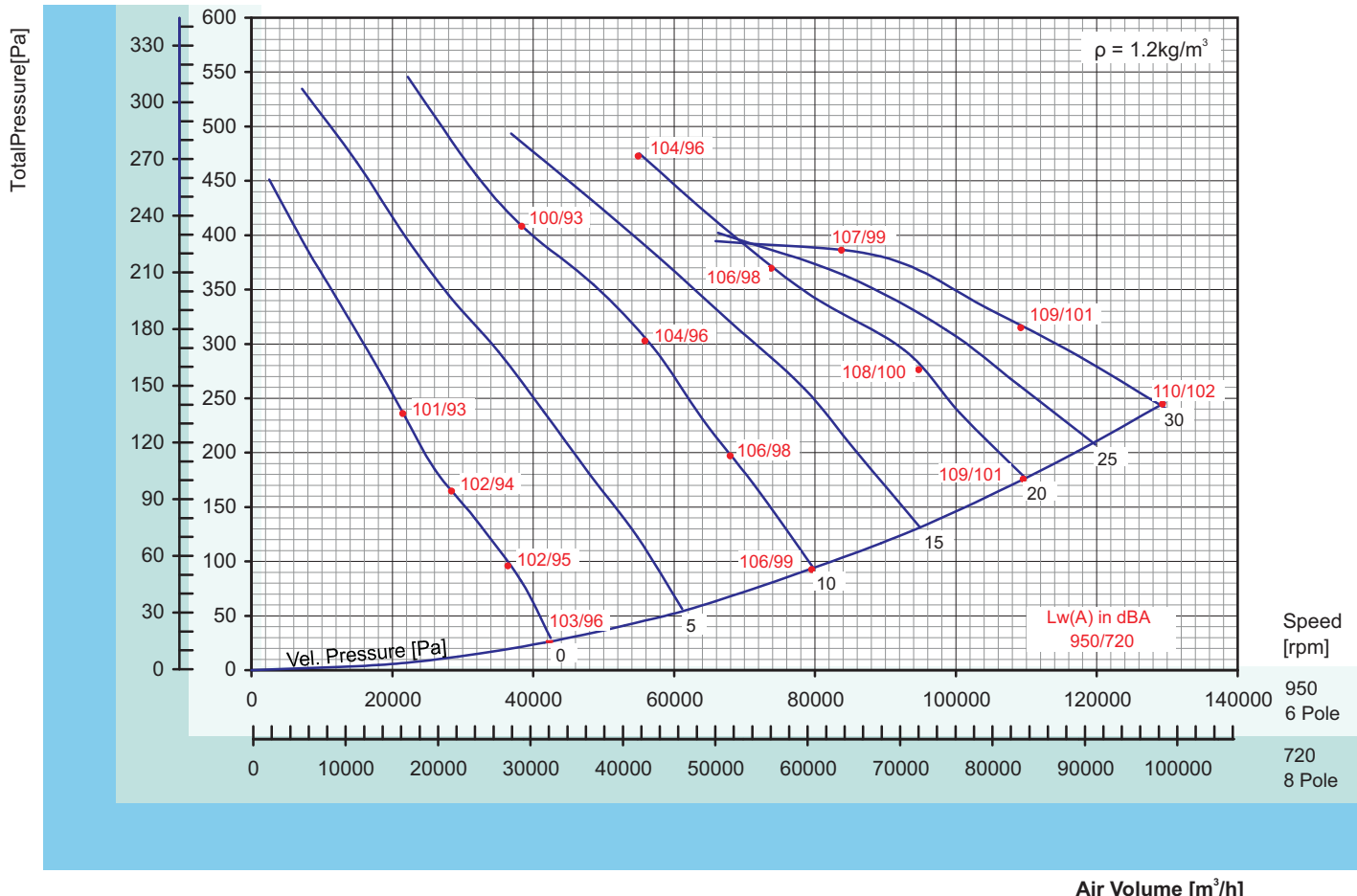
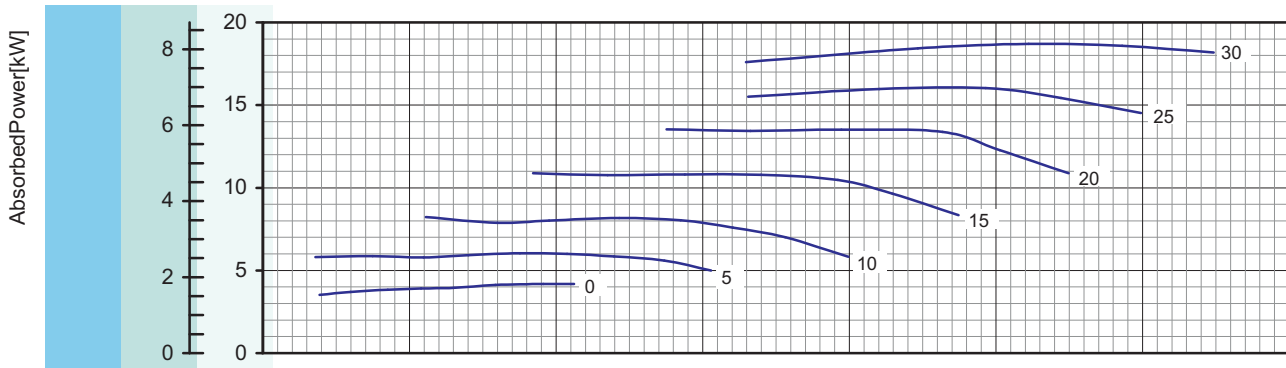
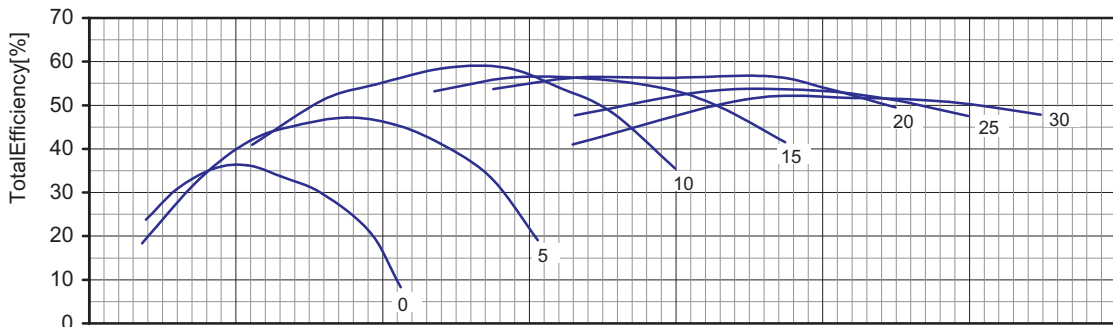

* Performance certified is for installation type A - Free inlet, Free outlet. Performance ratings do not include the effects of appurtenances (accessories).
 * The A-weighted sound ratings shown have been calculated per AMCA International Standard 301.
 * Values shown are for inlet LwA sound power levels for installation type A: Free inlet, Free outlet. Ratings include the effects of duct end correction.
 * MODEL ACAP-5-1500 IS NOT LICENSED TO BEAR THE AMCA CERTIFIED RATINGS SEAL.



Axial Flow Fan

ACAP-5-1600

50Hz

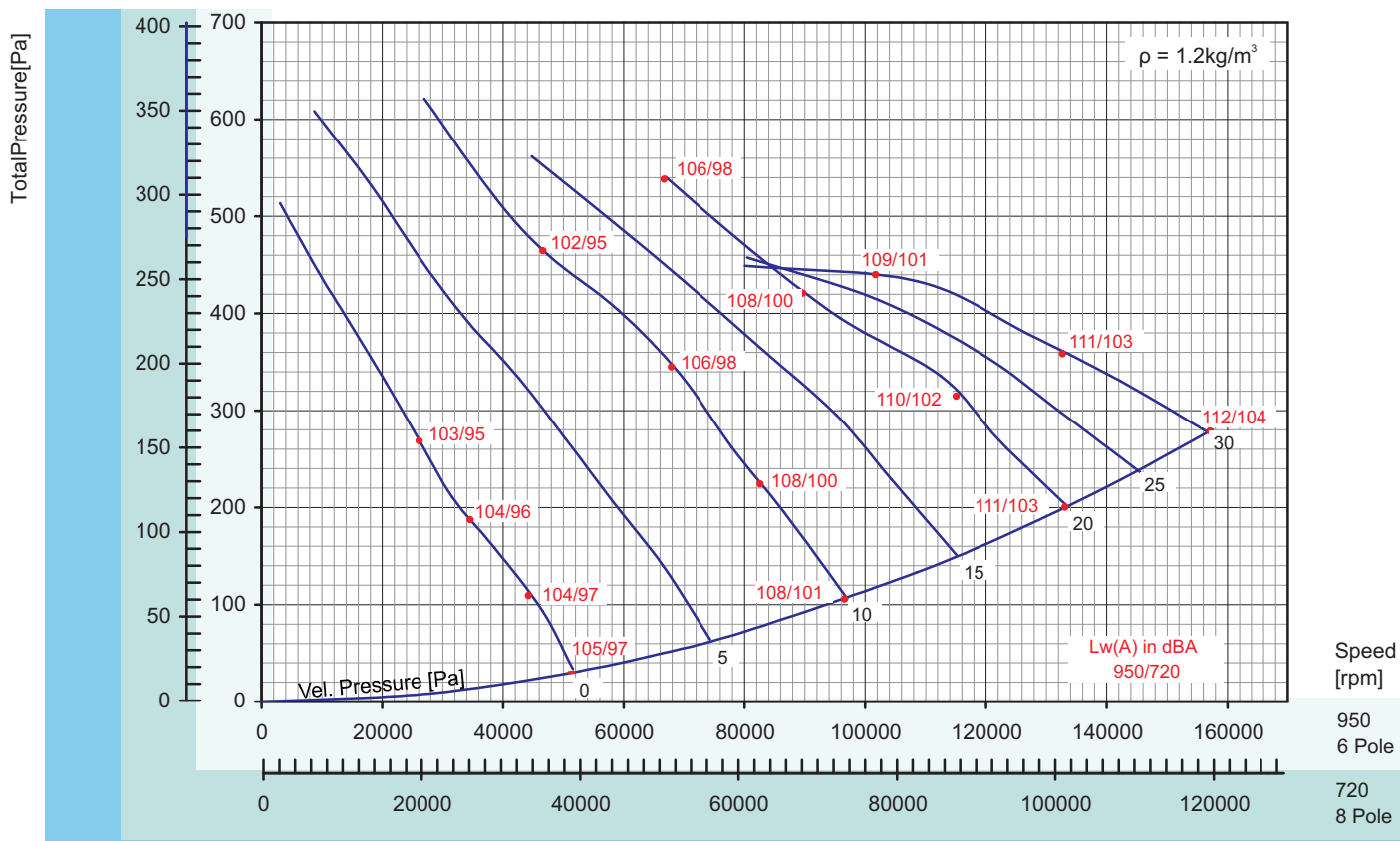
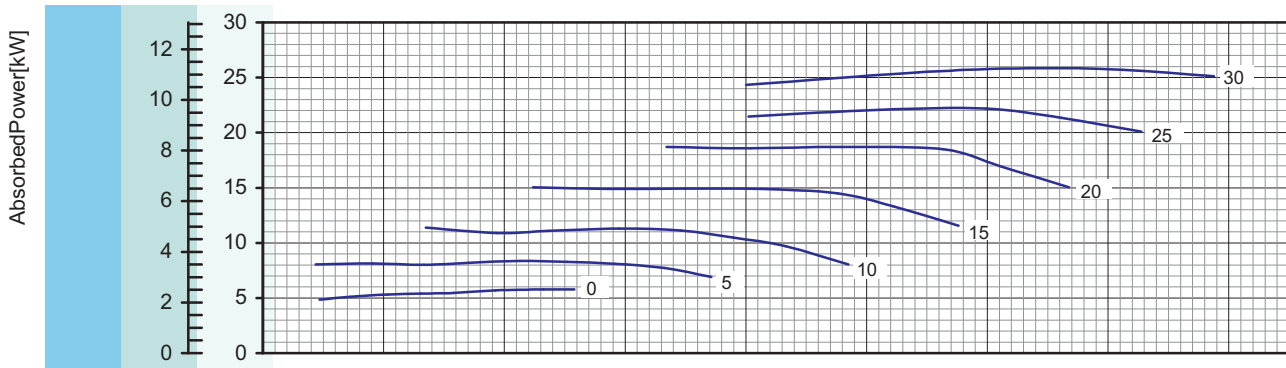
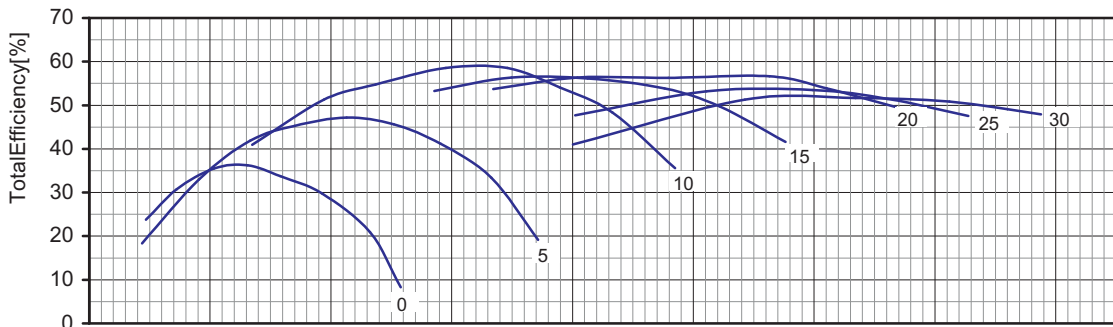

* Performance certified is for installation type A - Free inlet, Free outlet. Performance ratings do not include the effects of appurtenances (accessories).
 * The A-weighted sound ratings shown have been calculated per AMCA International Standard 301.
 * Values shown are for inlet LwiA sound power levels for installation type A: Free inlet, Free outlet. Ratings include the effects of duct end correction.
 * MODEL ACAP-5-1600 IS NOT LICENSED TO BEAR THE AMCA CERTIFIED RATINGS SEAL.



Axial Flow Fan

AXIAL FLOW FAN

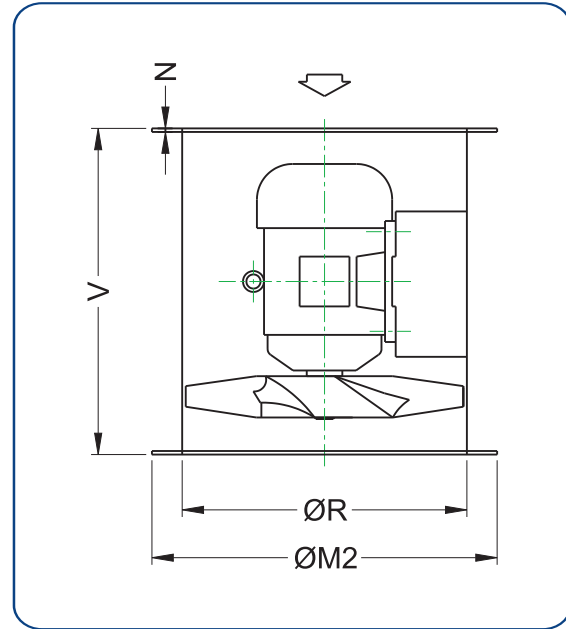
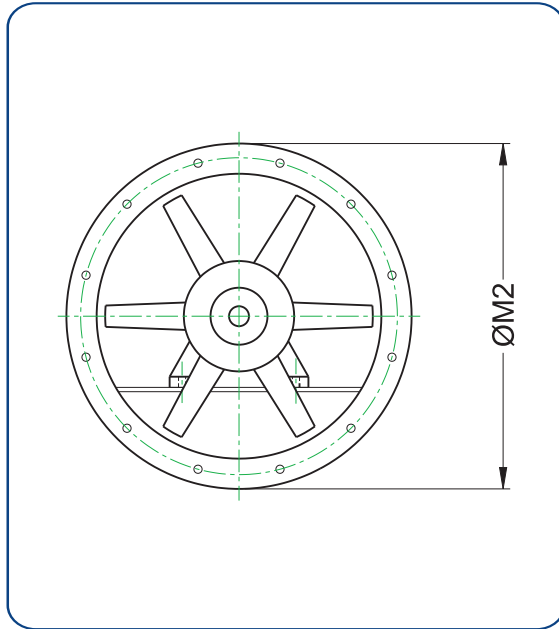

A.C. Humidin Air Systems certifies that the ACAP Series, model 600 to 1200 shown herein are licensed to bear the AMCA Seal. The ratings shown are based on tests and procedures performed in accordance with AMCA Publication 211 and AMCA Publication 311 and comply with the requirements of the AMCA Certified Ratings Program.

DIMENSION TABLE

ACAP	OM2	N	OR	V
500	585	6	500	350
600	685	6	600	430
700	785	6	700	440
800	885	6	800	560
900	985	6	900	575
1000	1085	6	1000	590
1200	1305	10	1200	680
1300	1405	10	1300	760
1400	1505	10	1400	760
1500	1605	10	1500	760
1600	1706	10	1600	800

The intention of this brochure is to introduce you to, and acquaint you with the capabilities of the HUMIDIN organization in the offered product areas. It will not answer all your immediate questions, and indeed, it will no doubt raise others. We welcome your interest in our products and shall be very pleased to provide further information.

GUARANTEE

HUMIDIN guarantees its products to be free of defects in materials and workmanship for a period of one year from the date of delivery from the factory, provided motors are properly installed with overload protector. Humidin agrees to repair or replace defective parts or part to be returned to the factory, all transportation charges prepaid. Humidin does not guarantee against abrasion, corrosion or erosion. Humidin shall not be held responsible for any charges in connection with the removal or replacement of alleged defective equipment nor for incidental consequential damages.

In accordance with our policy of continual improvement in design, we reserve the right to depart from the details given in this brochure.

A.C. HUMIDIN AIR SYSTEMS

PLOT NO: B-6, SECTOR: A-3 UPSIDC, TRONICA CITY, LONI- 201102 U.P. INDIA

PH. 0120-2696683, 2696684 FAX 0091-120-2696677

Email: info@humidin.com